

Features

Regulated Converters

- 20W 2" x 2" Package (50.8x50.8x21.0mm)
- 1kVDC Isolation
- Wide Input 2:1
- Regulated Output
- UL94V-0 Package Material
- Continuous Short Circuit Protection
- No External Components Required
- Six-Side Shielded Case
- 100% Burned In
- Industry Standard Package
- Remote ON/OFF and Trim
- Efficiency to 85%

ECONOLINE

DC/DC-Converter

REC20-S_DRWB Series

20 Watt

2" x 2"

Single &

Dual Output



Selection Guide

Part Number	Input Voltage (VDC)	Output Voltage (VDC)	Output Current (mA)	Input Current ¹⁾ (mA)		Efficiency ²⁾ (%)
				Full Load	No Load	
REC20-1205SRWB	9-18	5	4.000	2.083	30	80
REC20-1212SRWB	9-18	12	1.667	2.058	30	81
REC20-1215SRWB	9-18	15	1.333	2.058	28	81
REC20-2405SRWB	18-36	5	4.000	1.041	18	80
REC20-2412SRWB	18-36	12	1.667	980	18	85
REC20-2415SRWB	18-36	15	1.333	980	18	85
REC20-4805SRWB	36-72	5	4.000	521	10	80
REC20-4812SRWB	36-72	12	1.667	508	9	82
REC20-4815SRWB	36-72	15	1.333	508	9	82
REC20-1205DRWB	9-18	±5	±2.000	2.083	30	80
REC20-1212DRWB	9-18	±12	±833	2.033	30	82
REC20-1215DRWB	9-18	±15	±667	2.033	28	82
REC20-2405DRWB	18-36	±5	±2.000	1.041	18	80
REC20-2412DRWB	18-36	±12	±833	980	18	85
REC20-2415DRWB	18-36	±15	±667	980	18	85
REC20-4805DRWB	36-72	±5	±2.000	521	10	80
REC20-4812DRWB	36-72	±12	±833	508	9	82
REC20-4815DRWB	36-72	±15	±667	508	9	82

Notes:

1. at Nominal Input Voltage.

2. at Nominal Input Voltage and Full Load.

Specifications (Core Operating Area)

Input Voltage Range		2:1	
Output Voltage Accuracy		±2% max.	
Line Regulation (HL-LL)		±0.2% max.	
Load Regulation (for output load current change from 20% to 100%)		±0.2% max.	
Over Voltage Protection		Built-In	
External Trim Adjustment Range		±10%	
Ripple and Noise (0,1µF capacitor on output, 20MHz BW)		100mVp-p max.	
Switching Frequency at Full Load		100kHz typ.	
Input Filter		Pi Network	
Efficiency at Full Load		75% min.	
Isolation Voltage	(tested for 1 second)	1.000VDC min.	
Rated Working Voltage	(long term isolation)	see Application Notes	
Isolation Capacitance		1200pF max.	
Isolation Resistance		1 GΩ min.	
Short Circuit Protection		Continuous	
Operating Temperature (free air convection)		-25°C to +71°C (see Graph)	
Storage Temperature Range		-55°C to +100°C	
Relative Humidity	MSL Level 1	95% RH	
Case Material		Six-Side Shielded Case	
Package Weight		110 g	
MTBF (+25°C)	} Detailed Information see Application Notes chapter "MTBF"	using MIL-HDBK 217F	700 x 10 ³ hours
(+71°C)		using MIL-HDBK 217F	560 x 10 ³ hours

Derating-Graph (Ambient Temperature)

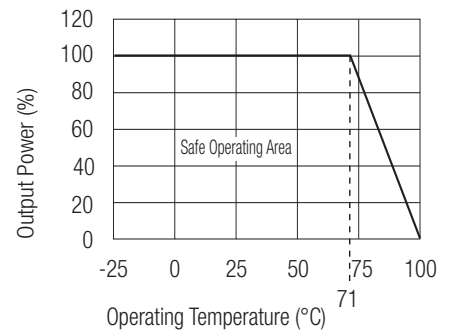

Simplified Schematic

Single Output

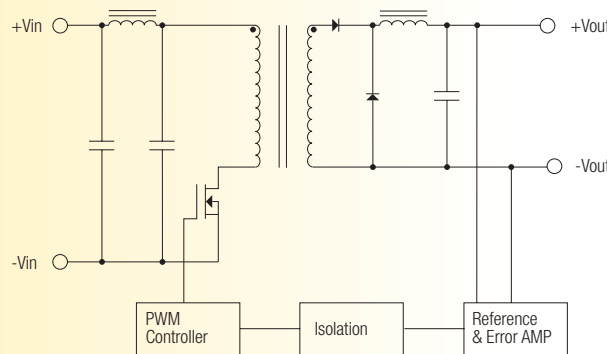

Dual Output

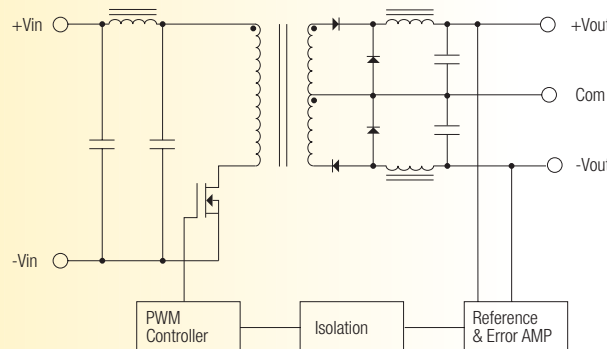

Typical Characteristics

Single Output

Dual Output

Fixed Voltage Output

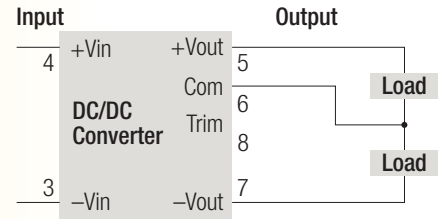
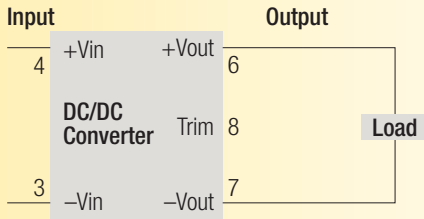

Trim Connections Using a Trimpot

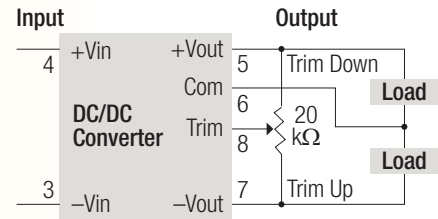
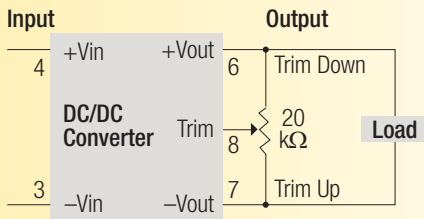

Fixed-Value Trim Down Resistor

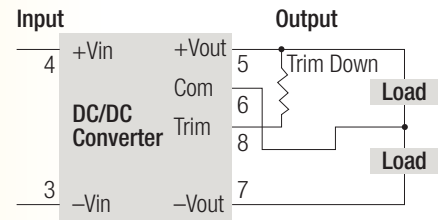
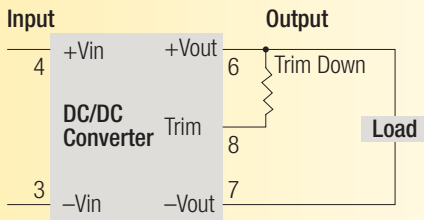

Fixed-Value Trim Up Resistor

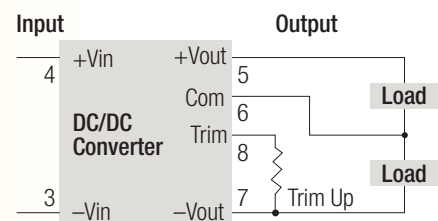
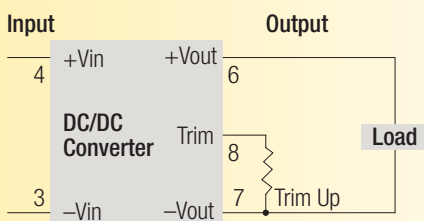

Typical Characteristics

REC20 - types

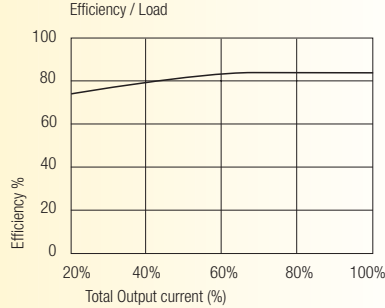

Package Style and Pinning (mm) 2" x 2", Wide Input 2:1

2" x 2" PIN Package

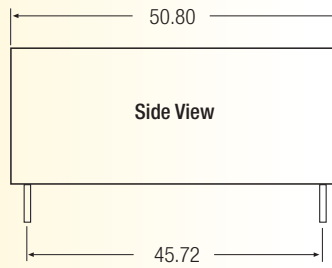
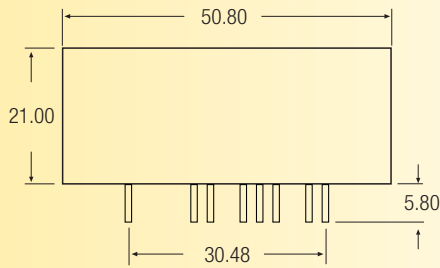

Recommended Footprint Details

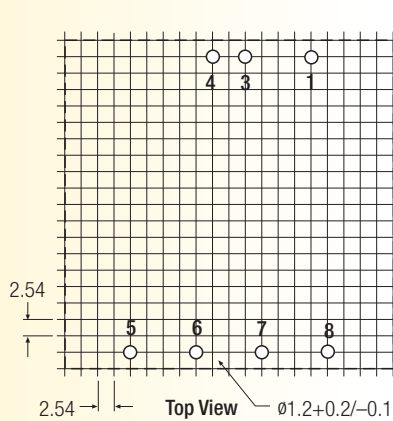
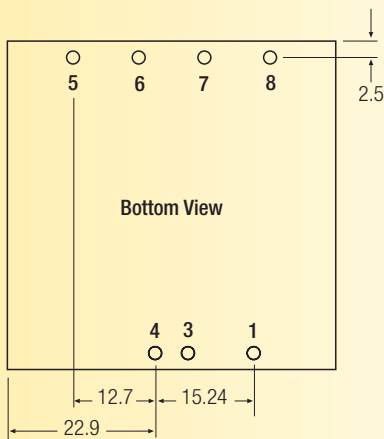

Pin Connections

Pin #	Single	Dual
1	Remote On/Off	Remote On/Off
3	-Vin	-Vin
4	+Vin	+Vin
5	No Pin	+ Vout
6	+ Vout	Com
7	- Vout	- Vout
8	Trim	Trim

XX.X ± 0.5 mm
XX.XX ± 0.25 mm

Remote On/Off Control

Control Input	Pin 1	Control Common	Pin 3
Control Voltage		Converter Shutdown Idle Current	10mA
ON	> +2.5VDC or Open Circuit	Logic Compatibility	CMOS or Open
Off	> +0.8VDC or Jumper to Pin 3		Collector TTL