

*ASSP Mobile Communication Systems***SAW Dual Filter
(700 to 2000 MHz)****G5/G6 Series (L2/D2 type)****DESCRIPTION**

As the market for handheld phones continues to increase, so has demand for smaller size, lighter weight and lower cost. Dual band phones, such as GSM + PCN and AMPS + PCS, are rising in popularity. To support these requests, Fujitsu has developed a new series of SAW dual filter (G5/G6 series) incorporating two SAW filters in one package.

For example, Fujitsu can offer a GSM Rx filter and a PCN Rx filter of combination in small 3.8 mm sq. package. The G5/G6 series of SAW dual filter applies to the 700 to 2000 MHz, frequency range, and are available in two package types: 2 input/2 output type or 1 input/2 output (2 input/1 output).

FEATURES

- Two functions are incorporated in one package
(Useful for multi-band phone and multi-mode phone)
- Ultra compact and light package (3.8 mm sq. or 3.0 mm sq.)
- 50 Ω of input/output impedance
- Low insertion loss
- 2 in/2 out and 1 in/2 out (2 in/1 out) of package types are available

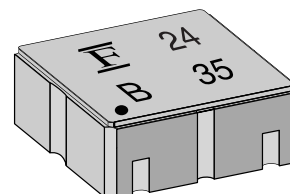
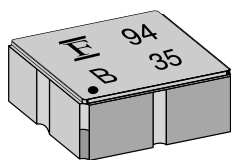
PACKAGES

G5/G6 Series

■ PIN ASSIGNMENTS

<BOTTOM VIEW>

G5CN package

G6CH package

1 in/2 out type

Pin	Pin name	Description
1	IN	Input Pin (Common)
2	GND	Ground Pin
3	GND	Ground Pin
4	GND	Ground Pin
5	OUT	Filter 2 Output Pin
6	GND	Ground Pin
7	OUT	Filter 1 Output Pin
8	GND	Ground Pin

2 in/2 out type

Pin	Pin name	Description
1	IN	Filter 1 Input Pin
2	GND	Ground Pin
3	IN	Filter 2 Input Pin
4	GND	Ground Pin
5	OUT	Filter 2 Output Pin
6	GND	Ground Pin
7	OUT	Filter 1 Output Pin
8	GND	Ground Pin

■ INTERNAL BLOCK DIAGRAM

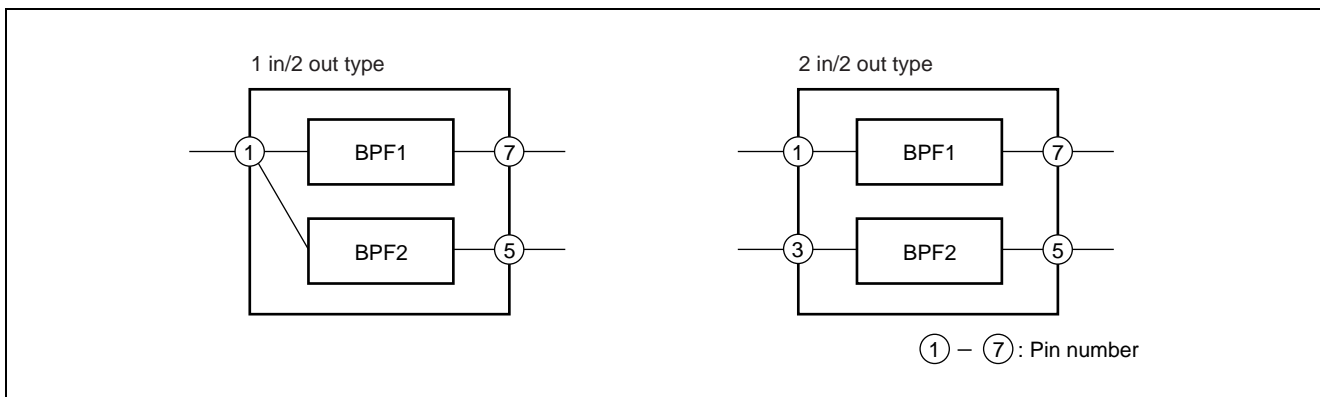

G5/G6 Series

■ ABSOLUTE MAXIMUM RATINGS

Item	Symbol	Rating		Unit
		Min.	Max.	
Operating temperature	Ta	-30	+85	°C
Storage temperature	Tstg	-40	+100	°C
Maximum DC voltage	DC	-5	+5	V
Maximum input power	P _{IN}	Depends on each design. See "■ ELECTRICAL CHARACTERISTICS".		

WARNING: Piezoelectric devices can be permanently damaged by application of stress (voltage, current, temperature, etc.) in excess of absolute maximum ratings. Do not exceed these ratings.

■ RECOMMENDED OPERATING CONDITIONS

Item	Symbol	Value		Unit
		Min.	Max.	
Operating temperature	Ta	-30	+85	°C

WARNING: The recommended operating conditions are required in order to ensure the normal operation of the piezoelectric device. All of the device's electrical characteristics are warranted when the device is operated within these ranges.

Always use piezoelectric devices within their recommended operating condition ranges. Operation outside this range may adversely affect reliability and could result in device failure.

No warranty is made with respect to uses, operating conditions, or combinations not represented on the data sheet. Users considering application outside the listed conditions are advised to contact their FUJITSU representatives beforehand.

G5/G6 Series

■ STANDARD FREQUENCIES

No.	Part number	System	Frequency (MHz)	Part symbol	Input/Output	Remarks
1	FAR-G5CN-942M50-D294	PDC800 Tx	893 to 898 MHz	94	1 in/ 2 out	
			925 to 960 MHz			
2	FAR-G5CN-877M50-D292	PDC800 Rx	810 to 843 MHz	92	1 in/ 2 out	
			870 to 885 MHz			
3	FAR-G6CH-1G8800-L214	AMPS Tx (TDMA, CDMA) PCS Tx	824 to 849 MHz	14	2 in/ 2 out	
			1850 to 1910 MHz			
4	FAR-G6CH-1G9600-L215	AMPS Rx (TDMA, CDMA) PCS Rx	869 to 894 MHz	15	2 in/ 2 out	
			1930 to 1990 MHz			
5	FAR-G6CH-1G7475-L216	GSM Tx	890 to 915 MHz	16	2 in/ 2 out	
		PCN Tx	1710 to 1785 MHz			
6	FAR-G6CH-1G8425-L217	GSM Rx	935 to 960 MHz	17	2 in/ 2 out	
		PCN Rx	1805 to 1880 MHz			
7	FAR-G6CH-1G8425-L224	EGSM Rx	925 to 960 MHz	24	2 in/ 2 out	
		PCN Rx	1805 to 1880 MHz			
8	FAR-G6CH-1G9600-L219	PCN Rx	1805 to 1880 MHz	19	2 in/ 2 out	
		PCS Rx	1930 to 1990 MHz			
9	FAR-G6CH-1G8950-L210D	PCS Tx Split	Low 1850 to 1880 MHz	10	2 in/ 2 out	
			High 1880 to 1910 MHz			
10	FAR-G6CH-1G9750-L230	PCS Rx Split	Low 1930 to 1960 MHz	30	2 in/ 2 out	
			High 1960 to 1990 MHz			

G5/G6 Series

■ ELECTRICAL CHARACTERISTICS

1. PDC800 (Tx) 1 in/2 out
Part number: FAR-G5CN-942M50-D294

(Ta = -30 to +85°C)

Item	Symbol	Condition	Value			Unit	Remarks	
			Min.	Typ.	Max.			
Filter 1	Insertion Loss	IL	893 to 898 MHz	—	—	4.0	dB	-30 to +20°C
				—	2.5	3.2	dB	+20 to +85°C
	Inband Ripple	—	893 to 898 MHz	—		1.7	dB	-30 to +20°C
				—	0.2	1.0	dB	+20 to +85°C
	Absolute Attenuation	—	500 to 570 MHz	35	42	—	dB	
		—	570 to 700 MHz	30	33	—	dB	
		—	700 to 810 MHz	22	26	—	dB	
		—	810 to 875 MHz	15	20	—	dB	
		—	875 to 885 MHz	10	15	—	dB	-30 to +30°C
				7	—	—	dB	+30 to +85°C
—		925 to 1000 MHz	14	17	—	dB		
—	1000 to 1200 MHz	25	29	—	dB			
Inband VSWR	—	893 to 898 MHz	—	1.9	3.0	—		
Max. Input Power	Pin	893 to 898 MHz	—	—	15	dBm		
Filter 2	Insertion Loss	IL	925 to 960 MHz	—	3.2	4.2	dB	
	Inband Ripple	—	925 to 960 MHz	—	1.7	2.7	dB	
	Absolute Attenuation	—	500 to 630 MHz	40	45	—	dB	
		—	630 to 710 MHz	35	40	—	dB	
		—	710 to 740 MHz	30	38	—	dB	
		—	740 to 800 MHz	28	33	—	dB	
		—	800 to 885 MHz	23	28	—	dB	
		—	1000 to 1050 MHz	15	18	—	dB	
		—	1050 to 1200 MHz	28	32	—	dB	
	Inband VSWR	—	925 to 960 MHz	—	1.9	3.0	—	
Max. Input Power	Pin	925 to 960 MHz	—	—	15	dBm		

G5/G6 Series

2. PDC800 (Rx) 1 in/2 out Part number: FAR-G5CN-877M50-D292

(Ta = -30 to +85°C)

Item	Symbol	Condition	Value			Unit	Remarks	
			Min.	Typ.	Max.			
Filter 1	Insertion Loss	IL	810 to 843 MHz	—	2.6	4.0	dB	
	Inband Ripple	—	810 to 843 MHz	—	0.8	2.2	dB	
	Absolute Attenuation	—	550 to 585 MHz	40	47	—	dB	
		—	585 to 650 MHz	28	32	—	dB	
		—	650 to 780 MHz	20	24	—	dB	
		—	865 to 889 MHz	16	19	—	dB	
		—	889 to 900 MHz	19	23	—	dB	
		—	900 to 1070 MHz	20	27	—	dB	
	—	1070 to 1110 MHz	30	33	—	dB		
Inband VSWR	—	810 to 828 MHz	—	2.1	2.8	—		
Max. Input Power	Pin	810 to 828 MHz	—	—	15	dBm		
Filter 2	Insertion Loss	IL	870 to 885 MHz	—	2.7	3.5	dB	
	Inband Ripple	—	870 to 885 MHz	—	0.2	1.0	dB	
	Absolute Attenuation	—	610 to 630 MHz	40	46	—	dB	
		—	630 to 700 MHz	35	40	—	dB	
		—	700 to 840 MHz	30	27	—	dB	
		—	925 to 960 MHz	15	19	—	dB	
		—	960 to 1130 MHz	30	37	—	dB	
		—	1130 to 1145 MHz	32	35	—	dB	
	Inband VSWR	—	870 to 885 MHz	—	1.9	2.5	—	
Max. Input Power	Pin	870 to 885 MHz	—	—	15	dBm		

G5/G6 Series

3. AMPS (TDMA, CDMA) Tx + PCS Tx (2 in/2 out)
Part number: FAR-G6CH-1G8800-L214

(Ta = -30 to +85°C)

Item	Symbol	Condition	Value			Unit	Remarks	
			Min.	Typ.	Max.			
Filter 1	Insertion Loss	IL	824 to 849 MHz	—	2.7	3.6	dB	
	Inband Ripple	—	824 to 849 MHz	—	0.8	1.7	dB	
	Absolute Attenuation	—	DC to 800 MHz	35	40	—	dB	
		—	869 to 894 MHz	28	32	—	dB	
		—	1000 to 1500 MHz	35	40	—	dB	
		—	1500 to 2000 MHz	12	14	—	dB	
		—	2000 to 3000 MHz	6	8	—	dB	
	Inband VSWR	—	824 to 849 MHz	—	1.8	2.1	—	
Max. Input Power	Pin	824 to 849 MHz	—	—	15	dBm		
Filter 2	Insertion Loss	IL	1850 to 1910 MHz	—	3.2	4.3	dB	
	Inband Ripple	—	1850 to 1910 MHz	—	1.4	2.5	dB	
	Absolute Attenuation	—	DC to 1500 MHz	21	23	—	dB	
		—	1500 to 1800 MHz	23	25	—	dB	
		—	1930 to 1990 MHz	7	19	—	dB	
		—	2000 to 2100 MHz	25	28	—	dB	
		—	2200 to 3000 MHz	18	21	—	dB	
		—	3700 to 3820 MHz	18	20	—	dB	
		—	5550 to 5730 MHz	10	15	—	dB	
	Inband VSWR	—	1850 to 1910 MHz	—	1.7	2.0	—	
Max. Input Power	Pin	1850 to 1910 MHz	—	—	13	dBm		

G5/G6 Series

4. AMPS (TDMA, CDMA) Rx + PCS Rx (2 in/2 out) Part number: FAR-G6CH-1G9600-L215

(Ta = -30 to +85°C)

Item	Symbol	Condition	Value			Unit	Remarks	
			Min.	Typ.	Max.			
Filter 1	Insertion Loss	IL	869 to 894 MHz	—	3.3	4.0	dB	
	Inband Ripple	—	869 to 894 MHz	—	1.4	2.1	dB	
	Absolute Attenuation	—	DC to 800 MHz	40	45	—	dB	
		—	824 to 849 MHz	30	39	—	dB	
		—	920 to 1000 MHz	27	29	—	dB	
		—	1000 to 1500 MHz	35	38	—	dB	
		—	1500 to 2000 MHz	11	13	—	dB	
	—	2000 to 3000 MHz	7	9	—	dB		
Inband VSWR	—	869 to 894 MHz	—	1.7	2.0	—		
Max. Input Power	Pin	869 to 894 MHz	—	—	15	dBm		
Filter 2	Insertion Loss	IL	1930 to 1990 MHz	—	2.8	4.3	dB	
	Inband Ripple	—	1930 to 1990 MHz	—	0.9	2.4	dB	
	Absolute Attenuation	—	DC to 1200 MHz	21	23	—	dB	
		—	1300 to 1600 MHz	25	27	—	dB	
		—	1650 to 1850 MHz	18	20	—	dB	
		—	1850 to 1910 MHz	8	20	—	dB	
		—	2040 to 2200 MHz	25	27	—	dB	
		—	2500 to 3000 MHz	15	17	—	dB	
		—	3860 to 3980 MHz	10	13	—	dB	
	—	5790 to 5970 MHz	10	20	—	dB		
Inband VSWR	—	1930 to 1990 MHz	—	1.6	2.3	—		
Max. Input Power	Pin	1930 to 1990 MHz	—	—	13	dBm		

G5/G6 Series

5. GSM Tx + PCN Tx (2 in/2 out)
Part number: FAR-G6CH-1G7475-L216

(Ta = -30 to +85°C)

Item	Symbol	Condition	Value			Unit	Remarks	
			Min.	Typ.	Max.			
Filter 1	Insertion Loss	IL	890 to 915 MHz	—	3.1	4.0	dB	
	Inband Ripple	—	890 to 915 MHz	—	1.1	2.0	dB	
	Absolute Attenuation	—	DC to 800 MHz	40	43	—	dB	
		—	800 to 870 MHz	28	42	—	dB	
		—	935 to 960 MHz	28	30	—	dB	
		—	1000 to 1500 MHz	35	39	—	dB	
		—	1500 to 2000 MHz	13	15	—	dB	
	—	2000 to 3000 MHz	7	8	—	dB		
Inband VSWR	—	890 to 915 MHz	—	1.8	2.2	—		
Max. Input Power	Pin	890 to 915 MHz	—	—	15	dBm		
Filter 2	Insertion Loss	IL	1710 to 1785 MHz	—	3.0	4.3	dB	
	Inband Ripple	—	1710 to 1785 MHz	—	1.5	2.8	dB	
	Absolute Attenuation	—	DC to 1500 MHz	17	18	—	dB	
		—	1500 to 1670 MHz	22	24	—	dB	
		—	1805 to 1880 MHz	7	22	—	dB	
		—	1900 to 2000 MHz	25	28	—	dB	
		—	2100 to 2700 MHz	20	25	—	dB	
		—	2700 to 3000 MHz	17	20	—	dB	
		—	3420 to 3570 MHz	15	18	—	dB	
	—	5130 to 5355 MHz	15	18	—	dB		
Inband VSWR	—	1710 to 1785 MHz	—	2.1	2.4	—		
Max. Input Power	Pin	1710 to 1785 MHz	—	—	13	dBm		

G5/G6 Series

6. GSM Rx + PCN Rx (2 in/2 out) Part number: FAR-G6CH-1G8425-L217

(Ta = -30 to +85°C)

Item	Symbol	Condition	Value			Unit	Remarks	
			Min.	Typ.	Max.			
Filter 1	Insertion Loss	IL	935 to 960 MHz	—	3.3	3.7	dB	
	Inband Ripple	—	935 to 960 MHz	—	1.2	1.6	dB	
	Absolute Attenuation	—	DC to 800 MHz	40	46	—	dB	
		—	800 to 915 MHz	30	38	—	dB	
		—	980 to 1030 MHz	25	29	—	dB	
		—	1100 to 1500 MHz	35	40	—	dB	
		—	1500 to 1800 MHz	23	26	—	dB	
	—	2000 to 3000 MHz	6	8	—	dB		
Inband VSWR	—	935 to 960 MHz	—	1.8	2.1	—		
Max. Input Power	Pin	935 to 960 MHz	—	—	15	dBm		
Filter 2	Insertion Loss	IL	1805 to 1880 MHz	—	2.8	4.0	dB	
	Inband Ripple	—	1805 to 1880 MHz	—	1.1	2.3	dB	
	Absolute Attenuation	—	DC to 1500 MHz	17	18	—	dB	
		—	1500 to 1700 MHz	20	22	—	dB	
		—	1710 to 1785 MHz	11	23	—	dB	
		—	1920 to 1980 MHz	20	28	—	dB	
		—	2100 to 2600 MHz	23	26	—	dB	
		—	2600 to 3000 MHz	22	25	—	dB	
		—	3610 to 3760 MHz	15	20	—	dB	
	—	5415 to 5640 MHz	15	17	—	dB		
Inband VSWR	—	1805 to 1880 MHz	—	2.0	2.4	—		
Max. Input Power	Pin	1805 to 1880 MHz	—	—	13	dBm		

G5/G6 Series

7. EGSM Rx + PCN Rx (2 in/2 out)
Part number: FAR-G6CH-1G8425-L224

(Ta = -30 to +85°C)

Item	Symbol	Condition	Value			Unit	Remarks	
			Min.	Typ.	Max.			
Filter 1	Insertion Loss	IL	925 to 960 MHz	—	—	3.8	dB	-30 to +20°C
				—	2.8	3.0	dB	+20 to +85°C
	Inband Ripple	—	925 to 960 MHz	—	0.9	1.9	dB	
	Absolute Attenuation	—	DC to 619 MHz	25	26	—	dB	
		—	619 to 880 MHz	26	27	—	dB	
		—	880 to 915 MHz	11	27	—	dB	-30 to +30°C
				7	—	—	dB	+30 to +85°C
		—	980 to 1200 MHz	20	33	—	dB	
		—	1200 to 2400 MHz	25	27	—	dB	
	Inband VSWR	—	925 to 960 MHz	—	2.2	2.6	—	
Max. Input Power	Pin	925 to 960 MHz	—	—	15	dBm		
Filter 2	Insertion Loss	IL	1805 to 1880 MHz	—	—	4.0	dB	-30 to +20°C
				—	3.1	3.5	dB	+20 to +85°C
	Inband Ripple	—	1805 to 1880 MHz	—	1.5	2.4	dB	
	Absolute Attenuation	—	DC to 1500 MHz	17	18	—	dB	
		—	1500 to 1700 MHz	20	22	—	dB	
		—	1710 to 1785 MHz	20	25	—	dB	-30 to +30°C
				11	—	—	dB	+30 to +85°C
		—	1920 to 1980 MHz	20	29	—	dB	
		—	2100 to 2500 MHz	23	25	—	dB	
		—	2600 to 3000 MHz	22	26	—	dB	
		—	3610 to 3760 MHz	16	20	—	dB	
	—	5415 to 5640 MHz	14	16	—	dB		
	Inband VSWR	—	1805 to 1880 MHz	—	1.9	2.4	—	
Max. Input Power	Pin	1805 to 1880 MHz	—	—	13	dBm		

G5/G6 Series

8. PCN Rx + PCS Rx (2 in/2 out) Part number: FAR-G6CH-1G9600-L219

(Ta = -30 to +85°C)

Item	Symbol	Condition	Value			Unit	Remarks	
			Min.	Typ.	Max.			
Filter 1	Insertion Loss	IL	1805 to 1880 MHz	—	3.1	4.0	dB	
	Inband Ripple	—	1805 to 1880 MHz	—	1.4	2.3	dB	
	Absolute Attenuation	—	DC to 1500 MHz	17	18	—	dB	
		—	1600 to 1710 MHz	22	25	—	dB	
		—	1710 to 1785 MHz	10	24	—	dB	
		—	1920 to 1980 MHz	20	30	—	dB	
		—	2000 to 2400 MHz	25	27	—	dB	
		—	3610 to 3760 MHz	16	18	—	dB	
	—	5415 to 5640 MHz	14	16	—	dB		
Inband VSWR	—	1805 to 1880 MHz	—	2.2	2.6	—		
Max. Input Power	Pin	1805 to 1880 MHz	—	—	13	dBm		
Filter 2	Insertion Loss	IL	1930 to 1990 MHz	—	3.1	4.3	dB	
	Inband Ripple	—	1930 to 1990 MHz	—	1.2	2.4	dB	
	Absolute Attenuation	—	DC to 1500 MHz	21	23	—	dB	
		—	1500 to 1850 MHz	22	25	—	dB	
		—	1850 to 1910 MHz	8	23	—	dB	
		—	2040 to 2200 MHz	25	28	—	dB	
		—	2500 to 3000 MHz	19	21	—	dB	
		—	3860 to 3980 MHz	16	19	—	dB	
	—	5790 to 5970 MHz	8	11	—	dB		
Inband VSWR	—	1930 to 1990 MHz	—	1.5	2.3	—		
Max. Input Power	Pin	1930 to 1990 MHz	—	—	13	dBm		

G5/G6 Series

9. PCS Tx split band (low band + high band dual) (2 in/2 out)
Part number: FAR-G6CH-1G8950-L210D

(Ta = -30 to +85°C)

Item	Symbol	Condition	Value			Unit	Remarks	
			Min.	Typ.	Max.			
Filter 1	Insertion Loss	IL	1850 to 1880 MHz	—	2.0	3.2	dB	
	Inband Ripple	—	1850 to 1880 MHz	—	0.5	1.7	dB	
	Absolute Attenuation	—	DC to 1700 MHz	24	26	—	dB	
		—	1700 to 1760 MHz	25	34	—	dB	
		—	1930 to 2000 MHz	30	37	—	dB	
		—	2000 to 2500 MHz	20	29	—	dB	
	Inband VSWR	—	1850 to 1880 MHz	—	1.2	2.0	—	
Max. Input Power	Pin	1850 to 1880 MHz	—	—	13	dBm		
Filter 2	Insertion Loss	IL	1880 to 1910 MHz	—	2.1	3.2	dB	
	Inband Ripple	—	1880 to 1910 MHz	—	0.6	1.7	dB	
	Absolute Attenuation	—	DC to 1700 MHz	22	26	—	dB	
		—	1700 to 1780 MHz	25	32	—	dB	
		—	1960 to 2000 MHz	30	37	—	dB	
		—	2000 to 2500 MHz	20	28	—	dB	
	Inband VSWR	—	1880 to 1910 MHz	—	1.3	2.2	—	
Max. Input Power	Pin	1880 to 1910 MHz	—	—	13	dBm		

G5/G6 Series

10.PCS Rx split band (low band + high band dual) (2 in/2 out) Part number: FAR-G6CH-1G9750-L230

(Ta = -30 to +85°C)

Item	Symbol	Condition	Value			Unit	Remarks	
			Min.	Typ.	Max.			
Filter 1	Insertion Loss	IL	1930 to 1960 MHz	—	2.4	3.2	dB	
	Inband Ripple	—	1930 to 1960 MHz	—	0.6	1.4	dB	
	Absolute Attenuation	—	DC to 1850 MHz	20	21	—	dB	
		—	1850 to 1880 MHz	30	36	—	dB	
		—	2040 to 2070 MHz	20	30	—	dB	
		—	2500 to 3000 MHz	20	32	—	dB	
	Inband VSWR	—	1930 to 1960 MHz	—	1.7	2.1	—	
Max. Input Power	Pin	1930 to 1960 MHz	—	—	13	dBm		
Filter 2	Insertion Loss	IL	1960 to 1990 MHz	—	2.3	3.2	dB	
	Inband Ripple	—	1960 to 1990 MHz	—	0.5	1.4	dB	
	Absolute Attenuation	—	DC to 1880 MHz	20	21	—	dB	
		—	1880 to 1910 MHz	30	40	—	dB	
		—	2070 to 2100 MHz	20	31	—	dB	
		—	2500 to 3000 MHz	20	31	—	dB	
	Inband VSWR	—	1960 to 1990 MHz	—	1.7	2.1	—	
Max. Input Power	Pin	1960 to 1990 MHz	—	—	13	dBm		

G5/G6 Series

■ TYPICAL CHARACTERISTICS

1. PDC800 (Tx) 1in/2 out Part number: FAR-G5CN-942M50-D294

Filter 1 (Passband: 893 to 898 MHz)

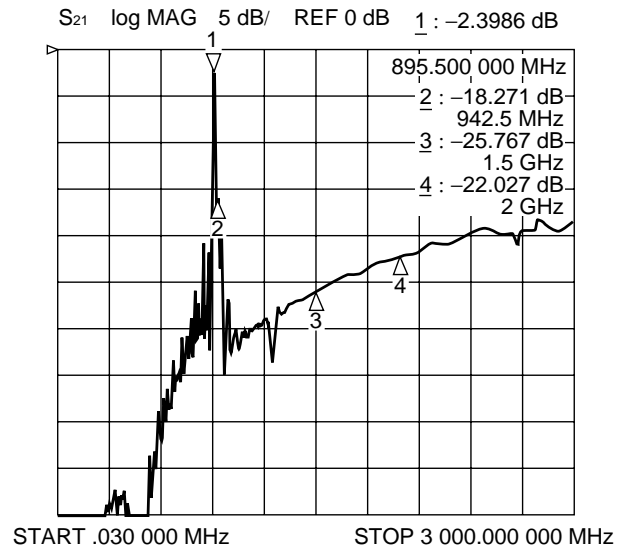
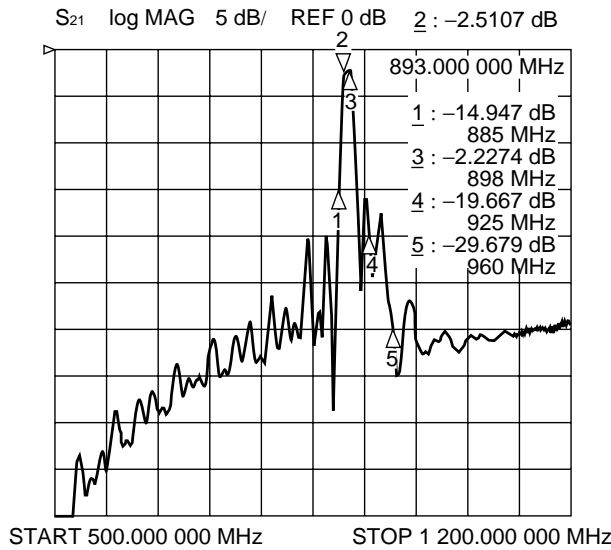

Filter 2 (Passband: 925 to 960 MHz)

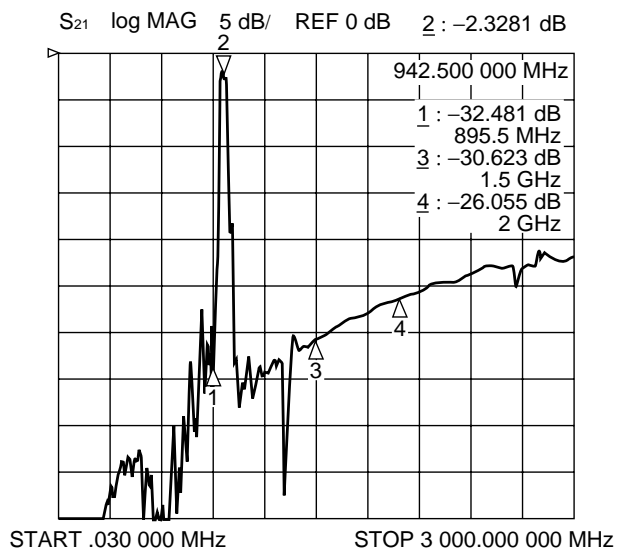
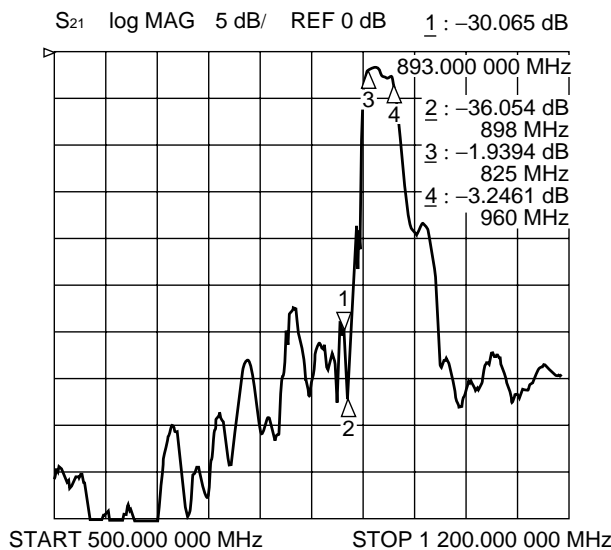

G5/G6 Series

2. PDC800 (Rx) 1in/2 out Part number: FAR-G5CN-877M50-D292

Filter 1 (Passband: 810 to 843 MHz)

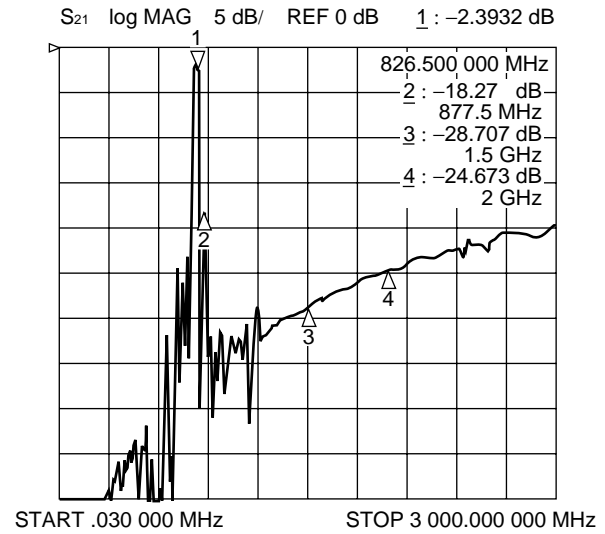
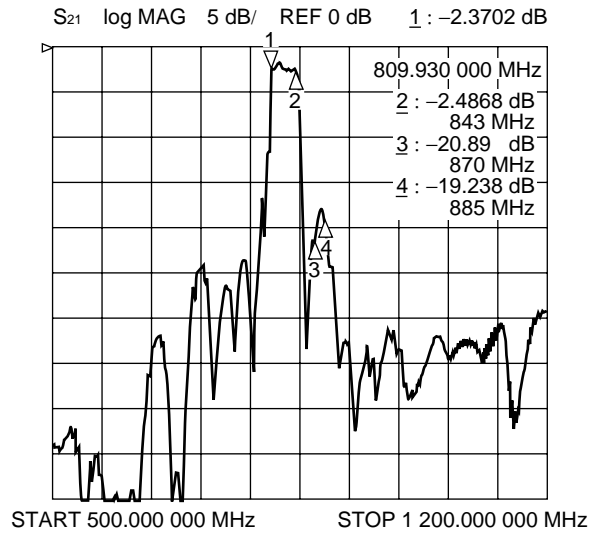

Filter 2 (Passband: 870 to 885 MHz)

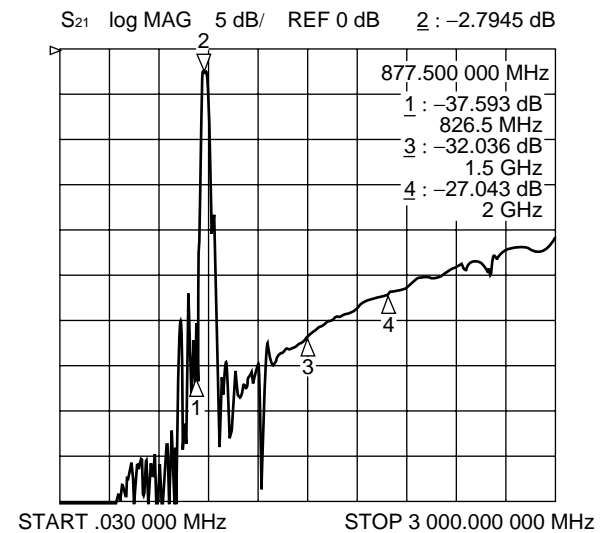
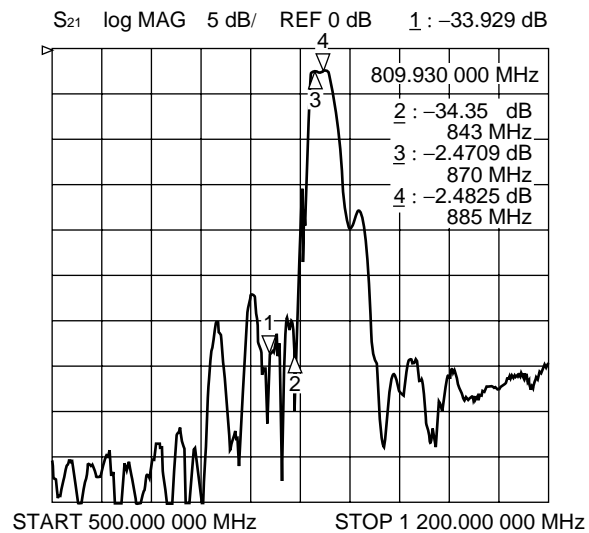

G5/G6 Series

3. AMPS (TDMA, CDMA) Tx + PCS Tx Part number: FAR-G6CH-1G8800-L214

Filter 1 (Passband: 824 to 849 MHz)

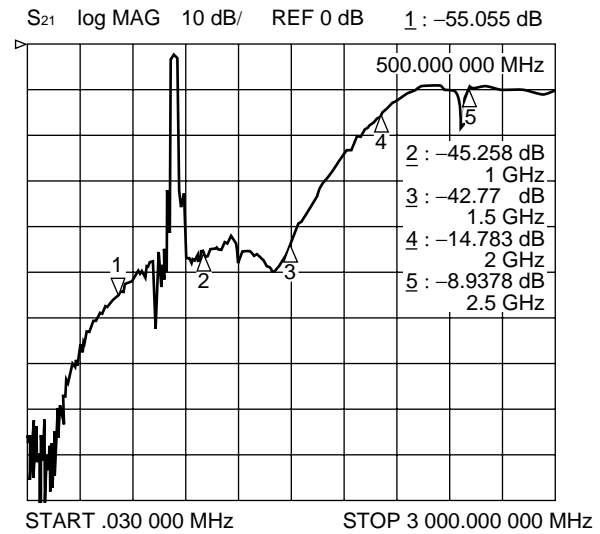
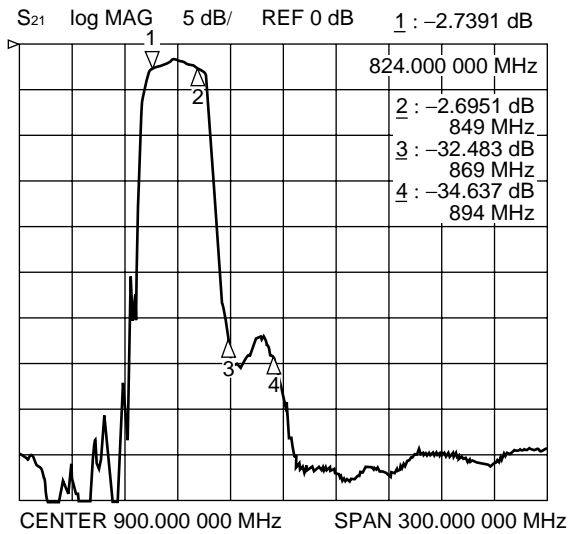

Filter 2 (Passband: 1850 to 1910 MHz)

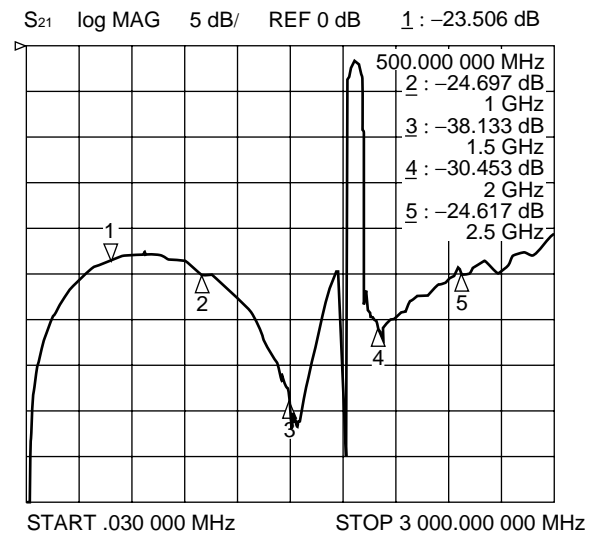
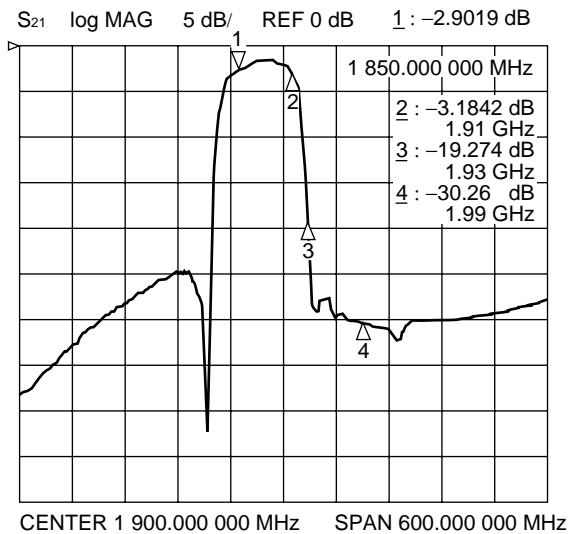

G5/G6 Series

4. AMPS (TDMA, CDMA) Rx + PCS Rx Part number: FAR-G6CH-1G9600-L215

Filter 1 (Passband: 869 to 894 MHz)

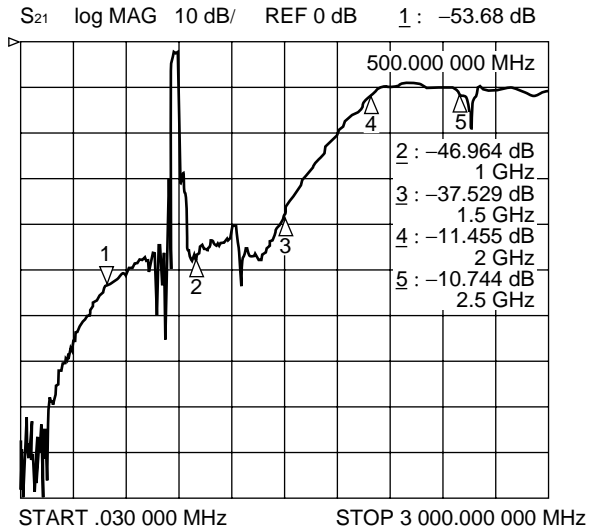
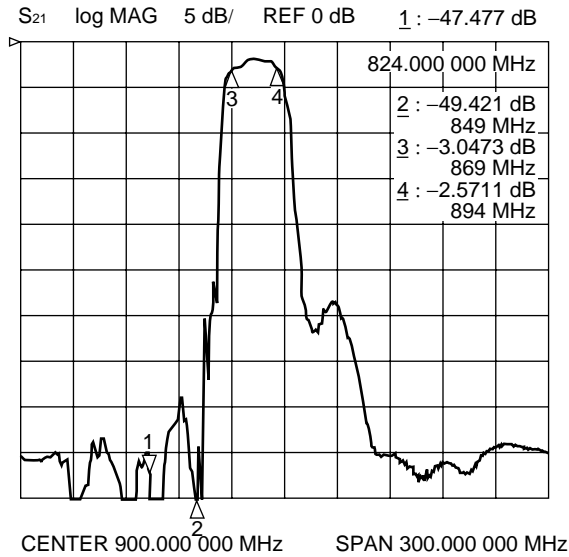

Filter 2 (Passband: 1930 to 1960 MHz)

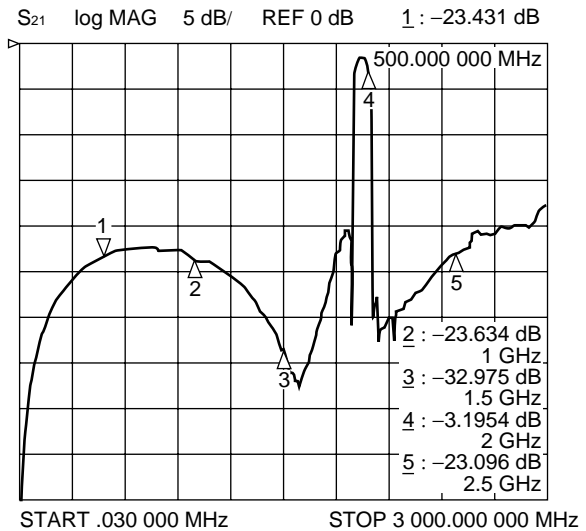
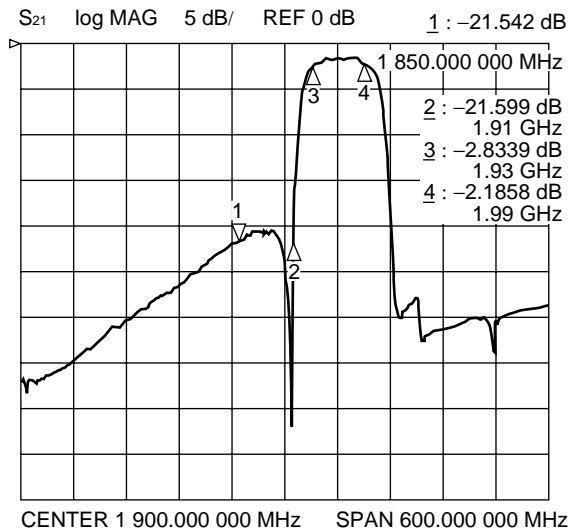

G5/G6 Series

5. GSM Tx + PCN Tx Part number: FAR-G6CH-1G7475-L216

Filter 1 (Passband: 890 to 915 MHz)

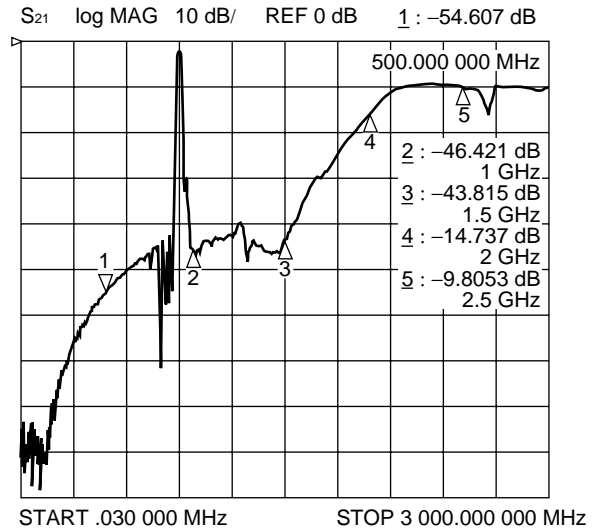
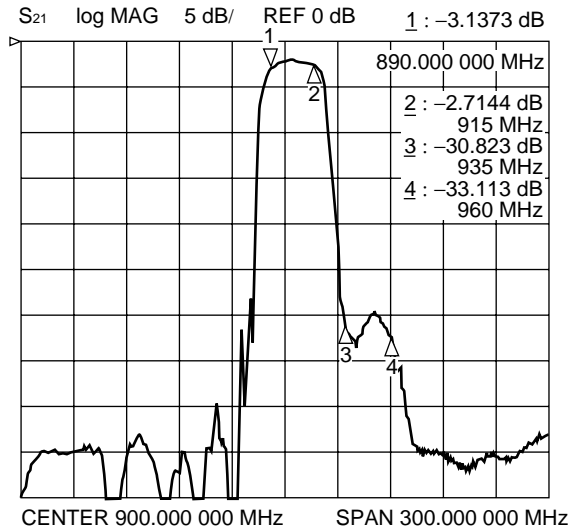

Filter 2 (Passband: 1710 to 1785 MHz)

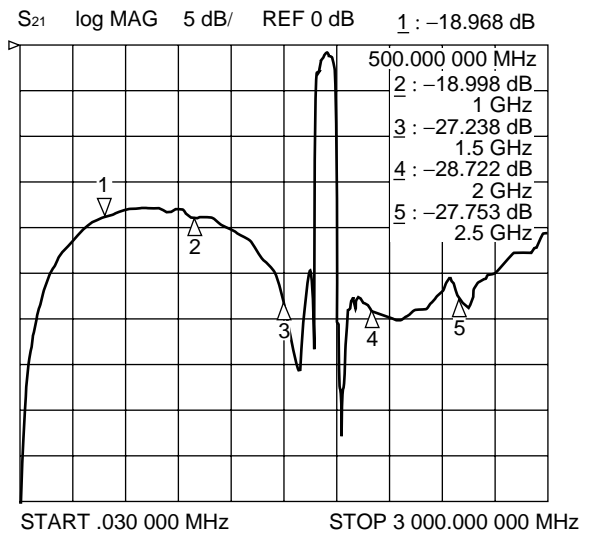
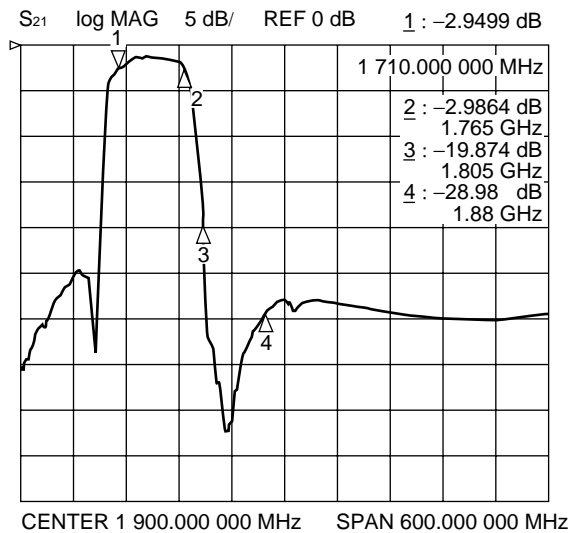

G5/G6 Series

6. GSM Rx + PCN Rx Part number: FAR-G6CH-1G8425-L217

Filter 1 (Passband: 935 to 960 MHz)

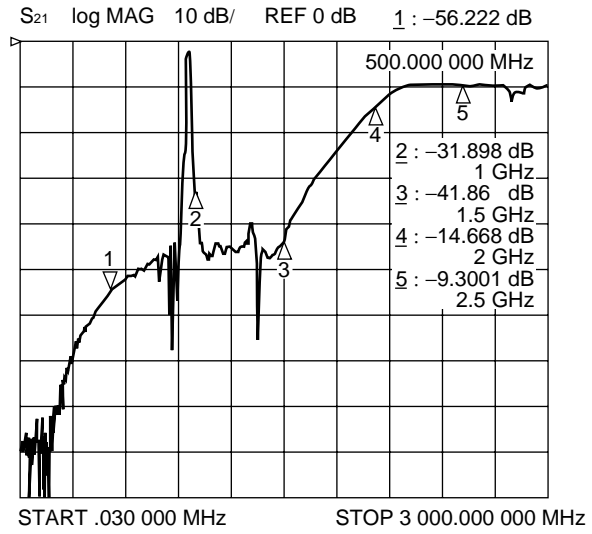
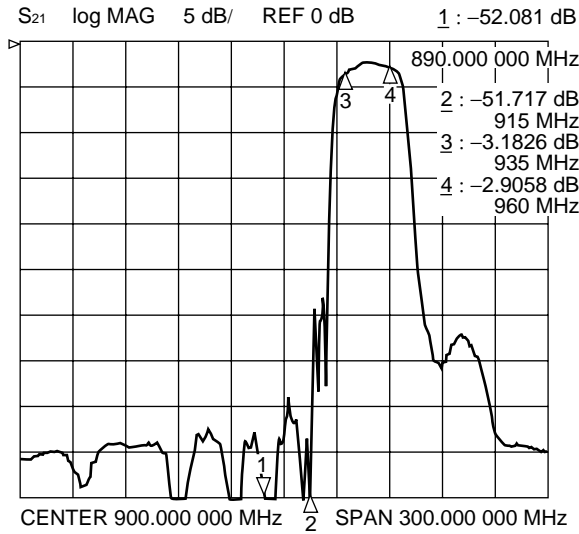

Filter 2 (Passband: 1805 to 1880 MHz)

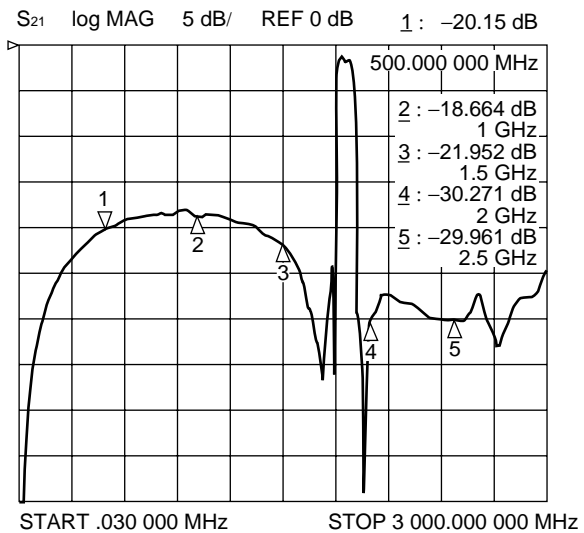
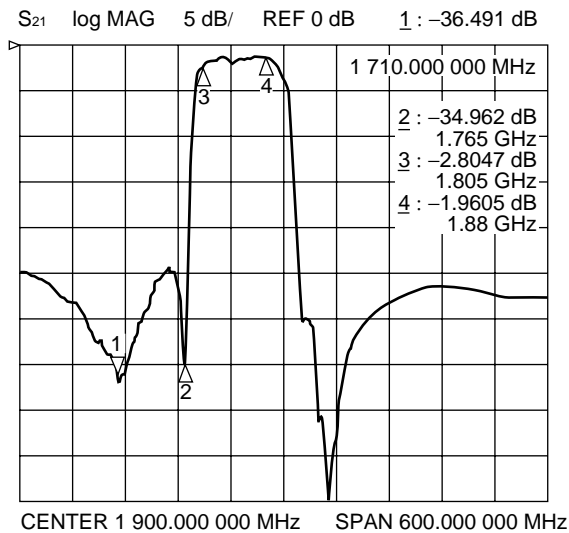

G5/G6 Series

7. EGSM Rx + PCN Rx Part number: FAR-G6CH-1G8425-L224

Filter 1 (Passband: 925 to 960 MHz)

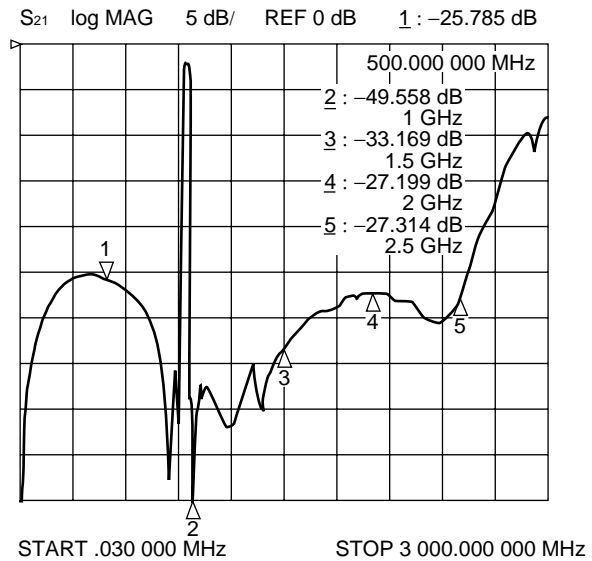
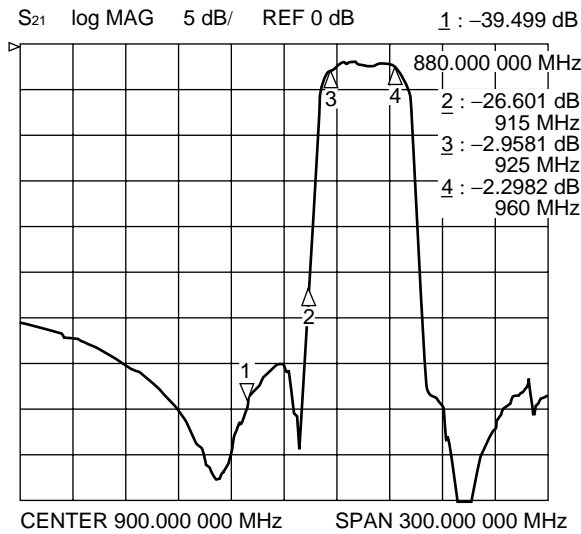

Filter 2 (Passband: 1805 to 1880 MHz)

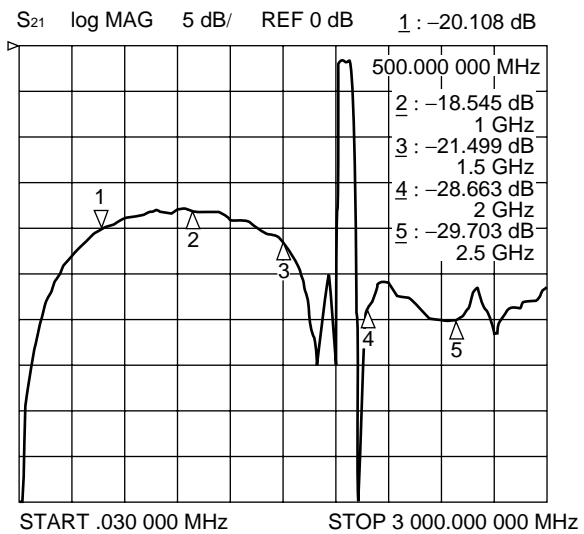
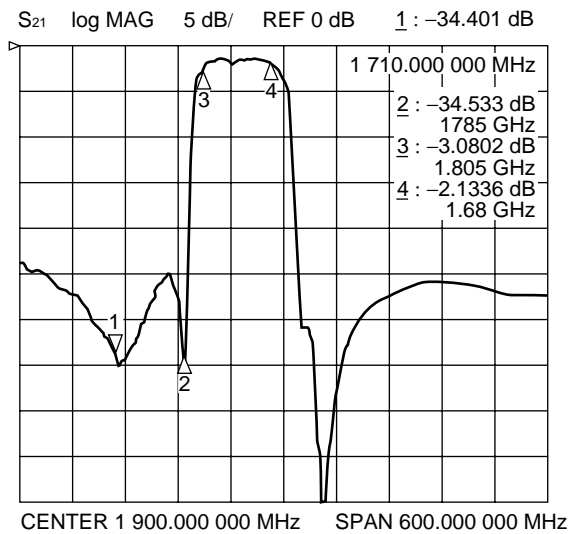

G5/G6 Series

8. PCN Rx + PCS Rx Part number: FAR-G6CH-1G9600-L219

Filter 1 (Passband: 1805 to 1880 MHz)

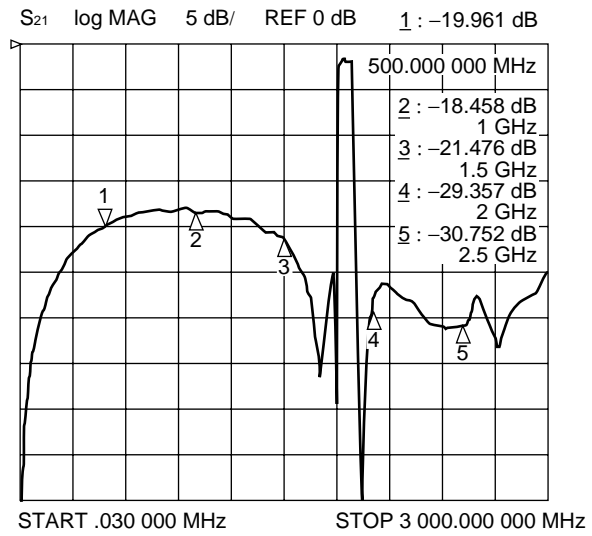
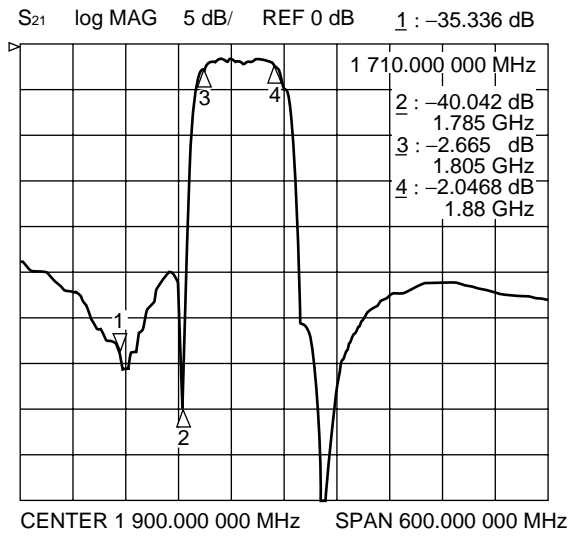

Filter 2 (Passband: 1930 to 1990 MHz)

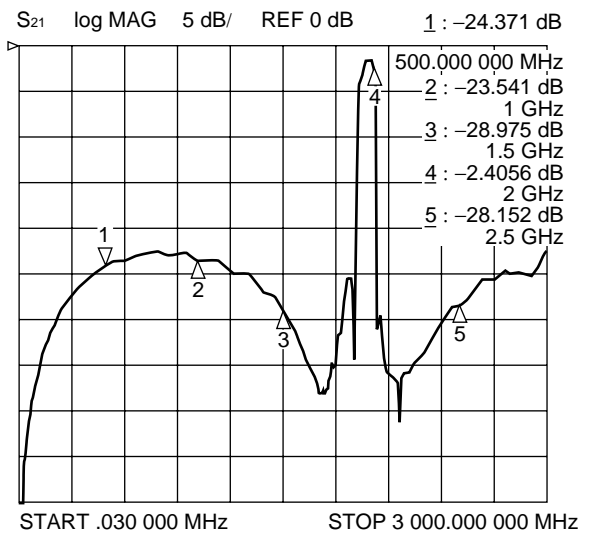
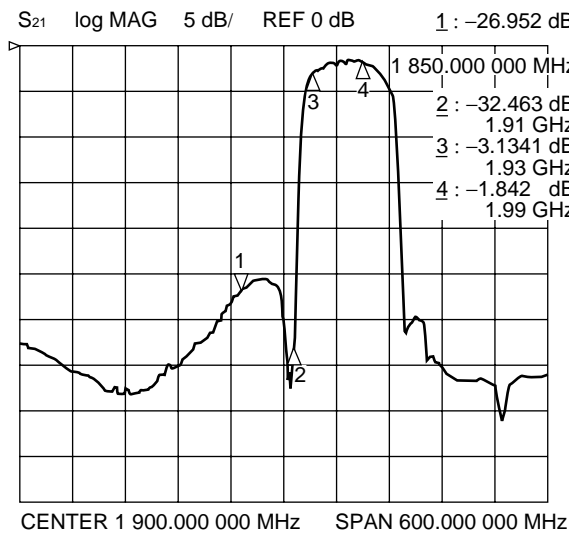

G5/G6 Series

9. PCS Tx split band (low band + high band dual) Part number: FAR-G6CH-1G8950-L210D

Filter 1 (Passband: 1850 to 1880 MHz)

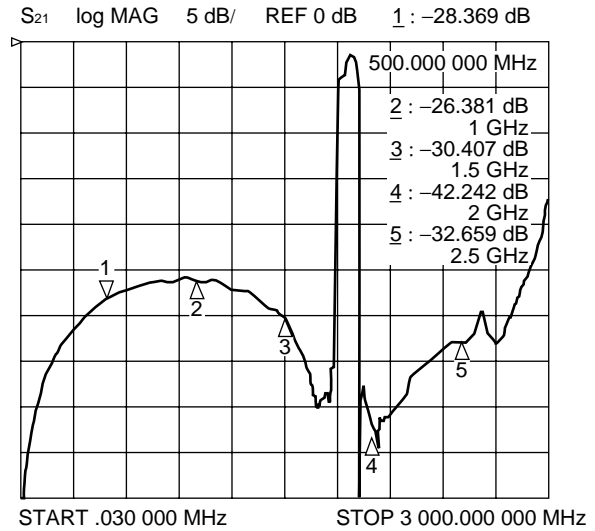
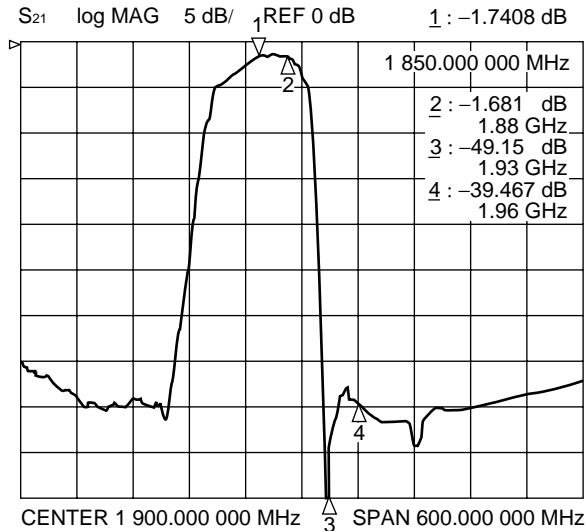

Filter 2 (Passband: 1880 to 1910 MHz)

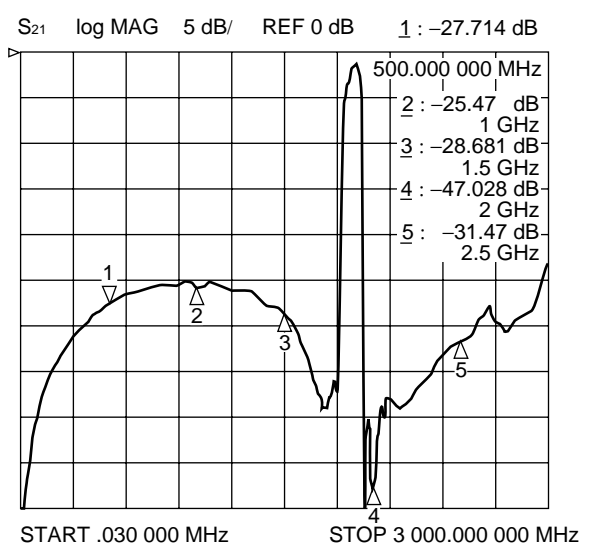
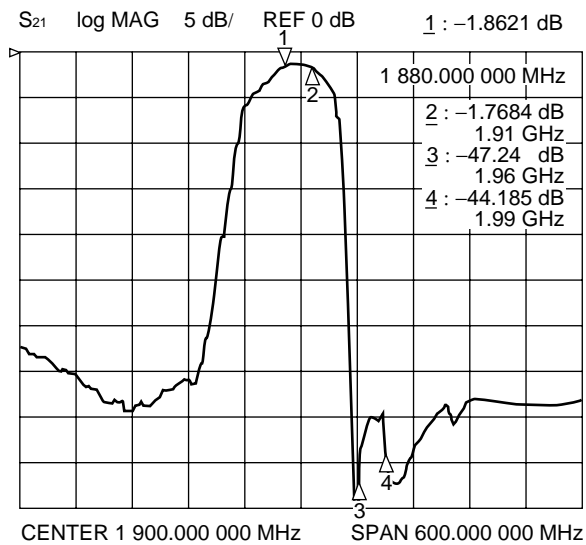

G5/G6 Series

10.PCS Rx split band (low band + high band dual) Part number: FAR-G6CH-1G9750-L230

Filter 1 (Passband: 1930 to 1960 MHz)

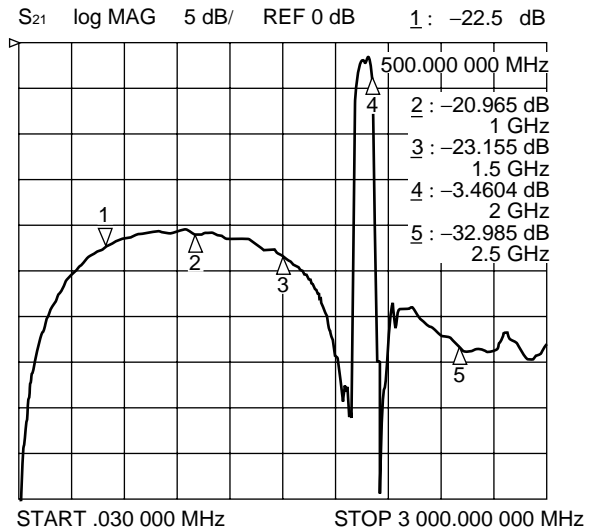
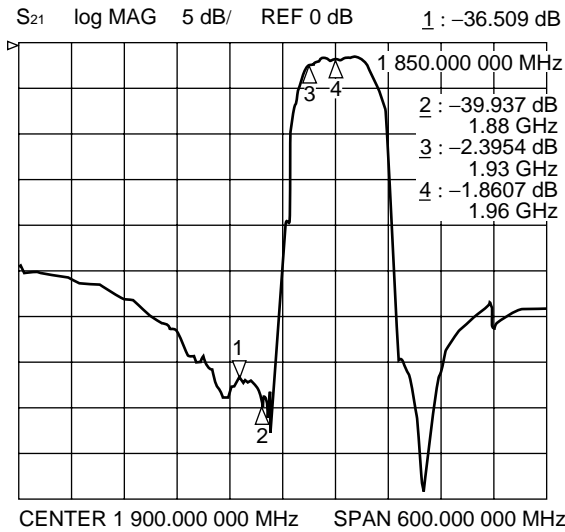

Filter 2 (Passband: 1960 to 1990 MHz)

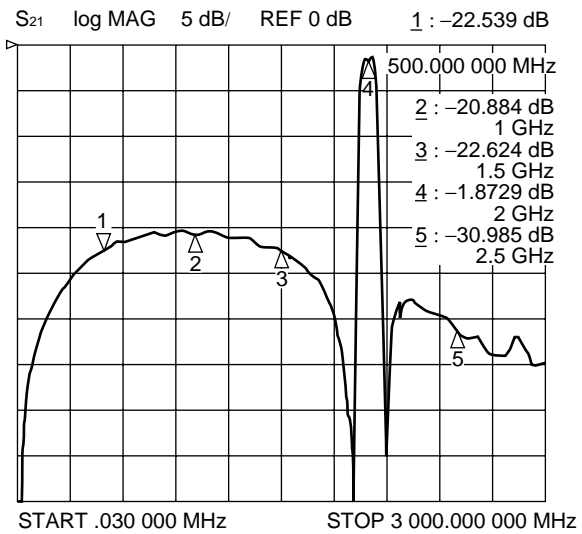
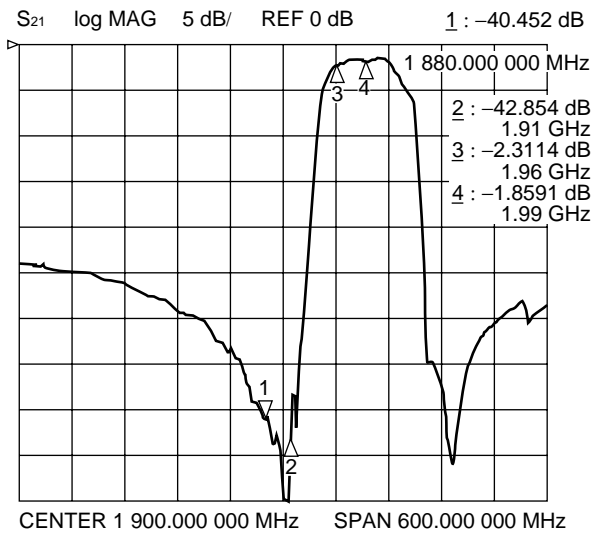

G5/G6 Series

MEASUREMENT CIRCUIT

1 in/2 out type (G5CN filters)

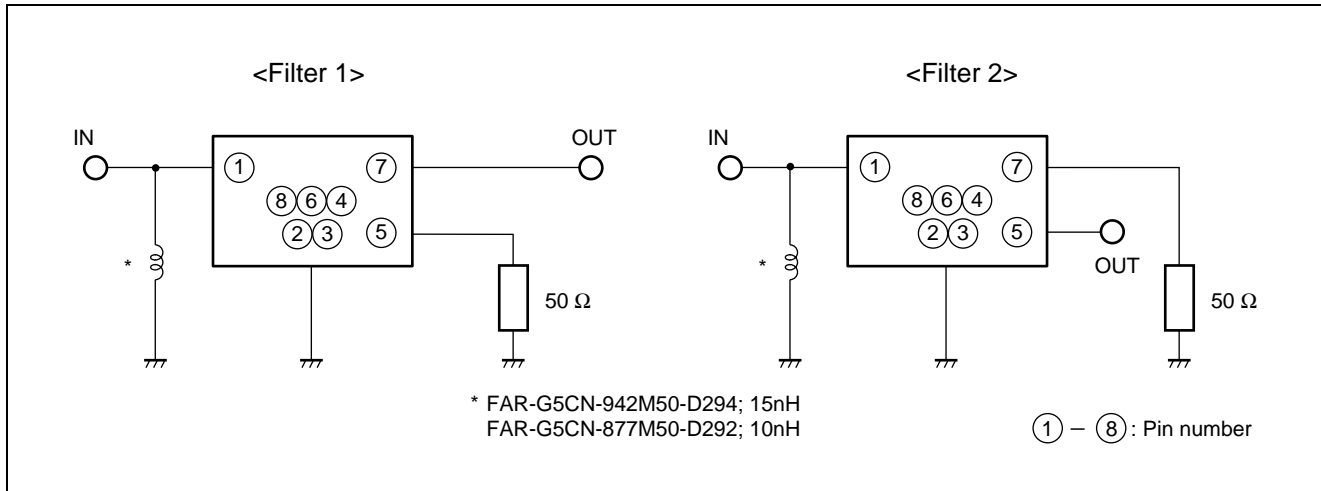

2 in/2 out type (G6CH filters)

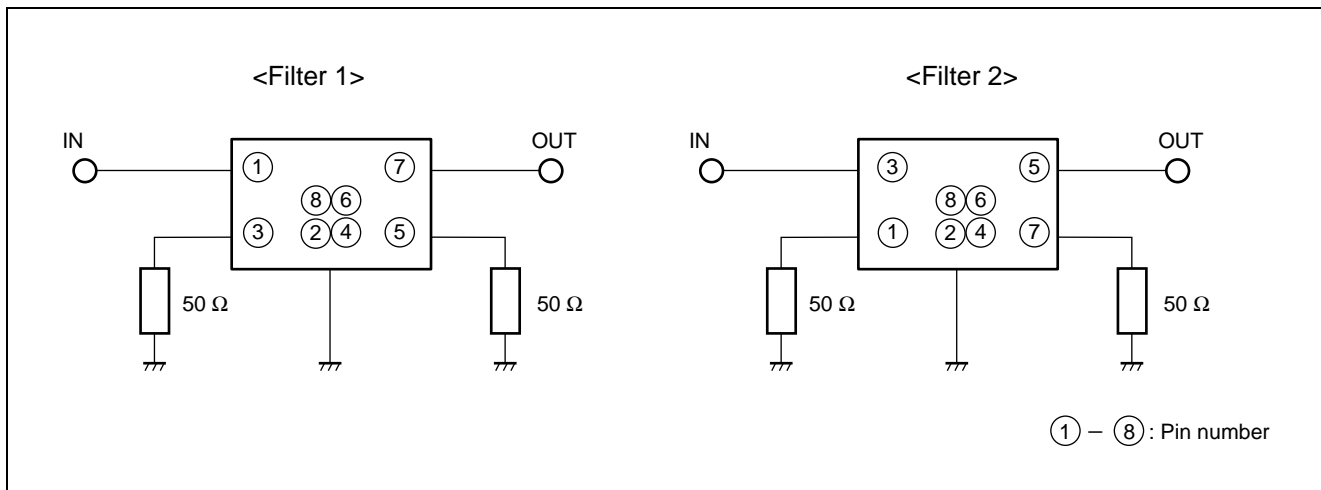

RECOMMENDED EXTERNAL CIRCUIT OF 1 IN/2 OUT TYPE

(G5CN filters)

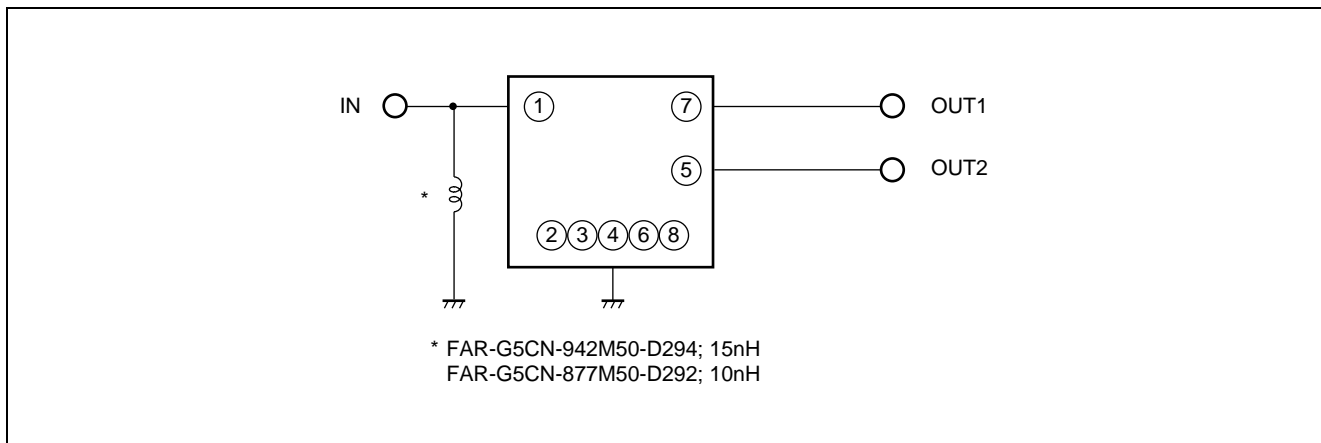

G5/G6 Series

MARKING

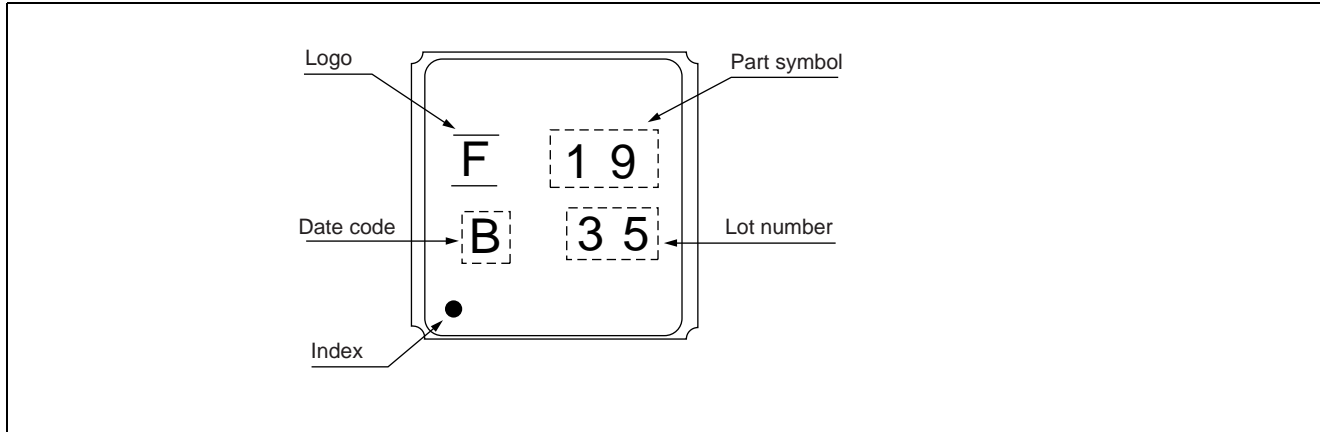

PART NUMBER DESIGNATION

[Designation example]

<G5CN FILTER>
 FAR-G5CN-□□□□□□-D2□□-□
 (1) (2) (3)

(1) Frequency: This specifies the nominal center frequency of higher frequency side using six alphanumeric.

M (for MHz) indicates the decimal point.

[Example] 877M50 ⇒ 877.5 MHz

(2) Part symbol: 01 to 99 (Numbers specified by Fujitsu)

(3) Packing: W ; 1 K pcs/reel

U ; 3 K pcs/reel

V ; 5 K pcs/reel

<G6CN FILTER>
 FAR-G6CH-□□□□□□-L2 □□-□
 (1) (2) (3)

(1) Frequency: This specifies the nominal center frequency of higher frequency side using six alphanumeric.

G (for GHz) indicates the decimal point.

[Example] 1G8800 ⇒ 1.88 GHz

(2) Part symbol: 01 to 99 (Numbers specified by Fujitsu)

(3) Packing: T ; 1 K pcs/reel

R ; 3 K pcs/reel

G5/G6 Series

■ DIMENSIONS

<G5CN Package>

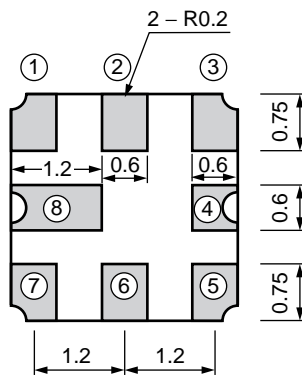
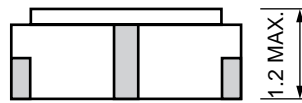
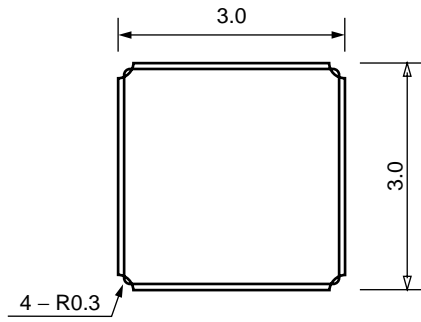

<G6CH Package>

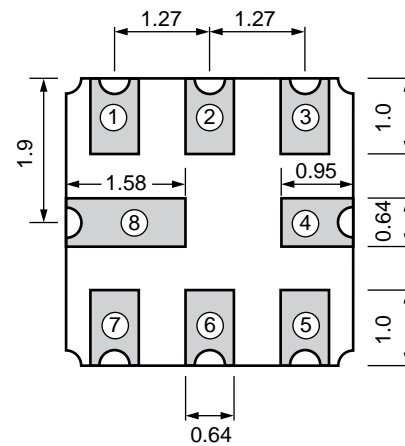
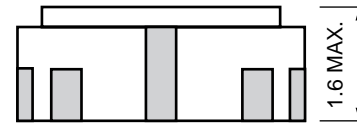
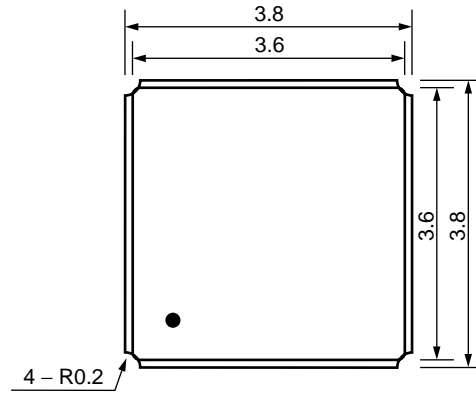

Dimensions in mm

G5/G6 Series

■ PACKING

1. Reel type

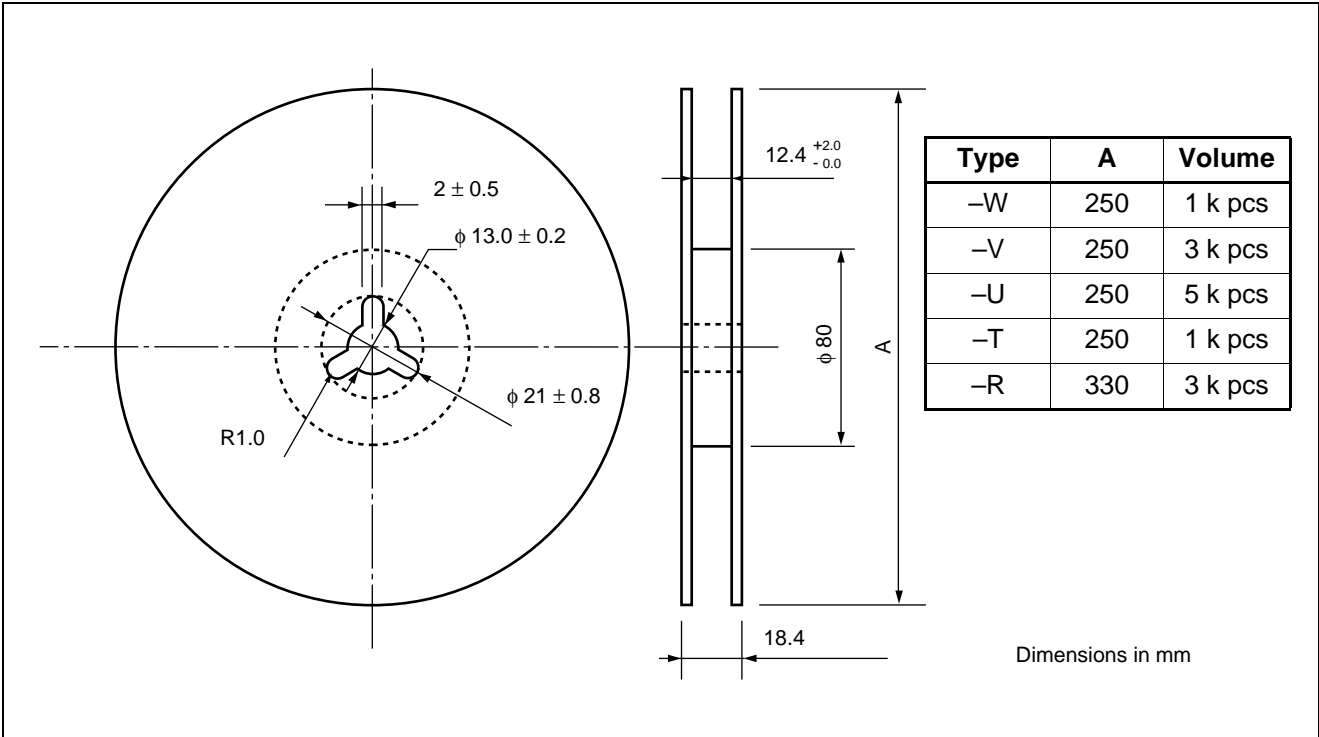

2. Packing Style

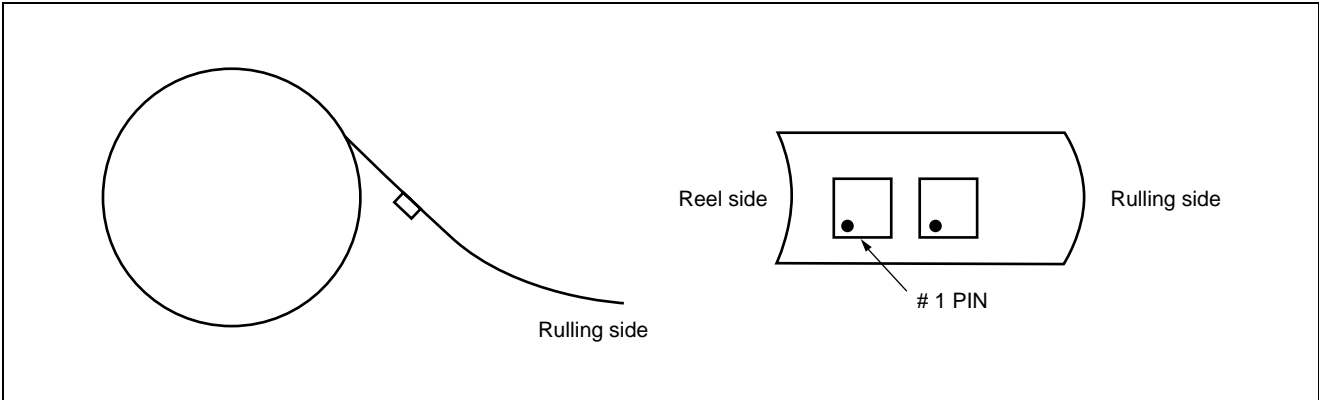

G5/G6 Series

3. Tape Dimensions

<G5CN filters>

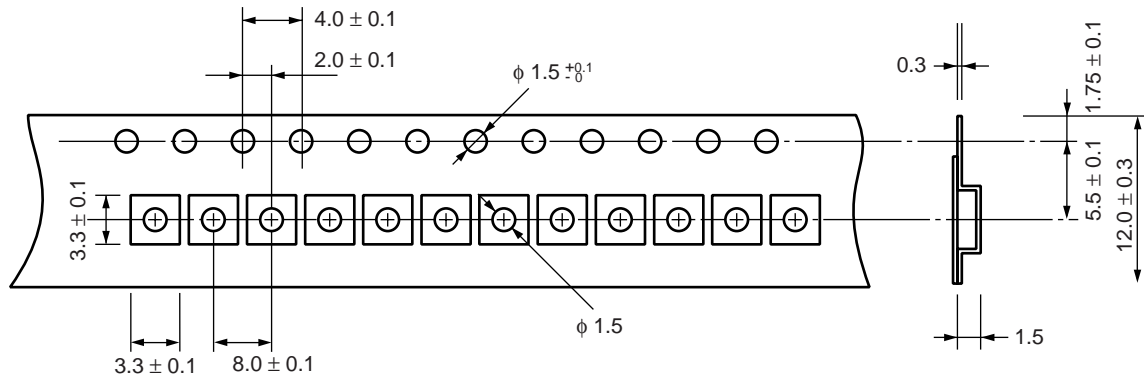

<G6CH filters>

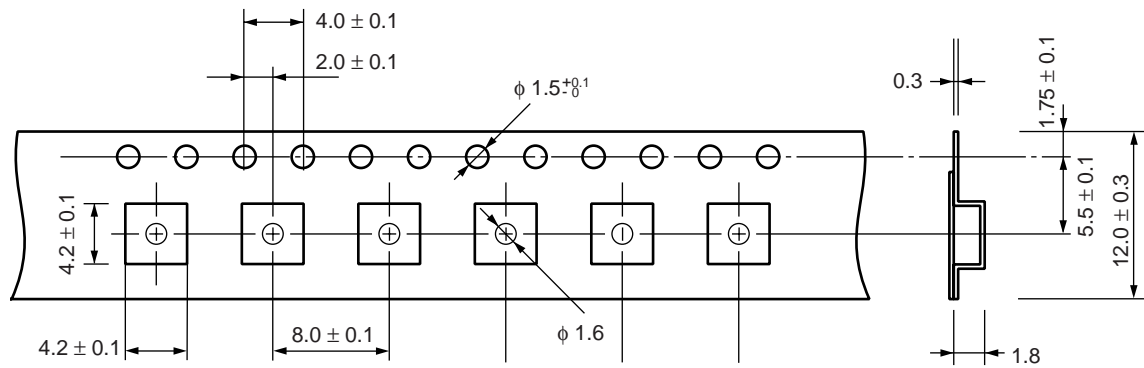

Dimensions in mm

G5/G6 Series

FUJITSU LIMITED

For further information please contact:

Japan

FUJITSU MEDIA DEVICES LIMITED
Marketing and Technical Support Dept.
SUN HAMADA BLDG 2F
1-19-20, Shin-yokohama
Kouhoku-ku, Yokohama-shi
Kanagawa 222-0033, Japan
Tel: 81(45) 471-0067
Fax: 81(45) 471-0069

<http://www.fujitsu.co.jp/>

North and South America

FUJITSU MICROELECTRONICS, INC.
Semiconductor Division
3545 North First Street
San Jose, CA 95134-1804, USA
Tel: (408) 922-9000
Fax: (408) 922-9179

Customer Response Center
Mon. - Fri.: 7 am - 5 pm (PST)
Tel: (800) 866-8608
Fax: (408) 922-9179

<http://www.fujitsumicro.com/>

Europe

FUJITSU MIKROELEKTRONIK GmbH
Am Siebenstein 6-10
D-63303 Dreieich-Buchsschlag
Germany
Tel: (06103) 690-0
Fax: (06103) 690-122

<http://www.fujitsu-edc.com/>

Asia Pacific

FUJITSU MICROELECTRONICS ASIA PTE LTD
#05-08, 151 Lorong Chuan
New Tech Park
Singapore 556741
Tel: (65) 281-0770
Fax: (65) 281-0220

<http://www.fmap.com.sg/>

F9812

© FUJITSU LIMITED Printed in Japan

All Rights Reserved.

The contents of this document are subject to change without notice. Customers are advised to consult with FUJITSU sales representatives before ordering.

The information and circuit diagrams in this document are presented as examples of semiconductor device applications, and are not intended to be incorporated in devices for actual use. Also, FUJITSU is unable to assume responsibility for infringement of any patent rights or other rights of third parties arising from the use of this information or circuit diagrams.

FUJITSU semiconductor devices are intended for use in standard applications (computers, office automation and other office equipment, industrial, communications, and measurement equipment, personal or household devices, etc.). CAUTION:

Customers considering the use of our products in special applications where failure or abnormal operation may directly affect human lives or cause physical injury or property damage, or where extremely high levels of reliability are demanded (such as aerospace systems, atomic energy controls, sea floor repeaters, vehicle operating controls, medical devices for life support, etc.) are requested to consult with FUJITSU sales representatives before such use. The company will not be responsible for damages arising from such use without prior approval.

Any semiconductor devices have an inherent chance of failure. You must protect against injury, damage or loss from such failures by incorporating safety design measures into your facility and equipment such as redundancy, fire protection, and prevention of over-current levels and other abnormal operating conditions.

If any products described in this document represent goods or technologies subject to certain restrictions on export under the Foreign Exchange and Foreign Trade Law of Japan, the prior authorization by Japanese government will be required for export of those products from Japan.