

Fast Recovery Epitaxial Diode (FRED) Module

MEA 300-06 DA
MEK 300-06 DA
MEE 300-06 DA

$V_{RRM} = 600\text{ V}$
 $I_{FAVM} = 304\text{ A}$
 $t_{rr} = 250\text{ ns}$

Preliminary data

V_{RSM} V	V_{RRM} V	Type	MEK 300-06DA	MEE 300-06DA
600	600			

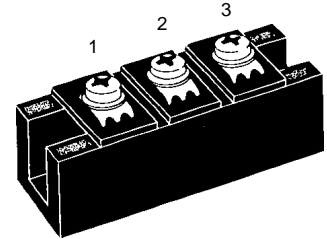

Symbol	Test Conditions	Maximum Ratings
I_{FRMS}	$T_C = 75\text{ °C}$	430 A
I_{FAVM} ①	$T_C = 75\text{ °C}$; rectangular, $d = 0.5$	304 A
I_{FRM}	$t_p < 10\text{ }\mu\text{s}$; rep. rating, pulse width limited by T_{VJM}	1640 A
I_{FSM}	$T_{VJ} = 45\text{ °C}$; $t = 10\text{ ms}$ (50 Hz), sine	2400 A
	$t = 8.3\text{ ms}$ (60 Hz), sine	2640 A
	$T_{VJ} = 150\text{ °C}$; $t = 10\text{ ms}$ (50 Hz), sine	2160 A
	$t = 8.3\text{ ms}$ (60 Hz), sine	2380 A
I^2t	$T_{VJ} = 45\text{ °C}$; $t = 10\text{ ms}$ (50 Hz), sine	28800 A ² s
	$t = 8.3\text{ ms}$ (60 Hz), sine	29300 A ² s
	$T_{VJ} = 150\text{ °C}$; $t = 10\text{ ms}$ (50 Hz), sine	23300 A ² s
	$t = 8.3\text{ ms}$ (60 Hz), sine	23800 A ² s
T_{VJ}		-40...+150 °C
T_{stg}		-40...+125 °C
T_{Smax}		110 °C
P_{tot}	$T_C = 25\text{ °C}$	875 W
V_{ISOL}	50/60 Hz, RMS $t = 1\text{ min}$	3000 V~
	$I_{ISOL} \leq 1\text{ mA}$ $t = 1\text{ s}$	3600 V~
M_d	Mounting torque (M6)	2.25-2.75/20-25 Nm/lb.in.
	Terminal connection torque (M6)	4.50-5.50/40-48 Nm/lb.in.
d_s	Creeping distance on surface	12.7 mm
d_A	Strike distance through air	9.6 mm
a	Maximum allowable acceleration	50 m/s ²
Weight		150 g

Features

- International standard package with DCB ceramic base plate
- Planar passivated chips
- Short recovery time
- Low switching losses
- Soft recovery behaviour
- Isolation voltage 3600 V~
- UL registered E 72873

Applications

- Antiparallel diode for high frequency switching devices
- Free wheeling diode in converters and motor control circuits
- Inductive heating and melting
- Uninterruptible power supplies (UPS)
- Ultrasonic cleaners and welders

Advantages

- High reliability circuit operation
- Low voltage peaks for reduced protection circuits
- Low noise switching
- Low losses

Dimensions in mm (1 mm = 0.0394")

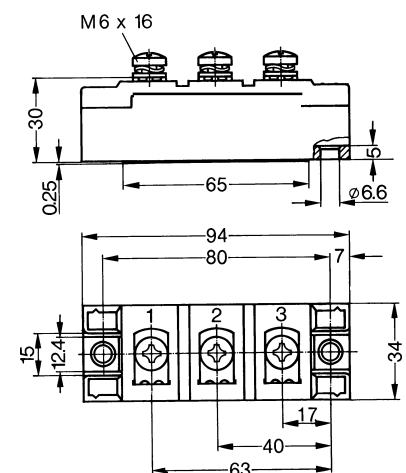

① I_{FAVM} rating includes reverse blocking losses at T_{VJM} , $V_R = 0.6 V_{RRM}$, duty cycle $d = 0.5$

Data according to IEC 60747

IXYS reserves the right to change limits, test conditions and dimensions

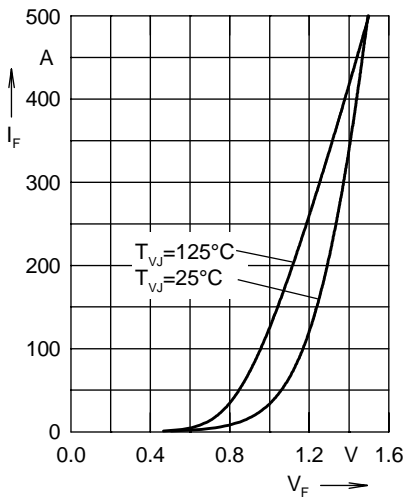

Fig. 1 Forward current I_F versus max. voltage drop V_F per leg

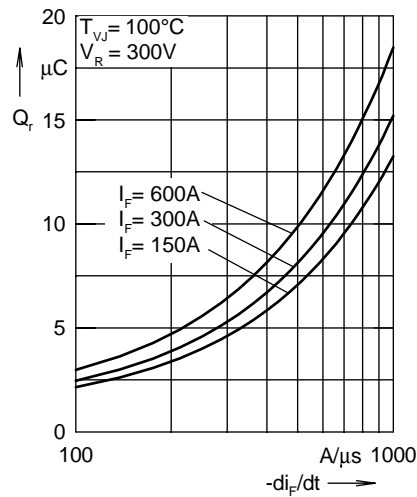

Fig. 2 Typ. reverse recovery charge Q_r versus $-di_F/dt$

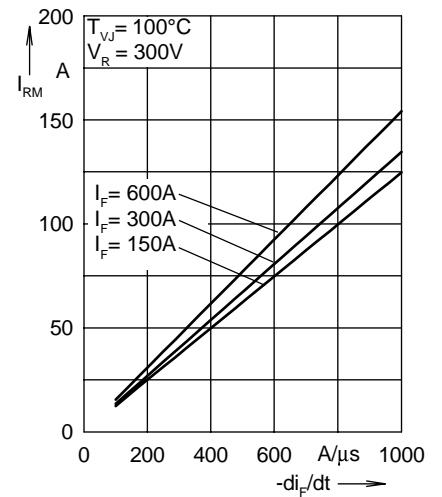

Fig. 3 Typ. peak reverse current I_{RM} versus $-di_F/dt$

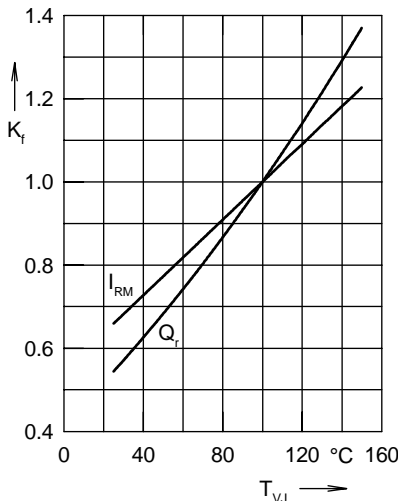

Fig. 4 Dynamic parameters Q_r , I_{RM} versus junction temperature T_{VJ}

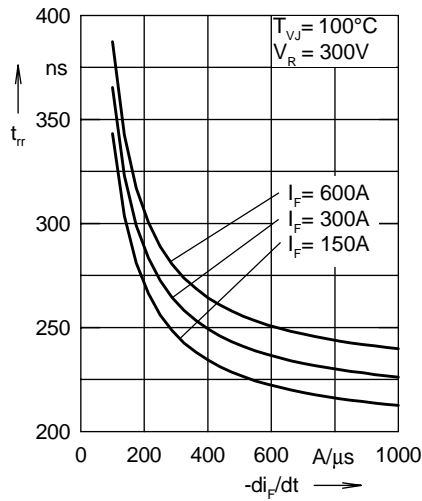

Fig. 5 Typ. recovery time t_{tr} versus $-di_F/dt$

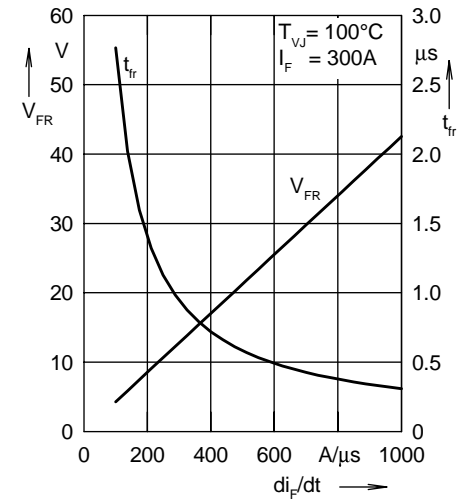

Fig. 6 Typ. peak forward voltage V_{FR} and t_{tr} versus di_F/dt

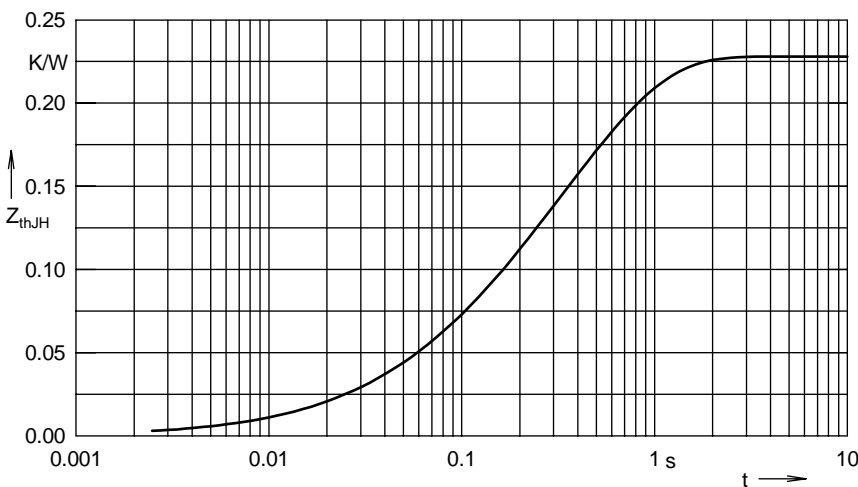

Fig. 7 Transient thermal impedance junction to heatsink

Constants for Z_{thJS} calculation:

i	R_{thi} (K/W)	t_i (s)
1	0.002	0.08
2	0.008	0.024
3	0.054	0.112
4	0.164	0.464