

TENTATIVE TOSHIBA MOS DIGITAL INTEGRATED CIRCUIT SILICON GATE CMOS

1,048,576-WORD BY 16-BIT/2,097,152-WORD BY 8-BIT FULL CMOS STATIC RAM

DESCRIPTION

The TC55VBM416AFTN is a 16,777,216-bit static random access memory (SRAM) organized as 1,048,576 words by 16 bits/2,097,152 words by 8 bits. Fabricated using Toshiba's CMOS Silicon gate process technology, this device operates from a single 2.3 to 3.6 V power supply. Advanced circuit technology provides both high speed and low power at an operating current of 3 mA/MHz and a minimum cycle time of 55 ns. It is automatically placed in low-power mode at 0.9 μ A standby current (at $V_{DD} = 3$ V, $T_a = 25^\circ\text{C}$, typical) when chip enable ($\overline{CE1}$) is asserted high or ($\overline{CE2}$) is asserted low. There are three control inputs. $\overline{CE1}$ and $\overline{CE2}$ are used to select the device and for data retention control, and output enable (\overline{OE}) provides fast memory access. Data byte control pin (\overline{LB} , \overline{UB}) provides lower and upper byte access. This device is well suited to various microprocessor system applications where high speed, low power and battery backup are required. And, with a guaranteed operating extreme temperature range of -40° to 85°C , the TC55VBM416AFTN can be used in environments exhibiting extreme temperature conditions. The TC55VBM416AFTN is available in a plastic 48-pin thin-small-outline package (TSOP).

FEATURES

- Low-power dissipation
Operating: 9 mW/MHz (typical)
- Single power supply voltage of 2.3 to 3.6 V
- Power down features using $\overline{CE1}$ and $\overline{CE2}$
- Data retention supply voltage of 1.5 to 3.6 V
- Direct TTL compatibility for all inputs and outputs
- Wide operating temperature range of -40° to 85°C
- Standby Current (maximum):

3.6 V	15 μ A
3.0 V	8 μ A

- Access Times (maximum):

Access Time	55 ns
$\overline{CE1}$ Access Time	55 ns
$\overline{CE2}$ Access Time	55 ns
\overline{OE} Access Time	30 ns

- Package:

TSOP 48-P-1220-0.50 (Weight:0.51 g typ)

PIN ASSIGNMENT (TOP VIEW)

48 PIN TSOP

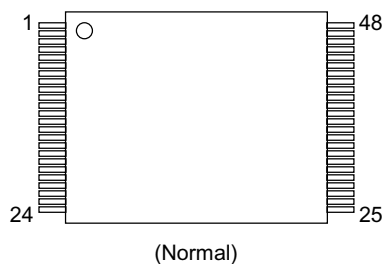

PIN NAMES

A0~A19	Address Inputs (Word Mode)
A-1~A19	Address Inputs (Byte Mode)
$\overline{CE1}$, $\overline{CE2}$	Chip Enable
R/W	Read/Write Control
\overline{OE}	Output Enable
\overline{LB} , \overline{UB}	Data Byte Control
I/O1~I/O16	Data Inputs/Outputs
\overline{BYTE}	Byte ($\times 8$ mode) Enable
V_{DD}	Power
GND	Ground
NC	No Connection
OP*	Option

*: OP pin must be open or connected to GND.

Pin No.	1	2	3	4	5	6	7	8	9	10	11	12	13	14	15	16
Pin Name	A15	A14	A13	A12	A11	A10	A9	A8	A19	NC	R/W	$\overline{CE2}$	OP	\overline{UB}	\overline{LB}	A18
Pin No.	17	18	19	20	21	22	23	24	25	26	27	28	29	30	31	32
Pin Name	A17	A7	A6	A5	A4	A3	A2	A1	A0	$\overline{CE1}$	GND	\overline{OE}	I/O1	I/O9	I/O2	I/O10
Pin No.	33	34	35	36	37	38	39	40	41	42	43	44	45	46	47	48
Pin Name	I/O3	I/O11	I/O4	I/O12	V_{DD}	I/O5	I/O13	I/O6	I/O14	I/O7	I/O15	I/O8	I/O16/A-1	GND	\overline{BYTE}	A16

BLOCK DIAGRAM

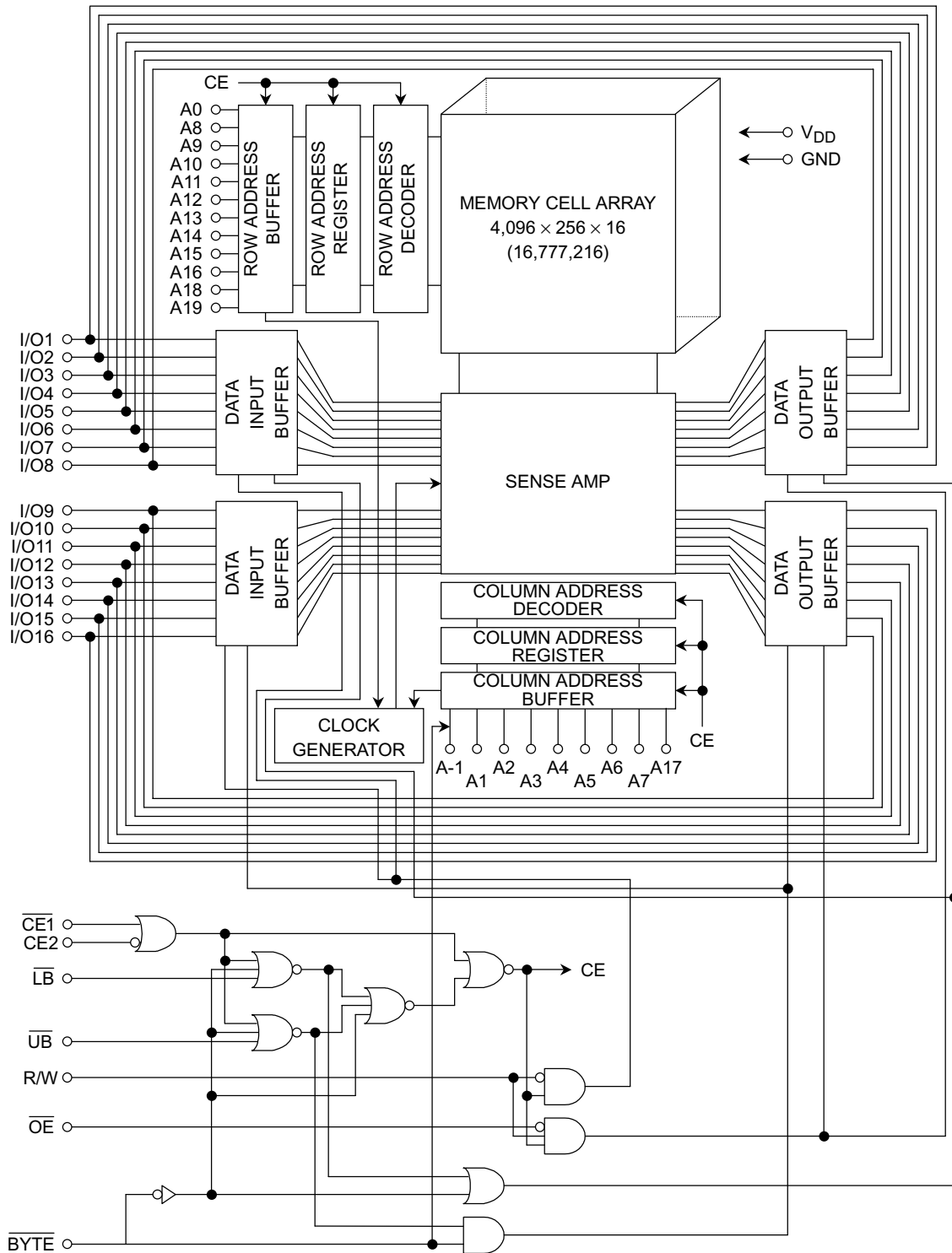

OPERATING MODE

MODE	$\overline{CE1}$	CE2	\overline{OE}	R/W	\overline{BYTE}	\overline{LB}	\overline{UB}	I/O1~I/O8	I/O9~I/O15	I/O16	POWER
Read	L	H	L	H	L	*	*	Output	High-Z	A-1	I _{DDO}
	L	H	L	H	H	L	L	Output	Output	Output	I _{DDO}
	L	H	L	H	H	H	L	High-Z	Output	Output	I _{DDO}
	L	H	L	H	H	L	H	Output	High-Z	High-Z	I _{DDO}
Write	L	H	*	L	L	*	*	Input	High-Z	A-1	I _{DDO}
	L	H	*	L	H	L	L	Input	Input	Input	I _{DDO}
	L	H	*	L	H	H	L	High-Z	Input	Input	I _{DDO}
	L	H	*	L	H	L	H	Input	High-Z	High-Z	I _{DDO}
Output Deselect	L	H	H	H	L	*	*	High-Z	High-Z	A-1	I _{DDO}
	L	H	H	H	H	L	L	High-Z	High-Z	High-Z	I _{DDO}
	L	H	H	H	H	H	L	High-Z	High-Z	High-Z	I _{DDO}
	L	H	H	H	H	L	H	High-Z	High-Z	High-Z	I _{DDO}
Standby	H	*	*	*	H or L	*	*	High-Z	High-Z	High-Z	I _{DDS}
	*	L	*	*	H or L	*	*	High-Z	High-Z	High-Z	I _{DDS}
	*	*	*	*	H	H	H	High-Z	High-Z	High-Z	I _{DDS}

* = don't care
H = logic high
L = logic low

MAXIMUM RATINGS

SYMBOL	RATING	VALUE	UNIT
V _{DD}	Power Supply Voltage	-0.3~4.2	V
V _{IN}	Input Voltage	-0.3*~4.2	V
V _{I/O}	Input/Output Voltage	-0.5~V _{DD} + 0.5	V
P _D	Power Dissipation	0.6	W
T _{solder}	Soldering Temperature (10s)	260	°C
T _{stg}	Storage Temperature	-55~150	°C
T _{opr}	Operating Temperature	-40~85	°C

*: -2.0 V when measured at a pulse width of 20ns

DC RECOMMENDED OPERATING CONDITIONS (Ta = -40° to 85°C)

SYMBOL	PARAMETER	MIN	TYP	MAX	UNIT	
V _{DD}	Power Supply Voltage	2.3	—	3.6	V	
V _{IH}	Input High Voltage	V _{DD} = 2.3 V~2.7 V	2.0	—	V _{DD} + 0.3	V
		V _{DD} = 2.7 V~3.6 V	2.2			
V _{IL}	Input Low Voltage	-0.3*	—	V _{DD} × 0.24	V	
V _{DH}	Data Retention Supply Voltage	1.5	—	3.6	V	

*: -2.0 V when measured at a pulse width of 20ns

DC CHARACTERISTICS (Ta = -40° to 85°C, VDD = 2.3 to 3.6 V)

SYMBOL	PARAMETER	TEST CONDITION		MIN	TYP	MAX	UNIT		
I _{IL}	Input Leakage Current	V _{IN} = 0 V~V _{DD}		—	—	±1.0	μA		
I _{OH}	Output High Current	V _{OH} = V _{DD} - 0.5 V		-0.5	—	—	mA		
I _{OL}	Output Low Current	V _{OL} = 0.4 V		2.1	—	—	mA		
I _{LO}	Output Leakage Current	CE1 = V _{IH} or CE2 = V _{IL} or LB = UB = V _{IH} or R/W = V _{IL} or OE = V _{IH} , V _{OUT} = 0 V~V _{DD}		—	—	±1.0	μA		
I _{DDO1}	Operating Current	CE1 = V _{IL} and CE2 = V _{IH} and R/W = V _{IH} , LB = UB = V _{IL} , I _{OUT} = 0 mA, Other Input = V _{IH} /V _{IL}	t _{cycle}	MIN	—	—	35	mA	
				1 μs	—	—	8		
I _{DDO2}	Operating Current	CE1 = 0.2 V and CE2 = V _{DD} - 0.2 V and R/W = V _{DD} - 0.2 V, LB = UB = 0.2 V, I _{OUT} = 0 mA, Other Input = V _{DD} - 0.2 V/0.2 V	t _{cycle}	MIN	—	—	30	mA	
				1 μs	—	—	3		
I _{DDS1}	Standby Current	1) CE1 = V _{IH} or CE2 = V _{IL} (at BYTE ≥ V _{DD} - 0.2 V or ≤ 0.2 V) 2) LB = UB = V _{IH} (at BYTE ≥ V _{DD} - 0.2 V)		—	—	1	mA		
I _{DDS2}		Standby Current	1) CE1 = V _{DD} - 0.2 V, CE2 = V _{DD} - 0.2 V (at BYTE ≥ V _{DD} - 0.2 V or ≤ 0.2 V) 2) CE2 = 0.2 V (at BYTE ≥ V _{DD} - 0.2 V or ≤ 0.2 V) 3) LB = UB = V _{DD} - 0.2 V, CE1 = 0.2 V, CE2 = V _{DD} - 0.2 V (at BYTE ≥ V _{DD} - 0.2 V)	V _{DD} = 3.3 V ± 0.3 V	Ta = -40~85°C	—	—	15	μA
				V _{DD} = 3.0 V	Ta = 25°C	—	0.9	—	
					Ta = -40~40°C	—	—	3	
	Ta = -40~85°C				—	—	8		

CAPACITANCE (Ta = 25°C, f = 1 MHz)

SYMBOL	PARAMETER	TEST CONDITION	MAX	UNIT
C _{IN}	Input Capacitance	V _{IN} = GND	10	pF
C _{OUT}	Output Capacitance	V _{OUT} = GND	10	pF

Note: This parameter is periodically sampled and is not 100% tested.

AC CHARACTERISTICS AND OPERATING CONDITIONS

($T_a = -40^\circ$ to 85°C , $V_{DD} = 2.7$ to 3.6 V)

READ CYCLE

SYMBOL	PARAMETER	MIN	MAX	UNIT
t_{RC}	Read Cycle Time	55	—	ns
t_{ACC}	Address Access Time	—	55	
t_{CO1}	Chip Enable($\overline{CE1}$) Access Time	—	55	
t_{CO2}	Chip Enable(CE2) Access Time	—	55	
t_{OE}	Output Enable Access Time	—	30	
t_{BA}	Data Byte Control Access Time	—	55	
t_{COE}	Chip Enable Low to Output Active	5	—	
t_{OEE}	Output Enable Low to Output Active	0	—	
t_{BE}	Data Byte Control Low to Output Active	5	—	
t_{OD}	Chip Enable High to Output High-Z	—	25	
t_{ODO}	Output Enable High to Output High-Z	—	25	
t_{BD}	Data Byte Control High to Output High-Z	—	25	
t_{OH}	Output Data Hold Time	10	—	

WRITE CYCLE

SYMBOL	PARAMETER	MIN	MAX	UNIT
t_{WC}	Write Cycle Time	55	—	ns
t_{WP}	Write Pulse Width	40	—	
t_{CW}	Chip Enable to End of Write	45	—	
t_{BW}	Data Byte Control to End of Write	45	—	
t_{AS}	Address Setup Time	0	—	
t_{WR}	Write Recovery Time	0	—	
t_{ODW}	R/W Low to Output High-Z	—	25	
t_{OEW}	R/W High to Output Active	0	—	
t_{DS}	Data Setup Time	25	—	
t_{DH}	Data Hold Time	0	—	

Note: t_{OD} , t_{ODO} , t_{BD} and t_{ODW} are specified in time when an output becomes high impedance, and are not judged depending on an output voltage level.

AC CHARACTERISTICS AND OPERATING CONDITIONS

($T_a = -40^\circ$ to 85°C , $V_{DD} = 2.3$ to 3.6 V)

READ CYCLE

SYMBOL	PARAMETER	MIN	MAX	UNIT
t_{RC}	Read Cycle Time	70	—	ns
t_{ACC}	Address Access Time	—	70	
t_{CO1}	Chip Enable($\overline{CE1}$) Access Time	—	70	
t_{CO2}	Chip Enable(CE2) Access Time	—	70	
t_{OE}	Output Enable Access Time	—	35	
t_{BA}	Data Byte Control Access Time	—	70	
t_{COE}	Chip Enable Low to Output Active	5	—	
t_{OEE}	Output Enable Low to Output Active	0	—	
t_{BE}	Data Byte Control Low to Output Active	5	—	
t_{OD}	Chip Enable High to Output High-Z	—	30	
t_{ODO}	Output Enable High to Output High-Z	—	30	
t_{BD}	Data Byte Control High to Output High-Z	—	30	
t_{OH}	Output Data Hold Time	10	—	

WRITE CYCLE

SYMBOL	PARAMETER	MIN	MAX	UNIT
t_{WC}	Write Cycle Time	70	—	ns
t_{WP}	Write Pulse Width	50	—	
t_{CW}	Chip Enable to End of Write	55	—	
t_{BW}	Data Byte Control to End of Write	55	—	
t_{AS}	Address Setup Time	0	—	
t_{WR}	Write Recovery Time	0	—	
t_{ODW}	R/W Low to Output High-Z	—	30	
t_{OEW}	R/W High to Output Active	0	—	
t_{DS}	Data Setup Time	30	—	
t_{DH}	Data Hold Time	0	—	

Note: t_{OD} , t_{ODO} , t_{BD} and t_{ODW} are specified in time when an output becomes high impedance, and are not judged depending on an output voltage level.

AC TEST CONDITIONS

PARAMETER	TEST CONDITION
Input pulse level	0.2 V, $V_{DD} \times 0.7 V + 0.2 V$
t_R, t_F	1V / ns(Fig.1)
Timing measurements	$V_{DD} \times 0.5$
Reference level	$V_{DD} \times 0.5$
Output load	30 pF + 1 TTL Gate(Fig.2)

Fig.1 : Input rise and fall time

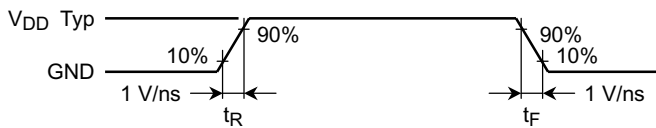
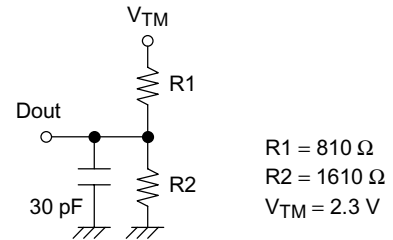

Fig.2 : Output load



BYTE FUNCTION

SYMBOL	PARAMETER	MIN	MAX	UNIT
t_{BS}	\overline{BYTE} Setup Time	5	—	ms
t_{BR}	\overline{BYTE} Recovery Time	5	—	ms

TIMING DIAGRAMS

\overline{BYTE}

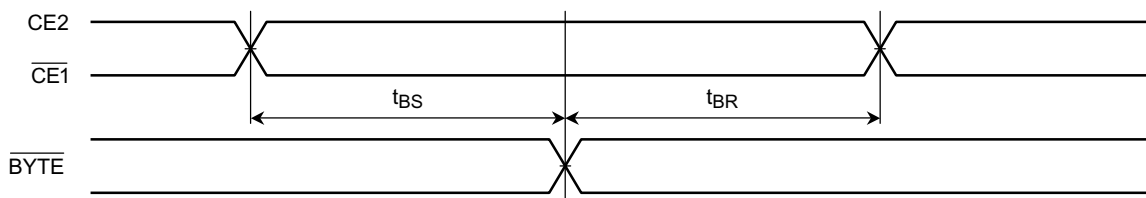

READ CYCLE (See Note 1)

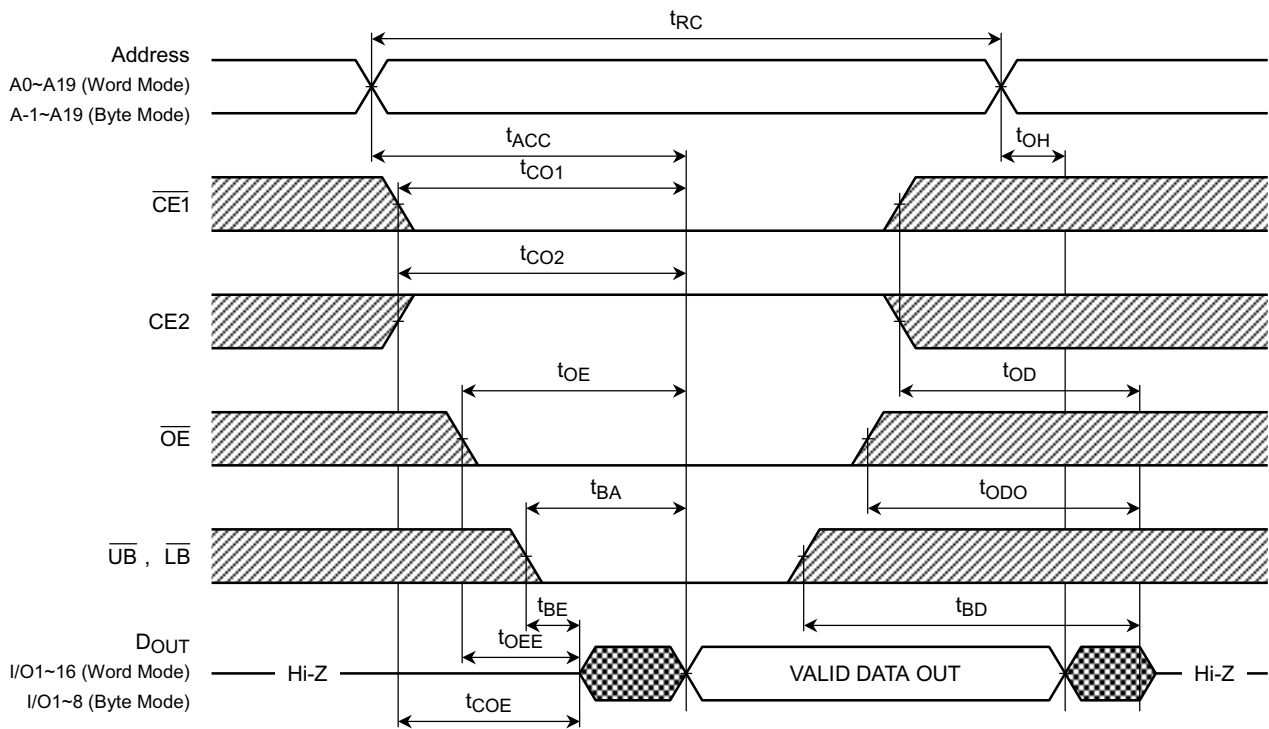

WRITE CYCLE 1 (R/W CONTROLLED) (See Note 4)

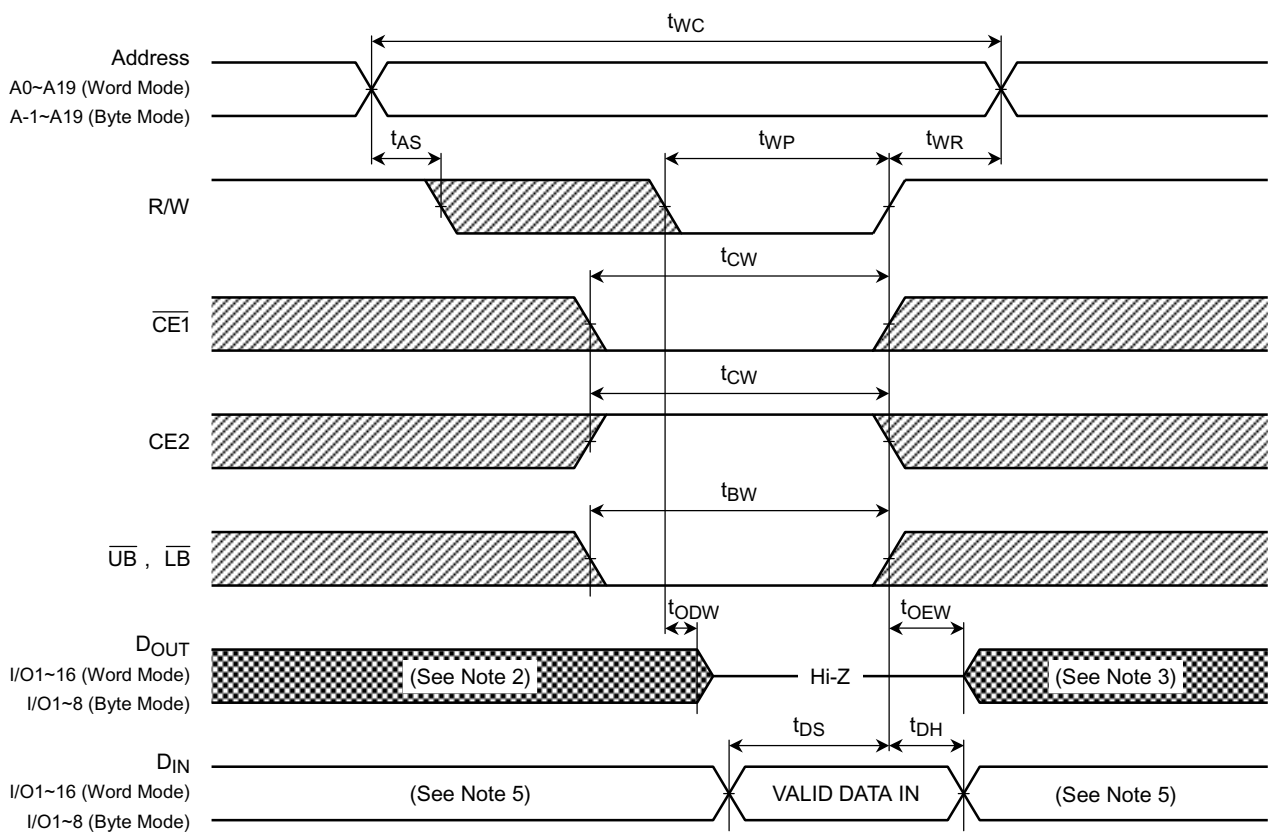

WRITE CYCLE 2 ($\overline{CE1}$ CONTROLLED) (See Note 4)

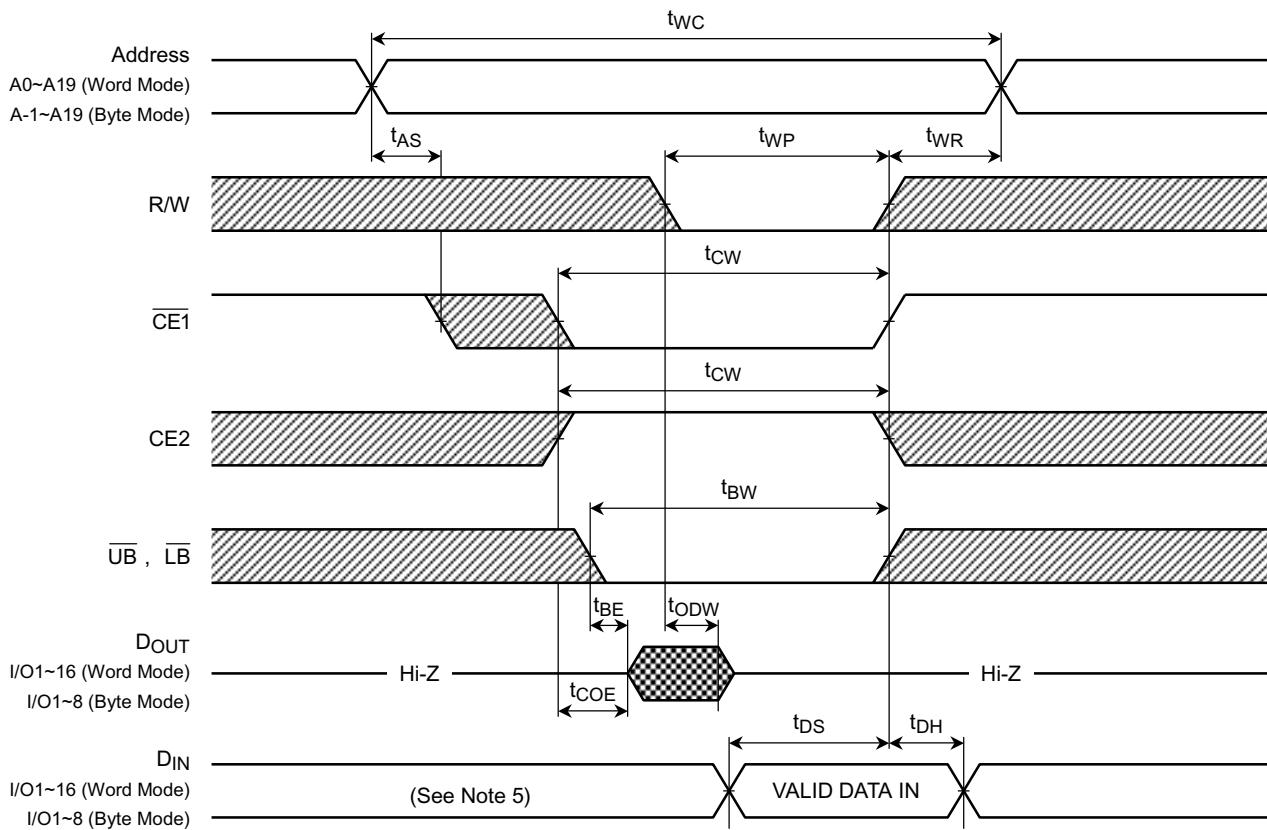

WRITE CYCLE 3 ($\overline{CE2}$ CONTROLLED) (See Note 4)

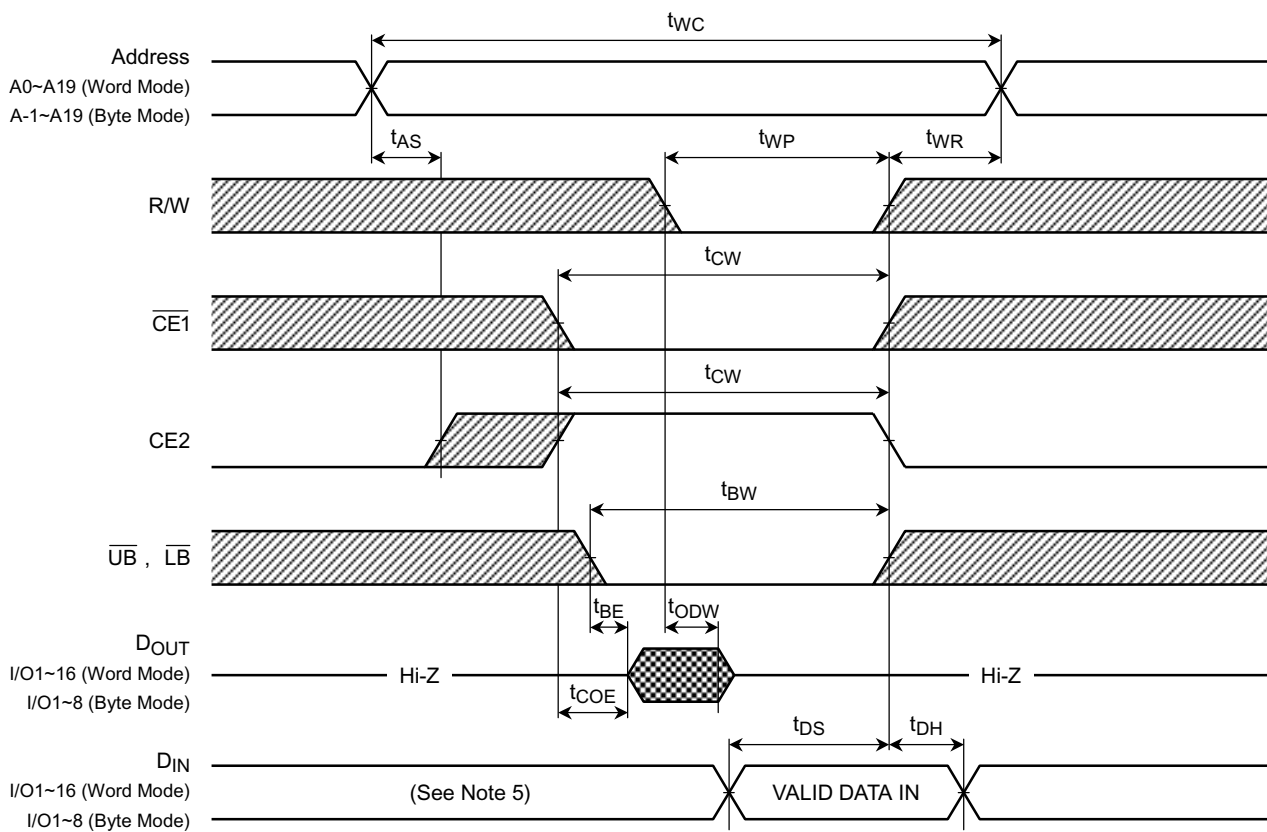

WRITE CYCLE 4 (\overline{UB} , \overline{LB} CONTROLLED) (See Note 4)

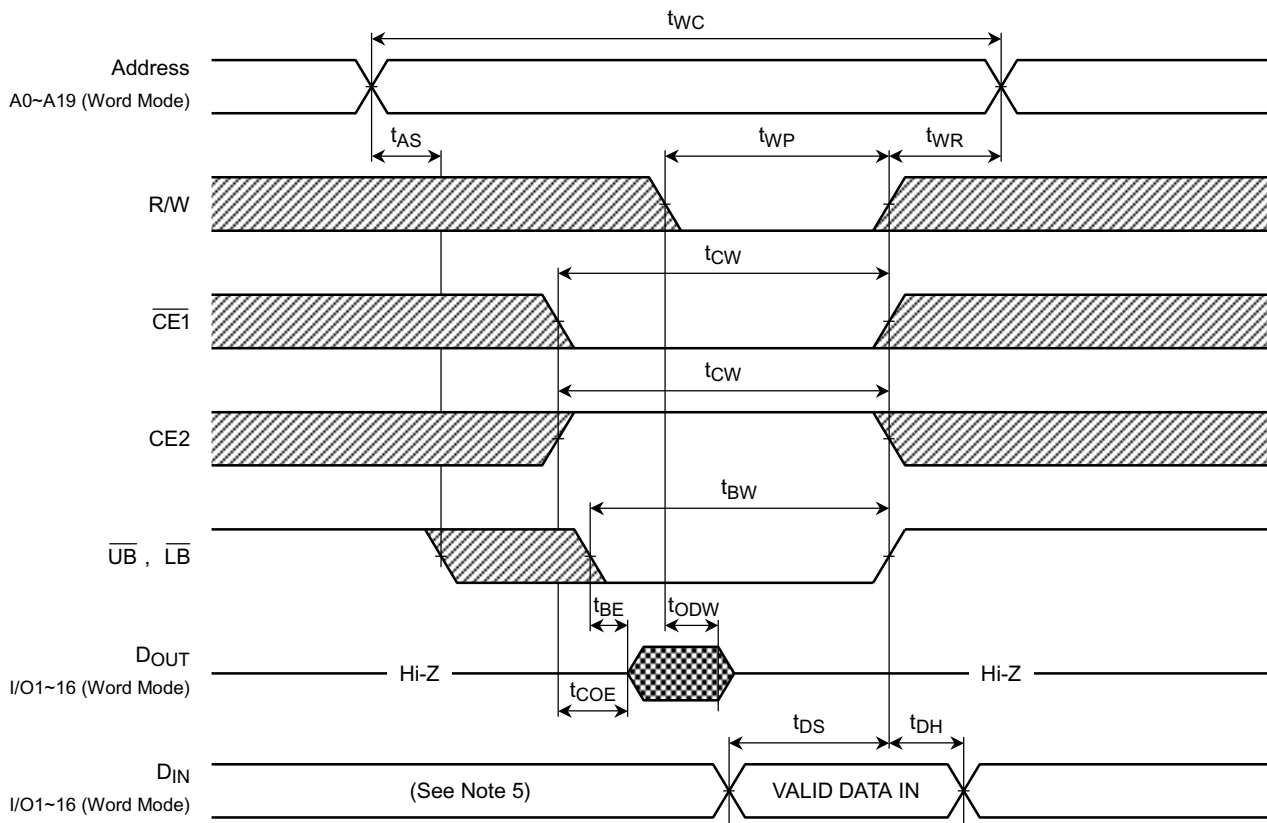

Note:

- (1) R/W remains HIGH for the read cycle.
- (2) If $\overline{CE1}$ (or \overline{UB} or \overline{LB}) goes LOW (or CE2 goes HIGH) coincident with or after R/W goes LOW, the outputs will remain at high impedance.
- (3) If $\overline{CE1}$ (or \overline{UB} or \overline{LB}) goes HIGH (or CE2 goes LOW) coincident with or before R/W goes HIGH, the outputs will remain at high impedance.
- (4) If \overline{OE} is HIGH during the write cycle, the outputs will remain at high impedance.
- (5) Because I/O signals may be in the output state at this time, input signals of reverse polarity must not be applied.

DATA RETENTION CHARACTERISTICS (Ta = -40° to 85°C)

SYMBOL	PARAMETER		MIN	TYP	MAX	UNIT	
V _{DH}	Data Retention Supply Voltage		1.5	—	3.6	V	
I _{DDS2}	Standby Current	V _{DH} = 3.6 V	Ta = -40~85°C	—	—	15	μA
		V _{DH} = 3.0 V	Ta = -40~40°C	—	—	3	
			Ta = -40~85°C	—	—	8	
t _{CDR}	Chip Deselect to Data Retention Mode Time		0	—	—	ns	
t _R	Recovery Time		5	—	—	ms	

CE1 CONTROLLED DATA RETENTION MODE (See Note 1)

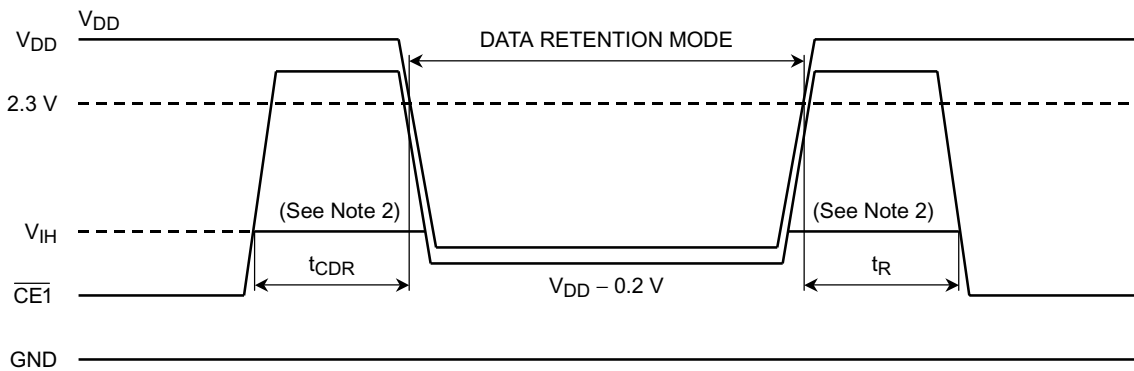

CE2 CONTROLLED DATA RETENTION MODE (See Note 3)

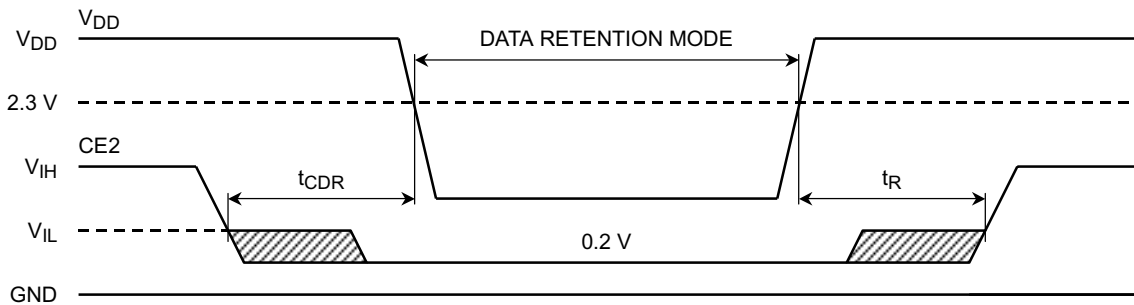

UB, LB CONTROLLED DATA RETENTION MODE (See Note 4)

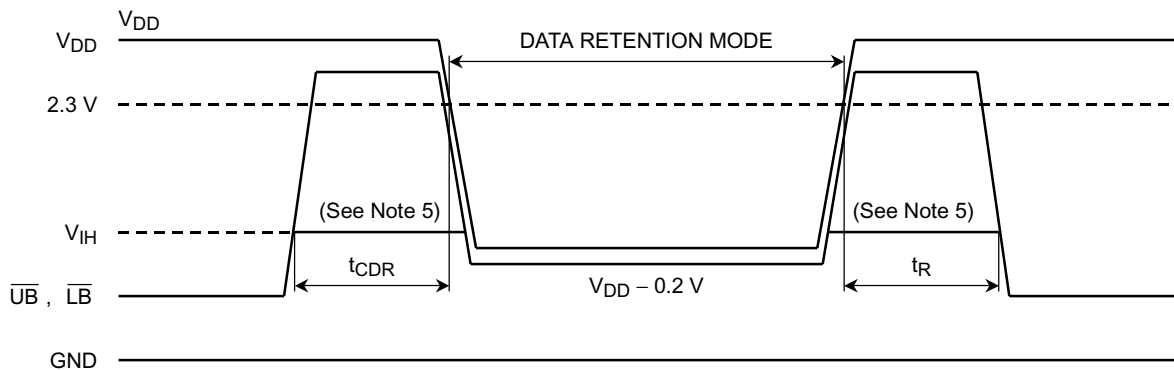

Note:

- (1) In $\overline{\text{CE1}}$ controlled data retention mode, minimum standby current mode is entered when $\text{CE2} \leq 0.2 \text{ V}$ or $\text{CE2} \geq \text{VDD} - 0.2 \text{ V}$.
- (2) When $\overline{\text{CE1}}$ is operating at the $\text{VIH}(\text{min.})$ level, the operating current is given by IDDS1 during the transition of VDD from 2.3(2.7) to 2.2V(2.4 V).
- (3) In CE2 controlled data retention mode, minimum standby current mode is entered when $\text{CE2} \leq 0.2 \text{ V}$.
- (4) In $\overline{\text{UB}}$ (or $\overline{\text{LB}}$) controlled data retention mode, minimum standby current mode is entered when $\overline{\text{CE1}} \leq 0.2 \text{ V}$ or $\overline{\text{CE1}} \geq \text{VDD} - 0.2 \text{ V}$, $\text{CE2} \leq 0.2 \text{ V}$ or $\text{CE2} \geq \text{VDD} - 0.2 \text{ V}$.
- (5) When $\overline{\text{UB}}$ (or $\overline{\text{LB}}$) is operating at the $\text{VIH}(\text{min.})$ level, the operating current is given by IDDS1 during the transition of VDD from 2.3(2.7) to 2.2V(2.4 V).

PACKAGE DIMENSIONS

TSOP 48-P-1220-0.50

Unit:mm

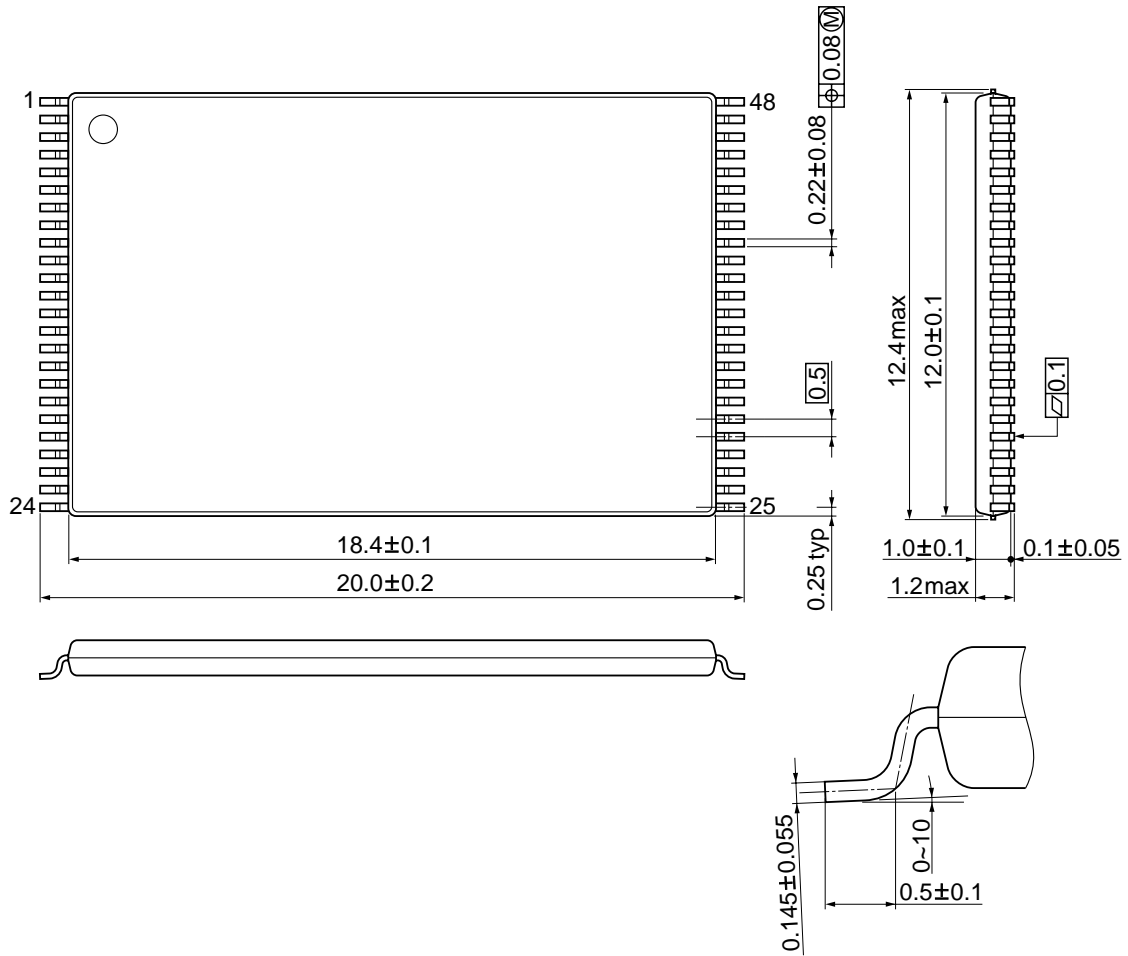

Weight:0.51 g (typ)

RESTRICTIONS ON PRODUCT USE

000707EBA

- TOSHIBA is continually working to improve the quality and reliability of its products. Nevertheless, semiconductor devices in general can malfunction or fail due to their inherent electrical sensitivity and vulnerability to physical stress. It is the responsibility of the buyer, when utilizing TOSHIBA products, to comply with the standards of safety in making a safe design for the entire system, and to avoid situations in which a malfunction or failure of such TOSHIBA products could cause loss of human life, bodily injury or damage to property.
In developing your designs, please ensure that TOSHIBA products are used within specified operating ranges as set forth in the most recent TOSHIBA products specifications. Also, please keep in mind the precautions and conditions set forth in the "Handling Guide for Semiconductor Devices," or "TOSHIBA Semiconductor Reliability Handbook" etc..
- The TOSHIBA products listed in this document are intended for usage in general electronics applications (computer, personal equipment, office equipment, measuring equipment, industrial robotics, domestic appliances, etc.). These TOSHIBA products are neither intended nor warranted for usage in equipment that requires extraordinarily high quality and/or reliability or a malfunction or failure of which may cause loss of human life or bodily injury ("Unintended Usage"). Unintended Usage include atomic energy control instruments, airplane or spaceship instruments, transportation instruments, traffic signal instruments, combustion control instruments, medical instruments, all types of safety devices, etc.. Unintended Usage of TOSHIBA products listed in this document shall be made at the customer's own risk.
- The products described in this document are subject to the foreign exchange and foreign trade laws.
- The information contained herein is presented only as a guide for the applications of our products. No responsibility is assumed by TOSHIBA CORPORATION for any infringements of intellectual property or other rights of the third parties which may result from its use. No license is granted by implication or otherwise under any intellectual property or other rights of TOSHIBA CORPORATION or others.
- The information contained herein is subject to change without notice.