

# Solid State Sensors

## Miniature Ratiometric Linear

SS490 Series

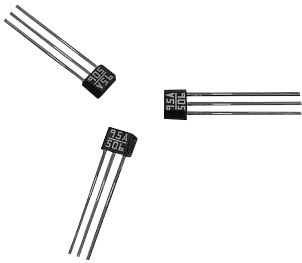

SS490 Series MRL (Miniature Ratiometric Linear) sensors have a ratiometric output voltage, set by the supply voltage. It varies in proportion to the strength of the magnetic field.

A new Hall effect integrated circuit chip provides increased temperature stability and sensitivity. Laser trimmed thin film resistors on the chip provide high accuracy (null to  $\pm 3\%$ , sensitivity up to  $\pm 3\%$ ) and temperature compensation to reduce null and gain shift over temperature. The quad Hall sensing element minimizes the effects of mechanical or thermal stress on the output. The positive temperature coefficient of the sensitivity ( $+0.02\%/^{\circ}\text{C}$  typical) helps compensate for the negative temperature coefficients of low cost magnets, providing a robust design over a wide temperature range.

### FEATURES

- Small size (.160 × .118")
- Low power consumption - typically 7 mA at 5 VDC
- Single current sinking or current sourcing linear output
- Built-in thin-film resistors - laser trimmed for precise sensitivity and temperature compensation
- Rail-to-rail operation provides more useable signal for higher accuracy
- Operating temperature range of  $-40$  to  $+150^{\circ}\text{C}$
- Responds to either positive or negative gauss
- Quad Hall sensing element for stable output

### NOTICE

Products ordered in bulk packaging (plastic bags) may not have perfectly straight leads as a result of normal handling and shipping operations. Please order tape packaging option for applications with critical lead straightness requirements.

### CIRCUIT BLOCK DIAGRAM

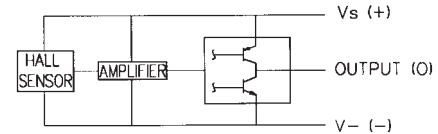

### SS495 SPECIFICATIONS, $V_s = 5.0\text{ V}$ , $T_A = -40$ to $+125^{\circ}\text{C}$ (unless otherwise noted)

Catalog Listings		SS495A* Standard	SS495A1* High Accuracy	SS495A2* Basic
Supply Voltage (VDC)		4.5 to 10.5	4.5 to 10.5	4.5 to 10.5
Supply Current @ $25^{\circ}\text{C}$ (mA)	Typ.	7.0	7.0	7.0
	Max.	8.7	8.7	8.7
Output Type (Sink or Source)		Ratiometric	Ratiometric	Ratiometric
Output Current (mA)	Typ. Source	$V_s > 4.5\text{V}$	1.5	1.5
	Min. Source	$V_s > 4.5\text{V}$	1.0	1.0
	Min. Sink	$V_s > 4.5\text{V}$	0.6	0.6
	Min. Sink	$V_s > 5.0\text{V}$	1.0	1.0
Magnetic Range	Typ.	$-670$ to $+670$ Gauss ( $-67$ to $+67$ mT)		
	Min.	$-600$ to $+600$ Gauss ( $-60$ to $+60$ mT)		
Output Voltage Span	Typ.	0.2 to ( $V_s - 0.2$ )	0.2 to ( $V_s - 0.2$ )	0.2 to ( $V_s - 0.2$ )
	Min.	0.4 to ( $V_s - 0.4$ )	0.4 to ( $V_s - 0.4$ )	0.4 to ( $V_s - 0.4$ )
Null (Output @ 0 Gauss, V)		$2.50 \pm 0.075$	$2.50 \pm 0.075$	$2.50 \pm 0.100$
Sensitivity (mV/G)		$3.125 \pm 0.125$	$3.125 \pm 0.094$	$3.125 \pm 0.156$
Linearity, % of Span	Typ.	$-1.0\%$	$-1.0\%$	$-1.0\%$
	Max.	$-1.5\%$	$-1.5\%$	$-1.5\%$
Temperature Error Null Drift ( $\%/^{\circ}\text{C}$ )		$\pm 0.06\%$	$\pm 0.04\%$	$\pm 0.07\%$
Sensitivity Drift ( $\%/^{\circ}\text{C}$ )	$\geq 25^{\circ}\text{C}$ Max.	$-0.01\% + 0.05\%$	$-0.01\% + 0.05\%$	$-0.02\% + 0.06\%$
	$< 25^{\circ}\text{C}$ Max.	$-0.00\% + 0.06\%$	$-0.00\% + 0.06\%$	$-0.01\% + 0.07\%$

\*Bulk, 1,000 per bag

To order Surface Mount: add -S suffix to listing. Example: SS495A-S.

To order tape in Ammopack style T2: add -T2 suffix to listing.

To order tape in Ammopack style T3: add -T3 suffix to listing.

To order tape in reel style P (surface mount): add -SP suffix to listing.

### NULL SHIFT VS TEMPERATURE

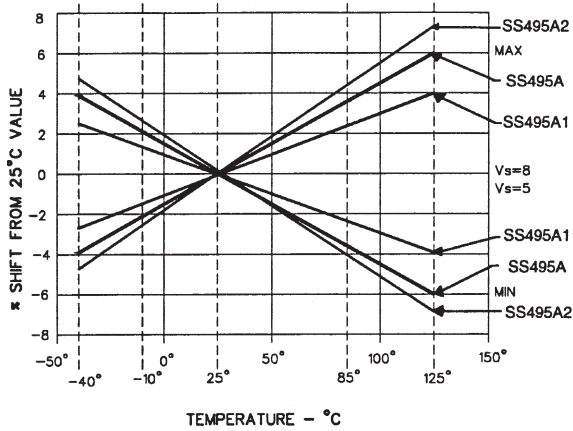

### SENSITIVITY SHIFT VS TEMPERATURE

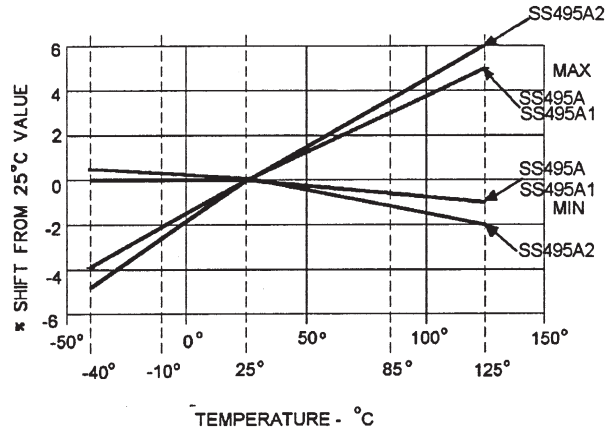

### TYP. FREQUENCY RESPONSE

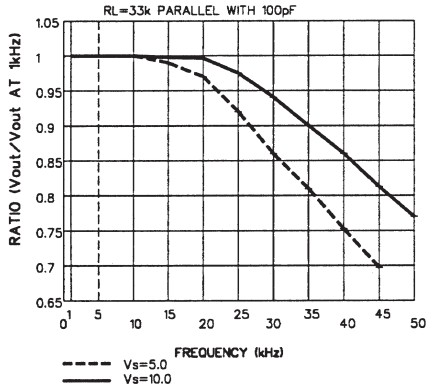

### RATIO OF V<sub>NULL</sub> TO V<sub>S</sub>

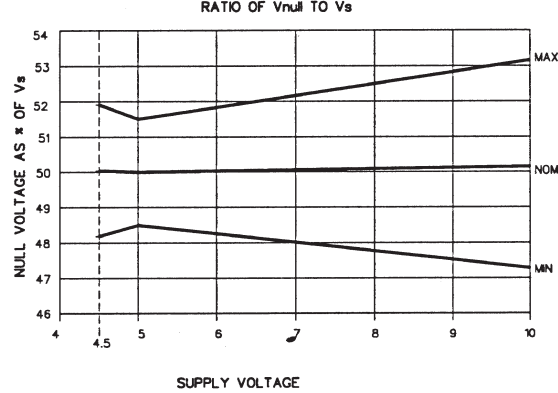

### LINEARITY VS V<sub>S</sub>

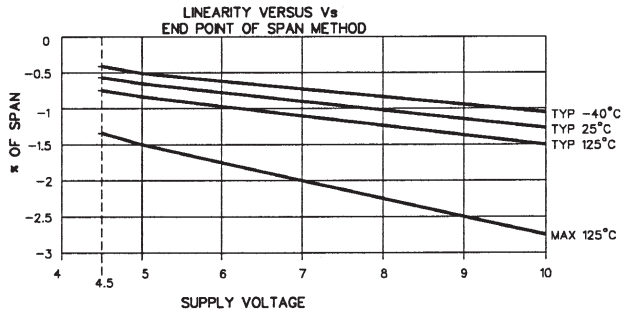

### SUPPLY CURRENT VS TEMPERATURE

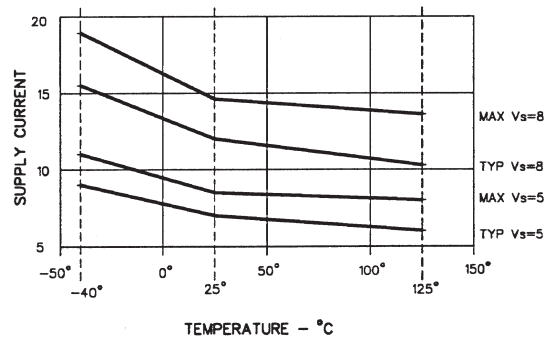

### TRANSFER CHARACTERISTICS V<sub>S</sub> 5.0 VDC

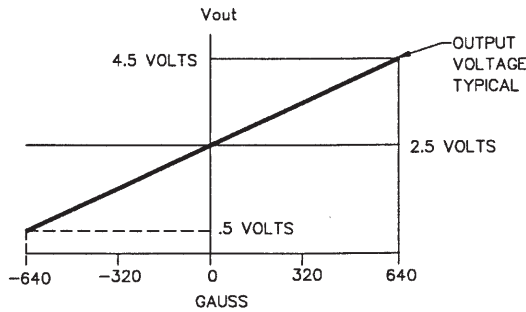

### SENSITIVITY/V VS V<sub>S</sub>

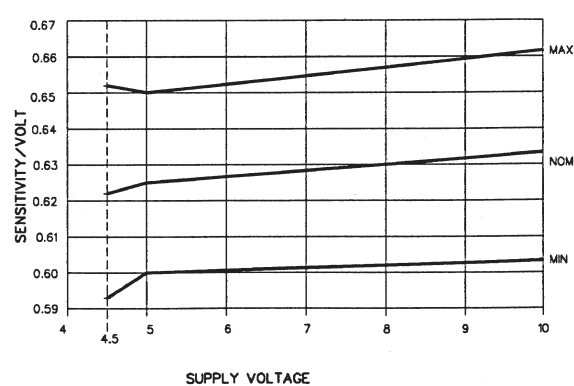

Analog

# Solid State Sensors

## Miniature Ratiometric Linear

SS490 Series

SS496 SPECIFICATIONS,  $V_s = 5.0\text{ V}$ ,  $T_A = -40\text{ to }+125^\circ\text{C}$  (unless otherwise noted)

Catalog Listings		SS496A Standard	SS496A1 High Accuracy
Supply Voltage, DC		4.5 to 10.5	4.5 to 10.5
Supply Current @ 25°C (mA)	Typ.	7.0	7.0
	Max.	8.7	8.7
Output Type (Sink or Source)		Ratiometric	Ratiometric
Output Current, mA	Typ. Source	$V_s > 4.5\text{ V}$	1.5
	Min. Source	$V_s > 4.5\text{ V}$	1.0
Min. Sink	$V_s > 4.5\text{ V}$	0.6	0.6
	$V_s > 5.0\text{ V}$	1.0	1.0
Magnetic Range	Typ.	-840 to +840 Gauss (-84 to +84 mT)	
	Min.	-750 to +750 Gauss (-75 to +75 mT)	
Output Voltage Span	Typ.	0.2 to $(V_s - 0.2)$	0.2 to $(V_s - 0.2)$
	Min.	0.4 to $(V_s - 0.4)$	0.4 to $(V_s - 0.4)$
Null (Output @ 0 Gauss, V)		$2.500 \pm 0.175$	$2.500 \pm 0.075$
Sensitivity (mV/G)		$2.500 \pm 0.100$	$2.50 \pm 0.075$
Linearity, % of Span	Typ.	-1.0%	-1.0%
	Max.	-1.5%	-1.5%
Temperature Error Null Drift (%/°C)		$\pm 0.048\%$	$\pm 0.032\%$
Sensitivity Drift (%/°C)	$\geq 25^\circ\text{C}$ Max.	-0.01, +0.05	-0.01, +0.06
	$< 25^\circ\text{C}$ Max.	-0.00, +0.06	-0.00, +0.06

### NULL SHIFT VS TEMPERATURE

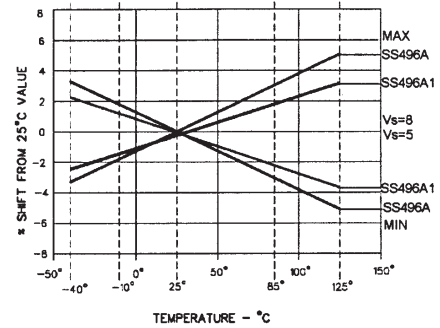

### TRANSFER CHARACTERISTICS @ $V_s = 5\text{ VDC}$

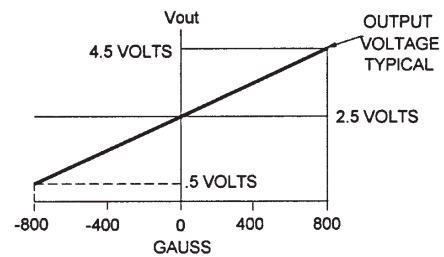

### SUPPLY CURRENT VS TEMP.

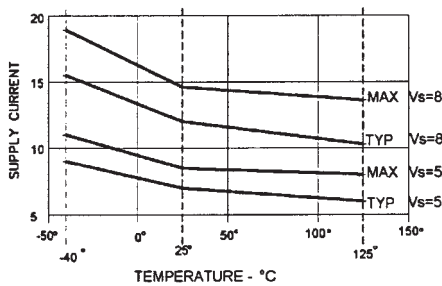

### TYP. FREQUENCY RESPONSE

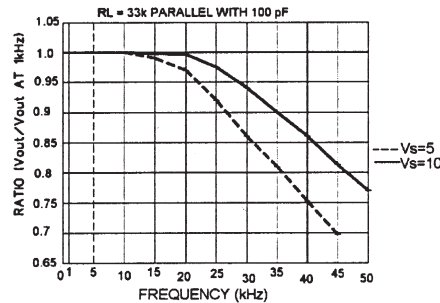

### SENSITIVITY SHIFT VS TEMP

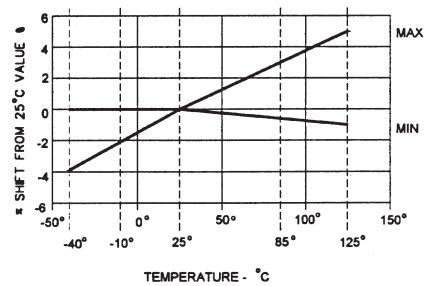

### SENSITIVITY/V VS $V_s$

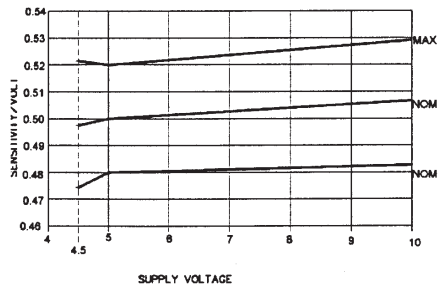

### LINEARITY VS $V_s$

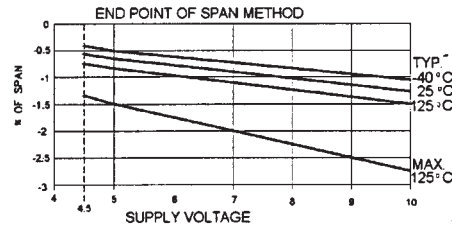

### RATIO OF $V_{NULL}$ TO $V_s$

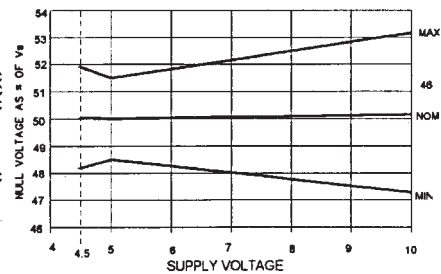

# Solid State Sensors

## Miniature Ratiometric Linear

SS490 Series

### MOUNTING DIMENSIONS (for reference only)

#### TAPE STYLE T2

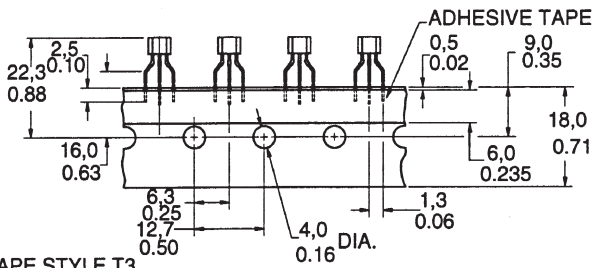

#### TAPE STYLE T3

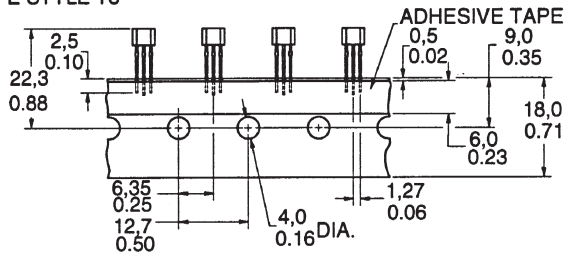

#### TAPE STYLE P

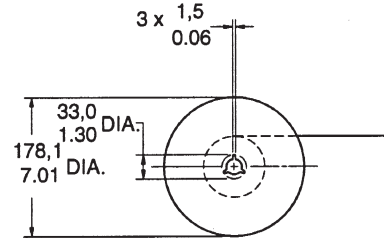
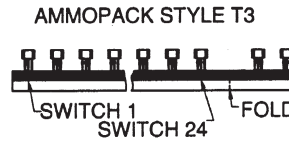
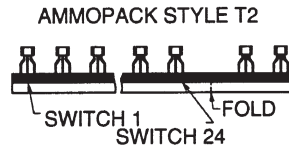
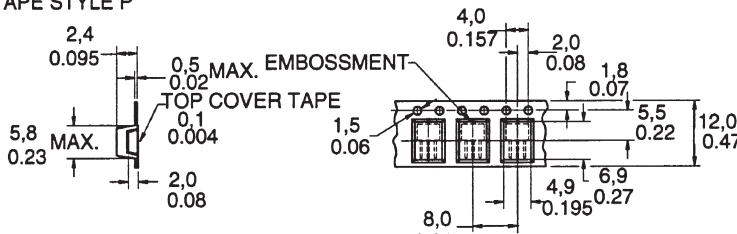

### SENSOR PACKAGE

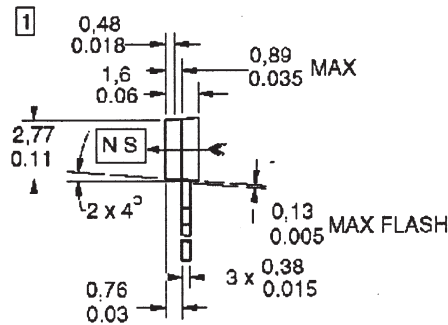
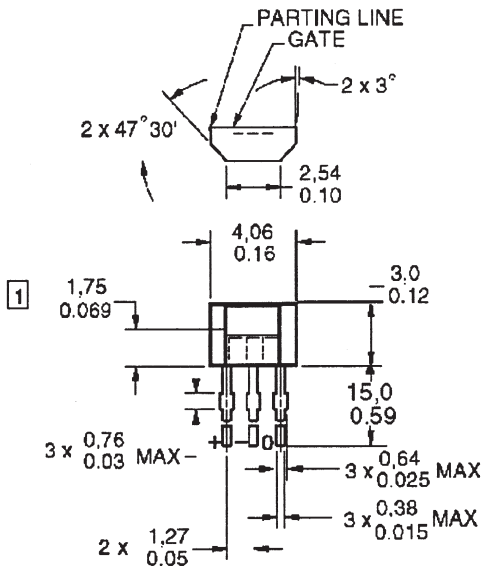

### OPTIONAL SURFACE MOUNT STYLE

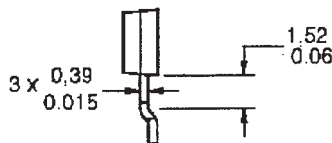
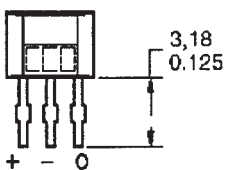

1 Centerline of Hall cell

Analog