

# Precision Adjustable Shunt Reference



## CL2431

### FEATURES

- Temperature-Compensated: 30ppm/°C
- Trimmed 0.5% Bandgap Reference
- Internal Amplifier with 100mA Capability
- Temperature Range: Extended to 0 to 105°C
- Low Frequency Dynamic Output Impedance: < 150mΩ
- Low Output Noise
- SOT-23 Replacement for TL431

### DESCRIPTION

The CL2431 is a three terminal adjustable voltage reference designed to act as an open-loop error amplifier with a 2.5V temperature compensated reference. Operating as a low temperature coefficient zener which is programmable from  $V_{REF}$  to 18V with two external resistors while providing a wide operating current range of 1.0mA to 100mA with a typical dynamic impedance of 0.15Ω. As a shunt regulator the device can be used as either a positive or negative voltage reference. Active output circuitry provides a very sharp turn-on characteristic, making the CL2431 an excellent replacement for low-voltage zener diodes in many applications, including on-board regulation and adjustable power supplies.

### ORDERING INFORMATION

Part	Package	Tolerance	Temperature Range
CL2431VS	SOT-23	1.0%	0 to +105°C
CL2431AVS	SOT-23	0.5%	0 to +105°C
CL2431IVS	SOT-23	1.0%	-40 to +85°C
CL2431IAVS	SOT-23	0.5%	-40 to +85°C

### PIN CONFIGURATION (Top View)

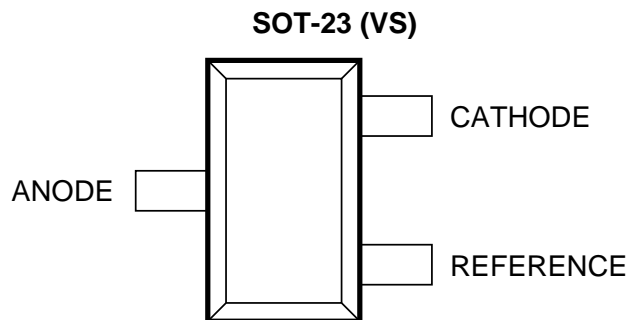

1J-22

**ABSOLUTE MAXIMUM RATINGS**

SYMBOL	PARAMETER	RATING	UNITS
V <sub>KA</sub>	Cathode-Anode Reverse Breakdown	18	V
I <sub>AK</sub>	Anode-Cathode Forward Current	1	A
I <sub>KA</sub>	Operating Cathode Current	100	mA
I <sub>REF</sub>	Reference Input Current	1	mA
P <sub>D</sub>	Continuous Power Dissipation at 25°C SOT-23	200	mW
T <sub>J</sub>	Junction Temperature	150	°C
T <sub>STG</sub>	Storage Temperature	-65 to 150	°C
T <sub>L</sub>	Lead Temperature, Soldering 10 Seconds	300	°C

Stresses greater than those listed under ABSOLUTE MAXIMUM RATINGS may cause permanent damage to the device. This is a stress rating only and functional operation of the device at these or any other conditions above those indicated in the operational sections of this specification is not implied. Exposure to absolute maximum rating conditions for extended periods may affect reliability.

**RECOMMENDED CONDITIONS**

SYMBOL	PARAMETER	RATING	UNIT
V <sub>KA</sub>	Cathode Voltage	V <sub>REF</sub> to 18	V
I <sub>K</sub>	Cathode Current	10	mA

**TYPICAL THERMAL RESISTANCES**

PACKAGE	θ <sub>JA</sub>	θ <sub>JC</sub>	TYPICAL DERATING
SOT-23	575°C/W	150°C/W	1.7mW/°C

**FUNCTIONAL BLOCK DIAGRAM**

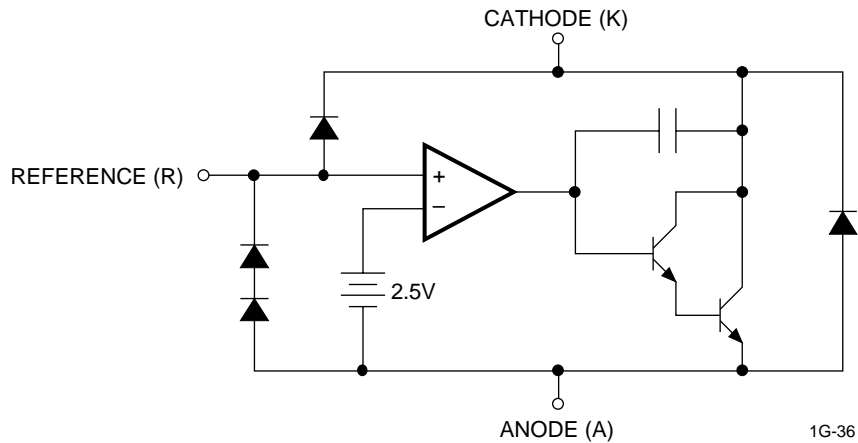

**ELECTRICAL CHARACTERISTICS**

Electrical characteristics are guaranteed over full junction temperature range (0 to 105°C). Ambient temperature must be derated based on power dissipation and package thermal characteristics. The conditions are:  $V_{KA} = V_{REF}$  and  $I_K = 10mA$  unless otherwise stated.

SYMBOL	PARAMETER	MIN	TYP	MAX	UNIT	CIRCUIT	TEST CONDITION
$V_{REF}$	Reference Voltage	2.490	2.500	2.515	V	1	$T_A = 25^\circ C$ , 0.5% CL2431A
		2.470	2.500	2.520	V	1	$T_A = 25^\circ C$ , 1.0% CL2431
TC	$\Delta V_{REF}$ with Temp.*		0.6	0.2	mV/°C	1	
$\frac{\Delta V_{REF}}{\Delta V_K}$	Ratio of Change in $V_{REF}$ to Cathode Voltage	-2.7	-1.01		mV/V	2	$V_{REF}$ to 10V
		-2	-0.4	0.3			10V to 18V
$I_{REF}$	Reference Input Current		0.7	4	$\mu A$	2	
$\Delta I_{REF}$	$I_{REF}$ Temp Deviation		0.4	1.2	$\mu A$	2	Over Temp.
$I_{K(MIN)}$	Min $I_K$ for Regulation		0.4	1	mA	1	
$I_{K(OFF)}$	Off State Leakage		0.04	250	nA	3	$V_{REF} = 0V$ , $V_{KA} = 18V$
$Z_{KA}$	Dynamic Output Impedance		0.15	0.5	$\Omega$	1	$f \leq 1kHz$ , $I_K = 1$ to 100mA

**\*CALCULATING AVERAGE TEMPERATURE COEFFICIENT (TC)**

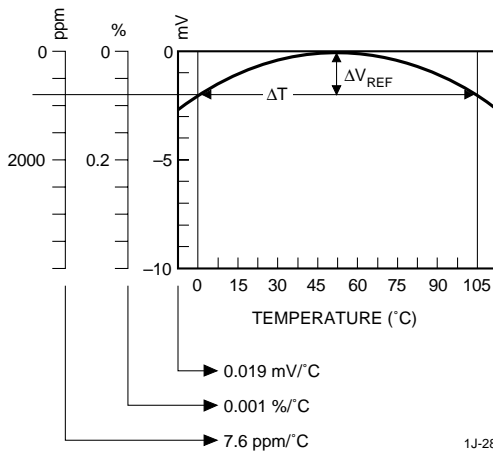

• TC in mV/°C =  $\frac{\Delta V_{REF} (mV)}{\Delta T_A}$

• TC in %/°C =  $\frac{\left(\frac{\Delta V_{REF}}{V_{REF} \text{ at } 25^\circ C}\right) \times 100}{\Delta T_A}$

• TC in ppm/°C =  $\frac{\left(\frac{\Delta V_{REF}}{V_{REF} \text{ at } 25^\circ C}\right) \times 10^6}{\Delta T_A}$

**TEST CIRCUITS**

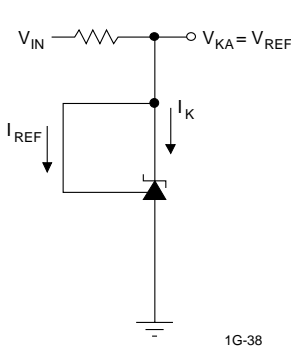

TEST CIRCUIT 1

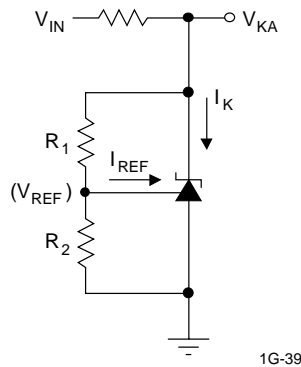

TEST CIRCUIT 2

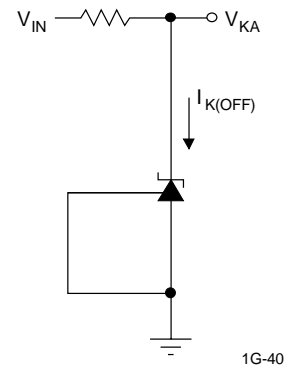

TEST CIRCUIT 3

**TYPICAL PERFORMANCE CURVES**

**LOW CURRENT OPERATING CHARACTERISTICS**

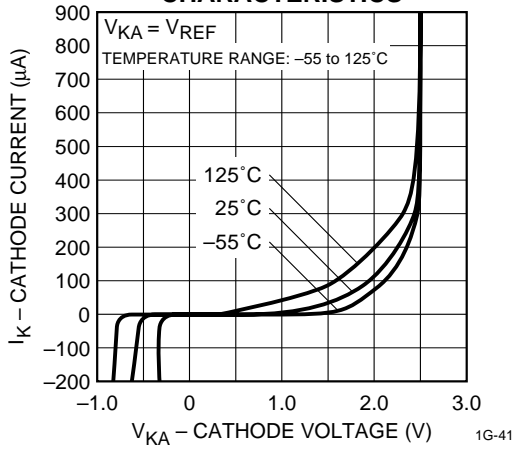

**HIGH CURRENT OPERATING CHARACTERISTICS**

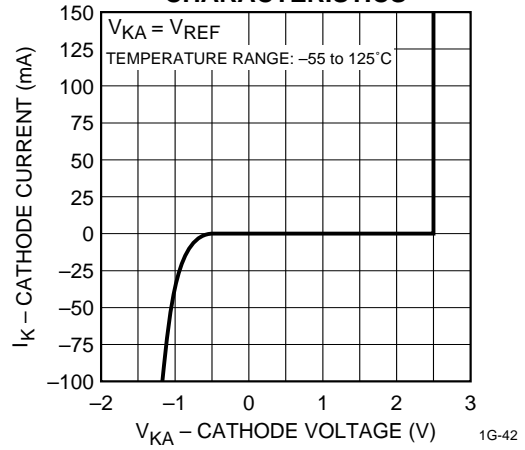

**OFF STATE LEAKAGE**

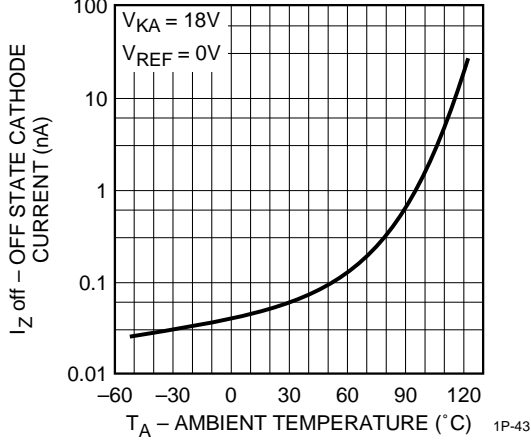

**TEMPERATURE COEFFICIENT AS A FUNCTION OF TRIM VALUE**

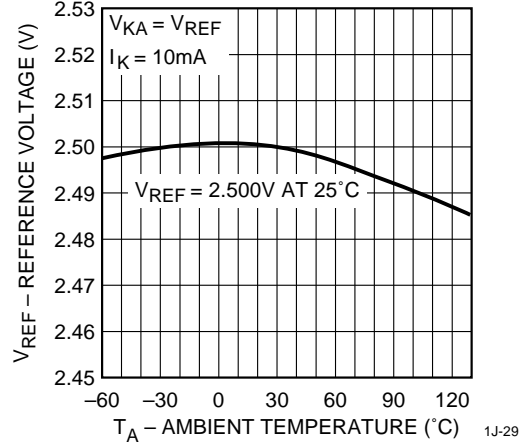

**REFERENCE INPUT CURRENT**

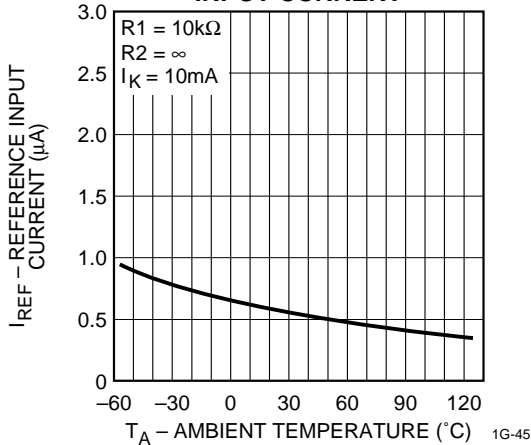

**REFERENCE VOLTAGE LINE REGULATION**

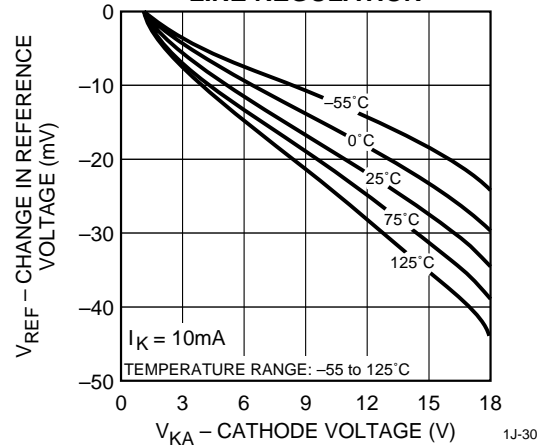

TYPICAL PERFORMANCE CURVES (continued)

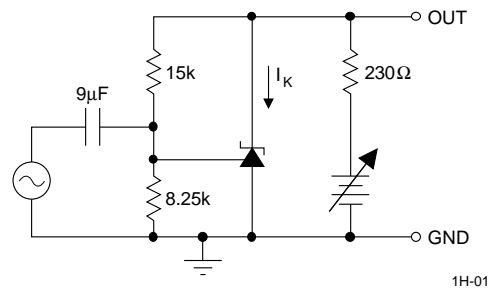
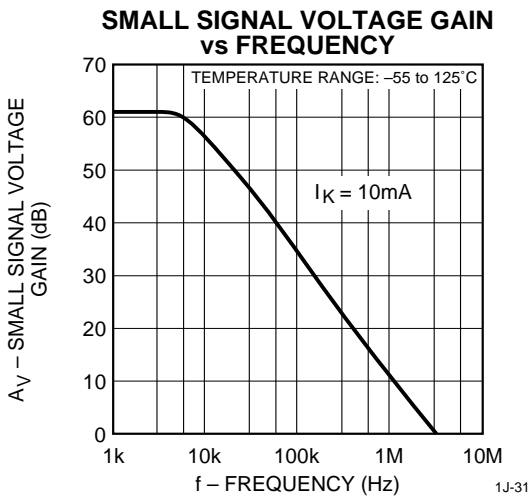
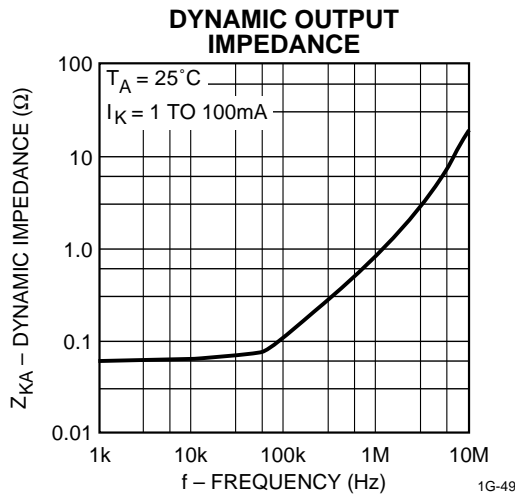
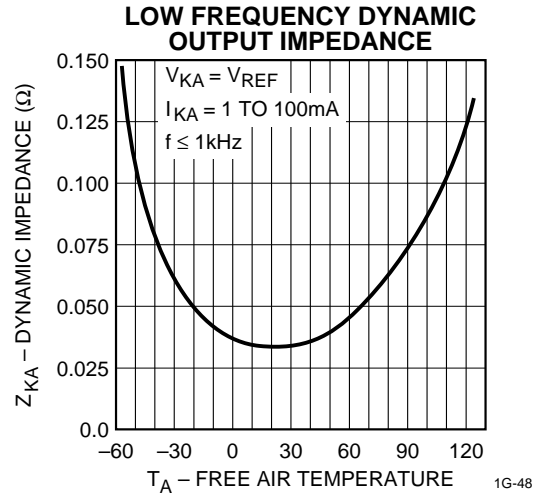
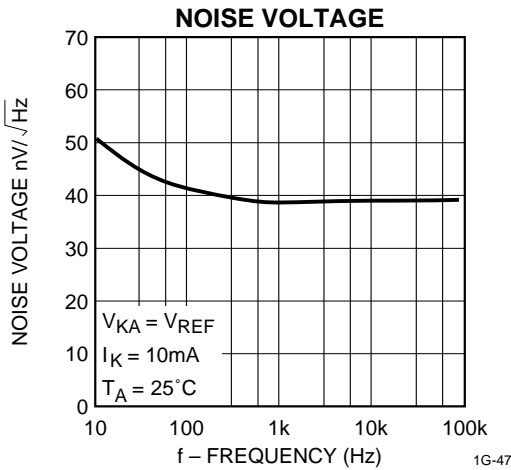

TYPICAL PERFORMANCE CURVES (continued)

