

**PRELIMINARY**

Notice: This is not a final specification.  
Some parametric limits are subject to change.

MITSUBISHI DIODE MODULES  
**RM20TPM-M,-H**  
MEDIUM POWER GENERAL USE  
INSULATED TYPE

**RM20TPM-M,-H**



- **I<sub>o</sub>** DC output current ..... **40A**
- **V<sub>RRM</sub>** Repetitive peak reverse voltage  
..... **400/800V**
- **3 phase bridge**
- **Insulated Type**

**APPLICATION**

AC motor controllers, DC motor controllers, Battery DC power supplies,  
DC power supplies for control panels, and other general DC power equipment

**OUTLINE DRAWING & CIRCUIT DIAGRAM**

Dimensions in mm

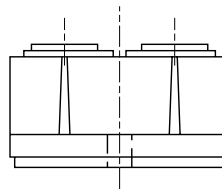
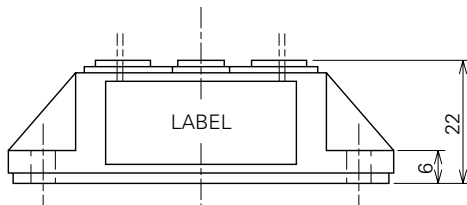
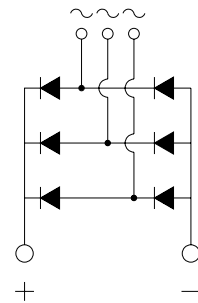
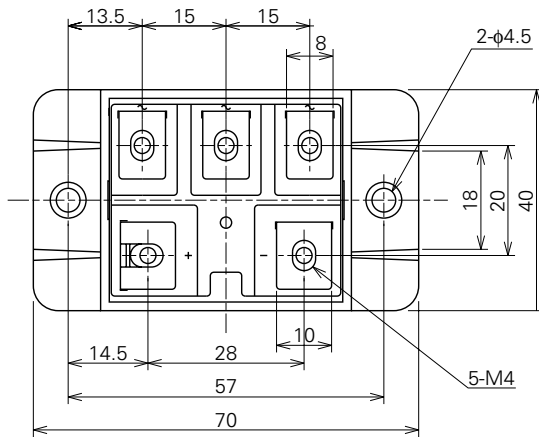

## RM20TPM-M,-H

MEDIUM POWER GENERAL USE

INSULATED TYPE

## ABSOLUTE MAXIMUM RATINGS

Symbol	Parameter	Voltage class		Unit
		M	H	
VRRM	Repetitive peak reverse voltage	400	800	V
VRSM	Non-repetitive peak reverse voltage	500	900	V
Ea	Recommended AC input voltage	110	220	V

Symbol	Parameter	Conditions	Ratings	Unit
Io	DC output current	Three-phase full wave rectifying circuit, Tc=125°C	40	A
IFSM	Surge (non-repetitive) forward current	One half cycle at 60Hz, peak value	400	A
I <sup>2</sup> <sub>t</sub>	I <sup>2</sup> <sub>t</sub> for fusing	Value for one cycle of surge current	4.2 × 10 <sup>3</sup>	A <sup>2</sup> s
f	Maximum operating frequency		1000	Hz
T <sub>j</sub>	Junction temperature		-40~+150	°C
T <sub>stg</sub>	Storage temperature		-40~+125	°C
V <sub>iso</sub>	Isolation voltage	Charged part to case	2500	V
—	Mounting torque	Main terminal screw M4	0.98~1.47	N·m
			10~15	kg·cm
		Mounting screw M4	0.98~1.47	N·m
			10~15	kg·cm
—	Weight	Typical value	100	g

## ELECTRICAL CHARACTERISTICS

Symbol	Parameter	Test conditions	Limits			Unit
			Min.	Typ.	Max.	
I <sub>RRM</sub>	Repetitive reverse current	T <sub>j</sub> =150°C, V <sub>RRM</sub> applied	—	—	10	mA
V <sub>FM</sub>	Forward voltage	T <sub>j</sub> =25°C, I <sub>FM</sub> =40A, instantaneous meas.	—	—	1.2	V
R <sub>th(j-c)</sub>	Thermal resistance	Junction to case	—	—	0.33	°C/W
R <sub>th(c-f)</sub>	Contact thermal resistance	Case to fin, conductive grease applied	—	—	0.09	°C/W
—	Insulation resistance	Measured with a 500V megohmmeter between main terminal and case	10	—	—	MΩ

# RM20TPM-M,-H

MEDIUM POWER GENERAL USE  
INSULATED TYPE

## PERFORMANCE CURVES

MAXIMUM FORWARD CHARACTERISTIC

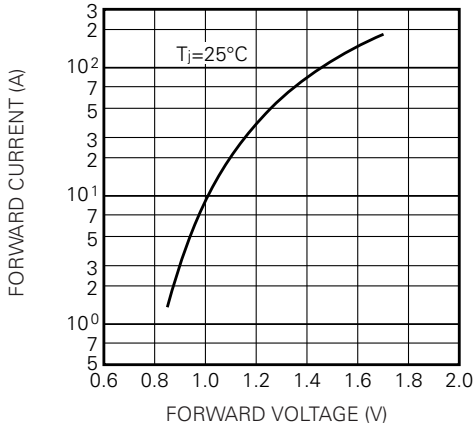

ALLOWABLE SURGE (NON-REPETITIVE) FORWARD CURRENT

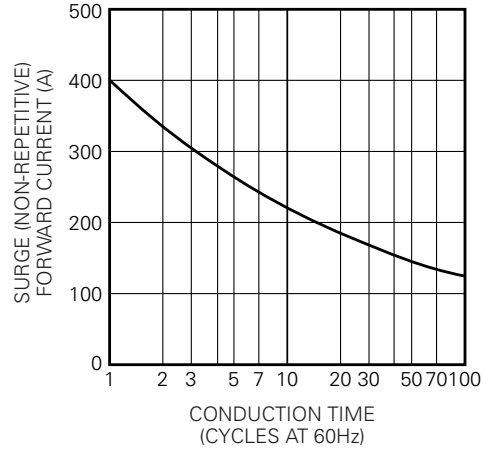

MAXIMUM TRANSIENT THERMAL IMPEDANCE (JUNCTION TO CASE)

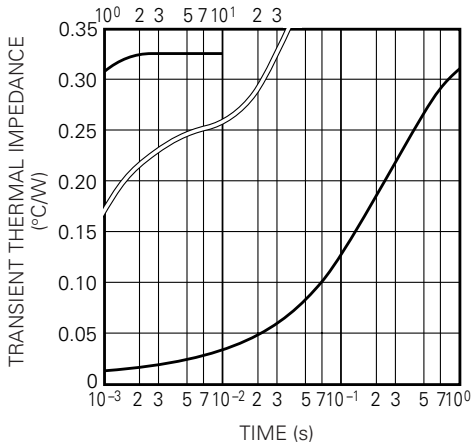

MAXIMUM POWER DISSIPATION

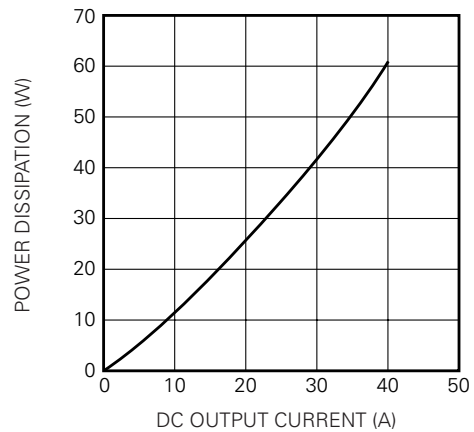

ALLOWABLE CASE TEMPERATURE VS. DC OUTPUT CURRENT

