

DF40SC3L Forward Voltage

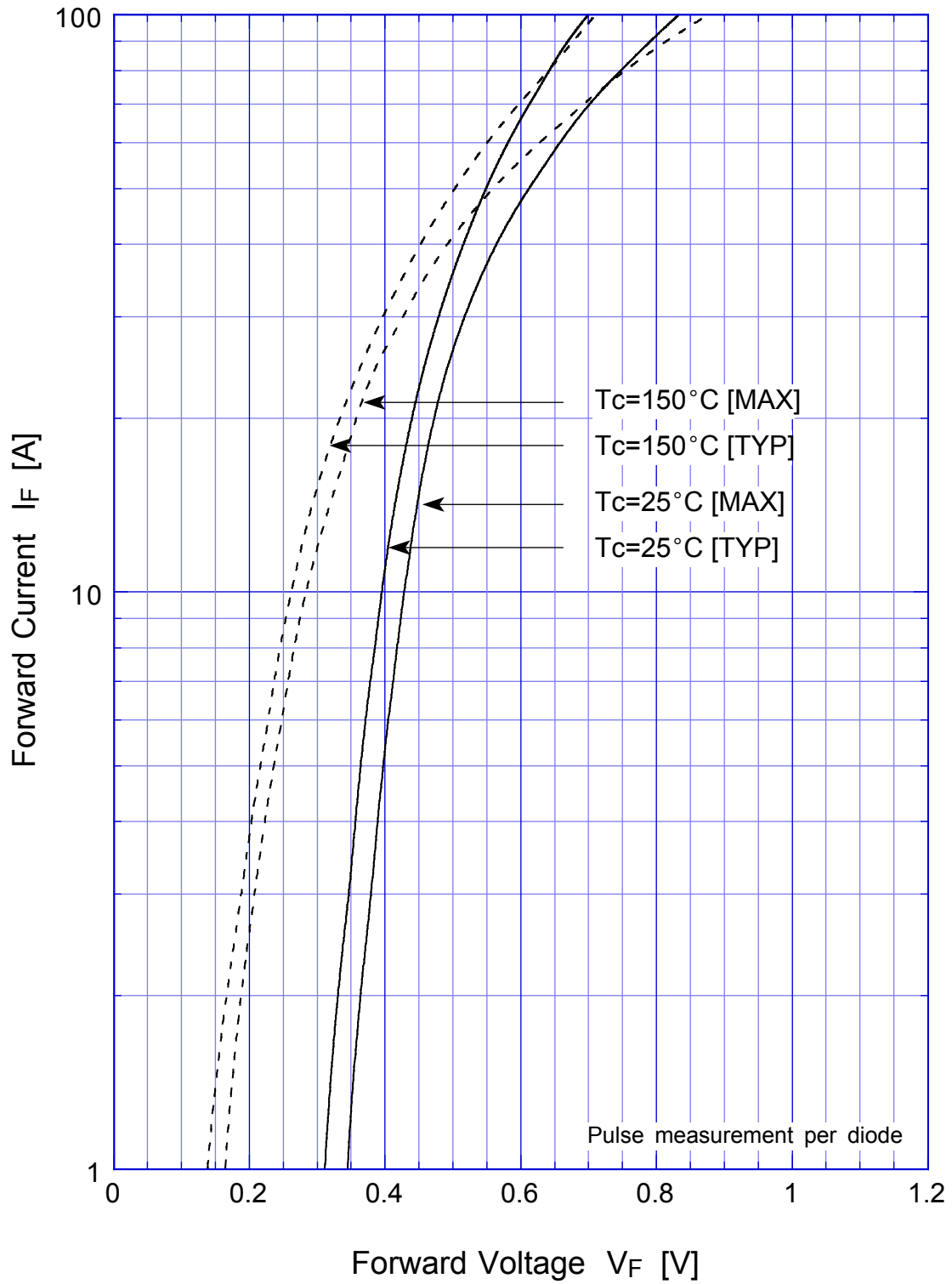

DF40SC3L Junction Capacitance

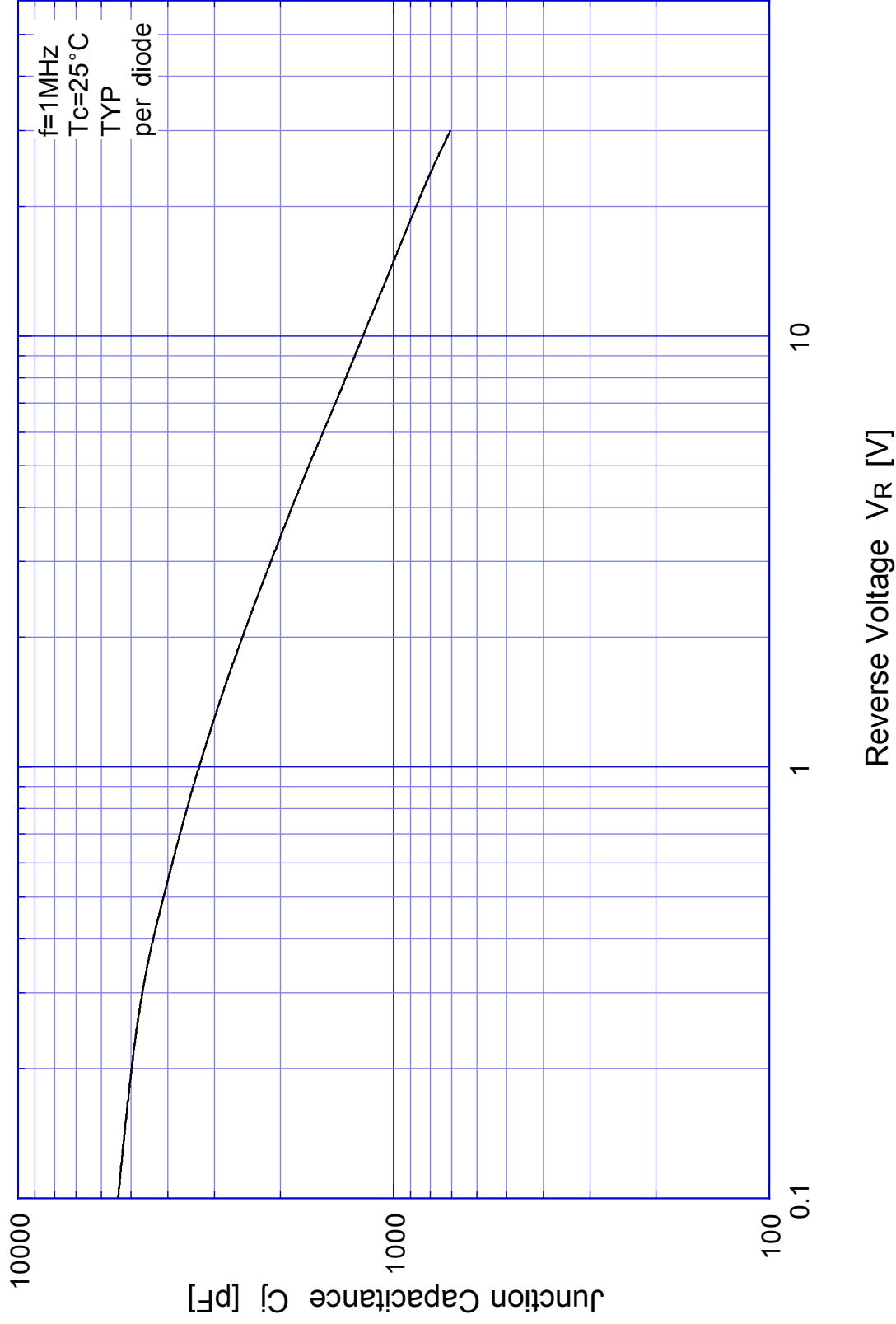

DF40SC3L Reverse Current

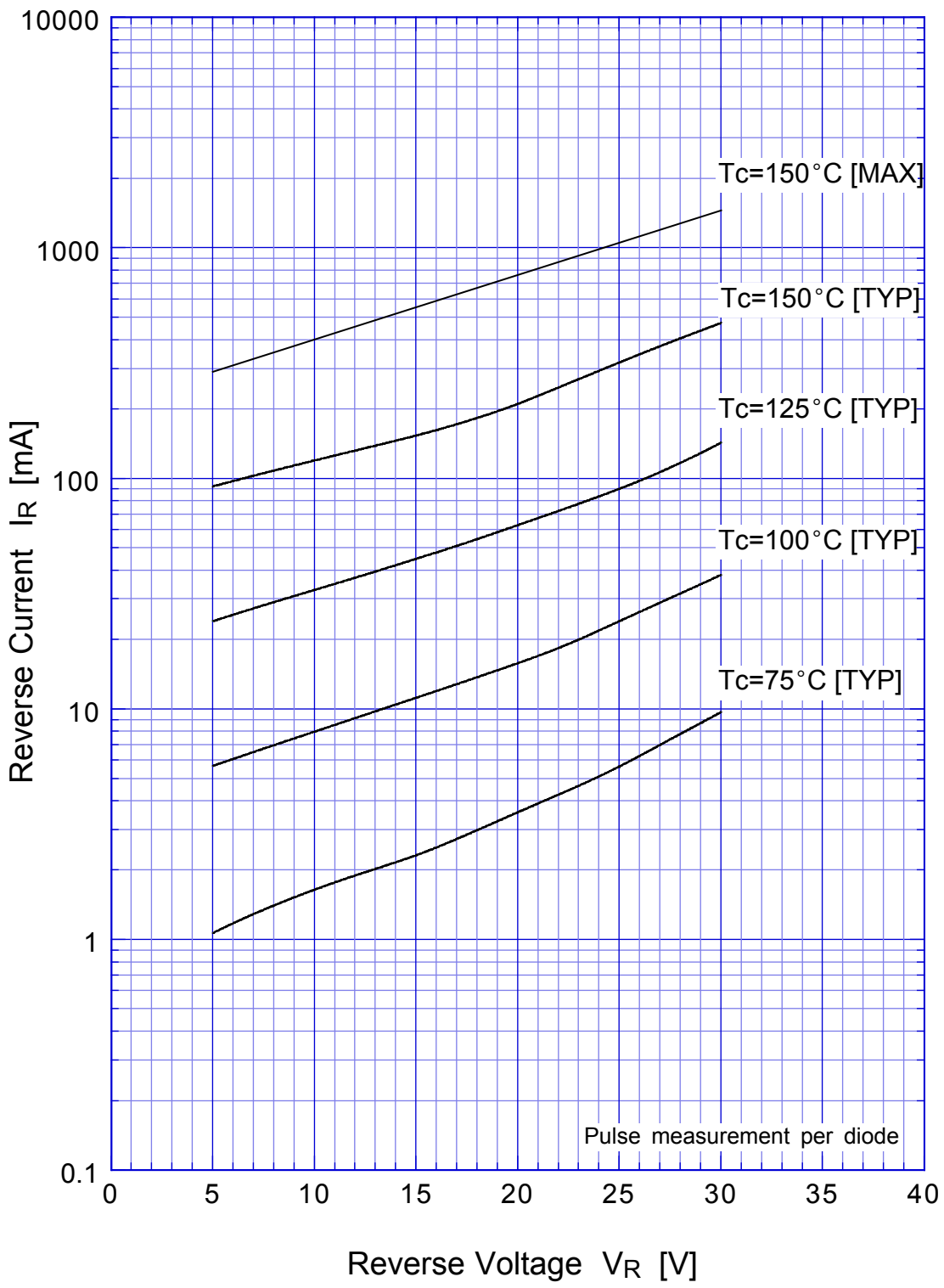

DF40SC3L Reverse Power Dissipation

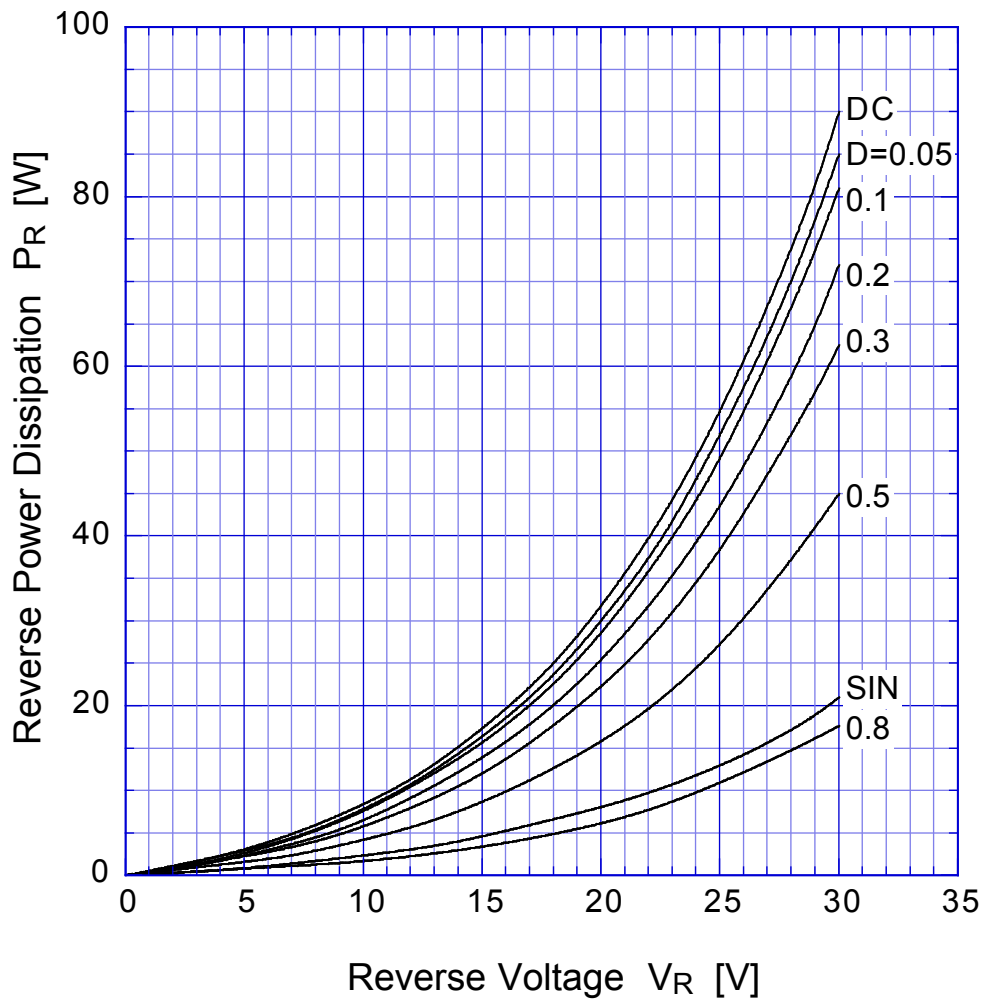

$T_j = 150^\circ\text{C}$

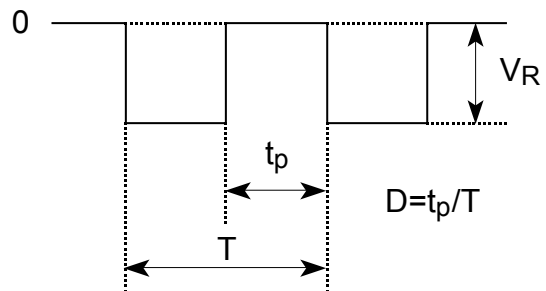

DF40SC3L Forward Power Dissipation

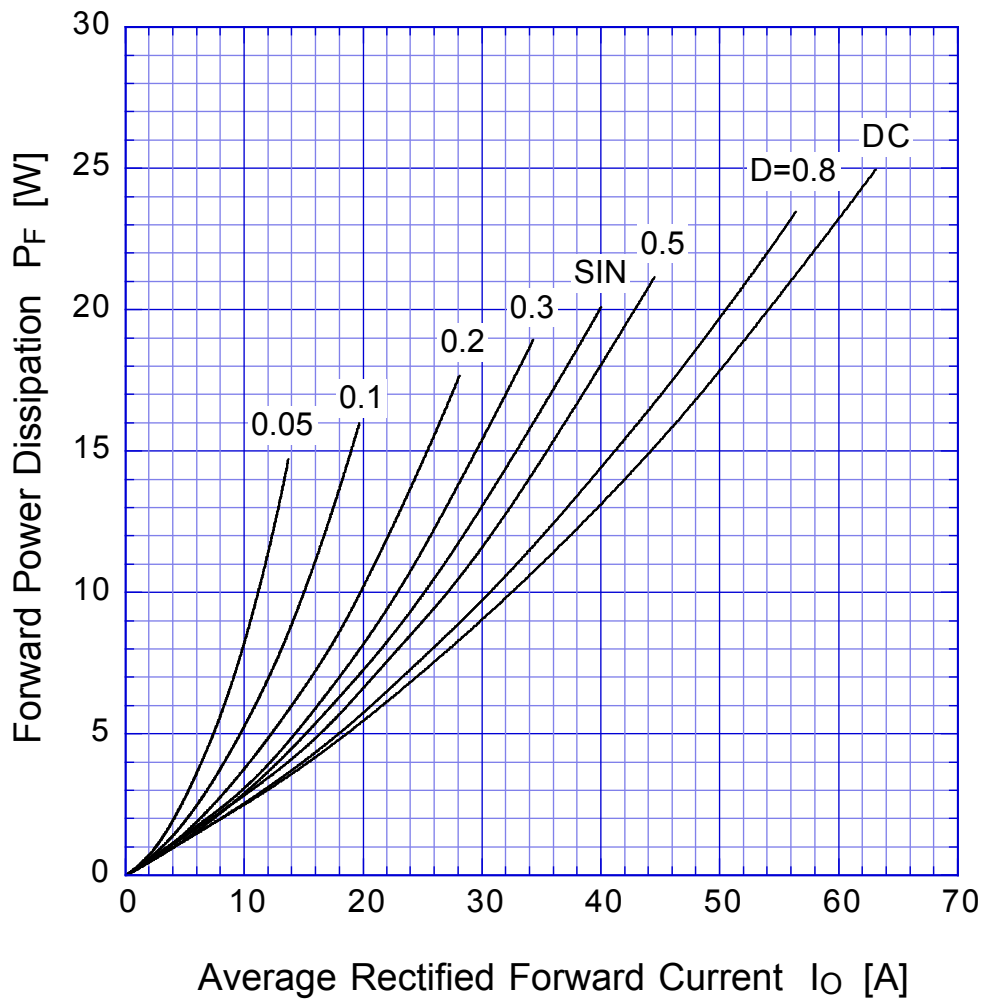

$T_j = 150^\circ\text{C}$

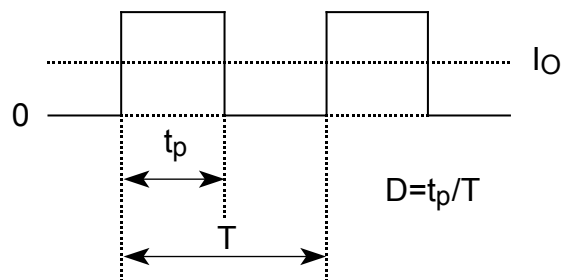

DF40SC3L

Derating Curve

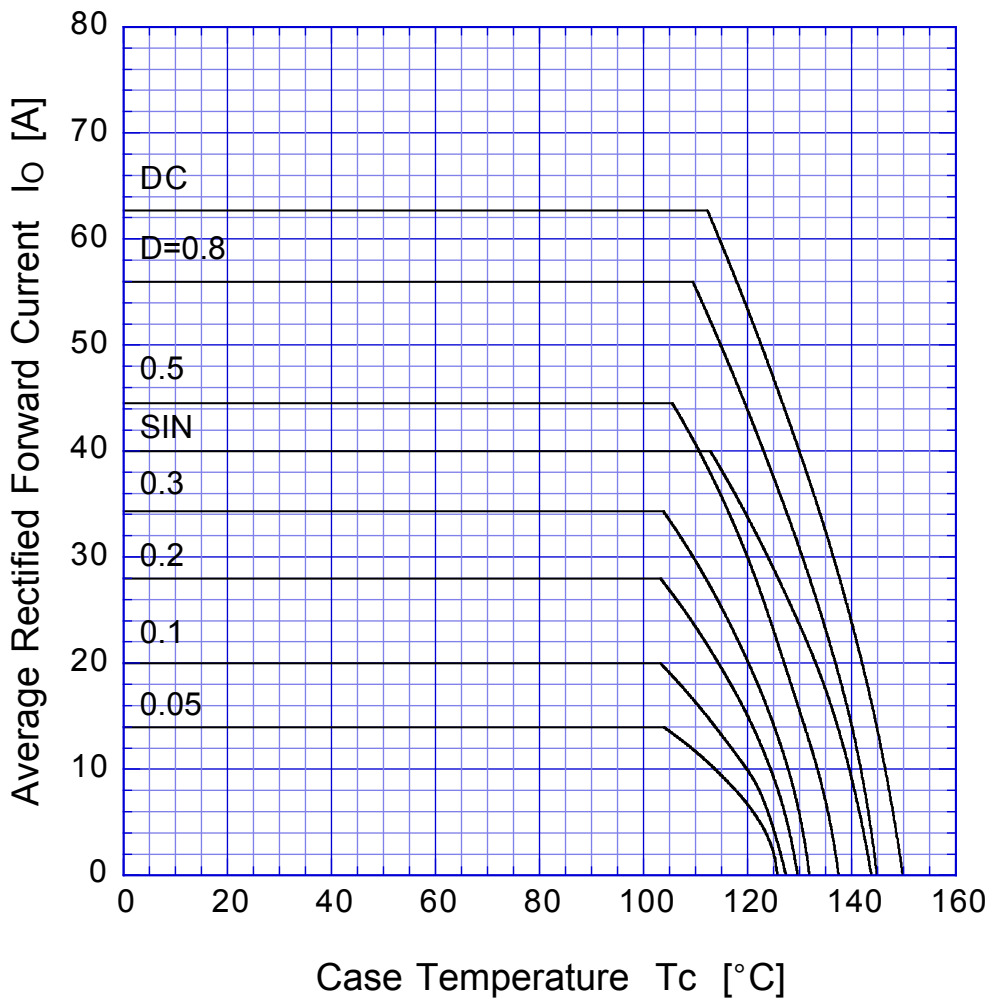

$V_R = 15V$

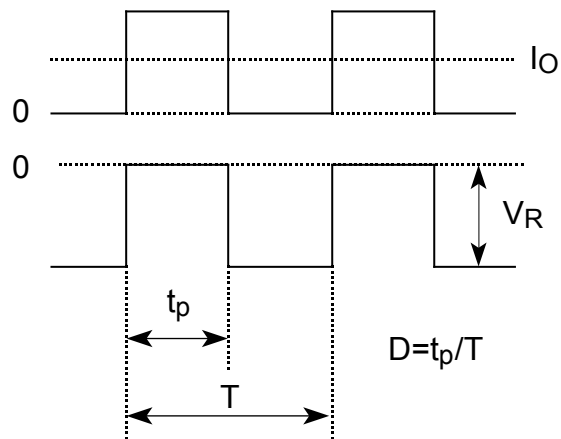

DF40SC3L Peak Surge Forward Capability

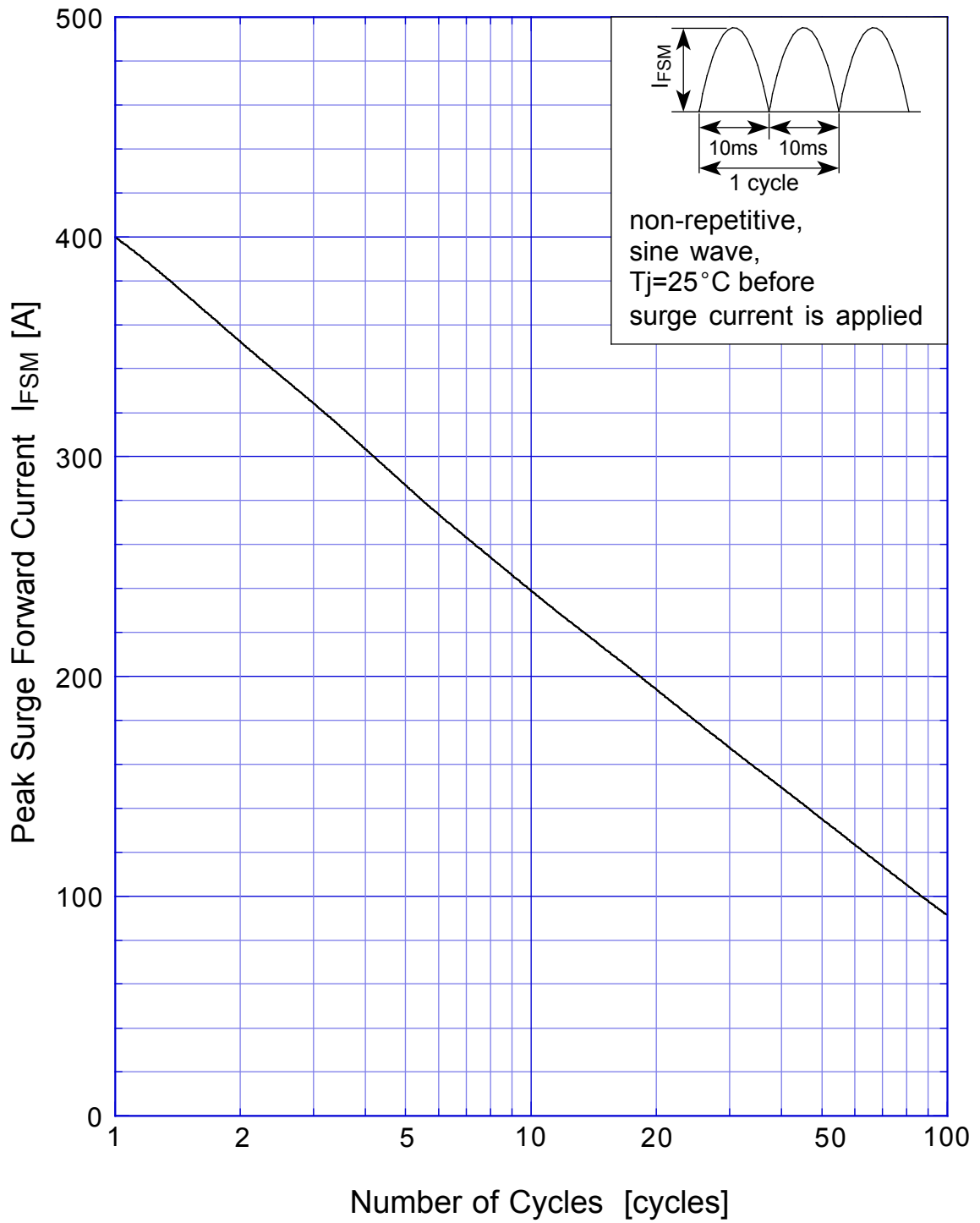

SBD Repetitive Surge Reverse Power Derating Curve

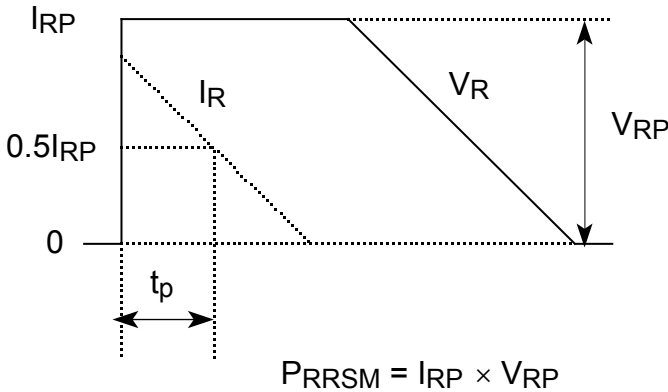
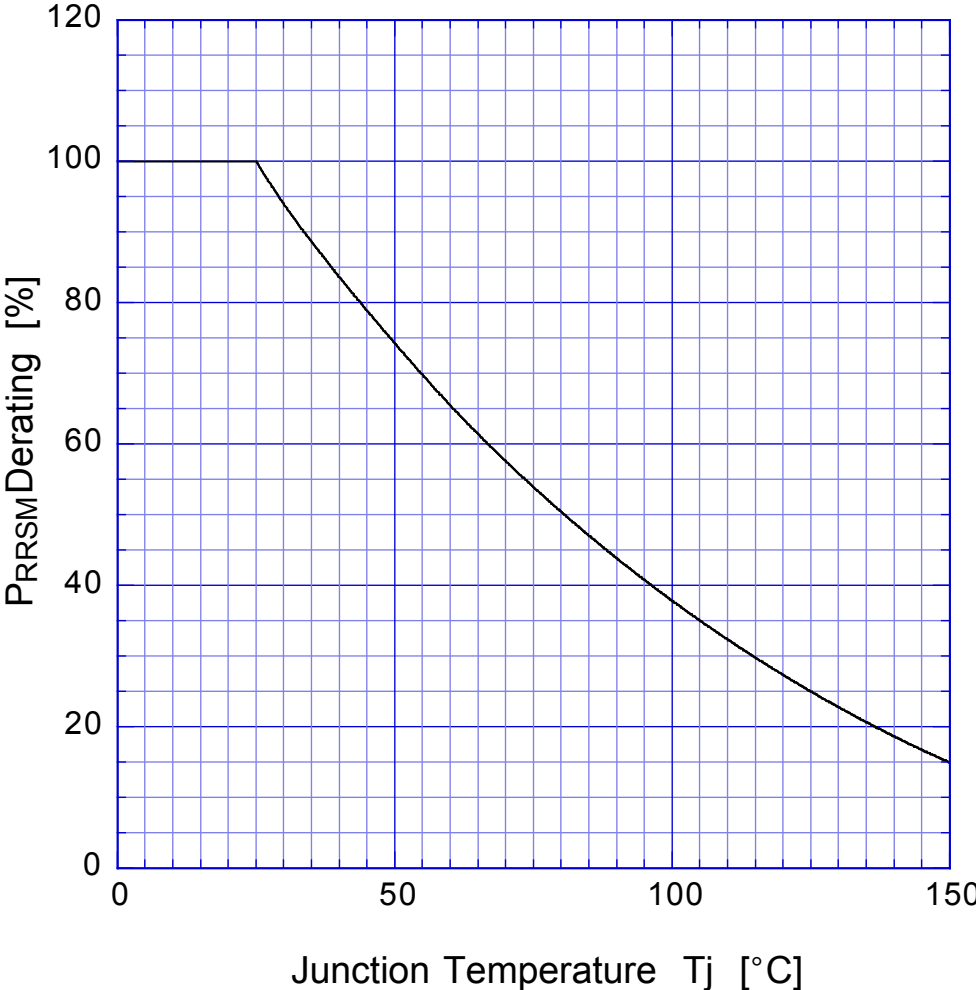

SBD

Repetitive Surge Reverse Power Capability

