

# C&K A Series 1-4 Pole Rotary Switches

## Features/Benefits

- Multi-pole and multi-position
- Positive detent
- Shorting & non-shorting contacts
- Panel and PCB mounting

## Typical Applications

- Automotive
- Major and small appliances
- Industrial equipment



## Specifications

CONTACT RATING: Q contact material: Switch - 2.5 AMPS @ 125 V AC; 350 mA @ 125 V DC (UL/CSA). Carry - 5 AMPS continuous. See page L-6 for additional ratings.

ELECTRICAL LIFE: 15,000 make-and-break cycles at full load up to 300,000 detent operations.

CONTACT RESISTANCE: Below 20 m Ω typ. initial @ 2-4 V DC, 100 mA, for both silver and gold plated contacts.

INSULATION RESISTANCE: 10<sup>9</sup> Ω min.

DIELECTRIC STRENGTH: 1,000 Vrms min. @ sea level.  
Operating and storage temp: -30° to 85°C

OPERATING & STORAGE TEMPERATURE: -30°C to 85°C

**NOTE:** Any models supplied with Q, B or G contact material are RoHS compliant. For the latest information regarding RoHS compliance, please go to: [www.ittcannon.com/rohs](http://www.ittcannon.com/rohs).

**NOTE:** Specifications and materials listed above are for switches with standard options. For information on specific and custom switches, consult Customer Service Center.

## Materials

HOUSING & BUSHING: Glass filled 6/6 nylon (UL 94V-0).

ACTUATOR: Glass filled 6/6 nylon (UL 94V-0).

MOVABLE CONTACTS: Q contact material: Coin silver, silver plated. See page L-6 for additional contact materials.

STATIONARY CONTACTS & TERMINALS: Q contact material: Brass, silver plated. See page L-6 for additional contact materials.

HARDWARE: Nut - zinc, nickel plated. Lockwasher — steel, bright zinc plated. Stop Ring - brass, nickel plated.

TERMINAL SEAL: Epoxy.

## Build-A-Switch

To order, simply select desired option from each category and place in the appropriate box. Available options are shown and described on pages L-4 through L-7. For additional options not shown in catalog, consult Customer Service Center.

<p><b>Switch Function</b></p> <p><b>A100</b> SP, 30° Index, 12 pos. no stops  <b>A102</b> SPDT, 30° Index  <b>A103</b> SP, 30° Index, 3 pos.  <b>A104</b> SP, 30° Index, 4 pos.  <b>A105</b> SP, 30° Index, 5 pos.  <b>A106</b> SP, 30° Index, 6 pos.  <b>A107</b> SP, 30° Index, 7 pos.  <b>A108</b> SP, 30° Index, 8 pos.  <b>A109</b> SP, 30° Index, 9 pos.  <b>A110</b> SP, 30° Index, 10 pos.  <b>A112</b> SP, 30° Index, 12 pos.  <b>A114</b> SP, 90° Index, 2 pos.  <b>A115</b> SP, 45° Index, 3 pos.  <b>A124</b> SP, 90° Index, 4 pos.  <b>A125</b> SP, 45° Index, 8 pos.  <b>A203</b> DP, 30° Index, 3 pos.  <b>A204</b> DP, 30° Index, 4 pos.  <b>A205</b> DP, 30° Index, 5 pos.  <b>A206</b> DP, 30° Index, 6 pos.  <b>A214</b> DP, 90° Index, 2 pos.  <b>A303</b> 3P, 30° Index, 3 pos.  <b>A304</b> 3P, 30° Index, 4 pos.  <b>A402</b> 4PDT, 30° Index  <b>A403</b> 4P, 30° Index, 3 pos</p>	<p><b>Actuator</b></p> <p><b>15</b> 1.500" high, flatted  <b>03</b> .375" high, flatted  <b>05</b> .500" high, flatted  <b>14</b> 1.500" high, flatted  <b>42</b> 1.654" high, metric  <b>S1</b> Screwdriver Slot</p>	<p><b>Mounting Style</b></p> <p><b>R</b> 3/8-32 threaded  <b>M</b> M10 x .75 metric</p>	<p><b>Shorting/ Non-shorting Contacts</b></p> <p><b>N</b> Non-shorting contacts  <b>S</b> Shorting contacts          (Not available with models A114, A124 &amp; A214)</p>	<p><b>Terminations</b></p> <p><b>Z</b> Solder lug  <b>C</b> PC Thru-hole  <b>MC</b> Modular base</p>	<p><b>Contact Material</b></p> <p><b>Q</b> Silver  <b>B</b> Gold  <b>G</b> Gold over silver</p>	<p><b>Seal</b></p> <p><b>NONE</b> No seal  <b>E</b> Epoxy seal  <b>F</b> Splashproof bushing seal  <b>K</b> Epoxy &amp; splashproof bushing seal</p>
--	---	---	--	--	---	--

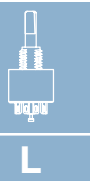

Rotary



Dimensions are shown: Inch (mm)  
Specifications and dimensions subject to change

# C&K A Series 1-4 Pole Rotary Switches

## SWITCH FUNCTION

30° INDEXING			
NO. POLES	MODEL NO.	SWITCH FUNCTION	TERMINALS
SP	A100	12 Position No Stops	A,1-12
	A102	SPDT	A,1,2*
	A103	3 Position	A,1-3*
	A104	4 Position	A,1-4*
	A105	5 Position	A,1-5*
	A106	6 Position	A,1-6*
	A107	7 Position	A,1-7
	A108	8 Position	A,1-8
	A109	9 Position	A,1-9
	A110	10 Position	A,1-10
A112	12 Position	A,1-12	
DP	A203	3 Position	A,C,1-3,7-9
	A204	4 Position	A,C,1-4,7-10
	A205	5 Position	A,C,1-5,7-11
	A206	6 Position	A,C,1-12
3P	A303	3 Position	A,B,C,1-3,5-7 9-11
	A304	4 Position	A,B,C,1-12

### SP MODELS SCHEMATIC

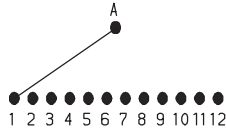

### DP MODELS SCHEMATIC

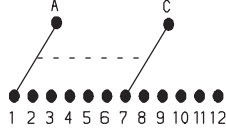

### 3P MODELS SCHEMATIC

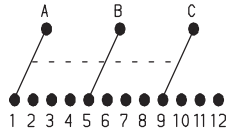

### 4P MODELS SCHEMATIC

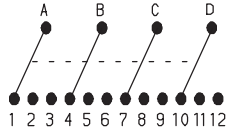

30° INDEXING			
NO. POLES	MODEL NO.	SWITCH FUNCTION	TERMINALS
4P	A402	4PDT	A,B,C,D,1,2,4,5,7, 8,10,11
	A403	3 Position	All Terminals

45° INDEXING			
NO. POLES	MODEL NO.	SWITCH FUNCTION	TERMINALS
SP	A115	3 Position	A,1,2,4*
	A125	8 Position	A,1,2,4,5,7,8,10,11

90° INDEXING			
NO. POLES	MODEL NO.	SWITCH FUNCTION	TERMINALS
SP	A114	2 Position	A,1,4*
	A124	4 Position	A,1,4,7,10
DP	A214	2 Position	A,C,1,4,7,10

### TERMINAL NUMBERS

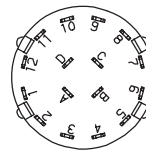

Terminal numbers molded on bottom of housing.

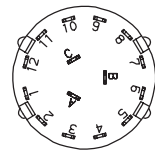

3P MODELS

4P MODELS  
SP MODELS (omit terminals B, C & D)  
DP MODELS (omit terminals B & D)

**NOTE:** \* These models with 'C' or 'MC' terminations have additional terminal no. 9 as switch support only. This terminal is not connected electrically inside switch.

All models with all options when ordered with 'G' or 'Q' contact material, see page L-6.

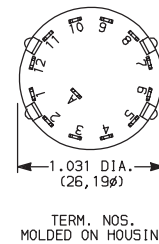
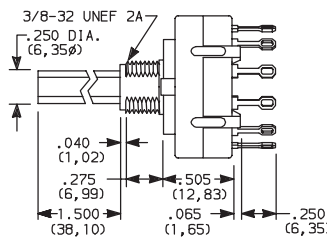
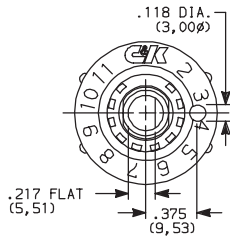

Dimensions are shown: Inch (mm)  
Specifications and dimensions subject to change

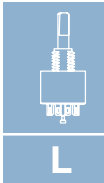

Rotary

# C&K A Series 1-4 Pole Rotary Switches

## ACTUATOR

- 15** 1.500" HIGH    **03** .375" HIGH    **05** .500" HIGH    **14** 1.500" HIGH    **42** 1.654" METRIC    **S1** SCREWDRIVER SLOT

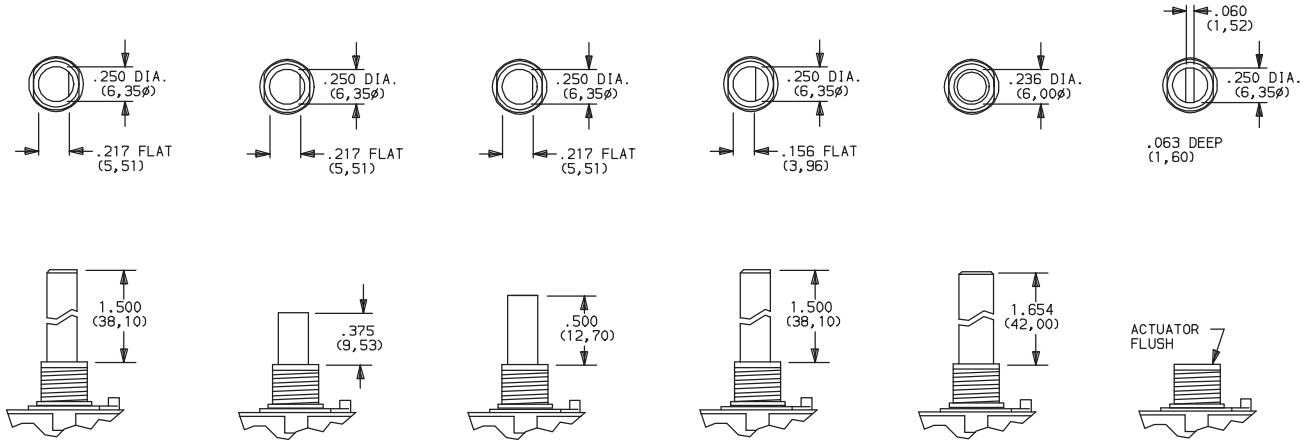

NOTE: Actuators shown in position 1, fully CCW.

## MOUNTING STYLE

- R** 3/8-32 THREAD    **M** M10 x .75 METRIC

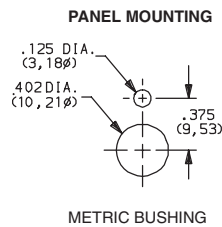
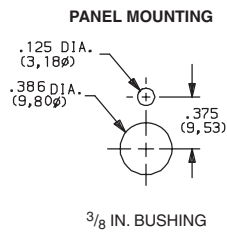
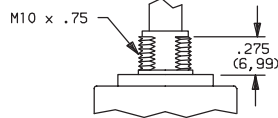
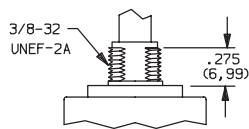

### TYPICAL INSTALLATION

Maximum force to push on knob should not exceed 10 in./lbs.

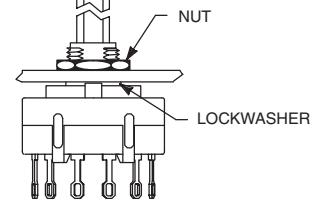

Install switch with stop ring (if used) and lockwasher in back of panel. Tighten hex nut from front of panel.

On PC mounted switches, use hex nut and lockwasher to hold stop ring in place.

Actuation torque: 8-16 oz./in.  
Maximum torque: 30 oz./in.

## SHORTING/NON-SHORTING CONTACTS

- N** NON-SHORTING CONTACTS (break-before-make)  
**S** SHORTING CONTACTS (make-before-break)

NOTE: 'S' shorting contacts are not available with A114, A124 and A214 models.

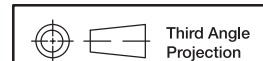

Dimensions are shown: Inch (mm)  
Specifications and dimensions subject to change

www.ittcannon.com

# C&K A Series 1-4 Pole Rotary Switches

## TERMINATIONS

### Z SOLDER LUG

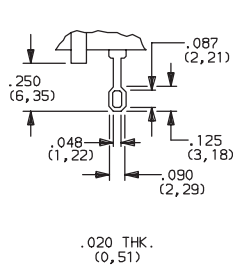

### C PC THRU-HOLE

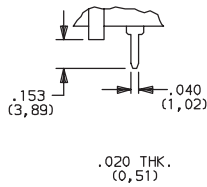

### MC MODULAR BASE (for wave soldering)

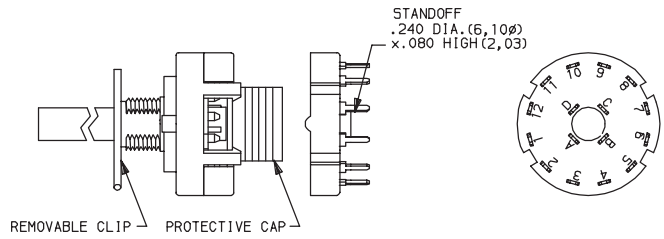

**NOTE:** Switches with 'C' or 'MC' terminations have additional terminal no. 9 as switch support only. This terminal is not connected electrically inside switch. Solder and clean switch base on PC board with other components, then snap on housing/actuator assembly. See page L-7 for installation instructions.

### PC MOUNTING

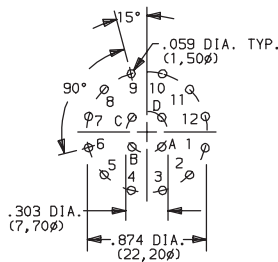

4P MODEL  
SP MODEL (omit terminals B, C & D)  
DP MODEL (omit terminals B & D)

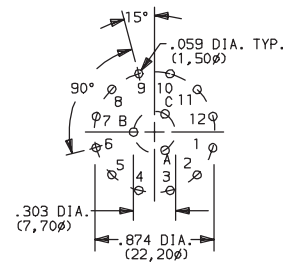

3P MODEL

## CONTACT MATERIAL

OPTION CODE	RoHS COMPLIANT*	RoHS COMPATIBLE*	CONTACT AND TERMINAL MATERIAL	RATING	
<b>Q</b>	YES	YES	SILVER <sup>2</sup>	POWER	SWITCH-2.5 AMPS @ 125 V AC; 350 mA @ 125V DC (UL/CSA). CARRY-5 AMPS CONTINUOUS.
<b>B</b>	YES	YES	GOLD <sup>1</sup>	LOW LEVEL/DRY CIRCUIT	0.4 VA MAX. @ 20 V AC or DC MAX
<b>G</b>	YES	YES	GOLD OVER SILVER <sup>3</sup>	LOW LEVEL/DRY CIRCUIT OR POWER	0.4 VA MAX. @ 20 V AC or DC MAX. or SWITCH-2.5 AMPS @ 125 V AC; 350 mA @ 125 V DC (UL/CSA). CARRY-5 AMPS CONTINUOUS.

\* Note: See Technical Data section of this catalog for RoHS compliant and compatible definition and specifications.

<sup>1</sup> MOVABLE CONTACTS: Copper alloy, with gold plate over nickel plate.  
STATIONARY CONTACTS & TERMINALS: Brass, with gold plate over nickel plate.

<sup>2</sup> MOVABLE CONTACTS: Coin silver, silver plated.

STATIONARY CONTACTS & TERMINALS: Brass, silver plated (standard with all termination options).

<sup>3</sup> MOVABLE CONTACTS: Coin silver, with gold plate over nickel plate over silver plate.  
STATIONARY CONTACTS & TERMINALS: Brass, with gold plate over nickel plate over silver plate.

**NOTE:** Any models supplied with Q, B or G contact material are RoHS compliant. For the latest information regarding RoHS compliance, please go to: [www.ittcannon.com/rohs](http://www.ittcannon.com/rohs).

All models  with all options when ordered with 'G' or 'Q' contact material.

**NOTE:** 'G' contact material is equivalent to both 'B' and 'Q' contact materials.



Dimensions are shown: Inch (mm)  
Specifications and dimensions subject to change

[www.ittcannon.com](http://www.ittcannon.com)

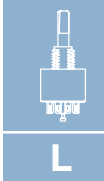

Rotary

# C&K A Series 1-4 Pole Rotary Switches

## FUNCTION

**NONE** NO SEAL

**E** EPOXY SEAL

**F** SPLASHPROOF BUSHING SEAL

**K** EPOXY & SPLASHPROOF BUSHING SEAL

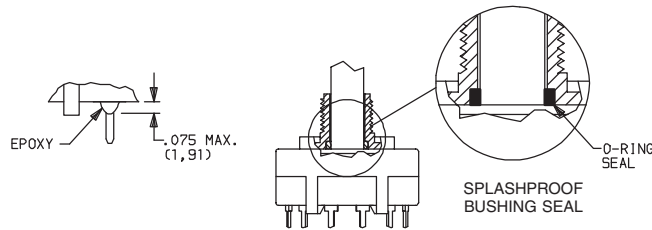

### Setting Stops on A112 and A125 Models

The number of switch positions is adjustable on A112 and A125 models only by means of a stop ring provided with each switch. The number of positions is pre-set on all other models and the stop ring is factory installed.

To set stops: Turn shaft fully counter-clockwise and insert stop ring tab in desired hole. Install lockwasher and nut to retain stop ring for both PC and panel mounting. Switch without stop ring has 12 positions.

### Soldering, Cleaning and Assembly Instructions for 'MC' Termination Option

#### Soldering

1. Insert switch base only into PC board.
2. Do not bend terminals.
3. Wave soldering recommended at 500F solder temperature.
4. Hand solder at 500F, 10 sec. max./terminal.

#### Cleaning

1. Flux clean using vapor degreaser and forced rinse or triple bath method.
2. Do not allow switch base to 'trap' fluids.
3. Freon TMC, TF or Methylene Chloride give excellent results.

#### Switch Assembly

1. Hold housing/shaft assembly by housing. Remove protective cap by squeezing tabs and discard. (FIG. 1)
2. Do not push on switch shaft. Detent mechanism will come apart.
3. While holding switch housing, align locating tab on base with notch on housing and engage 4 housing latches in slots on base. (FIG. 2)
4. Push firmly on housing until latches snap in place.
5. Remove clip from shaft and discard. Assembly is complete. (FIG. 3)

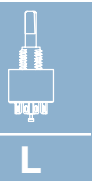
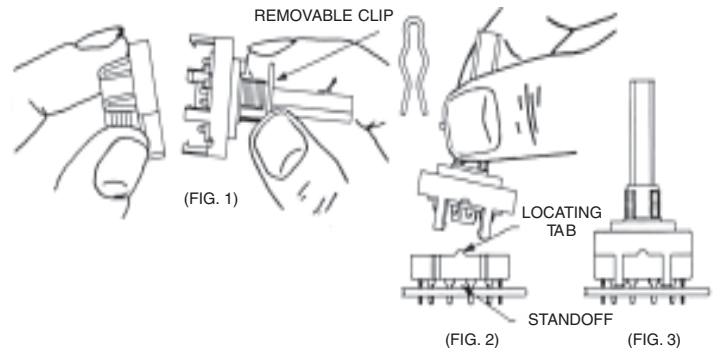

Rotary

## AVAILABLE HARDWARE

Stop ring

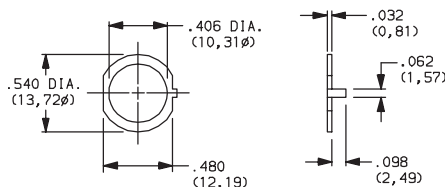

PART NO.  
**767B00201**

Material: Brass  
Finish: Nickel plated

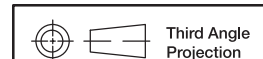

Dimensions are shown: Inch (mm)  
Specifications and dimensions subject to change

www.ittcannon.com