

MAIN FEATURES

Symbol	Value	Unit
$I_{T(RMS)}$	12	A
V_{DRM}/V_{RRM}	600 and 800	V
$I_G(Q_1)$	5 to 50	mA

DESCRIPTION

Suitable for AC switching operations, can be used as an ON/OFF function in applications such as static relays, heating regulation, induction motor starting circuits... or for phase control in light dimmers, motor speed controllers,...

The snubberless and logic level versions are specially recommended for use on inductive loads, thanks to their high commutation performances. By using an internal ceramic pad, the BTA series provides voltage insulated tab (rated at 2500V RMS) complying with UL standards.

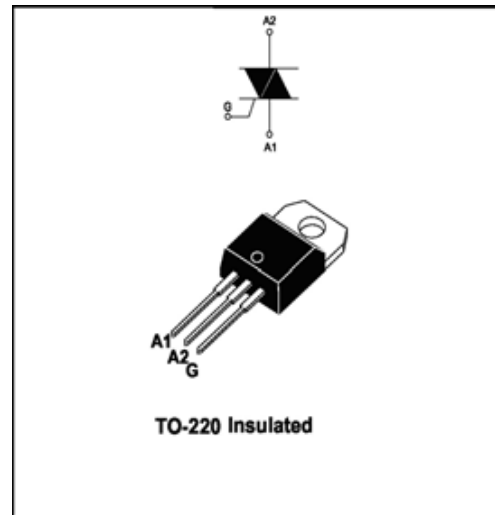
ABSOLUTE MAXIMUM RATINGS

Symbol	Parameter		Value	Unit	
$I_{T(RMS)}$	RMS on-state current (full sine wave)	$T_c = 105^\circ\text{C}$	12	A	
I_{TSM}	Non repetitive surge peak on-state current (full cycle, T_j initial = 25°C)	F = 50 Hz t = 20 ms	120	A	
		F = 60 Hz t = 16.7 ms	126		
I_t^2	I_t^2 Value for fusing	tp = 10 ms	78	A^2s	
di/dt	Critical rate of rise of on-state current $I_G = 2 \times I_{GT}$, tr ≤ 100 ns	F = 120 Hz $T_j = 125^\circ\text{C}$	50	$\text{A}/\mu\text{s}$	
I_{GM}	Peak gate current	tp = 20 μs $T_j = 125^\circ\text{C}$	4	A	
$P_{G(AV)}$	Average gate power dissipation		$T_j = 125^\circ\text{C}$	1	W
T_{stg} T_j	Storage junction temperature range Operating junction temperature range		- 40 to + 150 - 40 to + 125	$^\circ\text{C}$	

ELECTRICAL CHARACTERISTICS ($T_j = 25^\circ\text{C}$, unless otherwise specified) _n
SNUBBERLESS™ and LOGIC LEVEL (3 Quadrants)

Symbol	Test Conditions	Quadrant		Value				Unit
				TW	SW	CW	BW	
IGT (1)	$V_D = 12\text{ V}$ $R_L = 30\text{ W}$	I - II - III	MAX.	5	10	35	50	mA
VGT			MAX.			1.3		V
VGD	$V_D = V_{DRM}$ $R_L = 3.3\text{ kW}$ $T_j = 125^\circ\text{C}$	I - II - III	MIN.	0.2				V
IH (2)	$I_T = 100\text{ mA}$		MAX.	10	15	35	50	mA
IL	$I_G = 1.2\text{ IGT}$	I - III	MAX.	10	25	50	70	mA
		II		15	30	60	80	
dV/dt (2)	$V_D = 67\% V_{DRM}$ gate open $T_j = 125^\circ\text{C}$		MIN.	20	40	500	1000	V/ μs
(dI/dt) _c (2)	$(dV/dt)_c = 0.1\text{ V}/\mu\text{s}$ $T_j = 125^\circ\text{C}$		MIN.	3.5	6.5	-	-	A/ms
	$(dV/dt)_c = 10\text{ V}/\mu\text{s}$ $T_j = 125^\circ\text{C}$			1.0	2.9	-	-	
	Without snubber $T_j = 125^\circ\text{C}$			-	-	6.5	12	

_nSTANDARD (4 Quadrants)

Symbol	Test Conditions	Quadrant		Value		Unit
				C	B	
IG (1)	$V_D = 12\text{ V}$ $R_L = 30\text{ W}$	I - II - III IV	MAX.	25 50	50 100	mA
VGT			MAX.	1.3		V
VGD	$V_D = V_{DRM}$ $R_L = 3.3\text{ kW}$ $T_j = 125^\circ\text{C}$	ALL	MIN.	0.2		V
IH (2)	$I_T = 500\text{ mA}$		MAX.	25	50	mA
IL	$I_G = 1.2\text{ IGT}$	I - III - IV	MAX.	40	50	mA
		II		80	100	
dV/dt (2)	$V_D = 67\% V_{DRM}$ gate open $T_j = 125^\circ\text{C}$		MIN.	200	400	V/ μs
(dI/dt) _c (2)	$(dI/dt)_c = 2.7\text{ A/ms}$ $T_j = 125^\circ\text{C}$		MIN.	5	10	V/ μs

STATIC CHARACTERISTICS

Symbol	Test Conditions		Value	Unit	
V_T (2)	$I_{TM} = 5.5\text{ A}$ $t_p = 380\text{ }\mu\text{s}$	$T_j = 25^\circ\text{C}$	MAX.	1.55	V
V_{to} (2)	Threshold voltage	$T_j = 125^\circ\text{C}$	MAX.	0.85	V
R_d (2)	Dynamic resistance	$T_j = 125^\circ\text{C}$	MAX.	35	mW
IDRM IRRM	$V_{DRM} = V_{RRM}$	$T_j = 25^\circ\text{C}$	MAX.	5	μA
		$T_j = 125^\circ\text{C}$		1	mA

Note 1: minimum IGT is guaranteed at 5% of IGT max.

Note 2: for both polarities of A2 referenced to A1

THERMAL RESISTANCES

Symbol	Parameter	Value	Unit
$R_{th(j-c)}$	Junction to case (AC)	2.3	$^\circ\text{C}/\text{W}$
$R_{th(j-a)}$	Junction to ambient	60	$^\circ\text{C}/\text{W}$

Fig. 1: Maximum power dissipation versus RMS on-state current (full cycle).

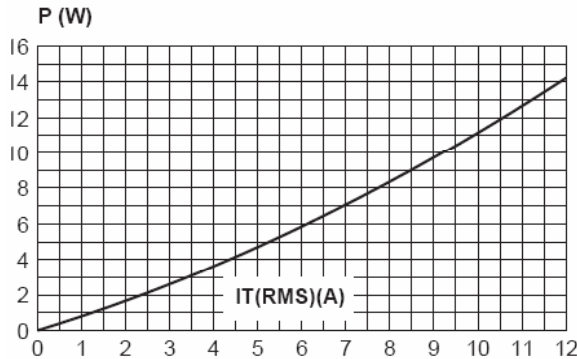

Fig. 2-1: RMS on-state current versus case temperature (full cycle).

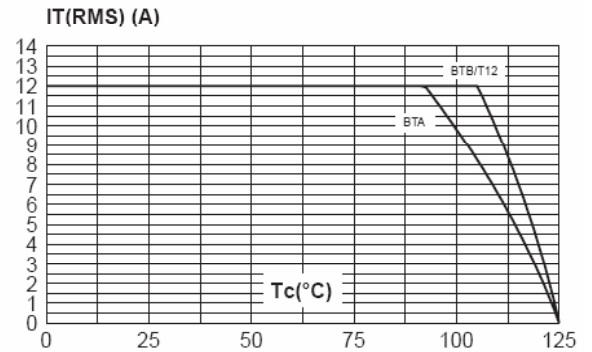

Fig. 2-2: RMS on-state current versus ambient temperature (printed circuit board FR4, copper thickness: 35µm), full cycle.

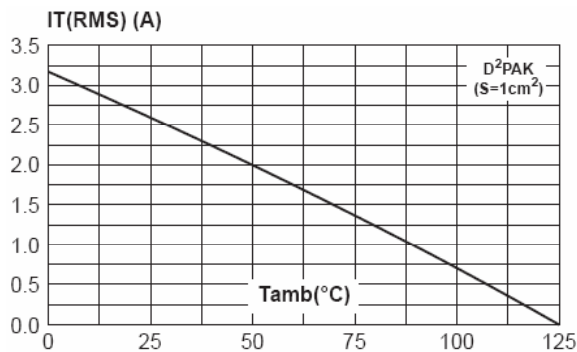

Fig. 3: Relative variation of thermal impedance versus pulse duration.

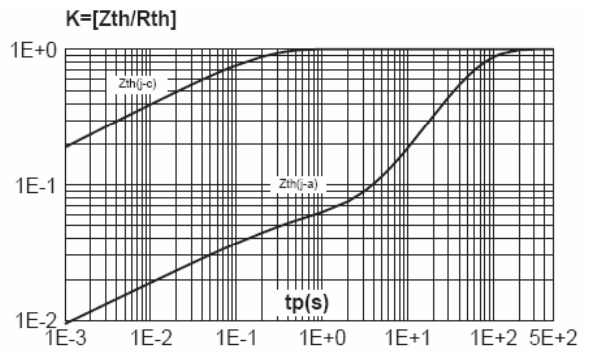

Fig. 4: On-state characteristics (maximum values).

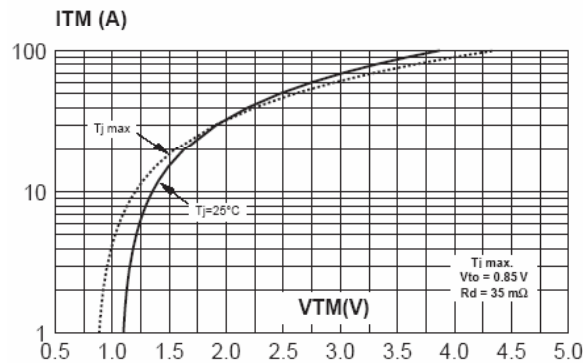

Fig. 5: Surge peak on-state current versus number of cycles.

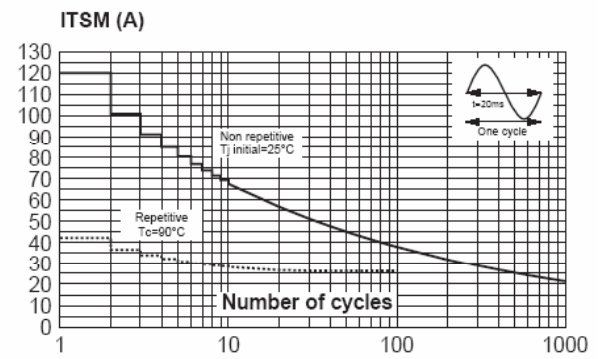

Fig. 6: Non-repetitive surge peak on-state current for a sinusoidal pulse with width $t_p < 10\text{ms}$, and corresponding value of I^2t .

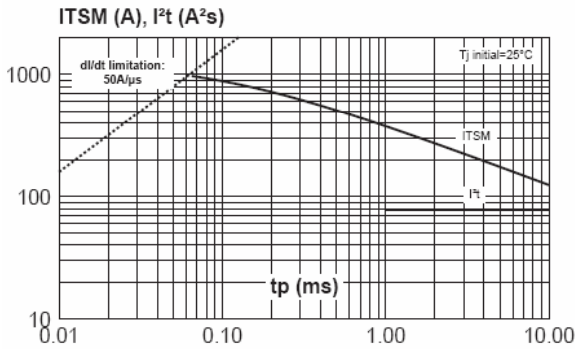

Fig. 8-1: Relative variation of critical rate of decrease of main current versus $(dV/dt)_c$ (typical values) (BW/CW/T1235).

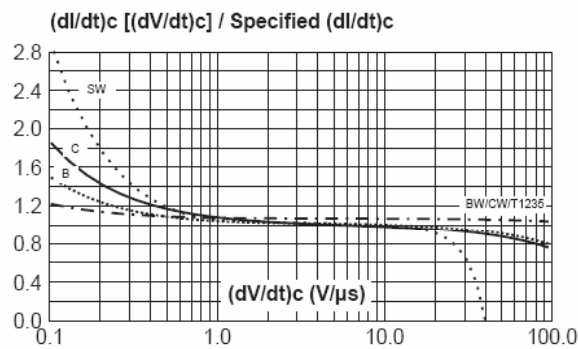

Fig. 9: Relative variation of critical rate of decrease of main current versus junction temperature.

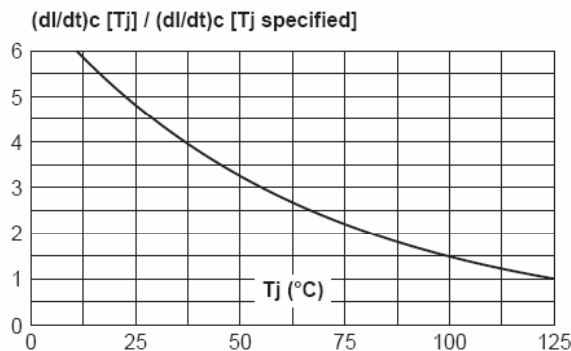

Fig. 7: Relative variation of gate trigger current, holding current and latching current versus junction temperature (typical values).

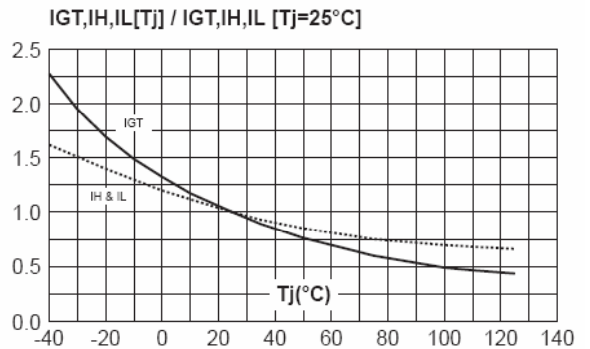

Fig. 8-2: Relative variation of critical rate of decrease of main current versus $(dV/dt)_c$ (typical values) (TW).

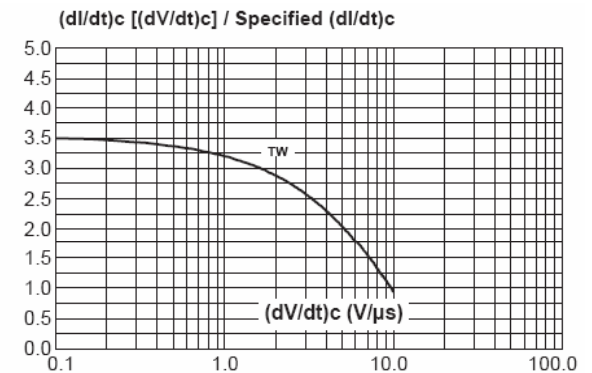
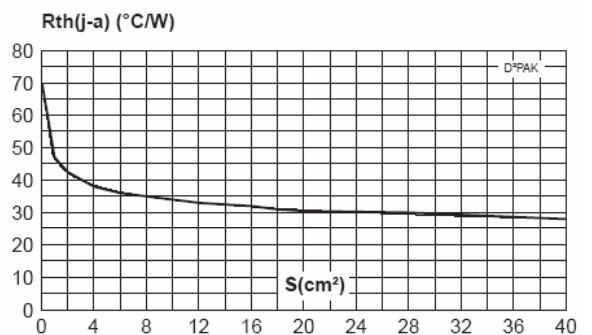
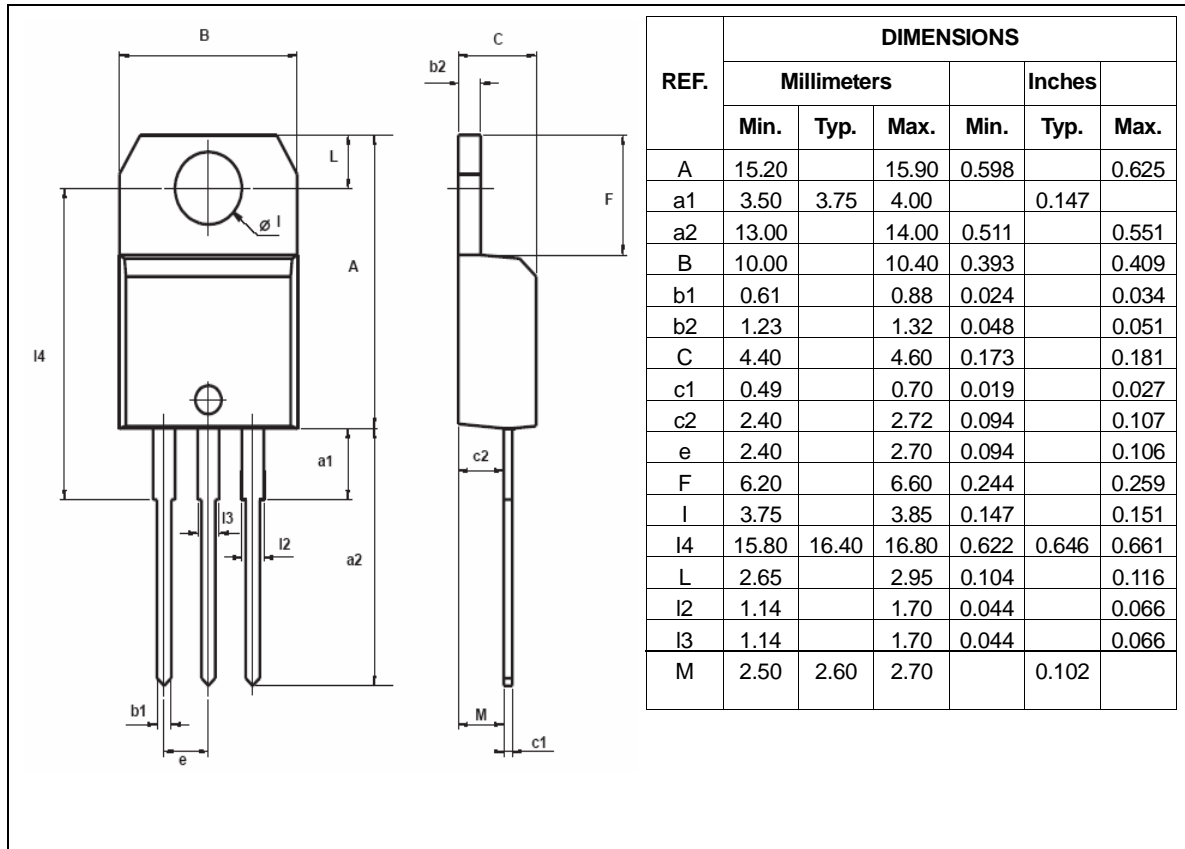

Fig. 10: D²PAK Thermal resistance junction to ambient versus copper surface under tab (printed circuit board FR4, copper thickness: 35 μm).



PACKAGE MECHANICAL DATA



REF.	DIMENSIONS					
	Millimeters			Inches		
	Min.	Typ.	Max.	Min.	Typ.	Max.
A	15.20		15.90	0.598		0.625
a1	3.50	3.75	4.00		0.147	
a2	13.00		14.00	0.511		0.551
B	10.00		10.40	0.393		0.409
b1	0.61		0.88	0.024		0.034
b2	1.23		1.32	0.048		0.051
C	4.40		4.60	0.173		0.181
c1	0.49		0.70	0.019		0.027
c2	2.40		2.72	0.094		0.107
e	2.40		2.70	0.094		0.106
F	6.20		6.60	0.244		0.259
I	3.75		3.85	0.147		0.151
I4	15.80	16.40	16.80	0.622	0.646	0.661
L	2.65		2.95	0.104		0.116
I2	1.14		1.70	0.044		0.066
I3	1.14		1.70	0.044		0.066
M	2.50	2.60	2.70		0.102	