

Cascadable Silicon Bipolar MMIC Amplifier

Technical Data

MSA-0185

Features

- **Cascadable 50 Ω Gain Block**
- **3 dB Bandwidth:**
DC to 1.0 GHz
- **High Gain:**
17.5 dB Typical at 0.5 GHz
- **Unconditionally Stable**
($k > 1$)
- **Low Cost Plastic Package**

Description

The MSA-0185 is a high performance silicon bipolar Monolithic Microwave Integrated Circuit (MMIC) housed in a low cost plastic package. This MMIC is

designed for use as a general purpose 50 Ω gain block. Typical applications include narrow and broad band IF and RF amplifiers in industrial and military applications.

The MSA-series is fabricated using HP's 10 GHz f_T , 25 GHz f_{MAX} , silicon bipolar MMIC process which uses nitride self-alignment, ion implantation, and gold metallization to achieve excellent performance, uniformity and reliability. The use of an external bias resistor for temperature and current stability also allows bias flexibility.

85 Plastic Package

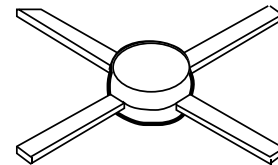

Typical Biasing Configuration

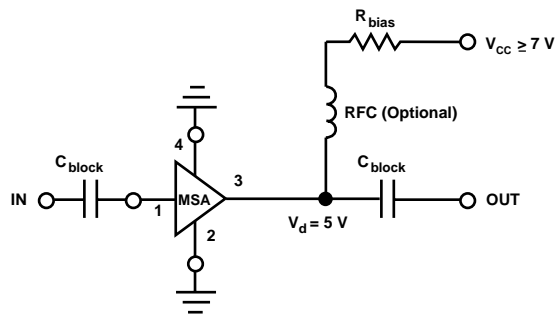

MSA-0185 Absolute Maximum Ratings

Parameter	Absolute Maximum ^[1]
Device Current	40 mA
Power Dissipation ^[2,3]	200 mW
RF Input Power	+13 dBm
Junction Temperature	150°C
Storage Temperature	-65 to 150°C

Thermal Resistance^[2,4]:

$$\theta_{jc} = 105^{\circ}\text{C/W}$$

Notes:

1. Permanent damage may occur if any of these limits are exceeded.
2. $T_{\text{CASE}} = 25^{\circ}\text{C}$.
3. Derate at $9.5 \text{ mW}/^{\circ}\text{C}$ for $T_{\text{C}} > 129^{\circ}\text{C}$.
4. See MEASUREMENTS section “Thermal Resistance” for more information.

MSA-0185 Electrical Specifications^[1], $T_{\text{A}} = 25^{\circ}\text{C}$

Symbol	Parameters and Test Conditions: $I_{\text{d}} = 17 \text{ mA}$, $Z_{\text{o}} = 50 \Omega$	Units	Min.	Typ.	Max.
G_{P}	Power Gain ($ S_{21} ^2$) $f = 0.1 \text{ GHz}$ $f = 0.5 \text{ GHz}$	dB	16.0	18.5 17.5	
ΔG_{P}	Gain Flatness $f = 0.1 \text{ to } 0.6 \text{ GHz}$	dB		± 0.6	
$f_{3 \text{ dB}}$	3 dB Bandwidth	GHz		1.0	
VSWR	Input VSWR $f = 0.1 \text{ to } 3.0 \text{ GHz}$			1.3:1	
	Output VSWR $f = 0.1 \text{ to } 3.0 \text{ GHz}$			1.3:1	
NF	50 Ω Noise Figure $f = 0.5 \text{ GHz}$	dB		5.5	
$P_{1 \text{ dB}}$	Output Power at 1 dB Gain Compression $f = 0.5 \text{ GHz}$	dBm		1.5	
IP_3	Third Order Intercept Point $f = 0.5 \text{ GHz}$	dBm		14.0	
t_{D}	Group Delay $f = 0.5 \text{ GHz}$	psec		150	
V_{d}	Device Voltage	V	4.0	5.0	6.0
dV/dT	Device Voltage Temperature Coefficient	mV/ $^{\circ}\text{C}$		-9.0	

Note:

1. The recommended operating current range for this device is 13 to 25 mA. Typical performance as a function of current is on the following page.

MSA-0185 Typical Scattering Parameters ($Z_0 = 50 \Omega$, $T_A = 25^\circ\text{C}$, $I_d = 17 \text{ mA}$)

Freq. GHz	S_{11}		S_{21}			S_{12}			S_{22}	
	Mag	Ang	dB	Mag	Ang	dB	Mag	Ang	Mag	Ang
0.1	.06	166	18.4	8.36	172	-22.6	.074	3	.07	-17
0.2	.06	149	18.3	8.20	165	-22.0	.079	8	.07	-28
0.3	.06	133	18.1	8.01	158	-22.2	.078	11	.08	-43
0.4	.06	120	17.8	7.78	151	-21.9	.080	14	.09	-56
0.5	.06	105	17.5	7.53	144	-21.4	.085	18	.09	-68
0.6	.06	94	17.2	7.23	138	-21.4	.085	19	.09	-75
0.8	.07	72	16.5	6.66	127	-20.7	.092	24	.10	-89
1.0	.07	49	15.7	6.09	116	-19.7	.104	27	.10	-100
1.5	.07	12	13.8	4.89	94	-18.0	.126	32	.11	-120
2.0	.04	-13	12.0	3.98	76	-16.2	.154	31	.11	-134
2.5	.03	-84	10.6	3.38	65	-15.1	.175	33	.11	-138
3.0	.07	-159	9.2	2.88	52	-14.2	.194	29	.09	-146
3.5	.12	-174	8.0	2.50	38	-13.3	.216	24	.08	-135
4.0	.16	170	6.8	2.19	26	-12.8	.229	19	.08	-120
4.5	.21	150	5.7	1.93	14	-12.3	.242	13	.08	-107
5.0	.25	126	4.7	1.72	3	-12.2	.245	-6	.07	-110

A model for this device is available in the DEVICE MODELS section.

MSA-0185 Typical Performance, $T_A = 25^\circ\text{C}$

(unless otherwise noted)

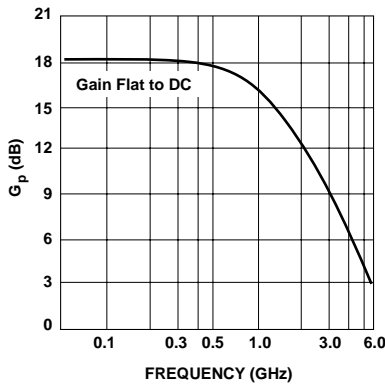

Figure 1. Typical Power Gain vs. Frequency, $T_A = 25^\circ\text{C}$, $I_d = 17 \text{ mA}$.

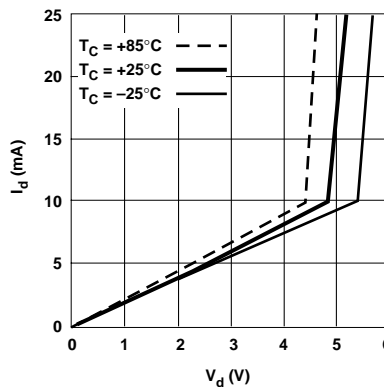

Figure 2. Device Current vs. Voltage.

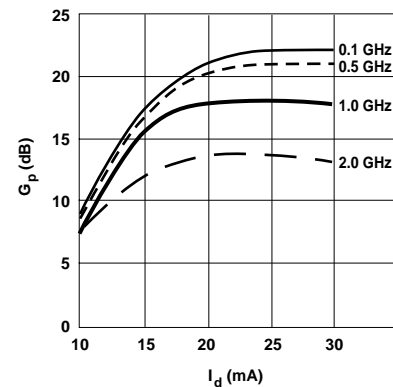

Figure 3. Power Gain vs. Current.

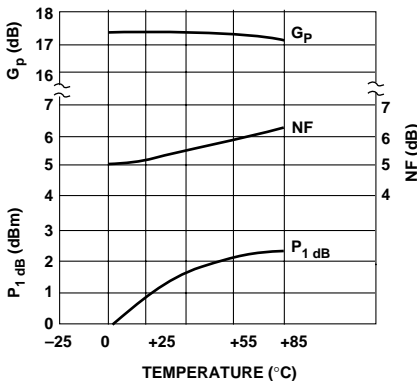

Figure 4. Output Power at 1 dB Gain Compression, NF and Power Gain vs. Case Temperature, $f = 0.5 \text{ GHz}$, $I_d = 17 \text{ mA}$.

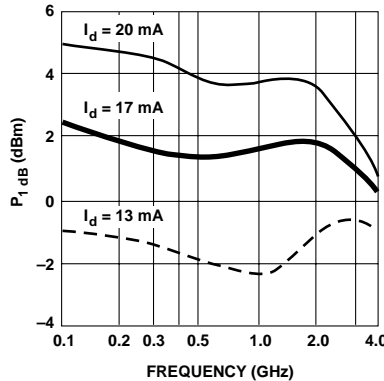

Figure 5. Output Power at 1 dB Gain Compression vs. Frequency.

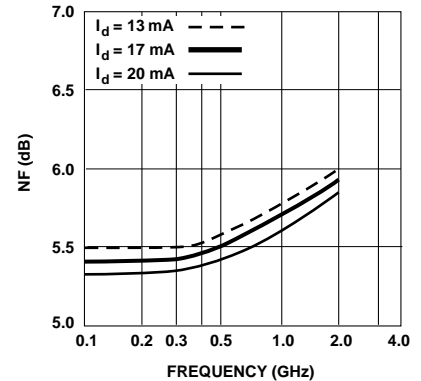

Figure 6. Noise Figure vs. Frequency.

85 Plastic Package Dimensions

