



LINEAR INTEGRATED CIRCUITS

NOT FOR NEW DESIGN

AM-FM RADIO

The TDA 1220A is a monolithic integrated circuit in a 16-lead dual in-line plastic package designed for use in portable and home AM-FM radio sets.

The functions incorporated are:

AM SECTION

- Preamplifier and double balanced mixer
- Local oscillator
- IF amplifier with internal AGC
- Balanced detector
- AF preamplifier

FM SECTION

- IF amplifier
- Quadrature detector
- AF preamplifier

The TDA 1220A is suitable for all AM and FM broadcasting bands and it features:

- Very low noise
- High sensitivity
- Wide supply voltage range (3 to 16V)
- Low quiescent current (9 mA)
- Very simple DC switching of AM-FM sections

ABSOLUTE MAXIMUM RATINGS

V_s	Supply voltage	16	V
P_{tot}	Total power dissipation at $T_{amb} \leq 110^\circ\text{C}$	400	mW
T_{op}	Operating temperature	-20 to 85	$^\circ\text{C}$
T_{stg}, T_j	Storage and junction temperature	-55 to 150	$^\circ\text{C}$

ORDERING NUMBER: TDA 1220A

MECHANICAL DATA

Dimensions in mm

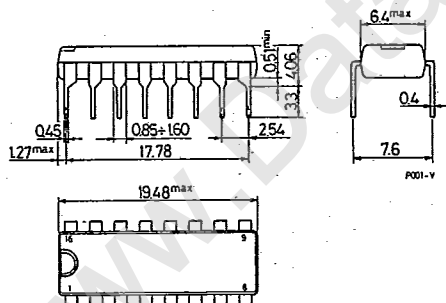

1097

A-14

385

11/83

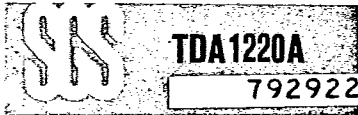

TDA1220A

7929225 S G S SEMICONDUCTOR CORP

CONNECTION DIAGRAM (top view)

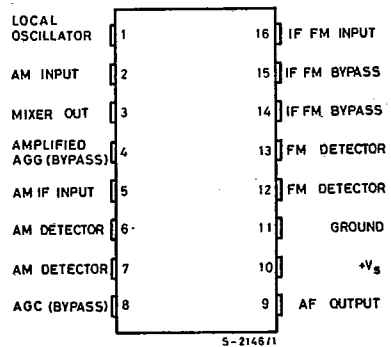

BLOCK DIAGRAM

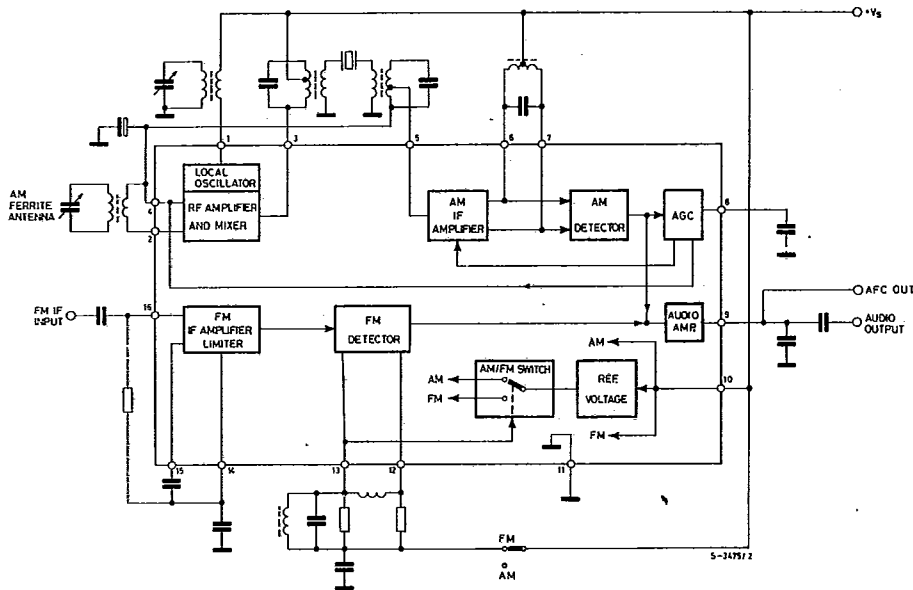

THERMAL DATA

R _{th j-amb} Thermal resistance junction-ambient	max 100 °C/W
---	--------------

1098

B-01

386

ELECTRICAL CHARACTERISTICS ($T_{amb} = 25^{\circ}\text{C}$, $V_s = 9\text{V}$ unless otherwise specified, refer to test circuit)

Parameter	Test condition	Min.	Typ.	Max.	Unit
-----------	----------------	------	------	------	------

DC CHARACTERISTICS

V_s	Supply Voltage		3		16	V
I_d	Drain current	AM section		9	15	mA
		FM section		9	15	

AC CHARACTERISTICS

AM SECTION ($f_o = 1\text{ MHz}$; $f_m = 1\text{ kHz}$)							
V_i	Input sensitivity	$S/N = 26\text{ dB}$	$m = 0.3$		12	25	μV
S/N	Ultimate quieting	$V_i = 10\text{ mV}$	$m = 0.3$	50	60		dB
ΔV_i	AGC range	$\Delta V_{out} = 10\text{ dB}$	$m = 0.3$	80			dB
V_o	Recovered audio signal (pin 9)	$V_i = 1\text{ mV}$	$m = 0.3$	40	80	160	mV
d	Distortion	$V_i = 1\text{ mV}$	$m = 0.8$		1	3	%
d	Distortion	$V_i = 1\text{ mV}$	$m = 0.3$		0.4	1	%
V_{IH}	Max input signal handling capability	$m = 0.8$	$d = 10\%$		80		mV
R_i	Input resistance between pins 2 and 4	$m = 0$			7.5		$\text{K}\Omega$
C_i	Input capacitance between pins 2 and 4	$m = 0$			18		pF
R_o	Output resistance (pin 9)				7		$\text{K}\Omega$
FM SECTION ($f_o = 10.7\text{ MHz}$; $f_m = 1\text{ kHz}$)							
V_i	Input limiting voltage	-3 dB limiting point				36	μV
AMR	Amplitude modulation rejection	$\Delta f = \pm 22.5\text{ KHz}$ $V_i = 3\text{ mV}$		35	48		dB
S/N	Ultimate quieting	$\Delta f = \pm 22.5\text{ KHz}$	$V_i = 1\text{ mV}$	55	70		dB
d	Distortion (single tuned)	$\Delta f = \pm 75\text{ KHz}$	$V_i = 1\text{ mV}$		0.7	3	%
d	Distortion (double tuned)	$\Delta f = \pm 22.5\text{ KHz}$	$V_i = 1\text{ mV}$		0.2		
V_o	Recovered audio signal (pin 9)	$\Delta f = \pm 22.5\text{ KHz}$	$V_i = 1\text{ mV}$	40	80	160	mV
R_i	Input resistance between pin 16 and ground	$\Delta f = 0$			6.5		$\text{K}\Omega$
C_i	Input capacitance between pin 16 and ground	$\Delta f = 0$			14		pF
R_o	Output resistance (pin 9)				7		$\text{K}\Omega$



TEST CIRCUIT

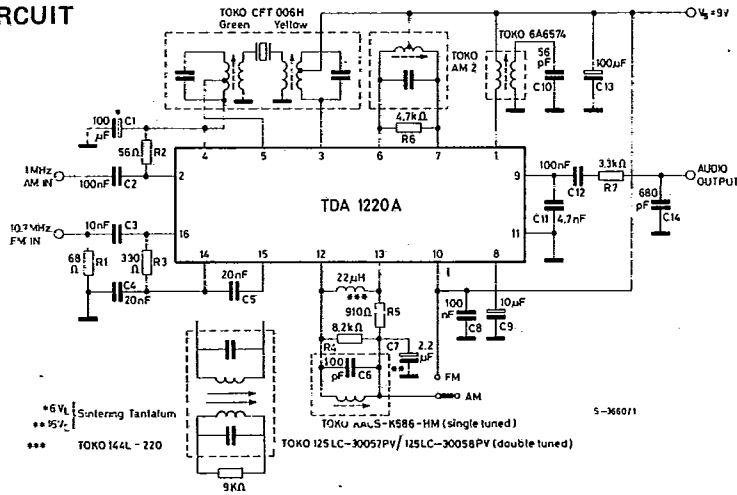
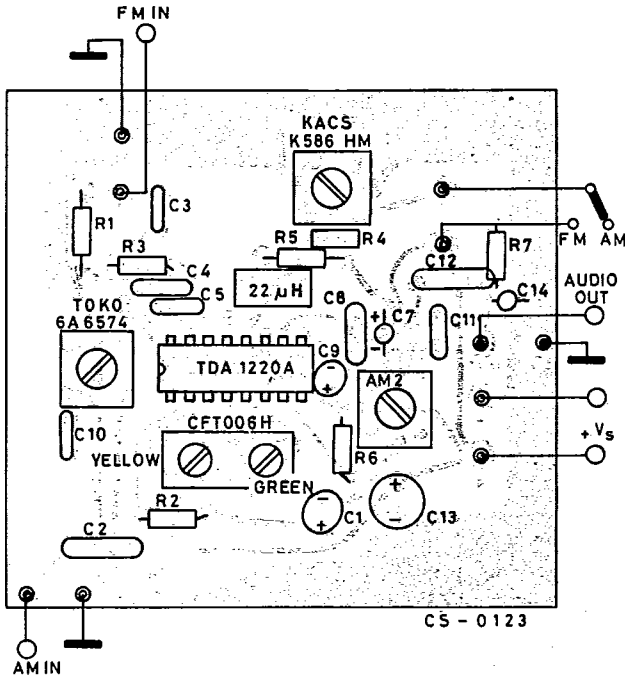

Fig. 1 - PC board and component layout (1 : 1 scale) of the test circuit



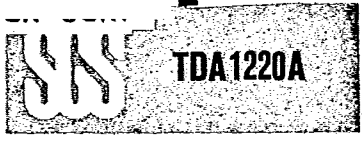

Fig. 2 - Audio output and signal to noise ratio vs. input signal (AM section)

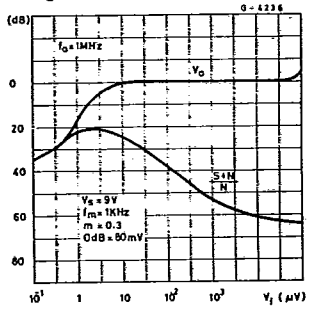

Fig. 3 - Audio output vs. supply voltage (AM section)

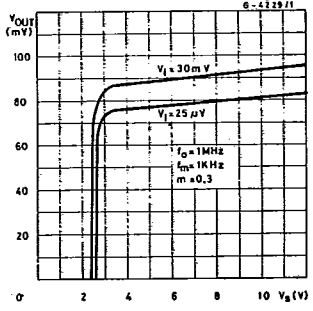

Fig. 4 - Distortion vs. input signal (AM section)

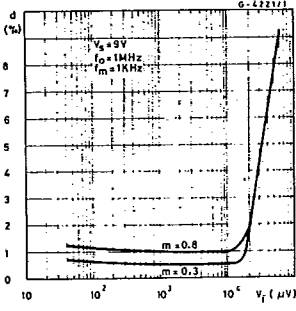

Fig. 5 - Audio output and signal to noise ratio vs. input signal (FM section)

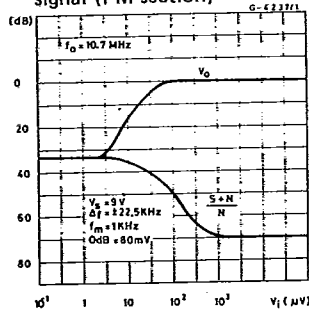

Fig. 6 - Audio output vs. supply voltage (FM section)

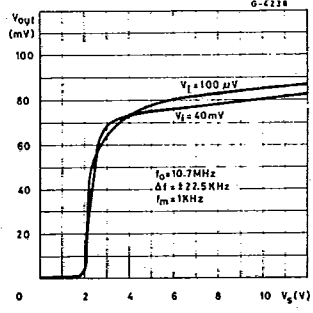

Fig. 7 - Amplitude modulation rejection vs. input signal (FM section)

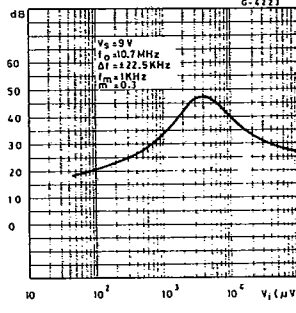

Fig. 8 - Δ DC voltage (pin 9) vs. ambient temperature (FM section)

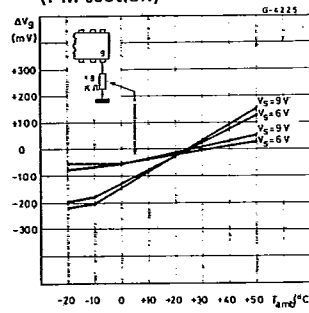

Fig. 9 - DC output voltage (pin 9) vs. supply voltage (FM section)

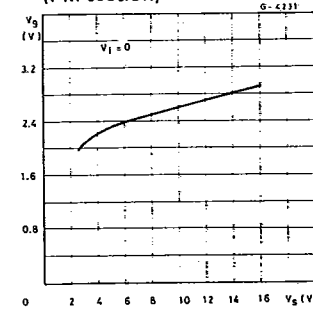
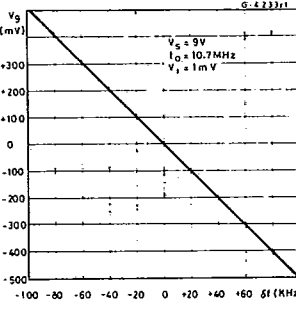

Fig. 10 - Δ DC output voltage (pin 9) vs. frequency shift (FM section)



TDA1220A

7929225 S G S SEMICONDUCTOR CORP

APPLICATION INFORMATION

FM Section

IF Amplifier and limiter

The 10.7 MHz IF signal from the ceramic filter is amplified and limited by a chain of four differential stages.

Pin 16 is the amplifier input and has a typical input impedance of $6.5\text{ K}\Omega$ in parallel with 14 pF at 10.7 MHz.

Bias for the first stage is available at pin 14 and provides 100% DC feedback for stable operating conditions. Pin 15 is the second input to the amplifier and is decoupled to pin 14, which is grounded by a 20 nF capacitor.

An RLC network is connected to the amplifier output and gives a 90° phase shift (at the IF centre frequency) between pins 13 and 12. The signal level at pin 13 is about 150 mV rms .

FM Detector

The circuit uses a quadrature detector and the choice of component values is determined by the acceptable level of distortion at a given recovered audio level.

With a double tuned network the linearity improves (distortion is reduced) and the phase shift can be optimized; however this leads to a reduction in the level of the recovered audio. A satisfactory compromise for most FM receiver applications is shown in the test circuit.

Care should be taken with the physical layout.

The main recommendations are:

- Locate the phase shift coil as near as possible to pin 13.
- Shunt pins 14 and 16 with a low value resistor (between 56Ω and 330Ω).
- Ground the decoupling capacitor of pin 14 and the 10.7 MHz input filter at the same point.

If the supply voltage goes under 6V add a DC level shift resistor of $18\text{ K}\Omega$ from pin 9 to ground and change C11 to 8 nF .

AM-FM Switching

AM-FM switching is achieved by applying a DC voltage at pin 13, to switch the internal reference.

Typical DC Voltages (refer to the test circuit)

Pins	1	2	3	4	5	6	7	8	9	10	11	12	13	14	15	16	Unit
AM	9	1.3	9	1.3	1.3	9	9	0.7	2	9	0	0	0	8.4	8.4	8.4	V
FM	9	0.4	9	0.4	0	9	9	0	2.6	9	0	9	9	8.1	8.1	8.1	V

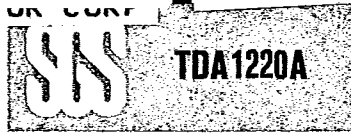

APPLICATION INFORMATION (continued)**AM Section****RF Amplifier and mixer stages**

The RF amplifier stage (pin 2) is connected directly to the secondary winding of the ferrite rod antenna or input tuned circuit. Bias is provided at pin 4 which must be adequately decoupled. The RF amplifier provides stable performance extending beyond 30 MHz.

The Mixer employed is a double - balanced multiplier and the IF output at pin 3 is connected directly to the IF filter coil.

Local oscillator

The local oscillator is a cross coupled differential stage which oscillates as the frequency determined by the load on pin 1.

The oscillator resonant circuit is transformer coupled to pin 1 to improve the Q factor and frequency stability.

The oscillator level at pin 1 is about 100 mV rms and the performance extends beyond 30 MHz, however to enhance the stability and reduce to a minimum pulling effects of the AGC operation or supply voltage variations, a high C/L ratio should be used above 10 MHz.

An external oscillator can be injected at pin 1. The level should be 50 mV rms and pin 1 should be connected to the supply via a 100 Ω resistor.

IF Amplifier Detector

The IF amplifier is a wide band amplifier with a tuned output stage.

The outputs are at pins 6 and 7 which drive the balanced load and the differential positive peak AM detector, which is biased to reduce distortion at high modulation levels. At the output of balanced detectors of this type there is a low level signal at double the IF frequency (about 920 KHz). To avoid feedback of this signal by radiation from the detector coil, the shield around this coil must be grounded and the ferrite antenna placed in a suitable position.

The Audio output is at pin 9 (for either AM or FM); the IF frequency is filtered by an external capacitor which is also used as the FM mono de-emphasis network. The audio output impedance is about 7 K Ω and a high impedance load (\sim 50 K Ω) must be used.

AGC

Both the RF and the first IF amplifiers have the same differential amplifier circuit configuration. The AGC action is obtained by control of the collector current of these stages.

At pin 8 there is a carrier envelope signal which is filtered by an external capacitor to remove the Audio and RF content and obtain a mean DC signal to drive the AGC circuit.

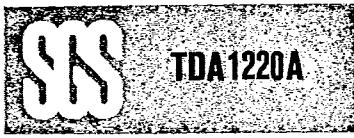

7929225 S G S SEMICONDUCTOR CORP.

APPLICATION INFORMATION (continued)

Fig. 12 - PC board and component layout of the four band radio (fig. 11)

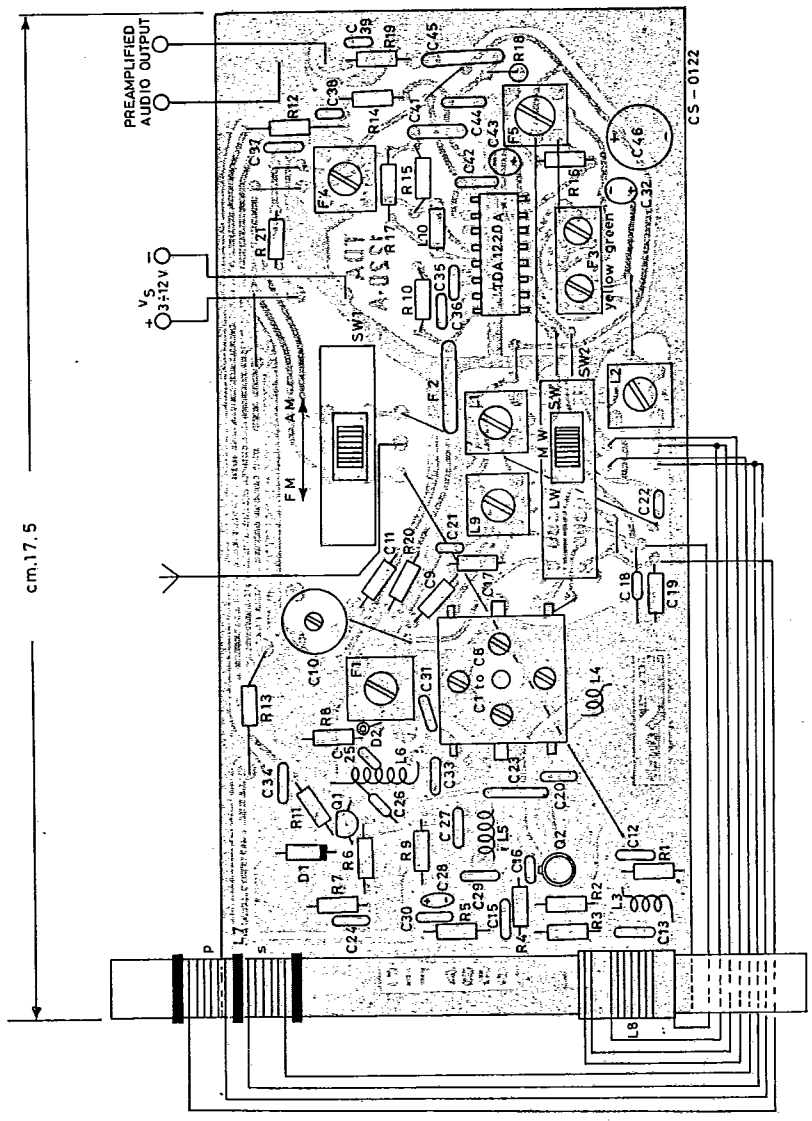

TDA1220A

APPLICATION INFORMATION (continued)

FOUR BAND RADIO PERFORMANCE

Parameter	Test conditions	Values
AM SECTION (*)		
$\left \frac{S+N}{N} \right $	$V_i = 10 \mu V$ $m = 0.3$	26 dB
	$V_i = 1 mV$ $m = 0.3$	55 dB
BW	-3 dB	10 KHz
Distortion	$V_i = 20 \mu V$ $m = 0.3$	0.5 %
	$V_i = 100 \mu V$ $m = 0.3$	0.5 %
	$V_i = 1 mV$ $m = 0.3$	0.5 %
	$V_i = 20 \mu V$ $m = 0.8$	0.9 %
	$V_i = 1 mV$ $m = 0.8$	1 %

FM SECTION

AMR	$V_i = 30 \mu V$ $\Delta f = 22.5 KHz$ $m = 0.3$ $f_m = 1 KHz$	45 dB
	$V_i = 100 \mu V$ $\Delta f = 22.5 KHz$ $m = 0.3$ $f_m = 1 KHz$	47 dB
Distortion	$V_i = 10 \mu V$ $\Delta f = 22.5 KHz$	0.3 %
	$V_i = 100 \mu V$ $\Delta f = 22.5 KHz$	0.2 %
	$V_i = 1 mV$ $\Delta f = 22.5 KHz$	0.2 %
	$V_i = 10 \mu V$ $\Delta f = 75 KHz$	1 %
	$V_i = 100 \mu V$ $\Delta f = 75 KHz$	1 %
	$V_i = 1 mV$ $\Delta f = 22.5 KHz$	70 dB
$\left \frac{S+N}{N} \right $	$V_i = 10 \mu V$ $\Delta f = 22.5 KHz$	60 dB
	$V_i = 100 \mu V$ $\Delta f = 22.5 KHz$	70 dB
	$V_i = 1 mV$ $\Delta f = 22.5 KHz$	70 dB
Input limiting voltage	-3 dB	1 μV

(*) The performance remains substantially the same over LW, MW and SW bands.

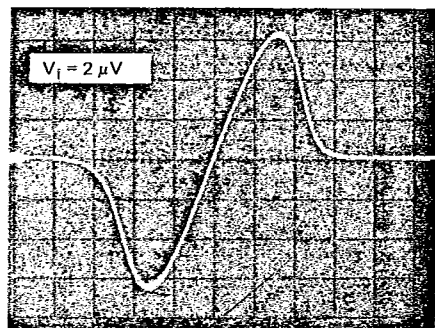

100 KHz/div.
Fig. 13 - FM-SECTION
S curve response

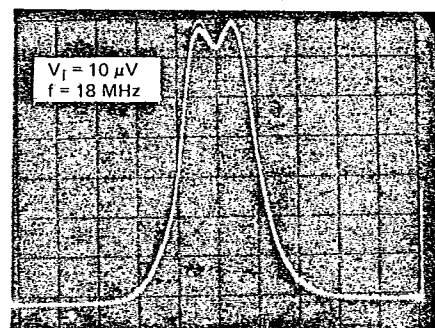

5 KHz/div.
Fig. 14 - AM-SECTION
Band pass IF filter response at AGC starting point.