

NPN Silicon RF Transistor

BFQ 74

- For low-noise amplifiers in the GHz range, and broadband analog and digital applications in telecommunications systems at collector currents from 1 mA to 25 mA.
- Hermetically sealed ceramic package.
- HiRel/Mil screening available.

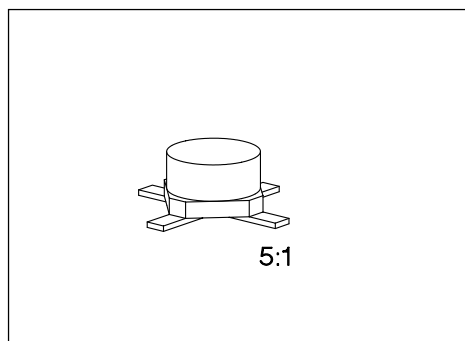

ESD: Electrostatic discharge sensitive device, observe handling precautions!

Type	Marking	Ordering Code (tape and reel)	Pin Configuration				Package ¹⁾
			1	2	3	4	
BFQ 74	74	Q62702-F788	B	E	C	E	Cerrec-X

Maximum Ratings

Parameter	Symbol	Values	Unit
Collector-emitter voltage	V_{CE0}	16	V
Collector-emitter voltage, $V_{BE} = 0$	V_{CES}	25	
Collector-base voltage	V_{CB0}	25	
Emitter-base voltage	V_{EB0}	2	
Collector current	I_C	35	mA
Peak collector current, $f \geq 10$ MHz	I_{CM}	45	
Base current	I_B	5	
Total power dissipation, $T_S \leq 115$ °C ³⁾	P_{tot}	300	mW
Junction temperature	T_j	175	°C
Ambient temperature range	T_A	- 65 ... + 175	
Storage temperature range	T_{stg}	- 65 ... + 175	

Thermal Resistance

Junction - ambient ²⁾	$R_{th JA}$	≤ 280	K/W
Junction - soldering point ³⁾	$R_{th JS}$	≤ 200	

1) For detailed dimensions see chapter Package Outlines.

2) Package mounted on alumina 15 mm × 16.7 mm × 0.7 mm.

3) T_S is measured on the collector lead at the soldering point to the pcb.

Electrical Characteristics

at $T_A = 25\text{ °C}$, unless otherwise specified.

Parameter	Symbol	Values			Unit
		min.	typ.	max.	

DC Characteristics

Collector-emitter breakdown voltage $I_C = 1\text{ mA}, I_B = 0$	$V_{(BR)CE0}$	16	–	–	V
Collector-emitter cutoff current $V_{CE} = 25\text{ V}, V_{BE} = 0$	I_{CES}	–	–	100	μA
Collector-base cutoff current $V_{CB} = 15\text{ V}, I_E = 0$	I_{CBO}	–	–	50	nA
Emitter-base cutoff current $V_{EB} = 2\text{ V}, I_C = 0$	I_{EBO}	–	–	10	μA
DC current gain $I_C = 5\text{ mA}, V_{CE} = 10\text{ V}$ $I_C = 15\text{ mA}, V_{CE} = 10\text{ V}$	h_{FE}	50 50	110 120	250 –	–
Collector-emitter saturation voltage $I_C = 30\text{ mA}, I_B = 3\text{ mA}$	V_{CEsat}	–	0.13	0.3	V
Base-emitter voltage $I_C = 10\text{ mA}, V_{CE} = 10\text{ V}$	V_{BE}	–	0.78	–	

Electrical Characteristics

at $T_A = 25\text{ °C}$, unless otherwise specified.

Parameter	Symbol	Values			Unit
		min.	typ.	max.	

AC Characteristics

Transition frequency $I_C = 5\text{ mA}$, $V_{CE} = 10\text{ V}$, $f = 200\text{ MHz}$ $I_C = 15\text{ mA}$, $V_{CE} = 10\text{ V}$, $f = 200\text{ MHz}$	f_t	–	4.4 6	–	GHz
Collector-base capacitance $V_{CB} = 10\text{ V}$, $V_{BE} = v_{be} = 0$, $f = 1\text{ MHz}$	C_{cb}	–	0.3	0.4	pF
Collector-emitter capacitance $V_{CE} = 10\text{ V}$, $V_{BE} = v_{be} = 0$, $f = 1\text{ MHz}$	C_{ce}	–	0.4	–	
Input capacitance $V_{EB} = 0.5\text{ V}$, $I_C = i_c = 0$, $f = 1\text{ MHz}$	C_{ibo}	–	1.35	–	
Output capacitance $V_{CE} = 10\text{ V}$, $V_{BE} = v_{be} = 0$, $f = 1\text{ MHz}$	C_{obs}	–	0.7	–	
Noise figure $I_C = 3\text{ mA}$, $V_{CE} = 10\text{ V}$, $f = 10\text{ MHz}$, $Z_S = 75\text{ }\Omega$ $I_C = 5\text{ mA}$, $V_{CE} = 10\text{ V}$, $f = 800\text{ MHz}$, $Z_S = 50\text{ }\Omega$ $I_C = 10\text{ mA}$, $V_{CE} = 10\text{ V}$, $f = 2\text{ GHz}$, $Z_S = Z_{Sopt}$	F	–	0.9 1.4 2.5	– – 2.9	dB
Power gain $I_C = 15\text{ mA}$, $V_{CE} = 10\text{ V}$, $f = 2\text{ GHz}$, $Z_0 = 50\text{ }\Omega$ $I_C = 15\text{ mA}$, $V_{CE} = 10\text{ V}$, $f = 4\text{ GHz}$, $Z_0 = 50\text{ }\Omega$	$G_{ma}^{1)}$ $G_{rms}^{2)}$	–	14 9.8	– –	
Transducer gain $I_C = 15\text{ mA}$, $V_{CE} = 10\text{ V}$, $f = 2\text{ GHz}$, $Z_0 = 50\text{ }\Omega$	$ S_{21e} ^2$	–	9.8	–	
Linear output voltage two-tone intermodulation test $I_C = 25\text{ mA}$, $V_{CE} = 10\text{ V}$, $d_{IM} = 60\text{ dB}$, $f_1 = 806\text{ MHz}$, $f_2 = 810\text{ MHz}$, $Z_S = Z_L = 50\text{ }\Omega$	$V_{o1} = V_{o2}$	–	160	–	mV
Third order intercept point $I_C = 25\text{ mA}$, $V_{CE} = 10\text{ V}$, $f = 800\text{ MHz}$	IP_3	–	27	–	dBm

$$1) \quad \left| \frac{S_{21e}}{S_{12e}} \right| (k - \sqrt{k^2 - 1})$$

$$2) \quad \left| \frac{S_{21e}}{S_{12e}} \right|$$

Total power dissipation $P_{tot} = f(T_A^*; T_S)$

*Package mounted on alumina

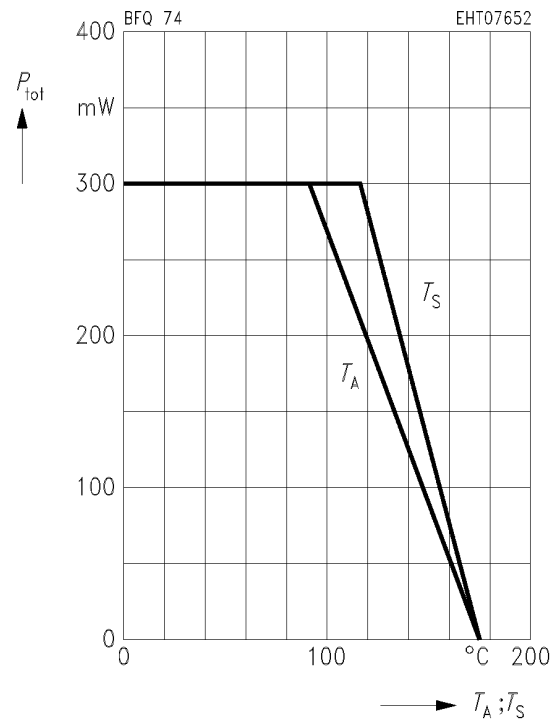

Transition frequency $f_T = f(I_C)$

$f = 200$ MHz

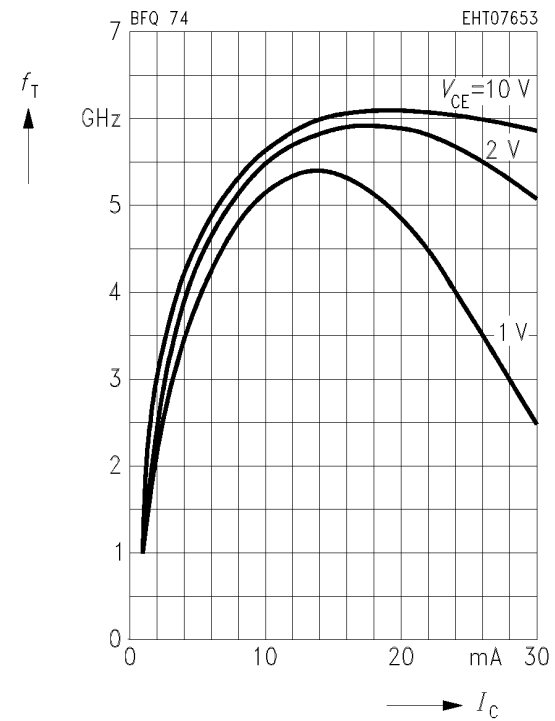

Collector-base capacitance $C_{cb} = f(V_{CB})$

$V_{BE} = v_{be} = 0, f = 1$ MHz

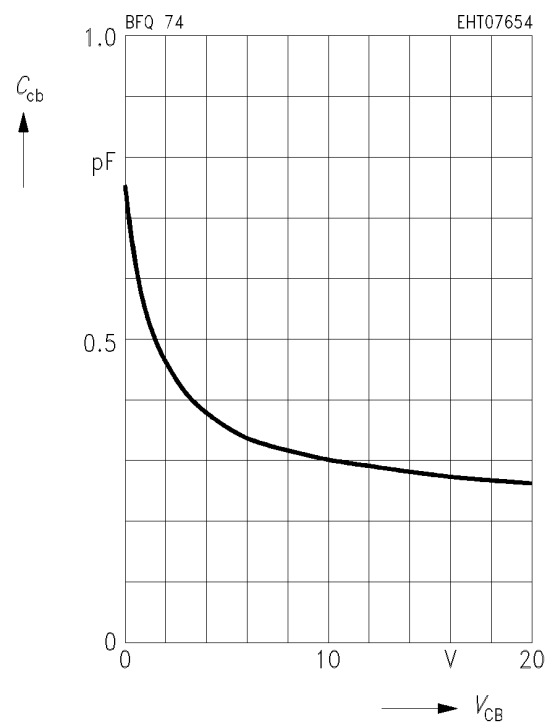

Common Emitter Noise Parameters

f	F_{min}	$G_p(F_{min})$	Γ_{opt}		R_N	N	$F_{50\Omega}$	$G_p(F_{50\Omega})$
GHz	dB	dB	MAG	ANG	Ω	-	dB	dB

$I_C = 3\text{ mA}, V_{CE} = 10\text{ V}, Z_0 = 50\ \Omega$

0.01	0.7	-	(Z _s = 150 Ω)		-	-	1.2	-
------	-----	---	----------------------------------	--	---	---	-----	---

$I_C = 10\text{ mA}, V_{CE} = 10\text{ V}, Z_0 = 50\ \Omega$

0.01	1.05	-	(Z _s = 75 Ω)		-	-	1.2	-
0.8	1.3	17.5	0.22	82	11.5	0.20	1.4	16.8
2.0	2.5	11.5	0.20	137	23.5	0.60	2.7	10

Noise figure $F = f(I_C)$

$V_{CE} = 10\text{ V}, f = 10\text{ MHz}$

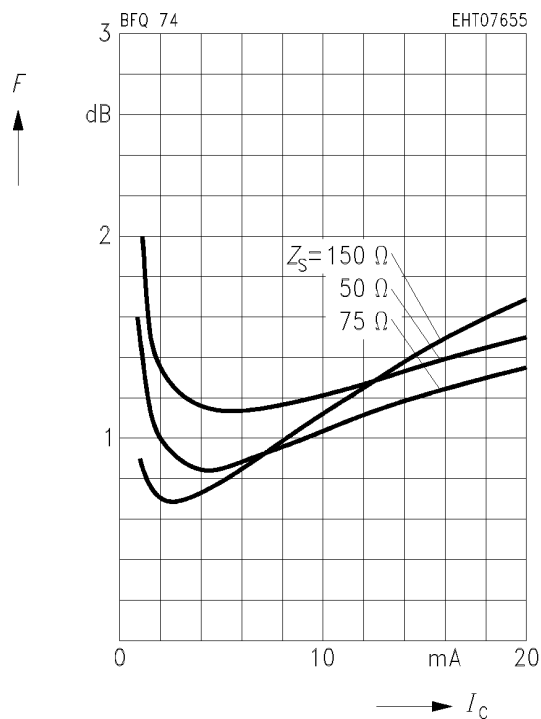

Circles of constant noise figure $F = f(Z_S)$ and available power gain $G_{av} = f(Z_S)$

$I_C = 10 \text{ mA}$, $V_{CE} = 10 \text{ V}$, $f = 800 \text{ MHz}$

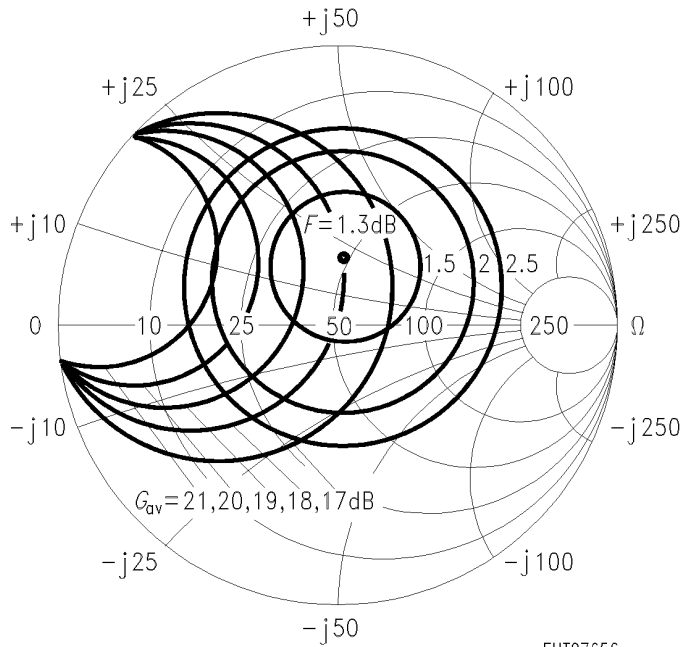

EHT07656

Noise figure $F = f(I_C)$

Power gain $G = f(I_C)$

$V_{CE} = 10 \text{ V}$, $f = 800 \text{ MHz}$, $Z_{Lopt} (G)$

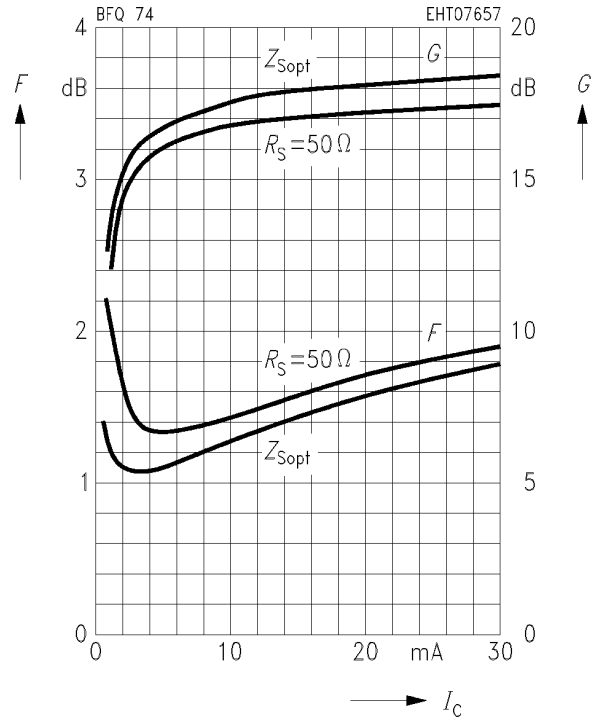

Circles of constant noise figure $F = f(Z_S)$ and available power gain $G_{av} = f(Z_S)$

$I_C = 10 \text{ mA}$, $V_{CE} = 10 \text{ V}$, $f = 2 \text{ GHz}$

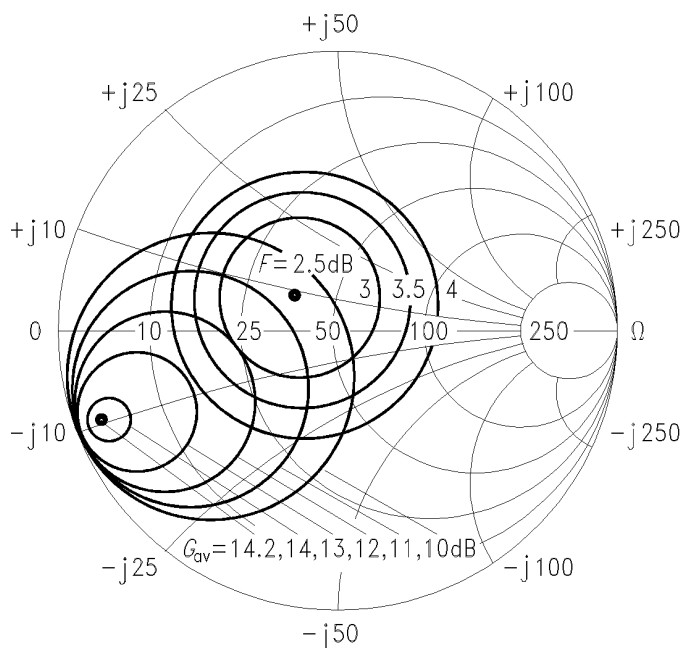

EHT07658

Noise figure $F = f(I_C)$

Power gain $G = f(I_C)$

$V_{CE} = 10 \text{ V}$, $f = 2 \text{ GHz}$, $Z_{Lopt} (G)$

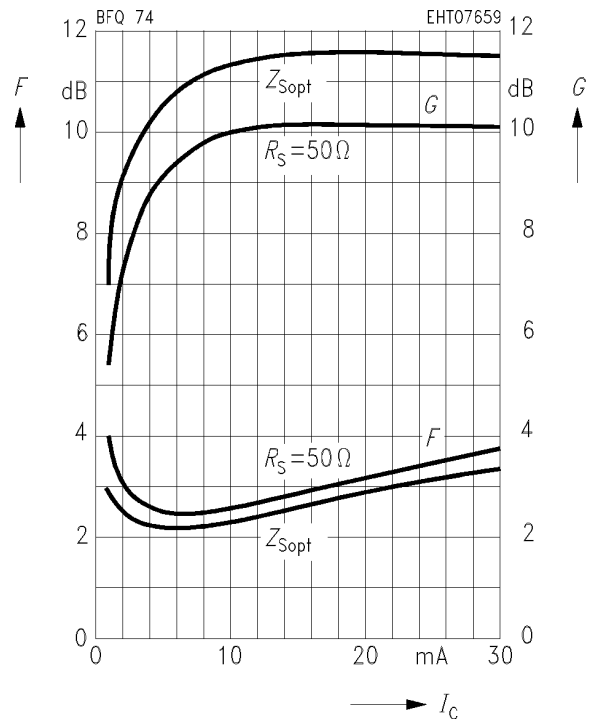

Common Emitter Power Gain

Power gain $G_{ms}, |S_{21e}|^2 = f(I_C)$

$V_{CE} = 10\text{ V}, f = 1\text{ GHz}, Z_0 = 50\ \Omega$

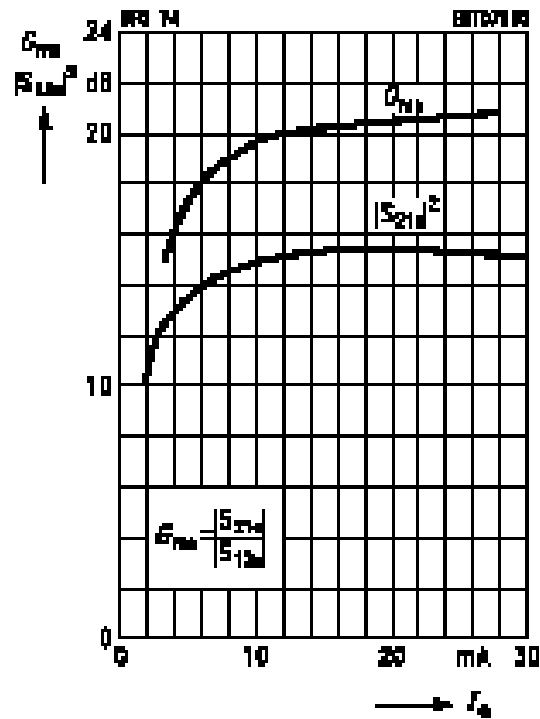

Power gain $G_{ma}, |S_{21e}|^2 = f(I_C)$

$V_{CE} = 10\text{ V}, f = 2\text{ GHz}, Z_0 = 50\ \Omega$

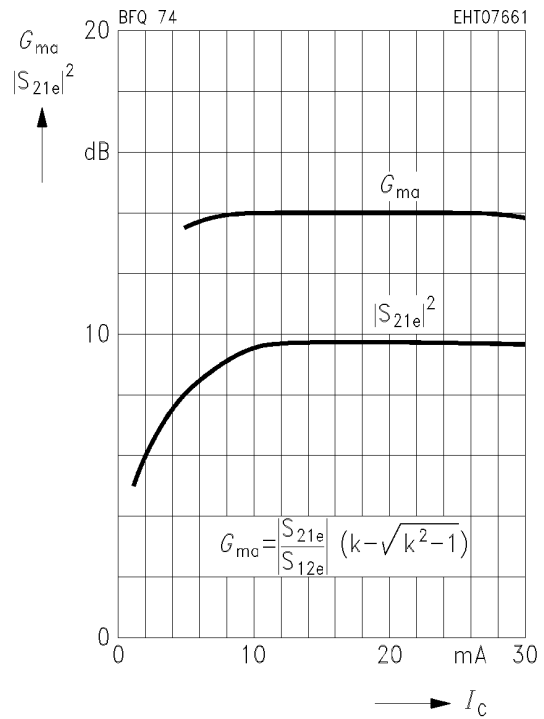

Power gain $G_{ms}, |S_{21e}|^2 = f(I_C)$

$V_{CE} = 10\text{ V}, f = 4\text{ GHz}, Z_0 = 50\ \Omega$

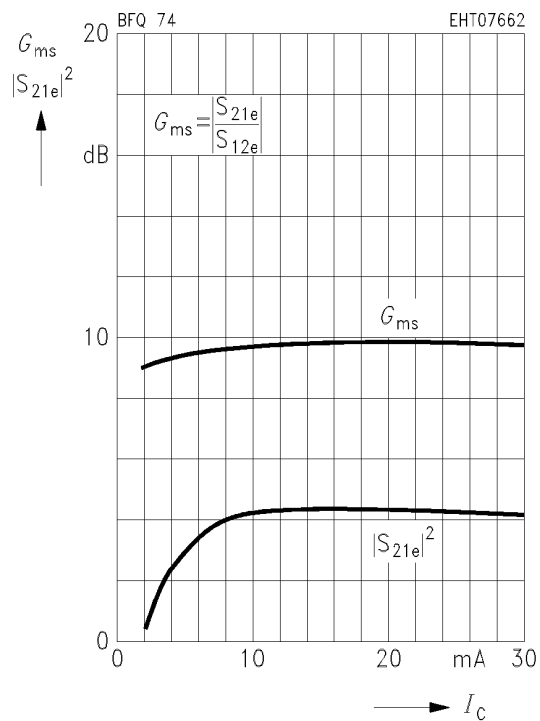

Power gain $G_{ma}, G_{ms}, |S_{21e}|^2 = f(f)$
 $I_C = 2 \text{ mA}, V_{CE} = 10 \text{ V}, Z_0 = 50 \Omega$

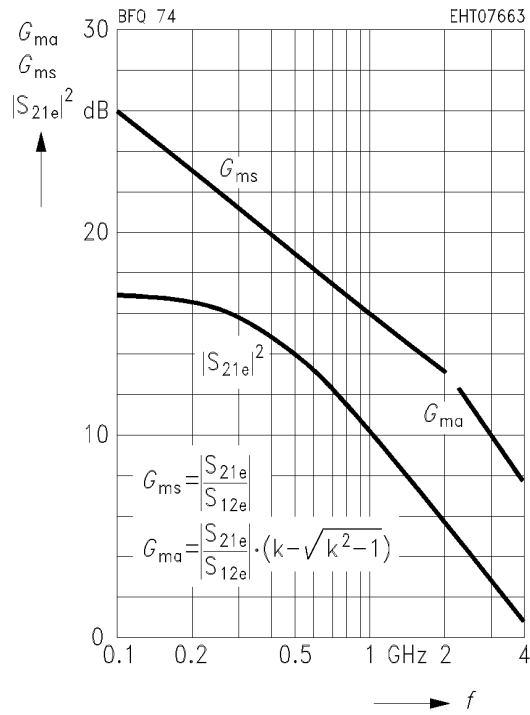

Power gain $G_{ma}, G_{ms}, |S_{21e}|^2 = f(f)$
 $I_C = 5 \text{ mA}, V_{CE} = 10 \text{ V}, Z_0 = 50 \Omega$

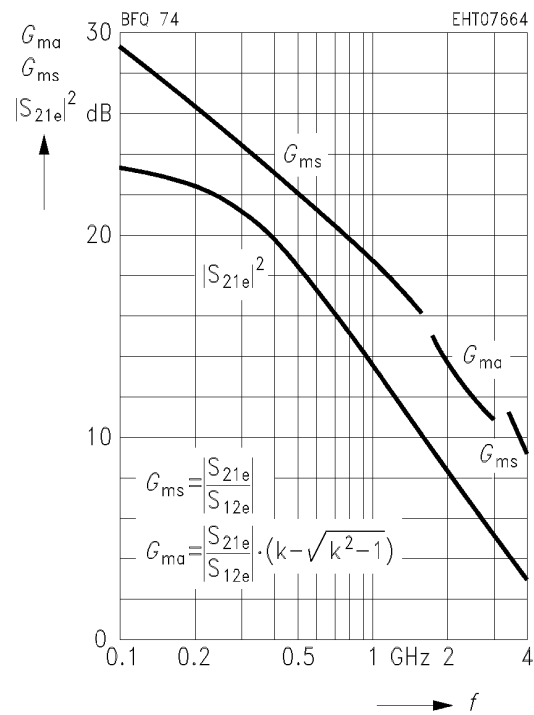

Power gain $G_{ma}, G_{ms}, |S_{21e}|^2 = f(f)$
 $I_C = 10 \text{ mA}, V_{CE} = 10 \text{ V}, Z_0 = 50 \Omega$

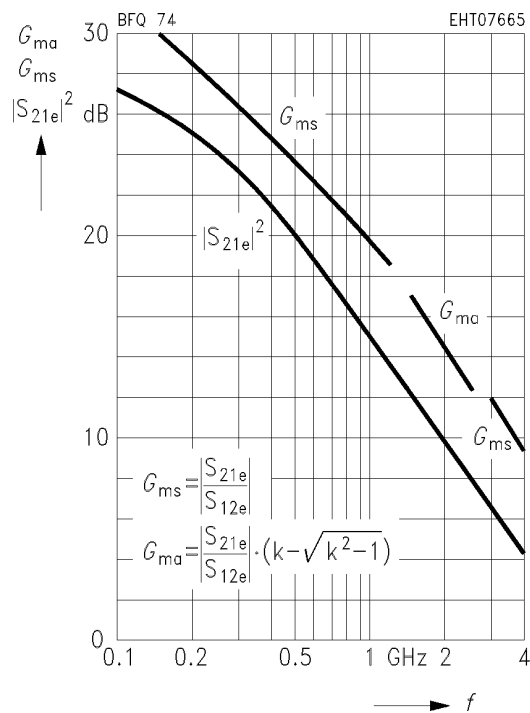

Power gain $G_{ma}, G_{ms}, |S_{21e}|^2 = f(f)$
 $I_C = 25 \text{ mA}, V_{CE} = 10 \text{ V}, Z_0 = 50 \Omega$

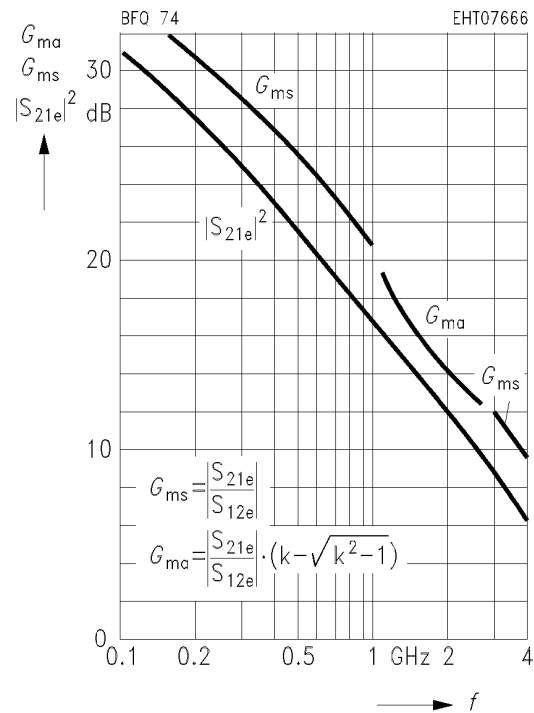

Common Emitter S Parameters

<i>f</i>	<i>S</i> ₁₁		<i>S</i> ₂₁		<i>S</i> ₁₂		<i>S</i> ₂₂	
	MAG	ANG	MAG	ANG	MAG	ANG	MAG	ANG

*I*_C = 2 mA, *V*_{CE} = 10 V, *Z*₀ = 50 Ω

0.1	0.96	- 16	6.83	169	0.017	79	0.99	- 5
0.2	0.93	- 33	6.61	155	0.034	70	0.96	- 11
0.3	0.88	- 50	6.18	144	0.049	62	0.92	- 16
0.4	0.84	- 64	5.62	134	0.060	54	0.88	- 20
0.6	0.77	- 89	4.78	118	0.076	43	0.81	- 26
0.8	0.71	- 110	3.98	104	0.085	34	0.74	- 31
1.0	0.68	- 127	3.41	93	0.089	29	0.70	- 34
1.2	0.65	- 141	2.95	84	0.091	25	0.67	- 37
1.5	0.63	- 158	2.45	72	0.091	22	0.64	- 41
1.8	0.63	- 172	2.10	62	0.092	21	0.63	- 46
2.0	0.63	179	1.91	55	0.091	21	0.61	- 49
2.5	0.64	161	1.58	41	0.092	24	0.59	- 60
3.0	0.66	145	1.36	28	0.099	29	0.59	- 71
3.5	0.68	133	1.20	15	0.113	34	0.58	- 83
4.0	0.68	118	1.07	3	0.136	35	0.58	- 97
4.5	0.71	107	0.96	- 8	0.160	34	0.58	- 111
5.0	0.72	95	0.85	- 18	0.190	29	0.60	- 127

*S*₁₁, *S*₂₂ = *f* (*f*)

*I*_C = 2 mA, *V*_{CE} = 10 V, *Z*₀ = 50 Ω

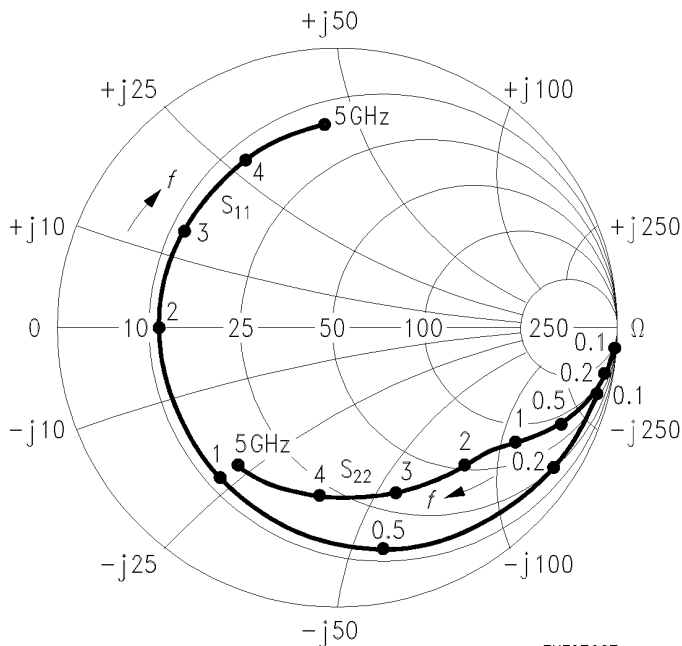

EHT07667

*S*₁₂, *S*₂₁ = *f* (*f*)

*I*_C = 2 mA, *V*_{CE} = 10 V, *Z*₀ = 50 Ω

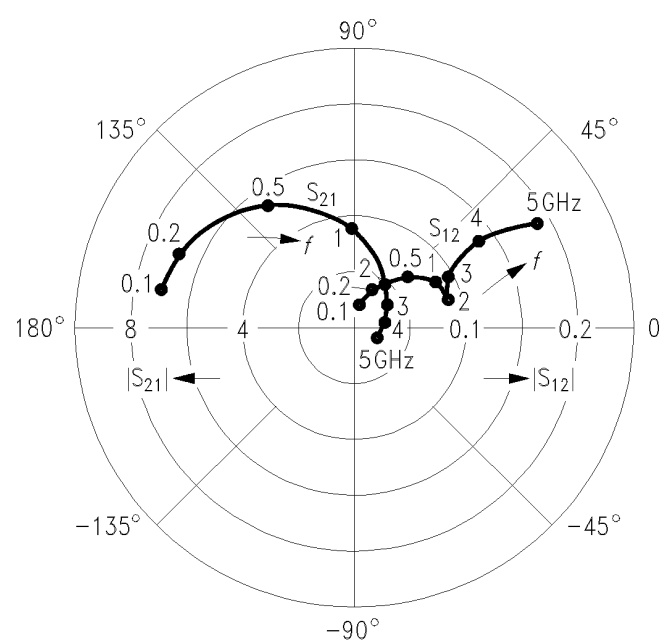

EHT07668

Common Emitter S Parameters (continued)

<i>f</i>	<i>S</i> ₁₁		<i>S</i> ₂₁		<i>S</i> ₁₂		<i>S</i> ₂₂		
	GHz	MAG	ANG	MAG	ANG	MAG	ANG	MAG	ANG
<i>I</i> _C = 5 mA, <i>V</i> _{CE} = 10 V, <i>Z</i> ₀ = 50 Ω									
0.1	0.91	- 25	14.67	163	0.017	78	0.97	- 9	
0.2	0.83	- 51	13.37	145	0.031	63	0.89	- 18	
0.3	0.75	- 72	11.62	131	0.040	54	0.80	- 24	
0.4	0.70	- 89	9.90	121	0.047	47	0.73	- 28	
0.6	0.63	- 115	7.61	105	0.056	41	0.64	- 32	
0.8	0.58	- 135	5.97	94	0.061	37	0.58	- 34	
1.0	0.57	- 150	4.92	85	0.064	36	0.54	- 36	
1.2	0.56	- 162	4.18	77	0.068	36	0.52	- 37	
1.5	0.55	- 176	3.40	68	0.073	37	0.50	- 41	
1.8	0.56	173	2.87	59	0.080	38	0.49	- 45	
2.0	0.57	166	2.60	53	0.084	39	0.47	- 48	
2.5	0.59	152	2.13	41	0.098	41	0.46	- 58	
3.0	0.61	138	1.83	29	0.116	41	0.45	- 68	
3.5	0.63	128	1.61	17	0.135	41	0.44	- 80	
4.0	0.64	114	1.44	5	0.161	37	0.45	- 94	
4.5	0.68	104	1.29	- 6	0.183	33	0.44	- 108	
5.0	0.68	93	1.16	- 16	0.209	27	0.46	- 124	

*S*₁₁, *S*₂₂ = *f* (*f*)

*I*_C = 5 mA, *V*_{CE} = 10 V, *Z*₀ = 50 Ω

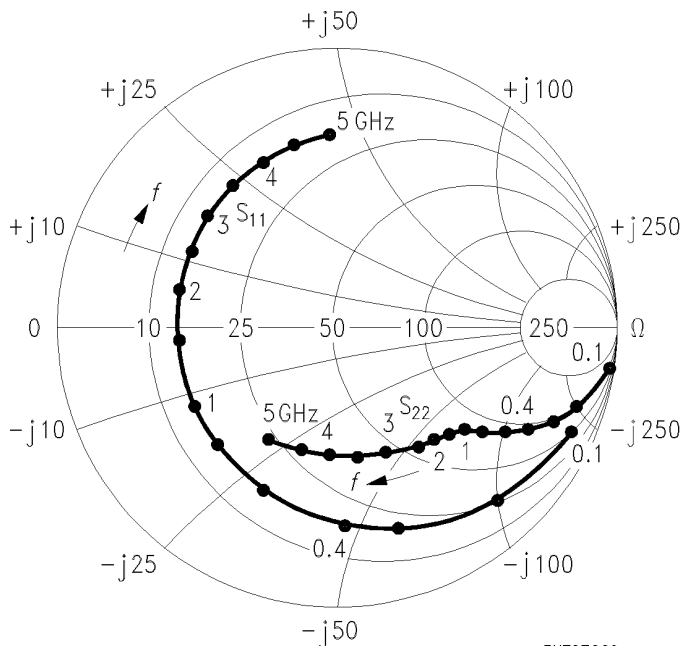

EHT07669

*S*₁₂, *S*₂₁ = *f* (*f*)

*I*_C = 5 mA, *V*_{CE} = 10 V, *Z*₀ = 50 Ω

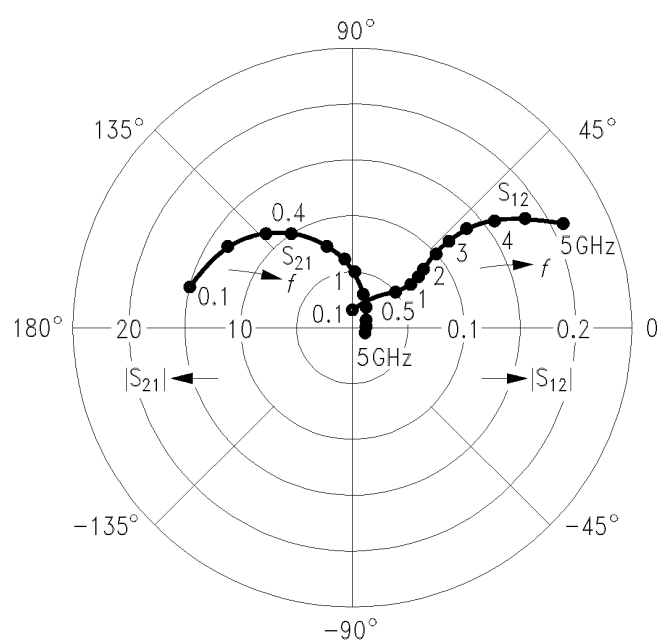

EHT07670

Common Emitter S Parameters (continued)

<i>f</i>	<i>S</i> ₁₁		<i>S</i> ₂₁		<i>S</i> ₁₂		<i>S</i> ₂₂		
	GHz	MAG	ANG	MAG	ANG	MAG	ANG	MAG	ANG
<i>I</i> _C = 10 mA, <i>V</i> _{CE} = 10 V, <i>Z</i> ₀ = 50 Ω									
0.1	0.83	- 35	22.64	155	0.015	70	0.92	- 13	
0.2	0.71	- 65	18.55	134	0.026	59	0.80	- 23	
0.3	0.63	- 89	14.98	121	0.034	53	0.70	- 27	
0.4	0.58	- 105	12.22	112	0.039	48	0.63	- 30	
0.6	0.55	- 130	8.96	98	0.047	46	0.54	- 32	
0.8	0.52	- 148	6.91	89	0.053	44	0.49	- 34	
1.0	0.53	- 161	5.64	81	0.058	45	0.46	- 35	
1.2	0.52	- 171	4.76	75	0.064	45	0.44	- 37	
1.5	0.52	176	3.87	65	0.072	46	0.43	- 40	
1.8	0.53	167	3.25	57	0.083	46	0.42	- 44	
2.0	0.55	161	2.95	52	0.089	47	0.41	- 47	
2.5	0.57	148	2.41	40	0.107	46	0.39	- 56	
3.0	0.60	135	2.06	29	0.127	43	0.38	- 67	
3.5	0.62	125	1.82	18	0.148	41	0.37	- 78	
4.0	0.63	112	1.62	6	0.173	36	0.37	- 92	
4.5	0.67	103	1.46	- 5	0.194	32	0.37	- 106	
5.0	0.67	92	1.32	- 15	0.217	25	0.38	- 123	

*S*₁₁, *S*₂₂ = *f* (*f*)

*I*_C = 10 mA, *V*_{CE} = 10 V, *Z*₀ = 50 Ω

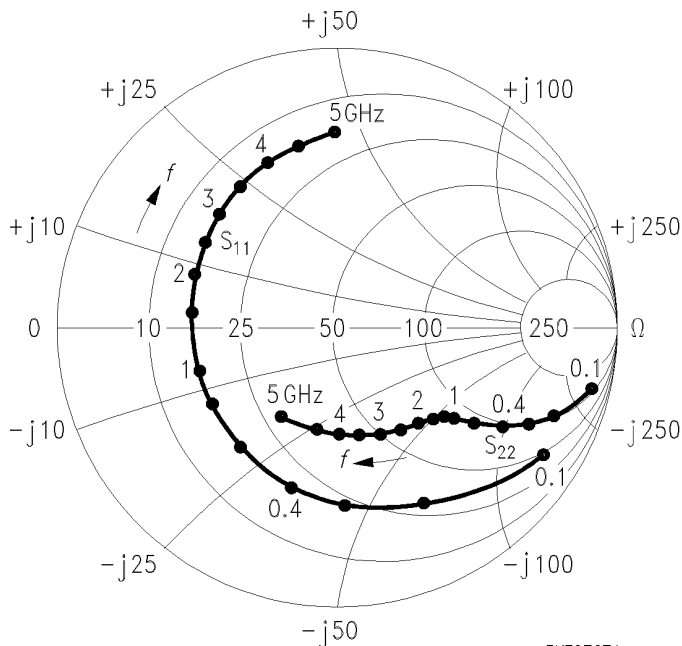

EHT07671

*S*₁₂, *S*₂₁ = *f* (*f*)

*I*_C = 10 mA, *V*_{CE} = 10 V, *Z*₀ = 50 Ω

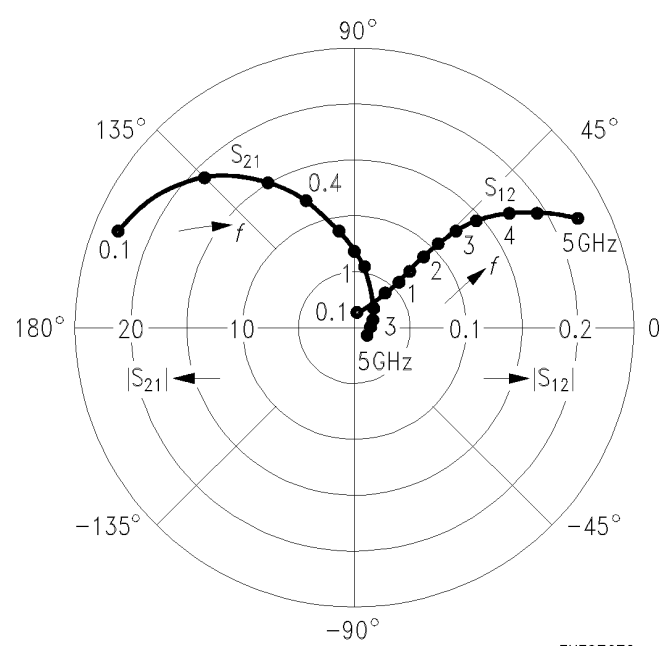

EHT07672

Common Emitter S Parameters (continued)

<i>f</i>	<i>S</i> ₁₁		<i>S</i> ₂₁		<i>S</i> ₁₂		<i>S</i> ₂₂		
	GHz	MAG	ANG	MAG	ANG	MAG	ANG	MAG	ANG
<i>I</i> _C = 15 mA, <i>V</i> _{CE} = 10 V, <i>Z</i> ₀ = 50 Ω									
0.1	0.79	- 44	29.12	151	0.015	66	0.89	- 17	
0.2	0.66	- 81	22.58	128	0.023	56	0.73	- 27	
0.3	0.59	- 107	17.37	115	0.028	50	0.61	- 30	
0.4	0.55	- 123	13.71	106	0.033	48	0.55	- 31	
0.6	0.52	- 145	9.66	93	0.039	48	0.48	- 31	
0.8	0.51	- 161	7.32	85	0.045	50	0.44	- 32	
1.0	0.52	- 171	5.92	78	0.051	51	0.42	- 33	
1.2	0.51	179	4.97	72	0.058	52	0.41	- 34	
1.5	0.51	169	4.02	63	0.068	53	0.40	- 37	
1.8	0.53	161	3.36	56	0.080	53	0.39	- 42	
2.0	0.54	156	3.04	51	0.087	52	0.38	- 45	
2.5	0.56	145	2.49	39	0.107	51	0.37	- 54	
3.0	0.59	133	2.12	28	0.128	47	0.36	- 65	
3.5	0.62	123	1.87	17	0.151	44	0.35	- 77	
4.0	0.63	111	1.67	6	0.176	38	0.35	- 91	
4.5	0.66	102	1.50	- 5	0.198	33	0.35	- 106	
5.0	0.67	91	1.35	- 15	0.222	26	0.36	- 122	

*S*₁₁, *S*₂₂ = *f* (*f*)

*I*_C = 15 mA, *V*_{CE} = 10 V, *Z*₀ = 50 Ω

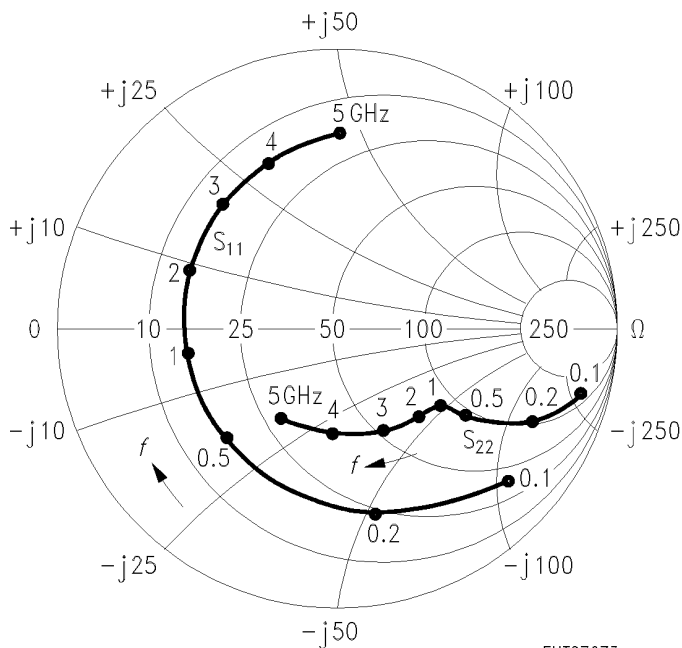

*S*₁₂, *S*₂₁ = *f* (*f*)

*I*_C = 15 mA, *V*_{CE} = 10 V, *Z*₀ = 50 Ω

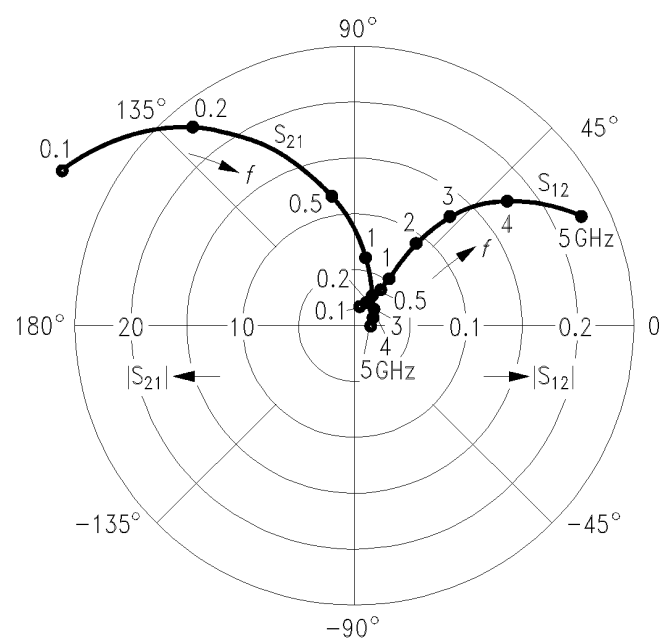

Common Emitter S Parameters (continued)

<i>f</i>	<i>S</i> ₁₁		<i>S</i> ₂₁		<i>S</i> ₁₂		<i>S</i> ₂₂		
	GHz	MAG	ANG	MAG	ANG	MAG	ANG	MAG	ANG
<i>I</i> _C = 20 mA, <i>V</i> _{CE} = 10 V, <i>Z</i> ₀ = 50 Ω									
0.1	0.73	- 51	32.84	147	0.013	69	0.86	- 18	
0.2	0.61	- 89	24.03	124	0.021	55	0.69	- 27	
0.3	0.56	- 115	18.02	111	0.026	50	0.58	- 29	
0.4	0.53	- 130	14.07	103	0.030	49	0.52	- 30	
0.6	0.51	- 151	9.80	91	0.036	51	0.46	- 30	
0.8	0.50	- 165	7.40	83	0.043	53	0.43	- 30	
1.0	0.51	- 174	5.97	76	0.050	54	0.41	- 31	
1.2	0.51	176	5.01	71	0.057	55	0.40	- 33	
1.5	0.51	167	4.04	62	0.068	56	0.39	- 36	
1.8	0.53	159	3.38	55	0.080	55	0.39	- 41	
2.0	0.55	154	3.06	50	0.087	54	0.38	- 44	
2.5	0.57	143	2.50	39	0.108	52	0.36	- 53	
3.0	0.59	132	2.13	28	0.130	48	0.36	- 64	
3.5	0.62	123	1.87	17	0.152	45	0.34	- 76	
4.0	0.63	110	1.67	5	0.178	39	0.35	- 90	
4.5	0.67	101	1.50	- 5	0.199	34	0.34	- 105	
5.0	0.68	91	1.35	- 15	0.224	27	0.36	- 122	

*S*₁₁, *S*₂₂ = *f* (*f*)

*I*_C = 20 mA, *V*_{CE} = 10 V, *Z*₀ = 50 Ω

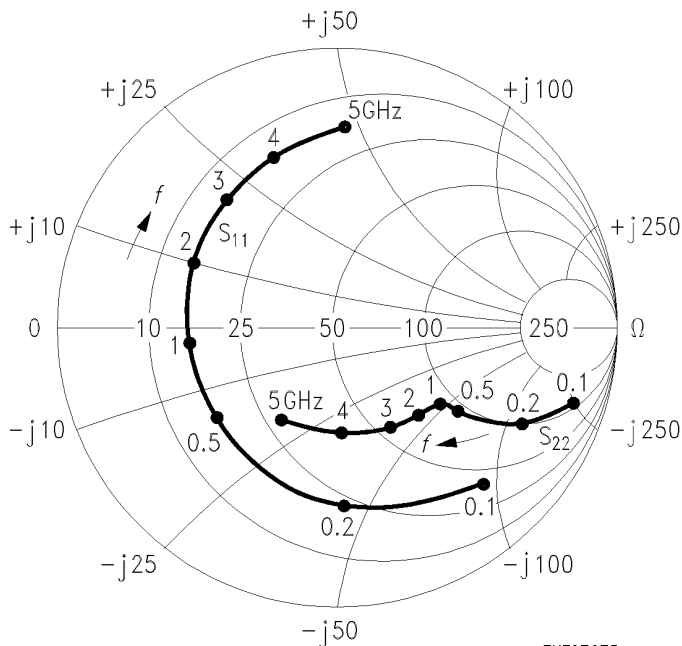

EHT07675

*S*₁₂, *S*₂₁ = *f* (*f*)

*I*_C = 20 mA, *V*_{CE} = 10 V, *Z*₀ = 50 Ω

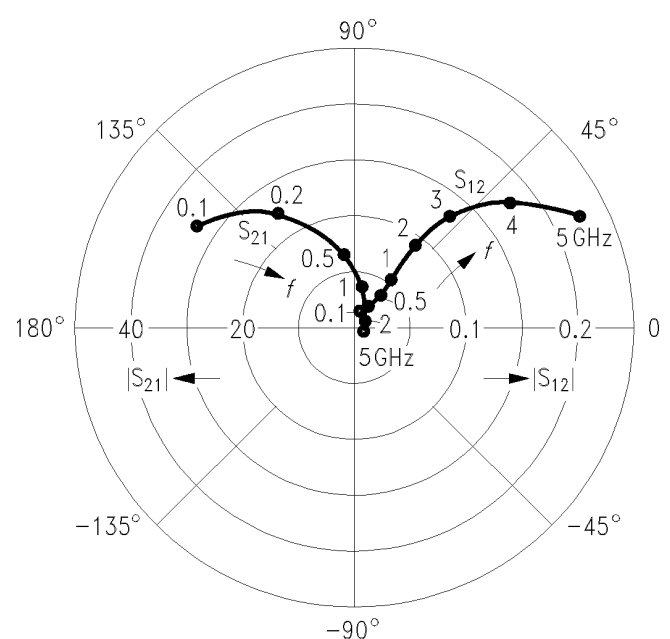

EHT07676

Common Emitter S Parameters (continued)

<i>f</i>	<i>S</i> ₁₁		<i>S</i> ₂₁		<i>S</i> ₁₂		<i>S</i> ₂₂		
	GHz	MAG	ANG	MAG	ANG	MAG	ANG	MAG	ANG
<i>I</i> _C = 25 mA, <i>V</i> _{CE} = 10 V, <i>Z</i> ₀ = 50 Ω									
0.1	0.69	- 55	34.86	143	0.013	66	0.83	- 19	
0.2	0.59	- 94	24.49	121	0.020	55	0.66	- 27	
0.3	0.54	- 120	18.09	109	0.025	50	0.56	- 29	
0.4	0.51	- 135	14.03	101	0.029	50	0.51	- 28	
0.6	0.51	- 154	9.73	90	0.035	52	0.45	- 28	
0.8	0.50	- 167	7.33	82	0.042	54	0.43	- 29	
1.0	0.52	- 176	5.90	76	0.049	56	0.41	- 30	
1.2	0.51	175	4.96	70	0.057	57	0.40	- 32	
1.5	0.52	165	4.00	62	0.068	57	0.40	- 35	
1.8	0.53	158	3.34	54	0.080	56	0.39	- 40	
2.0	0.55	153	3.02	50	0.087	55	0.38	- 43	
2.5	0.57	143	2.47	38	0.108	53	0.36	- 52	
3.0	0.60	131	2.10	27	0.130	49	0.36	- 63	
3.5	0.62	122	1.85	16	0.152	46	0.35	- 75	
4.0	0.64	110	1.65	5	0.179	40	0.36	- 90	
4.5	0.67	101	1.48	- 6	0.200	34	0.35	- 105	
5.0	0.68	90	1.33	- 16	0.224	27	0.36	- 122	

*S*₁₁, *S*₂₂ = *f* (*f*), *Z*-plane

*I*_C = 25 mA, *V*_{CE} = 10 V, *Z*₀ = 50 Ω

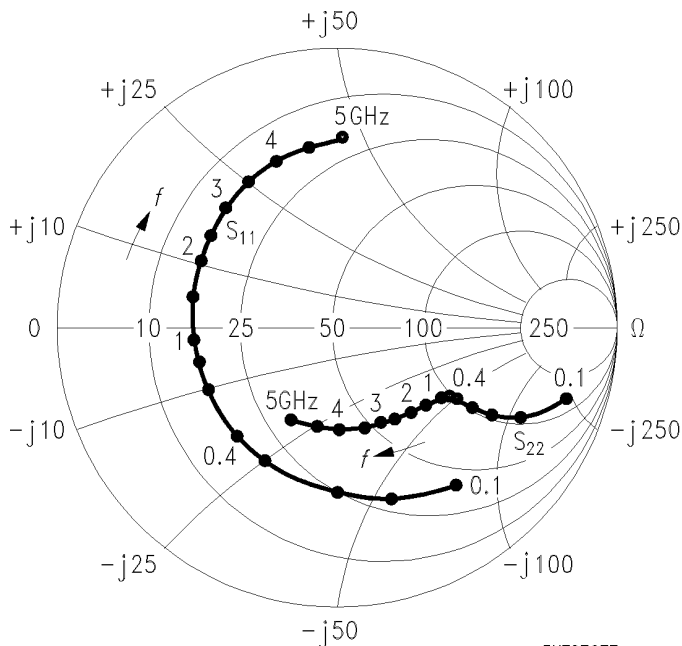

*S*₁₂, *S*₂₁ = *f* (*f*)

*I*_C = 25 mA, *V*_{CE} = 10 V, *Z*₀ = 50 Ω

