

PD153 TO-18 Type Color Sensor

T-41-51

■ Features

1. High sensitivity in long wavelength (Short-circuit current ratio)
 I_{sc2}/I_{sc1} : MIN. 4.5 at $\lambda = 900\text{nm}$
2. Output corresponding to the wavelength of light
3. High reliability can package
4. Capable of measuring from blue light to near infrared light ($\lambda = 1,000\text{nm}$)

■ Applications

1. Read out of paper currency's color in money exchanger
2. Read out of color temperature and wavelength
3. Detection of object's color

■ Outline Dimensions (Unit : mm)

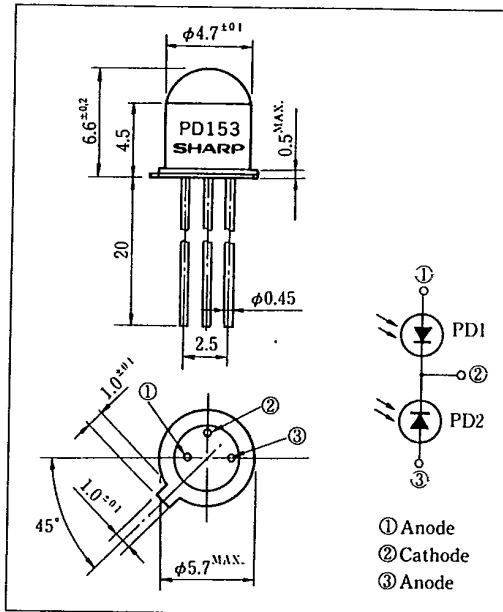

■ Absolute Maximum Ratings (Ta=25°C)

Parameter	Symbol	Rating	Unit
Reverse voltage	V_R	5.0	V
Operating temperature	T_{opr}	-15 ~ +70	°C
Storage temperature	T_{stg}	-25 ~ +100	°C
*1 Soldering temperature	T_{sol}	260	°C

*1 For 10 seconds at the position of 1.3mm from the bottom face of can package.

■ Electro-optical Characteristics (Ta=25°C)

Parameter	Symbol	Conditions	Applied	MIN.	TYP.	MAX.	Unit
Reverse voltage	V_R	$I_R = 1\mu\text{A}$	PD1, PD2	5.0	—	—	V
Dark current	I_d	$V_R = 1\text{V}$	PD1, PD2	—	0.05	5	nA
Terminal capacitance	C_{t1}	$V_R = 0, f = 1\text{MHz}$	PD1	—	300	600	pF
	C_{t2}	$V_R = 0, f = 1\text{MHz}$	PD2	—	100	200	pF
*2 Short circuit current	I_{sc1}	*3 $E_e = 1.0\text{mW}/\text{cm}^2$	PD1	—	4.5	—	μA
	I_{sc2}	*3 $E_e = 1.0\text{mW}/\text{cm}^2$	PD2	—	10.0	—	μA
*4 Short circuit current ratio	I_{sc2}/I_{sc1}	$\lambda = 600\text{nm}$	PD1, PD2	0.14	0.24	0.39	—
		$\lambda = 900\text{nm}$	PD1, PD2	4.5	5.10	8.4	—

*2 Values for 1 element. Measured with short circuit between the anode and the cathode of non-measurement elements.

*3 E_e : Illuminance by CIE standard light source A (tungsten lamp)

*4 Short circuit current ratio (I_{sc2}/I_{sc1}) shall be measured under that both short circuit currents I_{sc1}, I_{sc2} are $0.05 \sim 10\mu\text{A}$.

Theory of Operation

The semiconductor color sensor PD153 is an element of two PN-junctions (photodiodes) vertically incorporated into a substrate with its thickness of silicon acting as an optical filter.

This means, as shown in Fig. 2, that with the lights of short wavelength absorbed near the surface of silicon and those of long wavelength going deeper to be absorbed, the photodiode PD1 of the less deep PN-junction will have greater sensitivity to short wavelength lights while the photodiode PD2 of the deeper PN-junction will have greater sensitivity to long wavelength lights. These characteristics are shown in Fig. 3.

According to this spectral sensitivity, as a signal processing method for picking up a signal (color signal) corresponding to its wavelength of light, the short circuit current ratio between the two photodiodes above mentioned is used.

From Fig. 3, the relationship between the short circuit current ratio (I_{SC2}/I_{SC1}) and the wavelength of the incident light (λ) can be obtained as shown in Fig. 4. As it is obvious in this figure, there is the 1-to-1 correspondence between one wavelength and the short circuit current ratio in indicate that the reading of color of light (wavelength) is possible.

Thus, the wavelengths of blue to near infrared color can be read by PD153.

Also taken into account to make the color signal reading capability as close to that of human eye as possible is the fact the human eye is insensitive to wavelength of over 700nm.

Next, concretely described in Fig. 3 and Fig. 4 will be a case with a monochromatic light striking upon the semiconductor color sensor and a case with a composite light of various wavelengths striking upon it.

- (1) When a monochromatic light of wavelength ($\lambda = 500\text{nm}$) strikes upon it :

The short circuit current ratio of PD1 and PD2 are obtained from Fig. 3 :

$$I_{SC2}/I_{SC1} = 0.035C_1/10.595C_1 = 0.059 \quad (C_1 : \text{constant})$$

corresponds to the short circuit current ratio shown in Fig. 4.

Fig. 1 Structure of Semiconductor Color Sensor

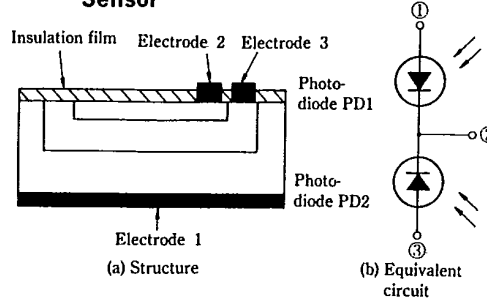

Fig. 2 Wavelength and Light Absorption Areas

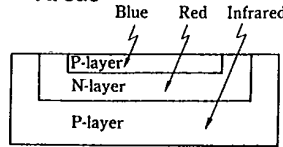

Fig. 3 Spectral Sensitivity

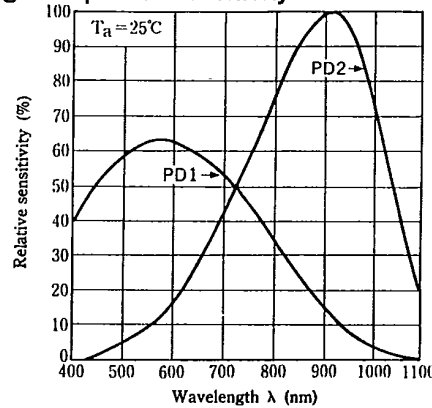
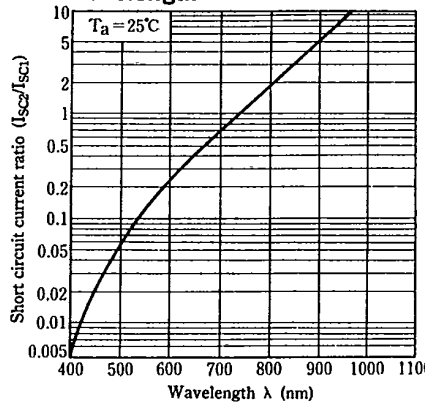

Fig. 4 Short Circuit Current Ratio vs. Wavelength



4

(2) When a composite light of various wavelengths (visible and near infrared) strikes upon it :

Suppose the incident light is made up of a light (A) : wavelength $\lambda_A=500\text{nm}$, irradiance $E_{eA}=5.0\text{mW}/\text{cm}^2$

and

a light (B) : wavelength $\lambda_B=800\text{nm}$, irradiance $E_{eB}=3.0\text{mW}/\text{cm}^2$

The human eye will recognize this incident light as of about 500nm wavelength while this semiconductor color sensor will recognize the same light as follows.

The short circuit current for PD1 and PD2, from Fig. 3, is

$$I_{SC1} = (5 \times 0.595 + 3 \times 0.350) C_2 = 4.025$$

$$(C_2 : \text{constant}) \dots\dots\dots 1$$

$$I_{SC2} = (5 \times 0.035 + 3 \times 0.760) C_2 = 2.455 C_2$$

$$(C_2 : \text{constant}) \dots\dots\dots 2$$

From the equations 1 and 2, the short circuit current ratio can be obtained. Thus, $I_{SC2}/I_{SC1} = 0.610$

So, the wavelength that corresponds to the short circuit current ratio of 0.610 according to Fig. 4, is $\lambda = 690\text{nm}$, which the PD153 recognizes.

As made clear by the above examples, with an incident light made up of a visible light together with a near infrared light, the wavelength the human eye recognizes is not necessarily the same wavelength a semiconductor color sensor recognizes.

Usage (Sample Signal Processing Circuit)

Fig. 5 shows a block diagram of a signal processing circuit for a wavelength detector using a semiconductor color sensor.

Each of the short circuit current I_{SC1} and I_{SC2} to be obtained from the two photodiodes is to be logarithmically compressed and go through the subtraction circuit to produce a reduced output voltage of V_o . Therefore, the following equation can be formulated.

$$V_o \propto \log I_{SC2} - \log I_{SC1} = \log (I_{SC2}/I_{SC1})$$

As made clear in the spectral sensitivity characteristics in Fig. 3, the value I_{SC2}/I_{SC1} will be constant regardless of the intensity of the incident light, the output voltage will not

Fig. 5 Block Diagram of a Sample Signal Processing Circuit

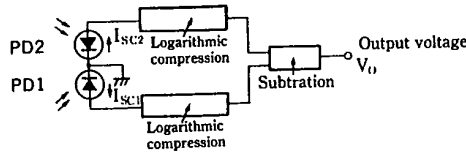

Fig. 6 Example of Signal Processing Circuit

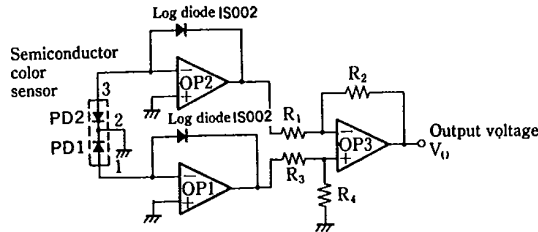

Fig. 7 Output voltage vs. Wavelength (Typical)

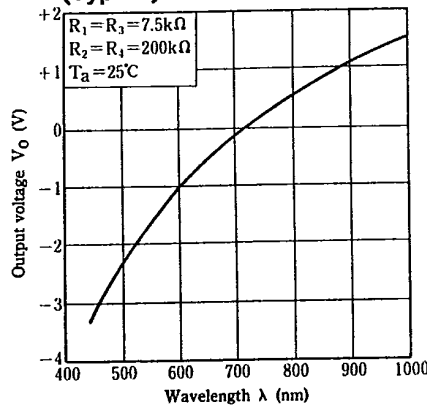
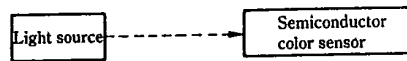

Fig. 8 Measurement of Color Temperature and Wavelength of Light Source



T-41-51

change as the above formula indicates.

A example of signal processing circuit and a typical correlation between the output voltage V_o and the wavelength of the incident light are shown in Fig. 6 and Fig. 7 respectively.

■ Applications

The semiconductor color sensor may find its applications in the following examples.

- ① Measurement of color temperature and wavelength of light source.....See Fig. 8. Measure or control the color temperature or the wavelength of the light source, the light from which is made to strike directly upon the semiconductor color sensor.
- ② Color measurement of an object (transmissive type).....See Fig. 9. Measure the color of the object through which the light transmits to strike upon the semiconductor color sensor.
- ③ Color measurement of an object (reflective type)See Fig. 10. Measure the color of the object which reflects the light to have it strike upon the semiconductor color sensor.

Fig. 9 Transmissive Type
(Color Measurement of an Object)

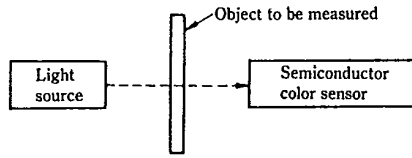
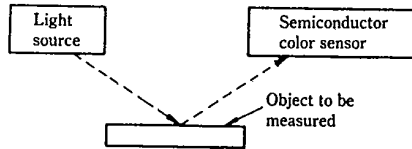

Fig. 10 Reflective Type
(Color Measurement of an Object)



4