

SLOTTED PHOTOINTERRUPTER

MIT-5A116-U

Description

The MIT-5A116-U consists of a Gallium Arsenide infrared emitting diode and a NPN silicon phototransistor built in a black plastic housing. It is a transmissive subminiature photointerrupter.

Package Dimensions

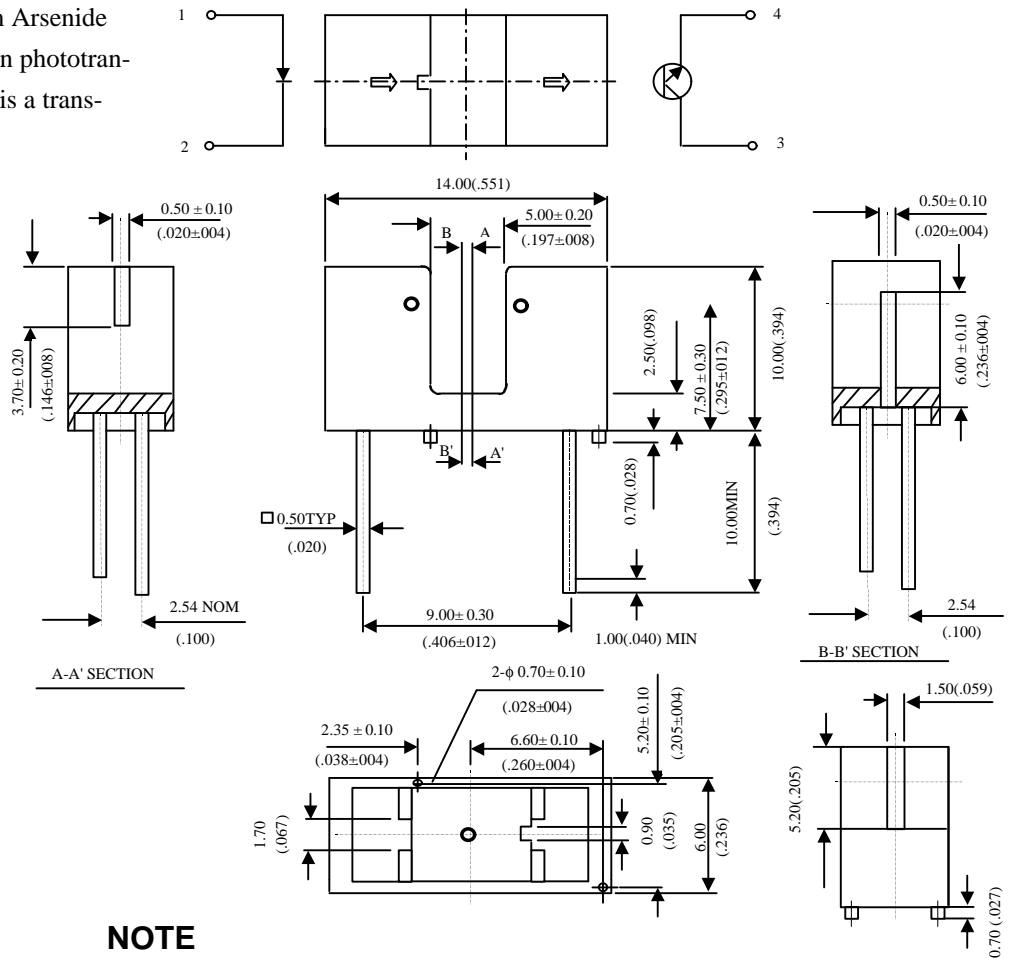

NOTE

1. Tolerance is ± 0.25 mm (.006") unless otherwise noted.

Absolute Maximum Ratings

				@T _A = 25°C
Parameter		Symbol	Maximum Rating	Unit
INPUT	Continuous Forward Current	I _F	50	mA
	Reverse Voltage	V _R	5	V
	Power Dissipation	P _{ad}	75	mW
OUTPUT	Collector-emitter breakdown voltage	V _{(BR)CEO}	30	V
	Emitter-Collector breakdown voltage	V _{(BR)ECO}	5	V
	Collector power dissipation	P _C	75	mW
Total power dissipation		P _{TOT}	100	mW
Operating Temperature Range		T _{opr}	-25°C to + 85°C	
Storage Temperature Range		T _{stg}	-40°C to + 100°C	

UNI

Unity Opto Technology Co., Ltd.

04/01/2002

Optical-Electrical Characteristics

@T_A = 25°C

Parameter		symbol	Min.	Typ.	Max.	Unit.	Test Conditions
Input	Forward Voltage	V _F	-	1.2	1.4	V	I _F = 20mA
	Reverse Current	I _R	-	-	10	μA	V _R = 5V
Output	Collector Dark Current	I _{ceo}	-	-	100	nA	V _{ce} = 10V
	Collector Emitter Saturation Voltage	V _{CE(SAT)}	-	-	0.4	V	I _c = 0.1mA, E _e = 0.1mW/cm ²
Transfer Characteristics	Collector Current	I _c (on)	0.4	-	4	mA	I _F = 20mA, V _{ce} = 5V
	Response Time (RISE)	t _r	-	20	100	μS	I _c = 100μA, V _{ce} = 5V
	Response Time (FALL)	t _f	-	20	100	μS	R _L = 1k, d = 1mm

Typical Optical-Electrical Characteristic Curves

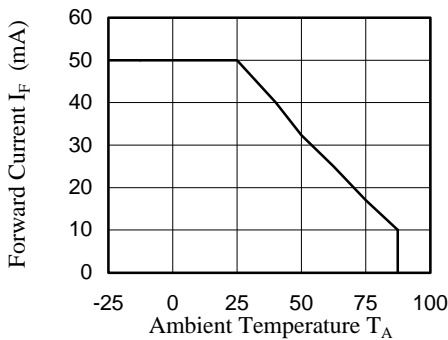

Fig.1 forward Current vs. Ambient Temperature

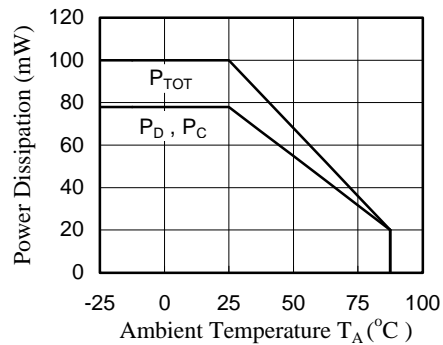

Fig.2 Power Dissipation vs Ambient Temperature

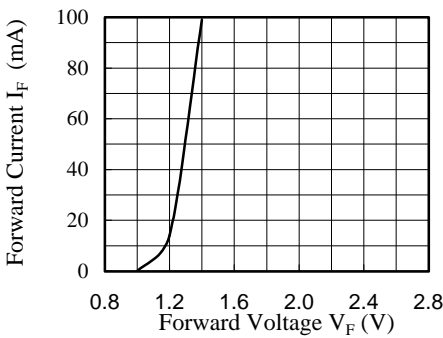

Fig.3 Forward Current vs Forward Voltage

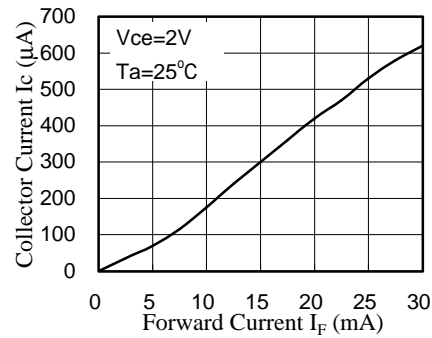

Fig.4 Collector Current vs Forward Voltage

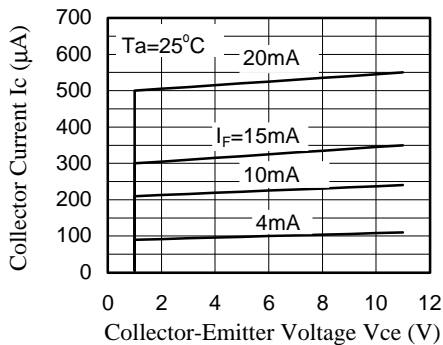

Fig.5 Collector Current vs. V_{ce}

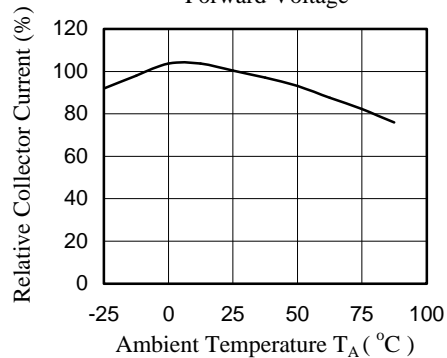

Fig.6 Relative Collector Current vs. T_A

Typical Optical-Electrical Characteristic Curves

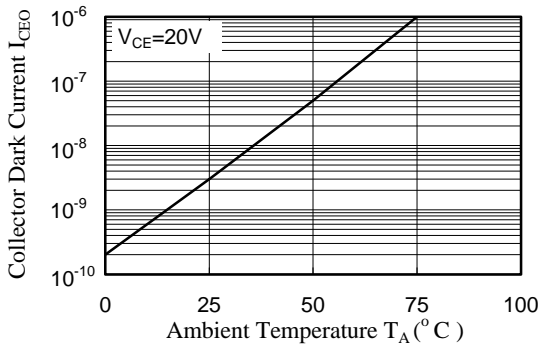

Fig.7 Collector Dark Current vs. Ambient Temperature

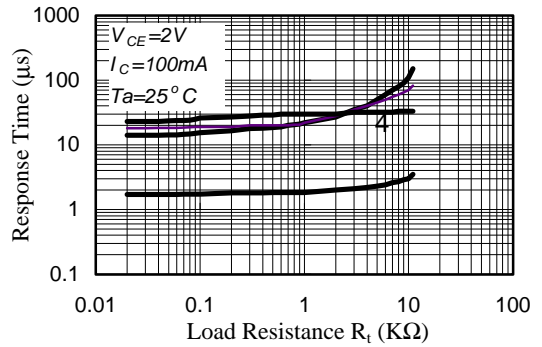

Fig.8 Response Time vs. Load Resistance

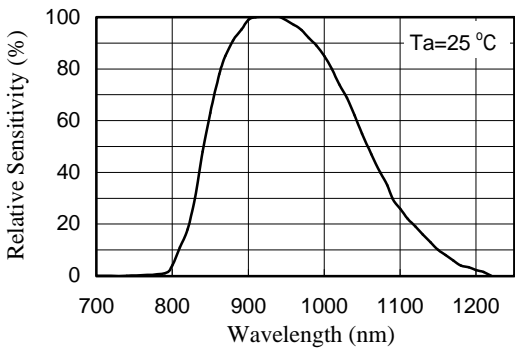
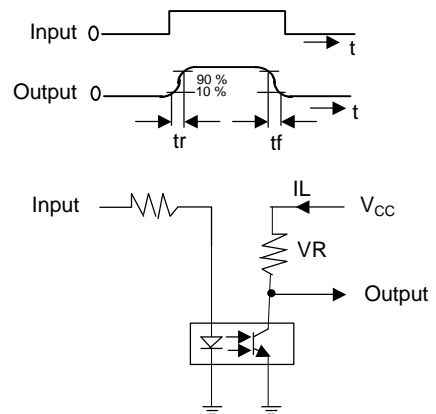

Fig.9 Spectral Sensitivity (Detecting side)

Response Time Measurement Circuit



Sensing Position Characteristics (Typical)

