

- ◆ Synchronous Step-Down DC/DC Controllers
- ◆ Input Voltage Range 2.0V ~ 10V
- ◆ Maximum Duty Cycle
- ◆ Output Voltage Externally Set-up
- ◆ Oscillation Frequency 300kHz (Accuracy  $\pm 15\%$ )
- ◆ PWM, PWM/PFM Externally Selectable 100% (TYP.)
- ◆ Synchronous Rectification Control
- ◆ High Efficiency 95% (TYP.)
- ◆ Small MSOP-8A Packaging

### ■ GENERAL DESCRIPTION

The XC9210 is a synchronous PWM, PWM/PFM controller designed for low voltage step-down DC/DC converter applications. High efficiency is obtained through the use of a synchronous rectification topology. Efficiencies are maximised by using the low RDSon N-Channel MOSFET switch which replaces the catch diode used in standard buck circuits.

The operation of the XC9210 series can be switched between PWM and PWM/PFM externally using the MODE pin. In PWM/PFM mode the XC9210 automatically switches from PWM to PFM during light loads and high efficiencies can be achieved over a wide range of load conditions. Output noise is reduced in PWM operation as the frequency is fixed.

The XC9210 has an 0.9V ( $\pm 2.0\%$ ) internal voltage, and using externally connected components, the output voltage can be set freely between 0.9V to 6.0V. With an internal switching frequency of 300kHz and 180kHz (custom) smaller, low cost external components can also be used.

Soft-start time is internally set to 10msec offering protection against in-rush currents during start-up and preventing voltage overshoot.

### ■ TYPICAL APPLICATION CIRCUIT

<XC9210B093, VOUT:3.3V>

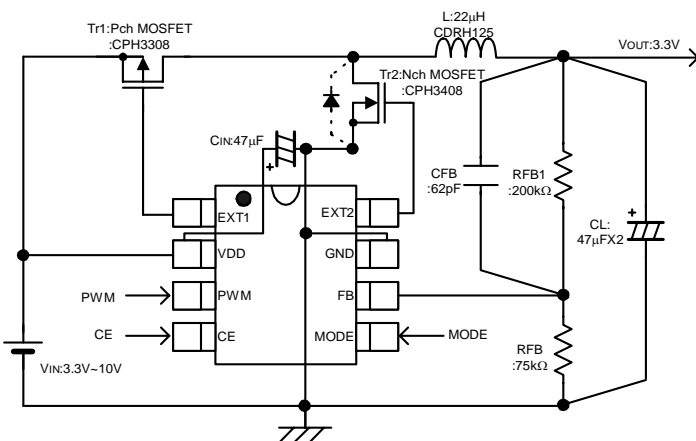

### ■ APPLICATIONS

- PDAs
- Palmtop computers
- Portable audios
- Various power supplies

### ■ FEATURES

Input Voltage Range	: 2.0V ~ 10V
Output Voltage Range	: 0.9V ~ 6.0V Can be set freely with 0.9V ( $\pm 2.0\%$ ) of reference voltage supply and external components.
Oscillation Frequency	: 300kHz $\pm 15\%$ (180kHz is available as custom)
Output Current	: More than 2A (VIN = 5.0V, VOUT=3.3V)
Stand-By Function	: 3.0µA (MAX.)
Package	: MSOP-8A
Soft-start internally set-up	: 10 ms (internally set-up)

### ■ TYPICAL PERFORMANCE CHARACTERISTICS

- Efficiency vs. Output Current

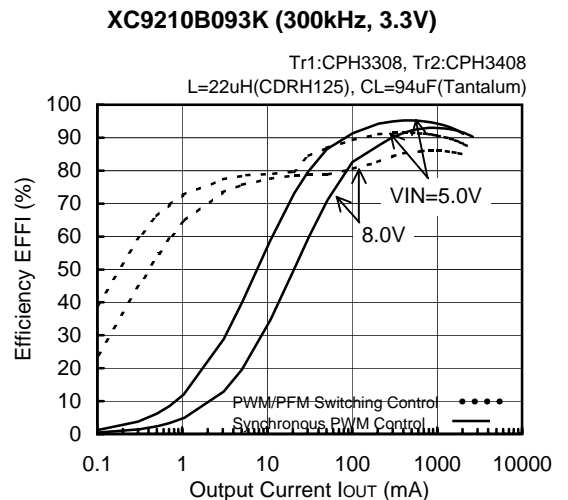

### ■ PIN CONFIGURATION

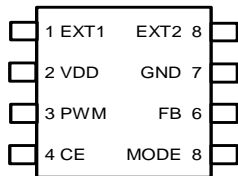

MSOP-8A  
(TOP VIEW)

### ■ PIN ASSIGNMENT

PIN NUMBER	PIN NAME	FUNCTIONS
1	EXT 1 /	External Transistor Drive Pin <Connected to High Side of Pch Power MOSFET Gate>
2	VDD	Supply Voltage
3	PWM	PWM/PFM Switching Pin <PWM control when connected to VDD, PWM / PFM auto switching when connected to Ground. >
4	CE	Chip Enable Pin <Connected to Ground when output is stand-by mode. Connected to VDD when output is active. EXT/1 is high and EXT2/ is low when in stand-by mode.>
5	MODE	Synchronous / Non-Synchronous Rectification Switching Pin <Synchronous operation when MODE pin and PWM pin are connected to VDD, Non-Synchronous operation when MODE pin and PWM pin are connected to Ground. Regardless of MODE pin, Non-Synchronous operation when PWM pin is connected to Ground.
6	FB	Output Voltage Monitor Feedback Pin <Threshold value : 0.9V. Output voltage can be set freely by connecting split resistors between VOUT and Ground.>
7	GND	Ground
8	EXT 2	External Transistor Drive Pin <Connected to Low side of Nch Power MOSFET Gate>

### ■ ORDERING INFORMATION

XC9210①②③④⑤⑥

DESIGNATOR	SYMBOL	DESCRIPTION	
①	B	Standard	
②	0	FB Voltage	
③	9	0.9V	
④		Switching Frequency	
	2	180kHz (custom)	
	3	300kHz	
⑤	K	Package	MSOP-8A
⑥	R	Embossed Tape	Standard Feed
	L		Reverse Feed

### ■ PACKAGE INFORMATION

○ MSPO-8A

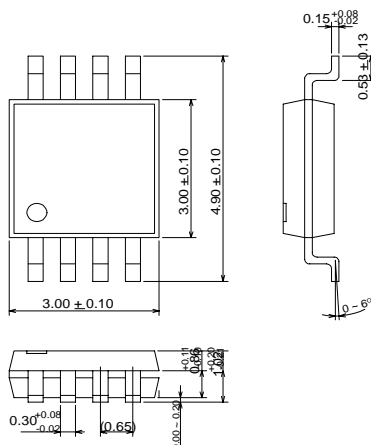

### ■ BLOCK DIAGRAM

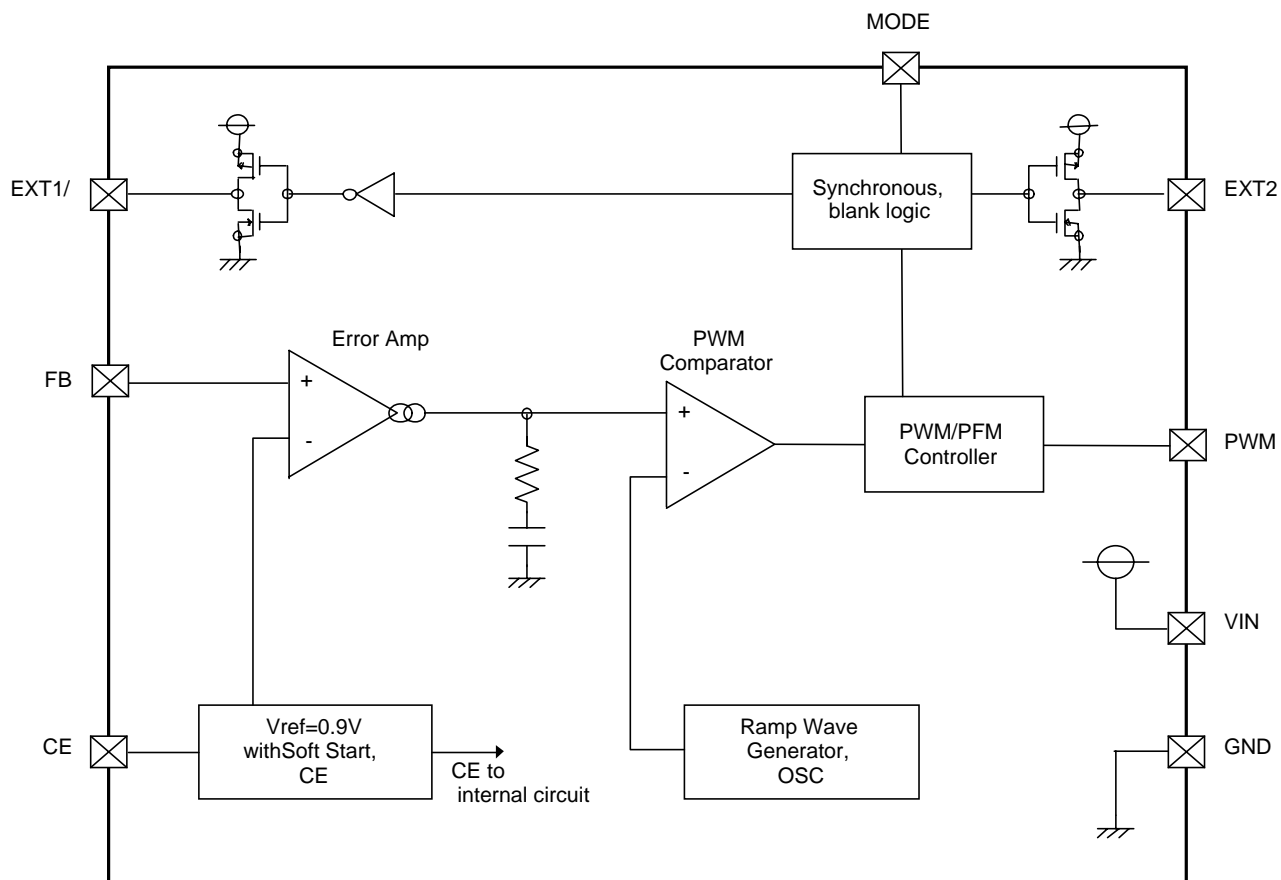

### ■ ABSOLUTE MAXIMUM RATINGS

Ta=25°C

PARAMETER	SYMBOL	RATINGS	UNITS
VDD Pin Voltage	VDD	- 0.3 ~ 12	V
FB Pin Voltage	VFB	- 0.3 ~ 12	V
CE Pin Voltage	VCE	- 0.3 ~ 12	V
PWM Pin Voltage	VPWM	- 0.3 ~ 12	V
MODE Pin Voltage	VMODE	- 0.3 ~ 12	V
EXT1, 2 Pin Voltage	VEXT	- 0.3 ~ VDD + 0.3	V
EXT1, 2 Pin Current	IEXT	±100	mA
Power Dissipation	Pd	150	mW
Operating Ambient Temperature	Topr	- 40 ~ + 85	°C
Storage Temperature	Tstg	- 55 ~ +125	°C

### ELECTRICAL CHARACTERISTICS

XC9210B093

(FOSC = 300kHz)

Ta=25°C

PARAMETER	SYMBOL	CONDITIONS	MIN.	TYP.	MAX.	UNITS	TEST CIRCUIT
Supply Voltage	VDD	MODE = 0V	2.0	-	10.0	V	①
Maximum Input Voltage	VIN	MODE = 0V	10.0	-	-	V	①
Output Voltage Range(note 1)	VOUTSET	VIN ≥ 2.0V, MODE = 0V, IOUT=1mA	0.9	-	VIN	V	①
Supply Current 1	IDD1	FB = 0V	-	65	120	μA	②
Supply Current 2	IDD2	FB = 1.0V	-	65	120	μA	②
Stand-by Current	ISTB	Same as IDD1, CE = 0V	-	-	3.0	μA	②
Oscillation Frequency	FOSC	Same as IDD1	255	300	345	kHz	②
FB Voltage	VFB	VIN=3.0V, IOUT=10mA	0.882	0.900	0.918	V	③
Minimum Operation Voltage	VINmin		-	-	2.0	V	①
Maximum Duty Ratio	MAXDTY	Same as IDD1	100	-	-	%	②
Minimum Duty Ratio	MINDTY	Same as IDD2	-	-	0	%	②
PFM Duty Ratio	PFMDTY	No Load, VPWM=0V	22	30	38	%	④
Efficiency1 (note 2)	EFF1	IOUT1=300mA (note 3)	-	96	-	%	④
Soft-Start Time	TSS	VOUT × 0.95V, CE=0V→0.65V	5.0	10.0	20.0	mS	④
EXT1 "High" ON Resistance	REXTBH1	CE1 = 0, EXT1= VDD - 0.4V	-	26	37	Ω	⑤
EXT1 "Low" ON Resistance	REXTBL1	FB = 0V, EXT1 = 0.4V	-	19	30	Ω	⑤
EXT2 "High" ON Resistance	REXTBH2	EXT2 = VDD - 0.4V	-	23	31	Ω	⑤
EXT2 "Low" ON Resistance	REXTBL2	CE = 0V, EXT2 = VDD - 0.4V	-	19	30	Ω	⑤
PWM "High" Voltage	VPWMH	No Load	0.65	-	-	V	④
PWM "Low" Voltage	VPWML	No Load	-	-	0.20	V	④
MODE "High" Voltage	VMODEH	No Load	0.65	-	-	V	④
MODE "Low" Voltage	VMODEL	No Load	-	-	0.20	V	④
CE "High" Voltage	VCEH	FB = 0V	0.65	-	-	V	②
CE "Low" Voltage	VCEL	FB = 0V	-	-	0.2	V	②
PWM "High" Current	IPWMH		-	-	0.5	μA	②
PWM "Low" Current	IPWML	PWM=0V	-	-	- 0.5	μA	②
MODE "High" Current	IMODEH		-	-	0.5	μA	②
MODE "Low" Current	IMODEL	MODE = 0V	-	-	- 0.5	μA	②
CE "High" Current	ICEH		-	-	0.5	μA	②
CE "Low" Current	ICEL	CE = 0V	-	-	- 0.5	μA	②
FB "High" Current	IFBH		-	-	0.50	μA	②
FB "Low" Current	IFBL	FB = 1.0V	-	-	- 0.50	μA	②

Unless otherwise stated, VDD = 3.0V, CE = 3.0V, PWM = 3.0V, FB = 3.0V, EXT1, 2=OPEN, MODE = 3.0V, VIN=4.2V

- Notes
- 1) Please be careful not to exceed the breakdown voltage level of the peripheral parts.
  - 2)  $EFF1 = \left\{ \frac{(\text{Output voltage}) \times (\text{Output current})}{(\text{Input voltage}) \times (\text{Input Current})} \right\} \times 100$
  - 3) Tr1 : CPH3308 (SANYO)  
 Tr2 : CPH3408 (SANYO)  
 L : 22μH (SUMIDA CDRH125)  
 CL : 16V, 47μF x 2 (NICHICEMI Tantalum MCE Series)  
 CIN : 16V, 47μF (NICHICEMI Tantalum MCE Series)  
 RFB1 : 200kΩ  
 RFB2 : 75kΩ  
 CFB : 62pF

XC9210B092

(FOSC = 180kHz)

Ta=25°C

PARAMETER	SYMBOL	CONDITIONS	MIN.	TYP.	MAX.	UNITS	TEST CIRCUIT	
Supply Voltage	VDD	MODE = 0V	2.0	-	10.0	V	①	
Maximum Input Voltage	VIN	MODE = 0V	10.0	-	-	V	①	
Output Voltage Range(note 1)	VOUSET	VIN ≥ 2.0V, MODE = 0V, IOU=1mA	VOUT	0.9	-	VIN	V	①
Supply Current 1	IDD1	FB = 0V	-	45	105	μA	②	
Supply Current 2	IDD2	FB = 1.0V	-	45	105	μA	②	
Stand-by Current	ISTB	Same as IDD1, CE = 0V	-	-	3.0	μA	②	
Oscillation Frequency	FOSC	Same as IDD1	153	180	207	kHz	②	
FB Voltage	VFB	VIN=3.0V, IOU=10mA	0.882	0.900	0.918	V	③	
Minimum Operation Voltage	VINmin		-	-	2.0	V	①	
Maximum Duty Ratio	MAXDTY	Same as IDD1	100	-	-	%	②	
Minimum Duty Ratio	MINDTY	Same as IDD2	-	-	0	%	②	
PFM Duty Ratio	PFMDTY	No Load, VPWM=0V	22	30	38	%	④	
Efficiency1 (note 2)	EFFI	IOU1=300mA (note 3)	-	96	-	%	④	
Soft-Start Time	TSS	VOUT1 × 0.95V, CE=0V→0.65V	5.0	10.0	20.0	mS	④	
EXT1 "High" ON Resistance	REXTBH1	CE1 = 0, EXT1= VDD - 0.4V	-	26	37	Ω	⑤	
EXT1 "Low" ON Resistance	REXTBL1	FB = 0V, EXT1 = 0.4V	-	19	30	Ω	⑤	
EXT2 "High" ON Resistance	REXTBH2	EXT2 = VDD - 0.4V	-	23	31	Ω	⑤	
EXT2 "Low" ON Resistance	REXTBL2	CE = 0V, EXT2 = VDD - 0.4V	-	19	30	Ω	⑤	
PWM "High" Voltage	VPWMH	No Load	0.65	-	-	V	④	
PWM "Low" Voltage	VPWML	No Load	-	-	0.20	V	④	
MODE "High" Voltage	VMODEH	No Load	0.65	-	-	V	④	
MODE "Low" Voltage	VMODEL	No Load	-	-	0.20	V	④	
CE "High" Voltage	VCEH	FB = 0V	0.65	-	-	V	②	
CE "Low" Voltage	VCEL	FB = 0V	-	-	0.20	V	②	
PWM "High" Current	IPWMH		-	-	0.50	μA	②	
PWM "Low" Current	IPWML	PWM=0V	-	-	- 0.50	μA	②	
MODE "High" Current	IMODEH		-	-	0.50	μA	②	
MODE "Low" Current	IMODEL	MODE = 0V	-	-	- 0.50	μA	②	
CE "High" Current	ICEH		-	-	0.50	μA	②	
CE "Low" Current	ICEL	CE = 0V	-	-	- 0.50	μA	②	
FB "High" Current	IFBH		-	-	0.50	μA	②	
FB "Low" Current	IFBL	FB = 1.0V	-	-	- 0.50	μA	②	

Unless otherwise stated, VDD = 3.0V, CE = 3.0V, PWM = 3.0V, FB = 3.0V, EXT1,2 = OPEN, MODE = 3.0V, VIN=4.2V

- Notes
- 1) Please be careful not to exceed the breakdown voltage level of the peripheral parts.
  - 2)  $EFFI = \left\{ \frac{(\text{Output voltage}) \times (\text{Output current})}{(\text{Input voltage}) \times (\text{Input Current})} \right\} \times 100$
  - 3) Tr1 : CPH3308 (SANYO)  
 Tr2 : CPH3408 (SANYO)  
 L : 22μH (SUMIDA CDRH125)  
 CL : 16V, 47μF x 2 (NICHICEMI Tantalum MCE Series)  
 CIN : 16V, 47μF (NICHICEMI Tantalum MCE Series)  
 RFB1 : 200kΩ  
 RFB2 : 75kΩ  
 CFB : 62pF

## ■ OPERATIONAL DESCRIPTION

The XC9210 series are 2 channel step-down DC/DC converter controller ICs with built-in high speed, low ON resistance drivers.

### <Error Amp>

The Error Amplifier is designed to monitor the output voltage and it compares the feedback voltage (FB) with the reference voltage. In response to feedback of a voltage lower than the reference voltage, the output voltage of the error amp. decreases.

### <OSC Generator>

This circuit generates the oscillation frequency which in turn generates the source clock.

### <Ramp Wave Generator>

The Ramp Wave Generator generates a saw-tooth waveform based on outputs from the Phase Shift Generator.

### <PWM Comparator>

The PWM Comparator compares outputs from the Error Amp. and saw-tooth waveform. When the voltage from the Error Amp's output is low, the external switch will be set to ON.

### <PWM/PFM Controller>

This circuit generates PFM pulses.

Control can be switched between PWM control and PWM/PFM automatic switching control using external signals.

The PWM/PFM automatic switching mode is selected when the voltage of the PWM pin is less than 0.2V, and the control switches between PWM and PFM automatically depending on the load. As the PFM circuit generates pulses based on outputs from the PWM comparator, shifting between modes occurs smoothly. PWM control mode is selected when the voltage of the PWM pin is more than 0.65V. Noise is easily reduced with PWM control since the switching frequency is fixed.

Control suited to the application can easily be selected which is useful in audio applications, for example, where traditionally, efficiencies have been sacrificed during stand-by as a result of using PWM control (due to the noise problems associated with the PFM mode in stand-by).

### <Synchronous, blank logic>

The Synchronous, blank logic circuit is to prevent penetration of the transistor connected to EXT1 and EXT2. Synchronous can be switched between Synchronous rectification and Non-Synchronous rectification automatically by using external signals. When the MODE pin's voltage is 0.2V or less, the mode will be non-synchronous rectification and operations will recommence. The EXT2 pin will be kept at a lowlevel (the external N-type MOSFET will be OFF). When the MODE pin's and PWM pin's voltage is 0.65V or more, the mode will be synchronous rectification and operations will recommence.

### <Vref with Soft Start>

The reference voltage, Vref (FB pin voltage)=0.9V, is adjusted and fixed by laser trimming (for output voltage settings, please refer to page 8). To protect against inrush current, when the power is switched on, and also to protect against voltage overshoot, soft-start time is set internally to 10ms. It should be noted, however, that this circuit does not protect the load capacitor (CL) from inrush current. With the Vref voltage limited and depending upon the input to the error amps, the operation maintains a balance between the two inputs of the error amps and controls the EXT pin's ON time so that it doesn't increase more than is necessary.

### <Chip Enable Function>

This function controls the operation and shutdown of the IC. When the voltage of the CE pin is 0.2V or less, the mode will be chip disable, the channel's operations will stop. The EXT1 pin will be kept at a highlevel (the external P-type MOSFET will be OFF) and the EXT2 pin will be kept at a lowlevel (the external N-type MOSFET will be OFF). When CE pin is in a state of chip disable, current consumption will be no more than 3.0 $\mu$ A.

When the CE pin's voltage is 0.65V or more, the mode will be chip enable and operations will recommence. With soft-start, 95% of the set output voltage will be reached within 10mS (TYP) from the moment of chip enable.

### ■ HOW TO USE

#### <Setting of Output Voltage>

Output voltage can be set by adding external split resistors. Output voltage is determined by the following equation, based on the values of RFB11(RFB21) and RFB12(RFB22). The sum of RFB11(RFB21) and RFB12(RFB22) should normally be 1 MΩ or less.

$$V_{OUT} = 0.9 \times (R_{FB11} + R_{FB12}) / R_{FB12}$$

The value of CFB1(CFB2), speed-up capacitor for phase compensation, should be  $f_{zb} = 1 / (2 \times \pi \times C_{FB1} \times R_{FB11})$  which is equal to 12kHz. Adjustments are required from 1kHz to 50kHz depending on the application, value of inductance (L), and value of load capacity (CL).

[Example of Calculation]

When RFB11 = 200kΩ and RFB12 = 75kΩ,  $V_{OUT1} = 0.9 \times (200k + 75k) / 75k = 3.3V$ .

[Typical Example]

VOUT (V)	RFB11 (kΩ)	RFB12 (kΩ)	CFB1 (pF)	VOUT (V)	RFB11 (kΩ)	RFB12 (kΩ)	CFB1 (pF)
1.2	110	330	100	2.5	390	220	33
1.5	220	330	62	2.7	360	180	33
1.8	220	220	62	3.0	560	240	24
2.0	330	270	39	3.3	200	75	62
2.2	390	270	33	5.0	82	18	160

[External Components]

Transistor :

- Low Input Voltage ( $2.0V \leq V_{IN} \leq 5.0V$ ,  $I_{OUT} \leq 2A$ )

EXT1: CPH6315 (Pch MOSFET : SANYO), IRLMS6702 (Pch MOSFET : IR)

EXT2: CPH3409 (Nch MOSFET : SANYO), IRLMS1902 (Pch MOSFET : IR)

- High Input Voltage ( $5.0V \leq V_{IN} \leq 10.0V$ ,  $I_{OUT} \leq 2A$ )

EXT1: CPH3308 (Pch MOSFET : SANYO), IRLMS5703 (Pch MOSFET : IR)

EXT2: CPH3408 (Nch MOSFET : SANYO), IRLMS1503 (Pch MOSFET : IR)

L : 22μH (SUMIDA CDRH125)      CIN : 16V, 47μF (NICHICHEMI Tantalum MCE Series)  
 CL : 16V, 47μF x 2 (NICHICHEMI Tantalum MCE Series)      SD : CMS02 (TOSHIBA, Schottky Barrier Diode)

### ■ EXTERNAL COMPONENTS

#### ○ COIL

PART NUMBER	MANUFACTURER	L VALUE (μH)	SERIAL RESISTANCE (Ω)	RATED CURRENT (A)	W x L (mm)	H (mm)
CDR125-220	SUMIDA	22	36m	2.8	12.3 x 12.3	6.0

#### ○ INPUT / OUTPUT CAPACITANCE

PART NUMBER	MANUFACTURER	VOLTAGE (V)	CAPACITANCE (μF)	W x L (mm)	H (mm)
16MCE476MD2	NICHICHEMI	16.0	47	4.6 x 5.8	3.2±0.2

#### ○ SCHOTTKY BARRIER DIODE

PART NUMBER	MANUFACTURER	REVERSE CURRENT	FORWARD CURRENT	Vfmax (V)	Irrmax (A)	W x L (mm)	H (mm)
CMS02	TOSHIBA	30	3	0.4 (IF=3A)	0.5m (VR=30V)	2.4 x 4.7	0.98±0.1

#### ○ TRANSISTOR (Pch MOSFET)

PART NUMBER	MANUFACTURER	ABSOLUTE MAX. RATINGS			Rds (ON) MAX.(mΩ)	Ciss typ (pF)	VGS (off) (V)	PKG.
		VDSS (V)	VGSS (V)	ID (A)				
CPH6315	SANYO	- 20	±10	- 3	150 (VDS= - 4.0V)	410 (VDC= - 10V)	- 1.4 (MAX.)	CPH6
CPH3308	SANYO	- 30	±20	- 4	140 (VDS= - 4.0V)	560 (VDC= - 10V)	- 2.4 (MAX.)	CPH3
IRLMS6702	IR	- 20	±12	- 2.3	200 (VDS= - 4.5V)	210 (VDC= - 15V)	- 0.7 (MAX.)	Micro6
IRLMS5703	IR	- 30	±20	- 2.3	400 (VDS= - 4.5V)	170 (VDC= - 25V)	- 1.0 (MAX.)	Micro6

#### ○ TRANSISTOR (Nch MOSFET)

PART NUMBER	MANUFACTURER	ABSOLUTE MAX. RATINGS			Rds (ON) MAX.(mΩ)	Ciss typ (pF)	VGS (off) (V)	PKG.
		VDSS (V)	VGSS (V)	ID (A)				
CPH3409	SANYO	30	±10	5	42 (VDS=4.0V)	630 (VDC= 10V)	1.3 (MAX.)	CPH6
CHP3408	SANYO	30	±20	5	68 (VDS=4.0V)	480 (VDC= 10V)	2.4 (MAX.)	CPH3
IRLMS1902	IR	20	±12	3.2	100 (VDS=4.5V)	300 (VDC= 15V)	0.7 (MAX.)	Micro6
IRLMS1503	IR	30	±20	3.2	200 (VDS=4.5V)	210 (VDC= 25V)	1.0 (MAX.)	Micro6

## TEST CIRCUITS

Circuit 1

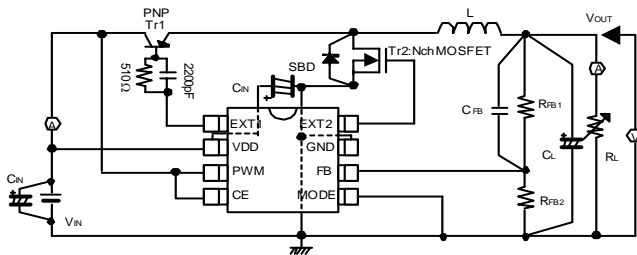

Circuit 2

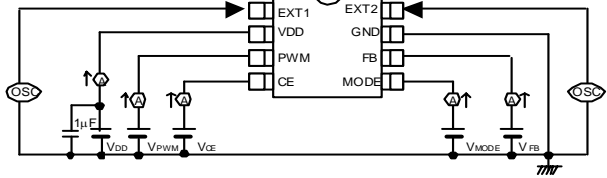

Circuit 3

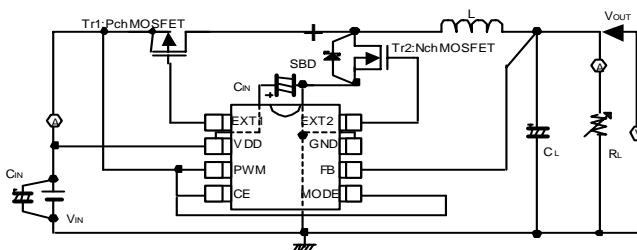

Circuit 4

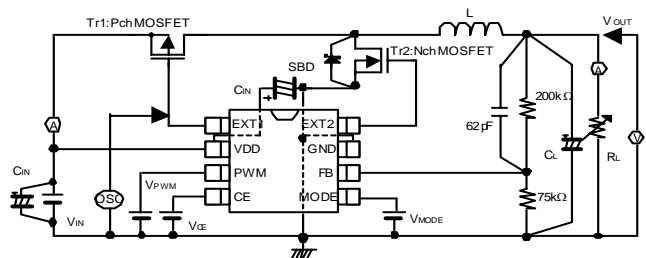

Circuit 5

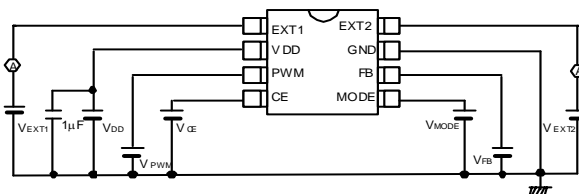

### Circuit 1 :

- L: 22µH (SUMIDA CDRH125)
- CL: 16MCE476MD2 (NIHONCHEMICON, Tantalum Type)
- CIN: 16MCE476MD2 (NIHONCHEMICON, Tantalum Type)
- PNP Tr 1 : 2SA1213 (TOSHIBA)
- Tr 2 : CPH3409 (SANYO)
- RFB : Please use by the conditions as below.
- RFB1 + RFB2 ≤ 1MΩ
- RFB1 / RFB2 = (Setting Output Voltage / 0.9) - 1
- CFB :  $f_{ztb} = 1 / (2 \times \pi \times CFB \times RFB1) = 1\text{kHz} \sim 50\text{kHz}$  (12kHz usual)

### Circuit 2 :

- L: 22µH (SUMIDA CDRH125)
- CL: 16MCE476MD2 (NIHONCHEMICON, Tantalum Type)
- CIN: 16MCE476MD2 (NIHONCHEMICON, Tantalum Type)
- Tr 1 : CPH6315 (SANYO)
- Tr 2 : CPH3409 (SANYO)

### Circuit 1 :

- L: 22µH (SUMIDA CDRH125)
- CL: 16MCE476MD2 (NIHONCHEMICON, Tantalum Type)
- CIN: 16MCE476MD2 (NIHONCHEMICON, Tantalum Type)
- Tr 1 : CPH3308 (SANYO)
- Tr 2 : CPH3409 (SANYO)



## ■ NOTES ON USE

### 1. Checking for Intermittent Oscillation

The XC9210 series is subject to intermittent oscillation in the proximity of the maximum duty if the step-down ratio is low (e.g., from 4.2 V to 3.3 V) or a heavy load is applied where the duty ratio becomes high. Check waveforms at EXT under your operating conditions. A remedy for this problem is to raise the inductance of coil L or increase the load capacitance CL and use OS-CON for the load capacitance CL. When using OS-CON for the load capacitance and setting output voltage low, the series could produce an abnormal oscillation. In such case, please test with the actual device.

### 2. PWM/PFM Automatic Switching

If PWM/PFM automatic switching control is selected and the step-down ratio is high (e.g., from 10 V to 1.0 V), the control mode remains in PFM setting over the whole load range, since the duty ratio under continuous-duty condition is smaller than the PFM duty ratio of the XC9210 series. The output voltage's ripple voltage becomes substantially high under heavy load conditions, with the XC9210 series appearing to be producing an abnormal oscillation. If this operation becomes a concern, set pins PWM1 and PWM2 to High to set the control mode to PWM setting. For use under the above-mentioned condition, measured data of PWM/PFM automatic switching control shown on the data sheets are available up to IOUT = 100 mA.

### 3. Ratings

Use the XC9210 series and peripheral components within the limits of their ratings.

### 4. Reverse Current

Reverse current is produced under the conditions of synchronous operation and light load (current flows from the output to the input). If this reverse current becomes a concern, operate under synchronous rectification during heavy load conditions, or move input capacitance CIN closer to the IC to reduce the reverse current to the power supply.

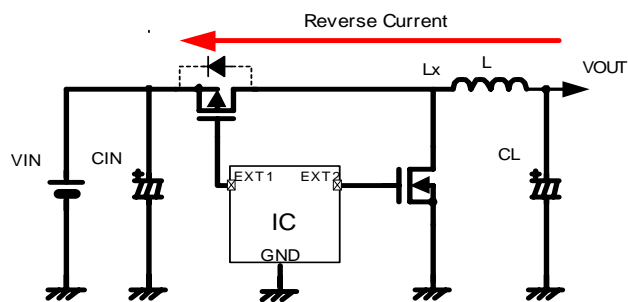

\* The light load condition mentioned above means that the load current when the coil current being discontinuous at non-synchronous operation. The heavy load condition means that the load current when the coil current being continuous at non-synchronous operation. The DC/DC simulation on the TOREX website is useful to determine whether the coil current is non-synchronous or synchronous under your operating conditions. After the simulation, please test with the actual device.

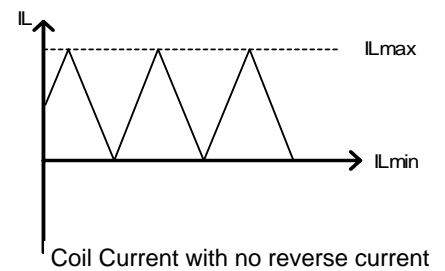
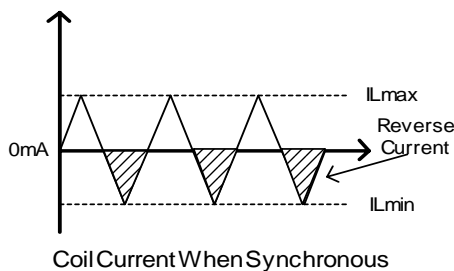
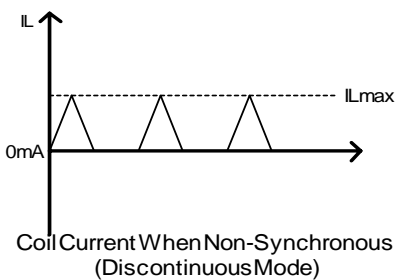

Comparison among non-synchronous operation (left), synchronous operation (center) and the coil current on a like-for-like basis. Synchronous of the current  $I_{Lmin} < 0mA$  becomes reverse current. To prevent the reverse current, operate in the condition of  $I_{Lmin} > 0mA$  (right).

### 5. Switching Method of Operational Mode / Control

PWM	MODE	OPERATIONAL MODE / CONTROL
'H'	'H'	Synchronous, PWM Control
'H'	'L'	Non-Synchronous, PWM Control
'L'	'H'	Non-Synchronous, PFM / PWM Automatic Switching Control
'L'	'L'	Non-Synchronous, PFM / PWM Automatic Switching Control

## 6. Notes on How to Select Transistor

Synchronous rectification operation prepares fixed time when switching changes so that the high side PchMOSFET and the low side NchMOSFET do not oscillate simultaneously. Also it is designed to prevent the penetration current when the both MOSFET oscillate at the same time. However, some MOSFET may oscillate simultaneously and worsen efficiency. Please select MOSFET with high  $V_{th}$  with small input capacity on high side PchMOSFET and the low side NchMOSFET. (When using with large current, please note that there is a tendency for ON resistance to become large when the input capacity of MOSFET is small and  $V_{th}$  is high.)

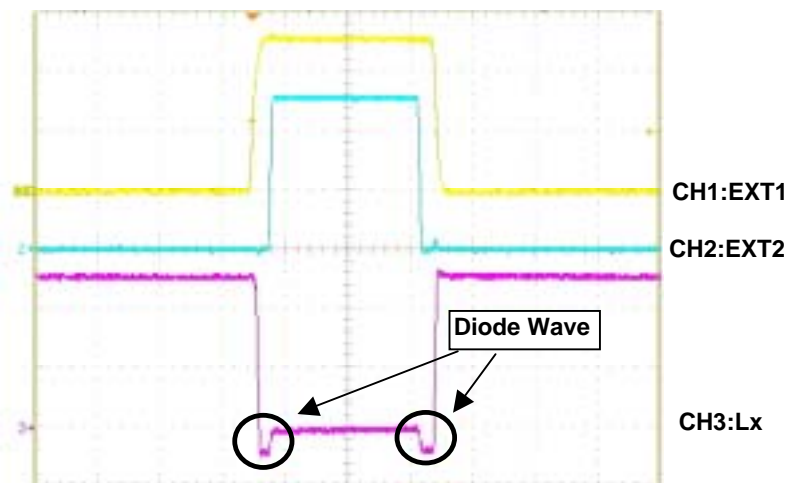

## ■ TYPICAL APPLICATION CIRCUIT

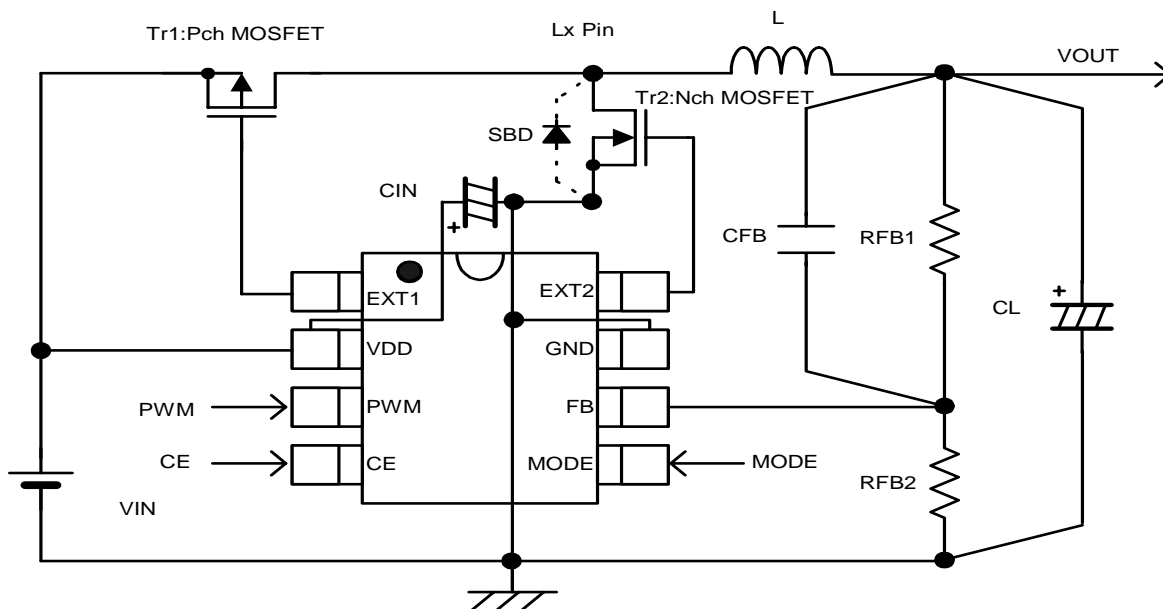

## TYPICAL PERFORMANCE CHARACTERISTICS

### (1) Output Voltage vs. Output Current

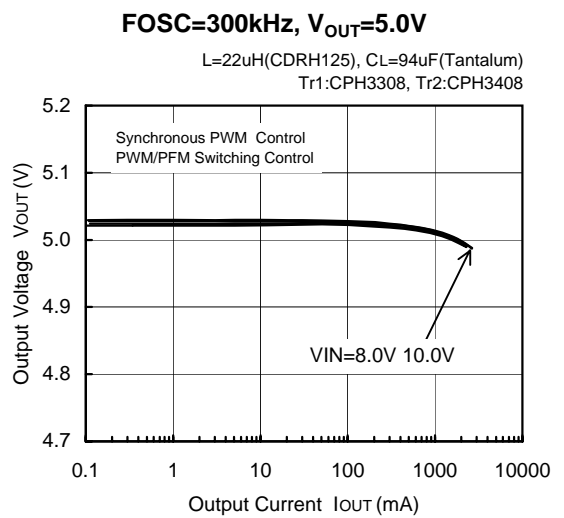
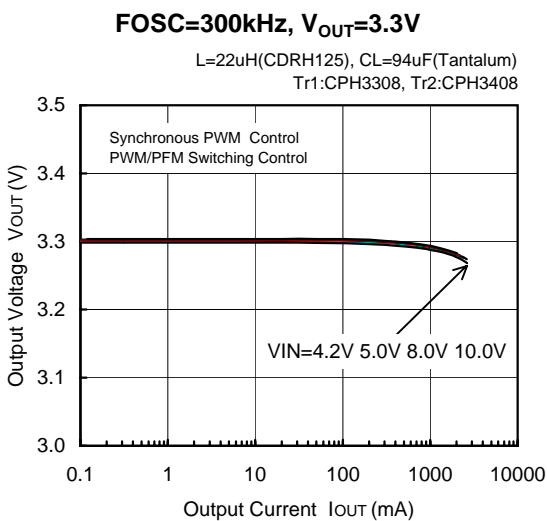
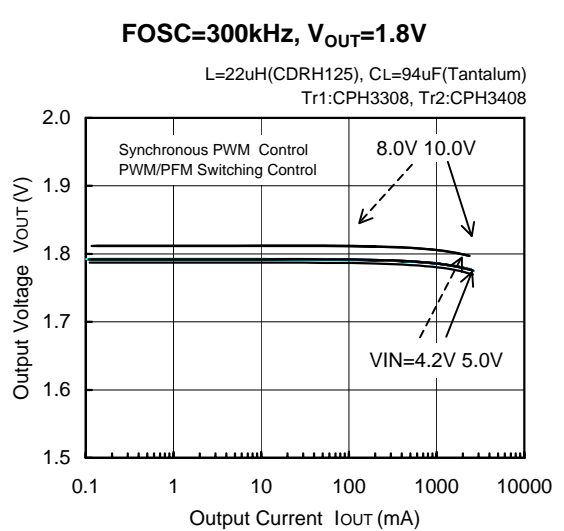
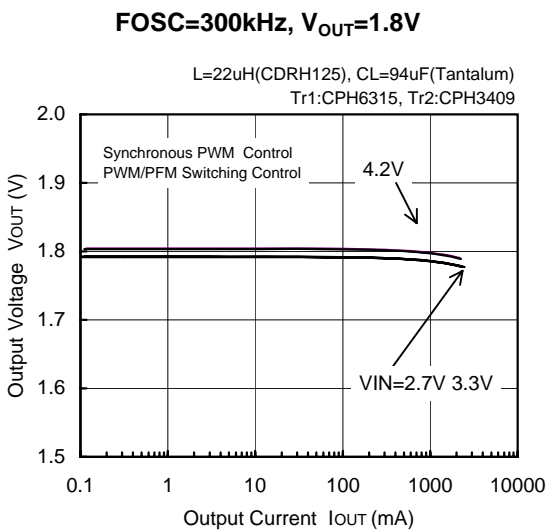
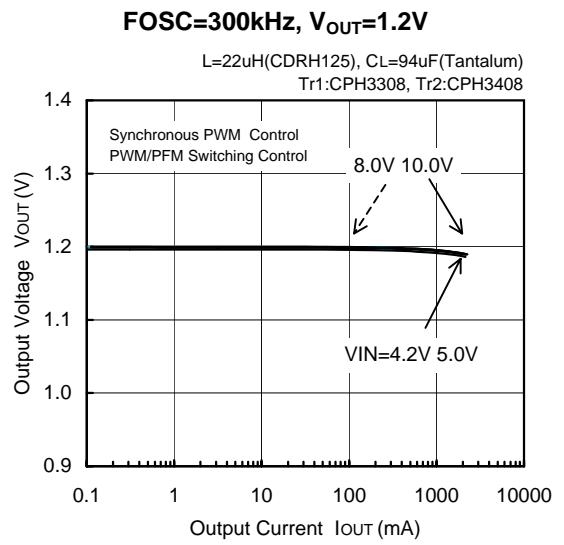
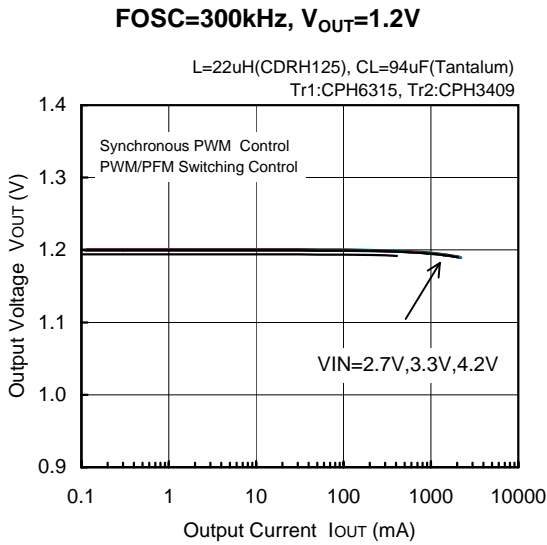

\* Dotted arrow ----> PWM/PFM Switching Control Only

(1) Output Voltage vs. Output Current (Continued)

**FOSC=300kHz, V<sub>OUT</sub>=1.2V**

L=22uH(CDRH125), CL=94uF(Tantalum)  
Tr1:IRLMS6702, Tr2:IRLMS1902

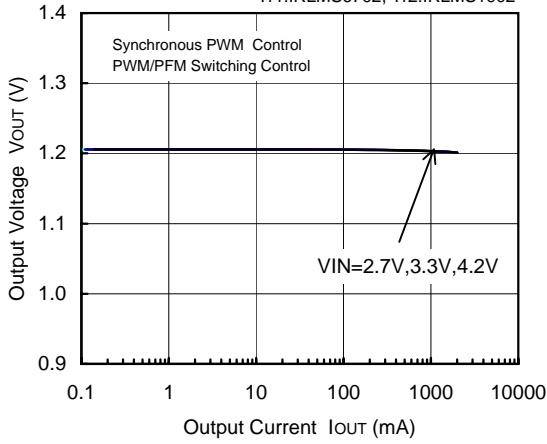

**FOSC=300kHz, V<sub>OUT</sub>=5.0V**

L=22uH(CDRH125), CL=94uF(Tantalum)  
Tr1:IRLMS5703, Tr2:IRLMS1503

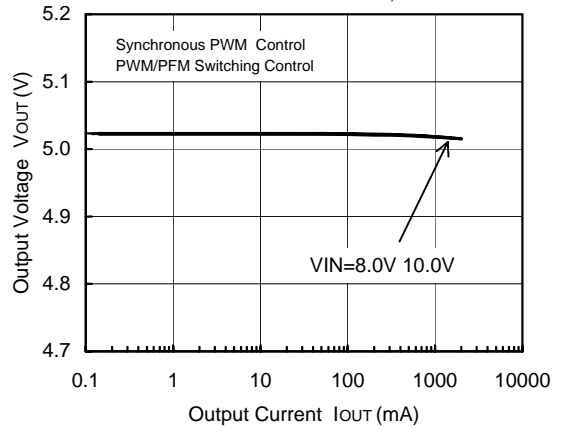

**FOSC=180kHz, V<sub>OUT</sub>=1.2V**

L=22uH(CDRH125), CL=94uF(Tantalum)  
Tr1:CPH6315, Tr2:CPH3409

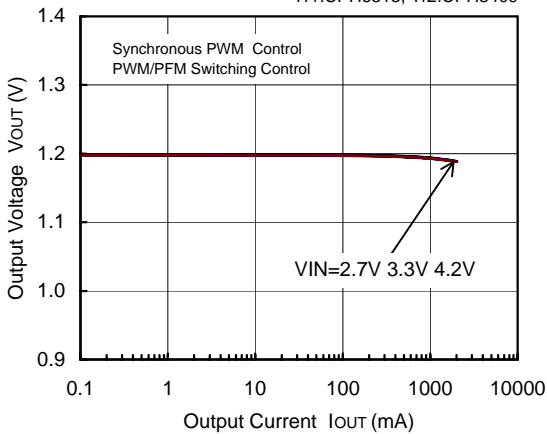

**FOSC=180kHz, V<sub>OUT</sub>=1.2V**

L=22uH(CDRH125), CL=94uF(Tantalum)  
Tr1:CPH3308, Tr2:CPH3408

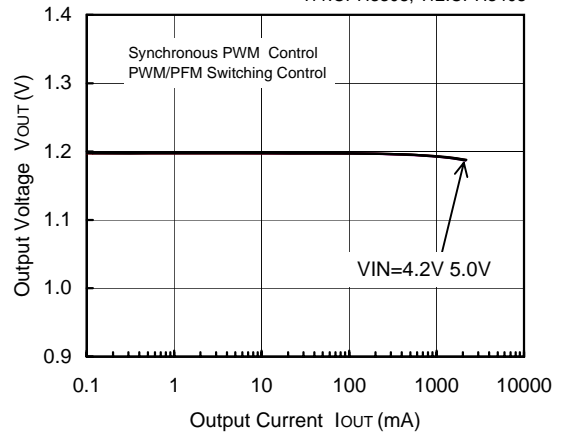

**FOSC=180kHz, V<sub>OUT</sub>=1.8V**

L=22uH(CDRH125), CL=94uF(Tantalum)  
Tr1:CPH6315, Tr2:CPH3409

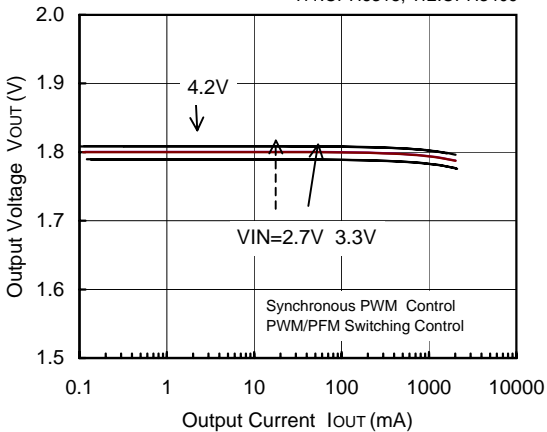

**FOSC=180kHz, V<sub>OUT</sub>=1.8V**

L=22uH(CDRH125), CL=94uF(Tantalum)  
Tr1:CPH3308, Tr2:CPH3408

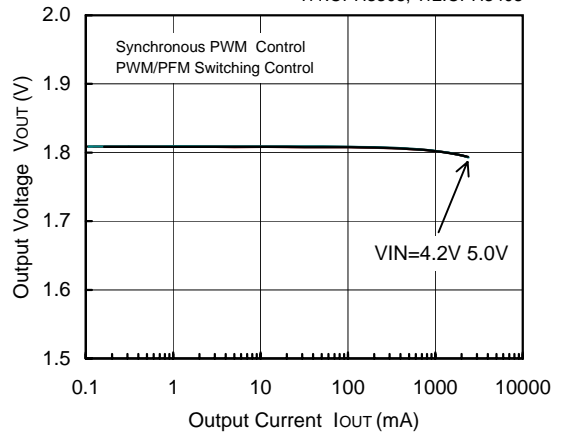

\* Dotted arrow ----> PWM/PFM Switching Control Only

### (1) Output Voltage vs. Output Current (Continued)

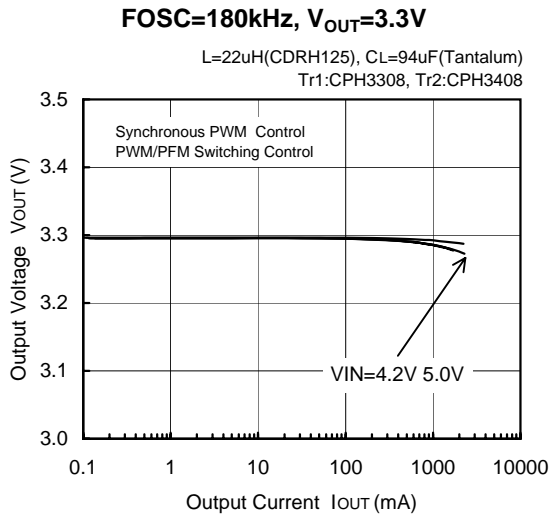

## (2) Efficiency vs. Output Current

**FOSC=300kHz, V<sub>OUT</sub>=1.2V**

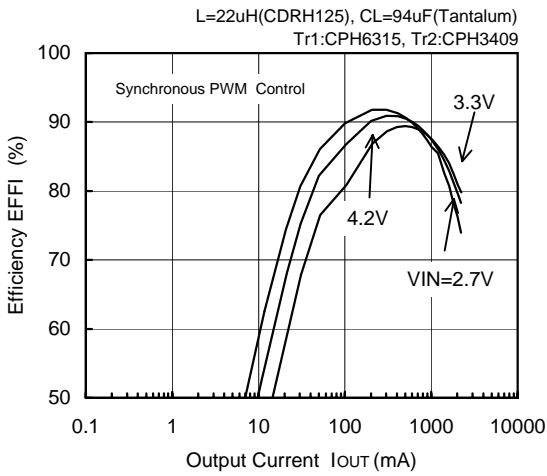

**FOSC=300kHz, V<sub>OUT</sub>=1.2V**

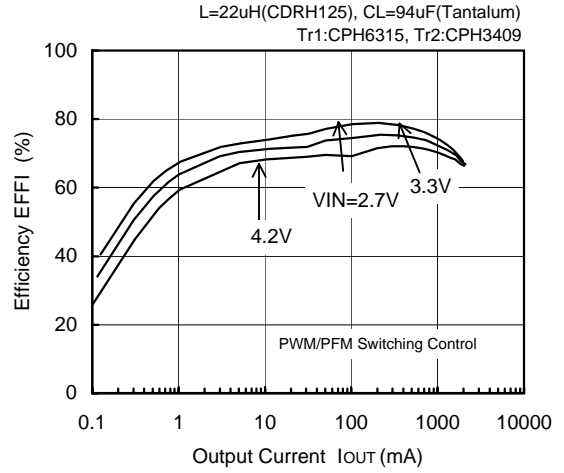

**FOSC=300kHz, V<sub>OUT</sub>=1.2V**

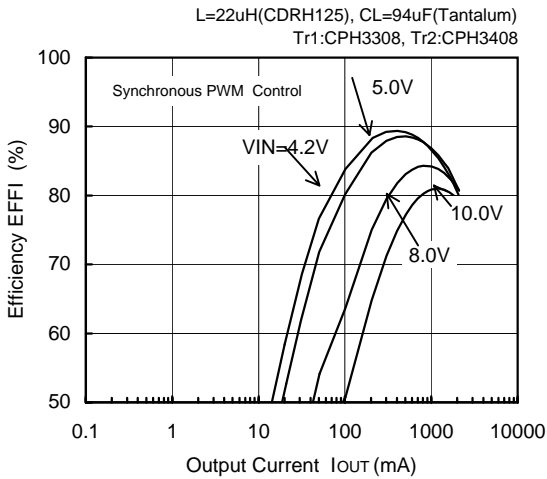

**FOSC=300kHz, V<sub>OUT</sub>=1.2V**

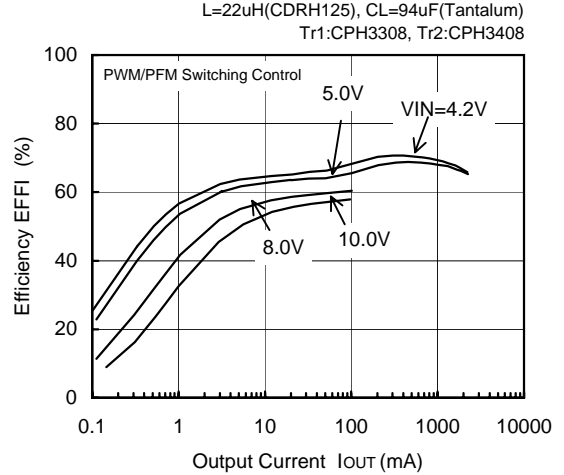

**FOSC=300kHz, V<sub>OUT</sub>=1.8V**

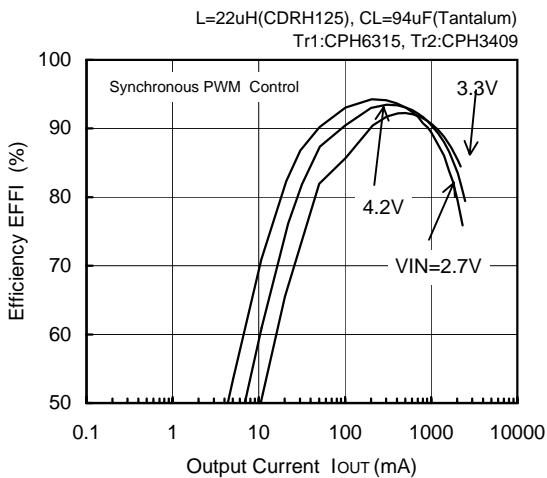

**FOSC=300kHz, V<sub>OUT</sub>=1.8V**

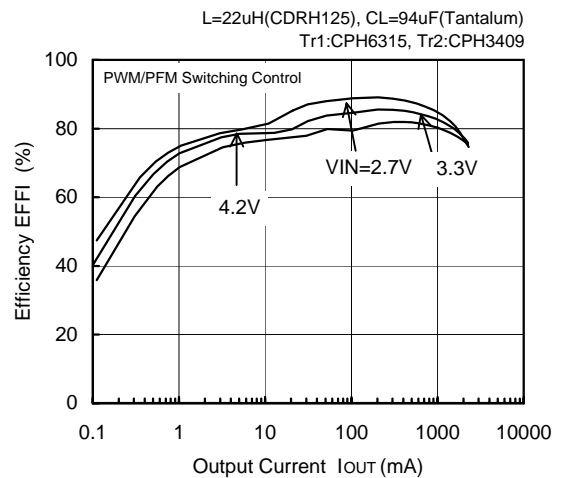

## (2) Efficiency vs. Output Current (Continued)

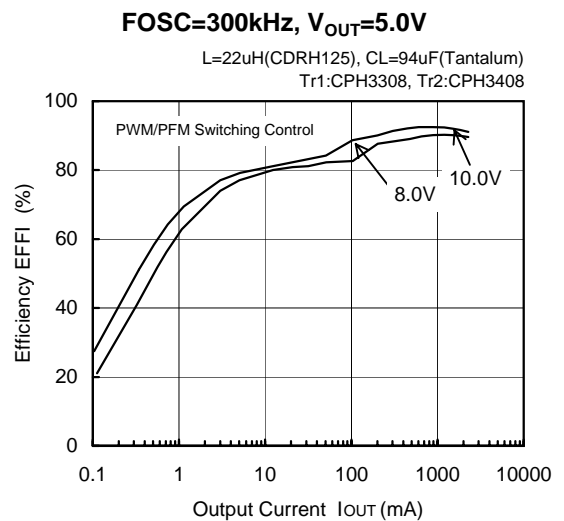
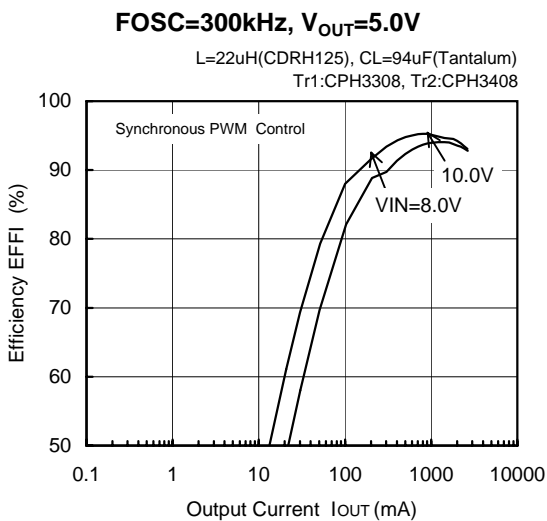
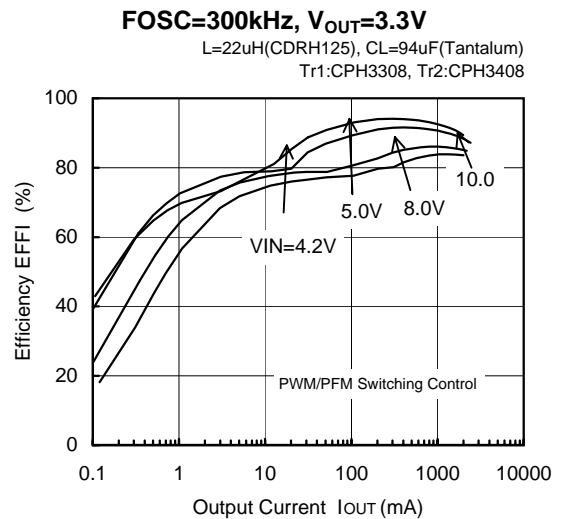
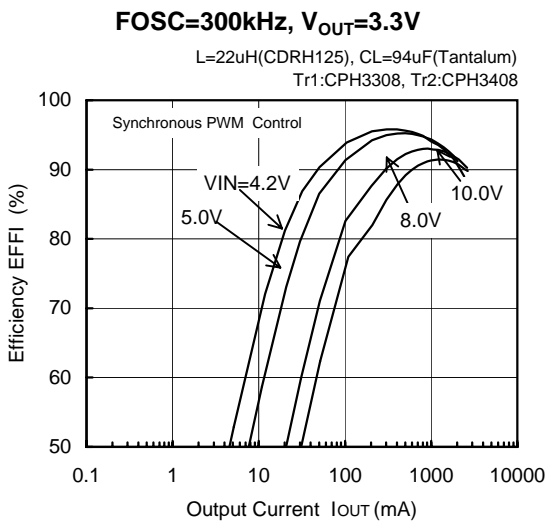
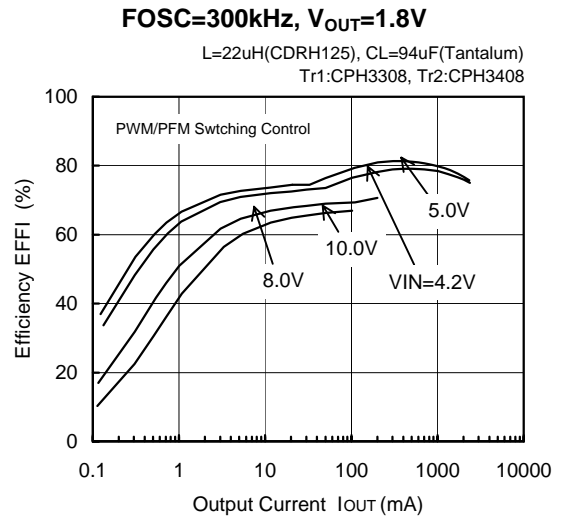
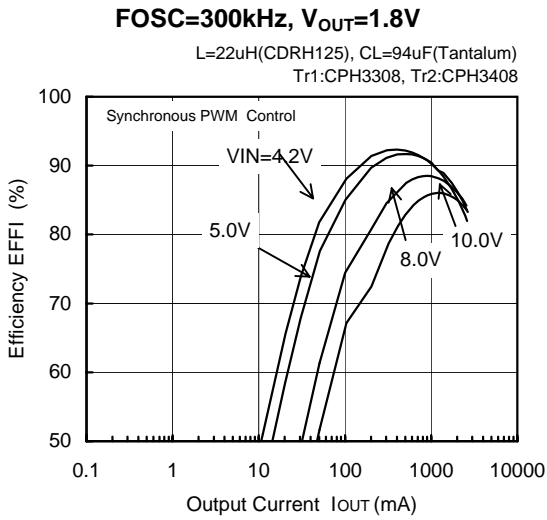

## (2) Efficiency vs. Output Current (Continued)

**FOSC=300kHz, V<sub>OUT</sub>=1.2V**

L=22uH(CDRH125), CL=94uF(Tantalum)  
Tr1:IRLMS6702, Tr2:IRLMS1902

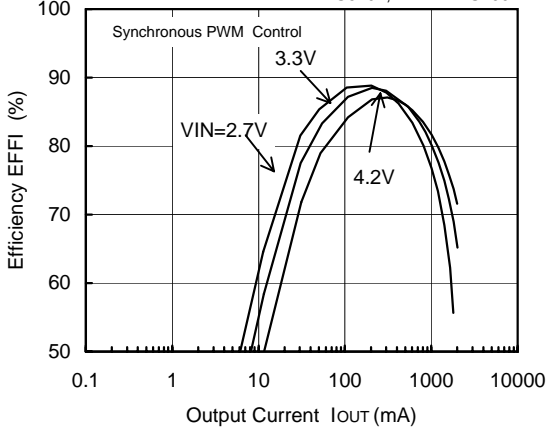

**FOSC=300kHz, V<sub>OUT</sub>=1.2V**

L=22uH(CDRH125), CL=94uF(Tantalum)  
Tr1:IRLMS6702, Tr2:IRLMS1902

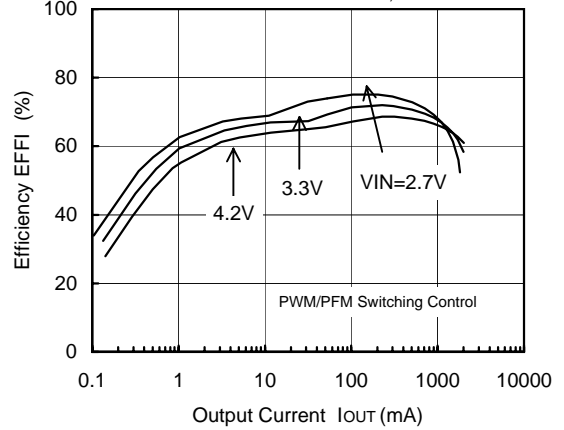

**FOSC=300kHz, V<sub>OUT</sub>=5.0V**

L=22uH(CDRH125), CL=94uF(Tantalum)  
Tr1:IRLMS5703, Tr2:IRLMS1503

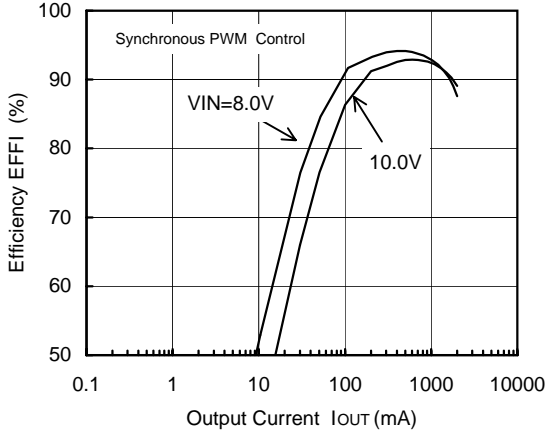

**FOSC=300kHz, V<sub>OUT</sub>=5.0V**

L=22uH(CDRH125), CL=94uF(Tantalum)  
Tr1:IRLMS5703, Tr2:IRLMS1503

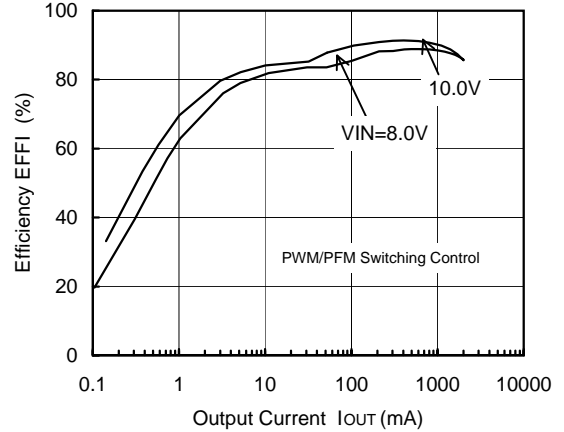

**FOSC=180kHz, V<sub>OUT</sub>=1.2V**

L=22uH(CDRH125), CL=94uF(Tantalum)  
Tr1:CPH6315, Tr2:CPH3409

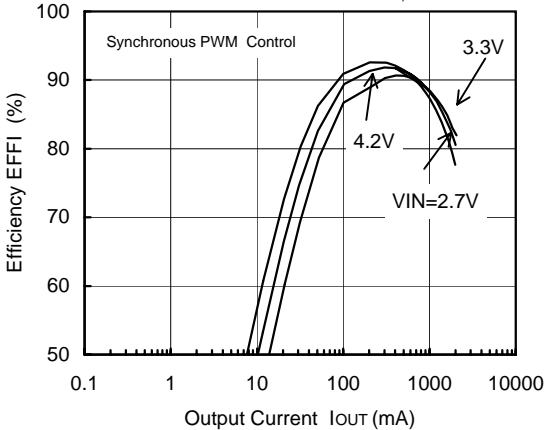

**FOSC=180kHz, V<sub>OUT</sub>=1.2V**

L=22uH(CDRH125), CL=94uF(Tantalum)  
Tr1:CPH6315, Tr2:CPH3409

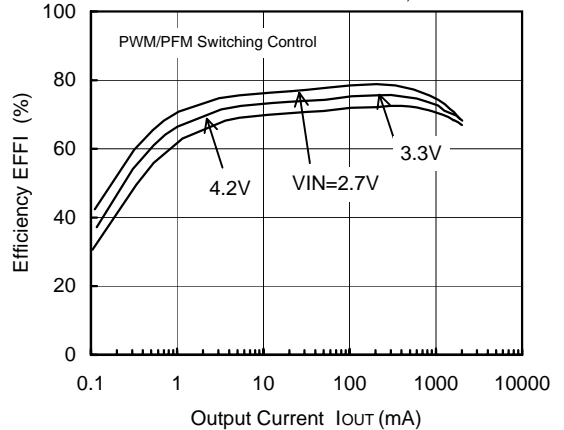



## (2) Efficiency vs. Output Current (Continued)

**FOSC=180kHz, V<sub>OUT</sub>=1.2V**

L=22uH(CDRH125), CL=94uF(Tantalum)  
Tr1:CPH3308, Tr2:CPH3408

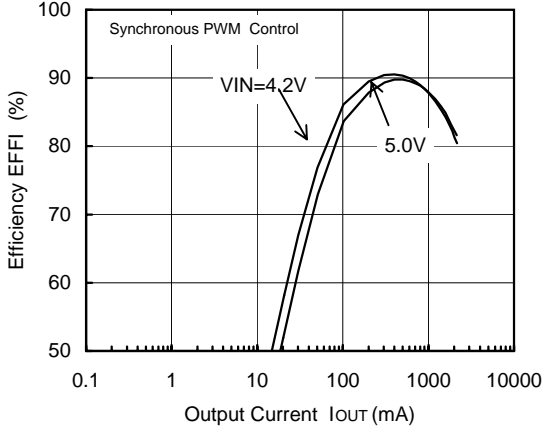

**FOSC=180kHz, V<sub>OUT</sub>=1.2V**

L=22uH(CDRH125), CL=94uF(Tantalum)  
Tr1:CPH3308, Tr2:CPH3408

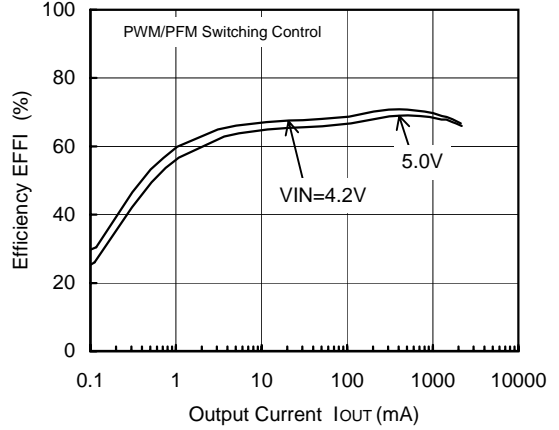

**FOSC=180kHz, V<sub>OUT</sub>=1.8V**

L=22uH(CDRH125), CL=94uF(Tantalum)  
Tr1:CPH6315, Tr2:CPH3409

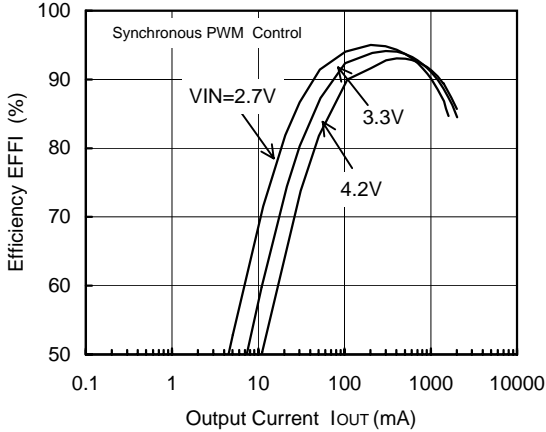

**FOSC=180kHz, V<sub>OUT</sub>=1.8V**

L=22uH(CDRH125), CL=94uF(Tantalum)  
Tr1:CPH6315, Tr2:CPH3409

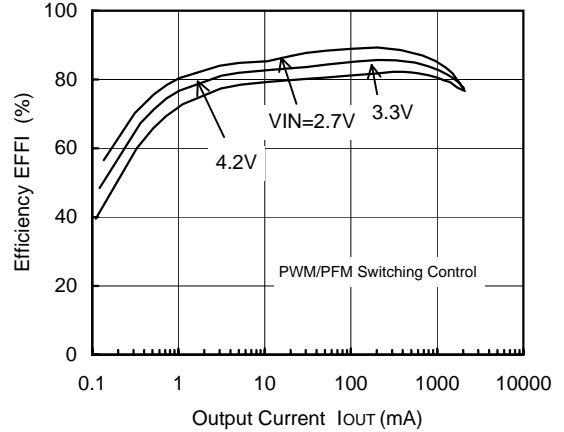

**FOSC=180kHz, V<sub>OUT</sub>=1.8V**

L=22uH(CDRH125), CL=94uF(Tantalum)  
Tr1:CPH3308, Tr2:CPH3408

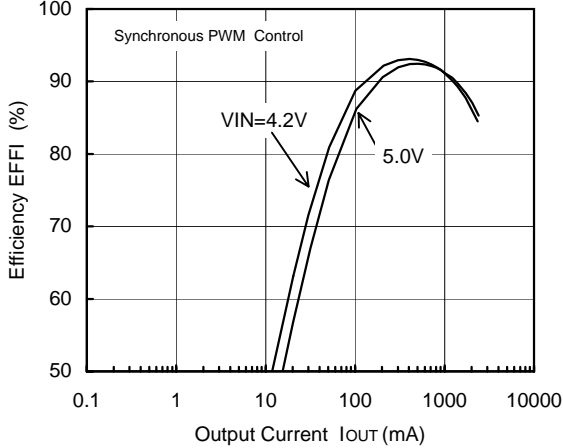

**FOSC=180kHz, V<sub>OUT</sub>=1.8V**

L=22uH(CDRH125), CL=94uF(Tantalum)  
Tr1:CPH3308, Tr2:CPH3408

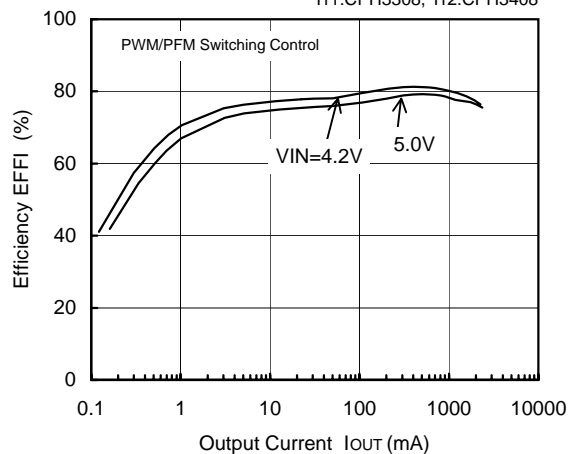

(2) Efficiency vs. Output Current (Continued)

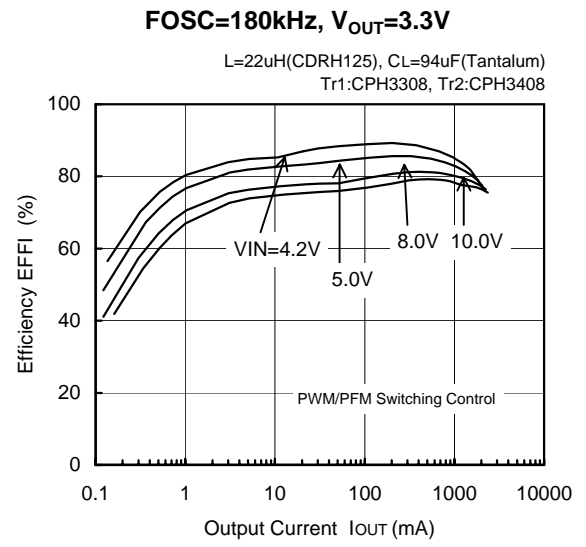
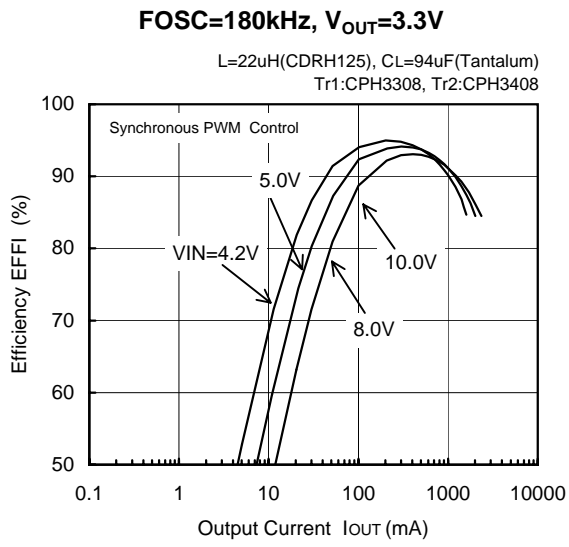

### (3) Ripple Voltage vs. Output Current

**FOSC=300kHz, V<sub>OUT</sub>=1.2V**

L=22uH(CDRH125), CL=94uF(Tantalum)  
Tr1:CPH6315, Tr2:CPH3409

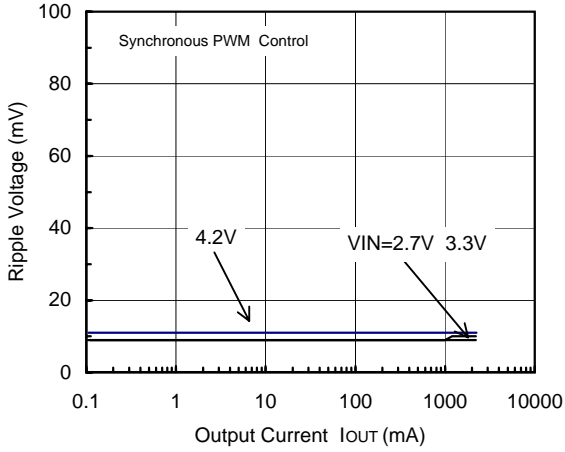

**FOSC=300kHz, V<sub>OUT</sub>=1.2V**

L=22uH(CDRH125), CL=94uF(Tantalum)  
Tr1:CPH6315, Tr2:CPH3409

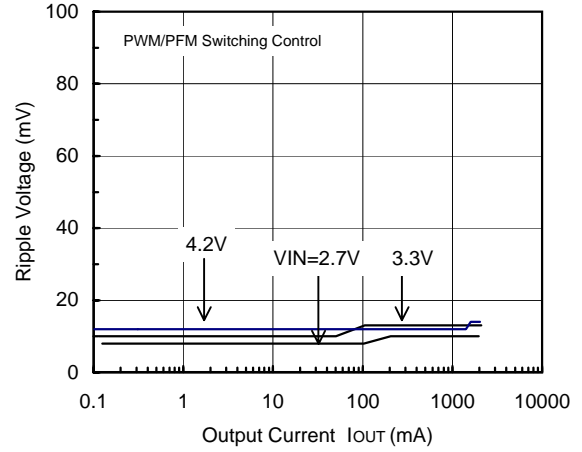

**FOSC=300kHz, V<sub>OUT</sub>=1.2V**

L=22uH(CDRH125), CL=94uF(Tantalum)  
Tr1:CPH3308, Tr2:CPH3408

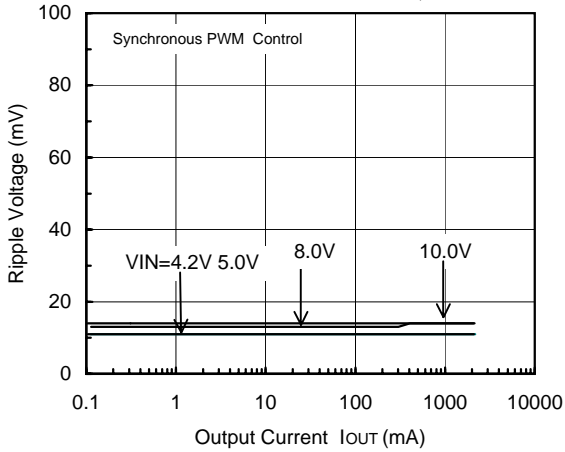

**FOSC=300kHz, V<sub>OUT</sub>=1.2V**

L=22uH(CDRH125), CL=94uF(Tantalum)  
Tr1:CPH3308, Tr2:CPH3408

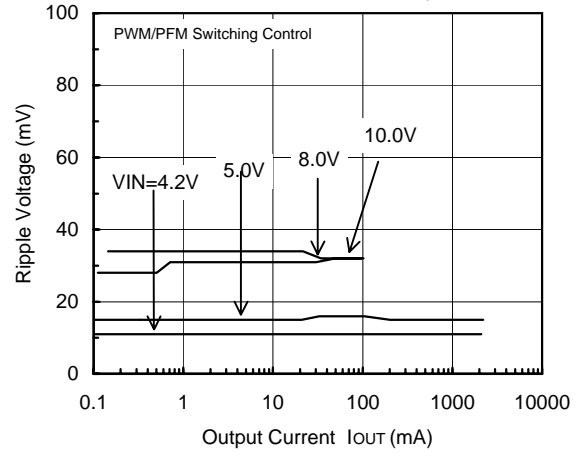

**FOSC=300kHz, V<sub>OUT</sub>=1.8V**

L=22uH(CDRH125), CL=94uF(Tantalum)  
Tr1:CPH6315, Tr2:CPH3409

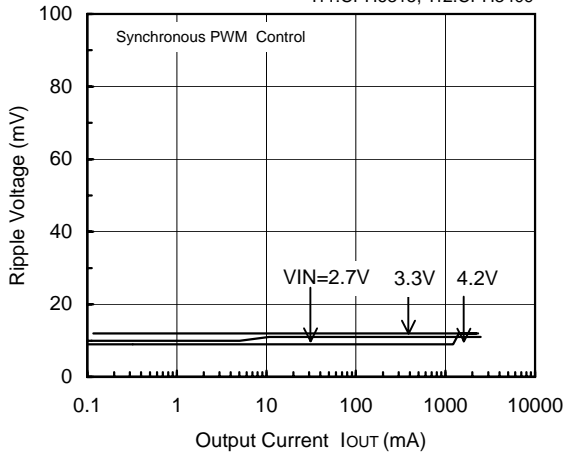

**FOSC=300kHz, V<sub>OUT</sub>=1.8V**

L=22uH(CDRH125), CL=94uF(Tantalum)  
Tr1:CPH6315, Tr2:CPH3409

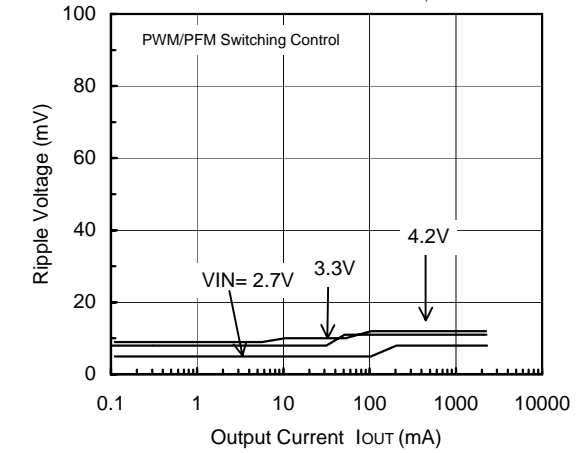

### (3) Ripple Voltage vs. Output Current (Continued)

**FOSC=300kHz, V<sub>OUT</sub>=1.8V**

L=22uH(CDRH125), CL=94uF(Tantalum)  
Tr1:CPH3308, Tr2:CPH3408

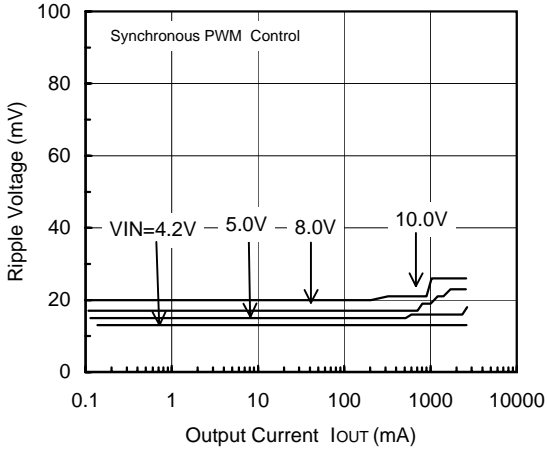

**FOSC=300kHz, V<sub>OUT</sub>=1.8V**

L=22uH(CDRH125), CL=94uF(Tantalum)  
Tr1:CPH3308, Tr2:CPH3408

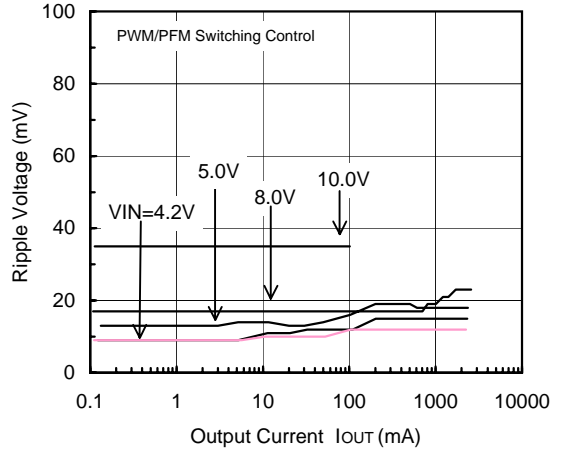

**FOSC=300kHz, V<sub>OUT</sub>=3.3V**

L=22uH(CDRH125), CL=94uF(Tantalum)  
Tr1:CPH3308, Tr2:CPH3408

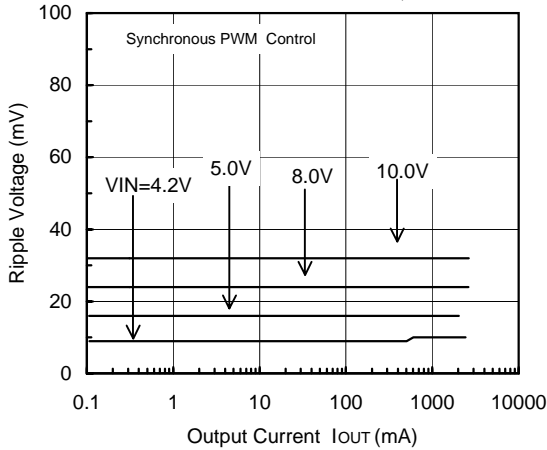

**FOSC=300kHz, V<sub>OUT</sub>=3.3V**

L=22uH(CDRH125), CL=94uF(Tantalum)  
Tr1:CPH3308, Tr2:CPH3408

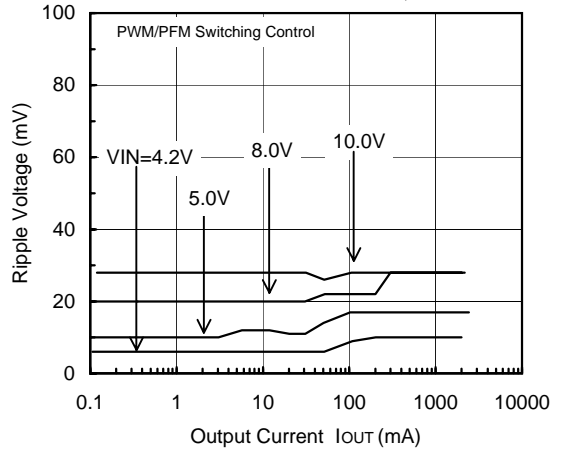

**FOSC=300kHz, V<sub>OUT</sub>=5.0V**

L=22uH(CDRH125), CL=94uF(Tantalum)  
Tr1:CPH3308, Tr2:CPH3408

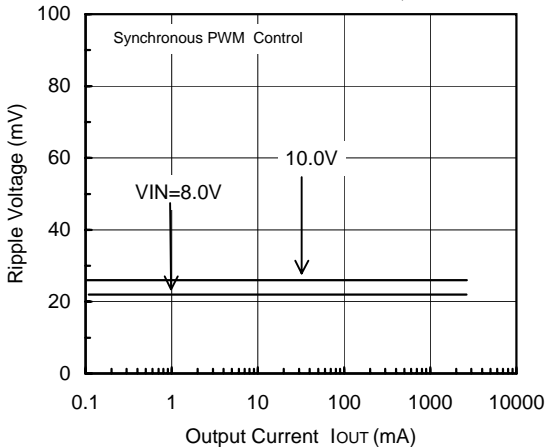

**FOSC=300kHz, V<sub>OUT</sub>=5.0V**

L=22uH(CDRH125), CL=94uF(Tantalum)  
Tr1:CPH3308, Tr2:CPH3408

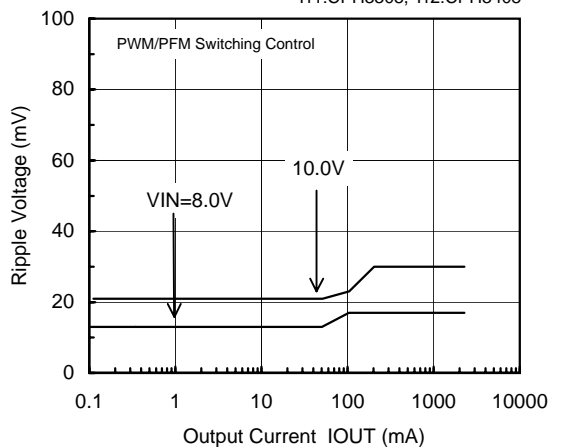

### (3) Ripple Voltage vs. Output Current (Continued)

**FOSC=300kHz, V<sub>OUT</sub>=1.2V**

L=22uH(CDRH125), CL=94uF(Tantalum)  
Tr1:IRLMS6702, Tr2:IRLMS1902

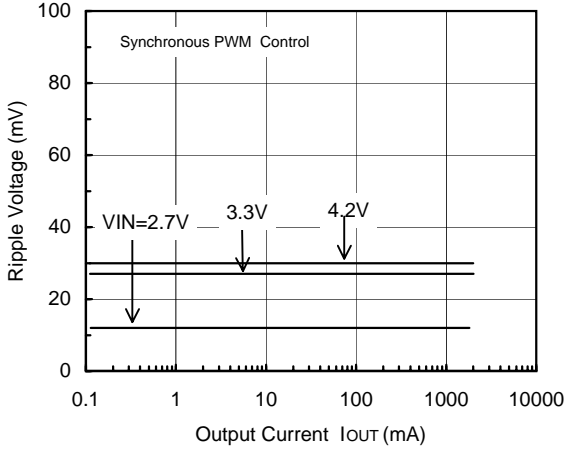

**FOSC=300kHz, V<sub>OUT</sub>=1.2V**

L=22uH(CDRH125), CL=94uF(Tantalum)  
Tr1:IRLMS6702, Tr2:IRLMS1902

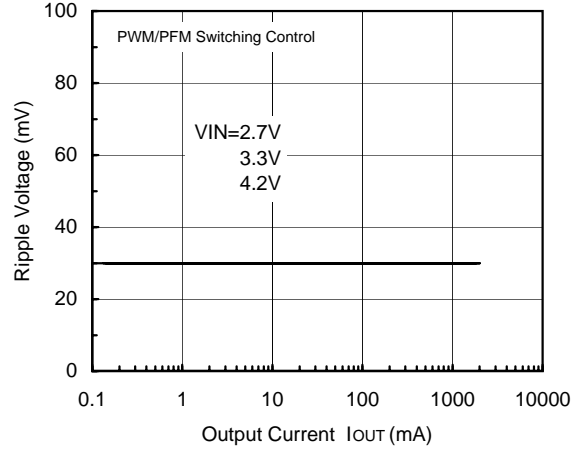

**FOSC=300kHz, V<sub>OUT</sub>=5.0V**

L=22uH(CDRH125), CL=94uF(Tantalum)  
Tr1:IRLMS5703, Tr2:IRLMS1503

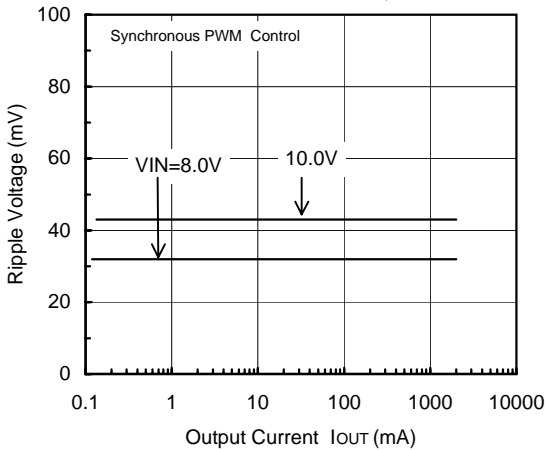

**FOSC=300kHz, V<sub>OUT</sub>=5.0V**

L=22uH(CDRH125), CL=94uF(Tantalum)  
Tr1:IRLMS5703, Tr2:IRLMS1503

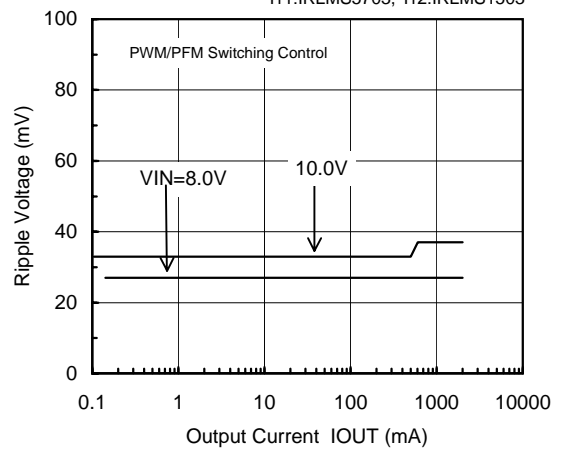

**FOSC=180kHz, V<sub>OUT</sub>=1.2V**

L=22uH(CDRH125), CL=94uF(Tantalum)  
Tr1:CPH6315, Tr2:CPH3409

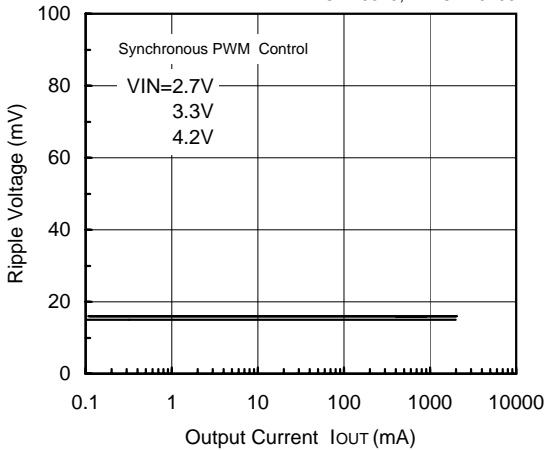

**FOSC=180kHz, V<sub>OUT</sub>=1.2V**

L=22uH(CDRH125), CL=94uF(Tantalum)  
Tr1:CPH6315, Tr2:CPH3409

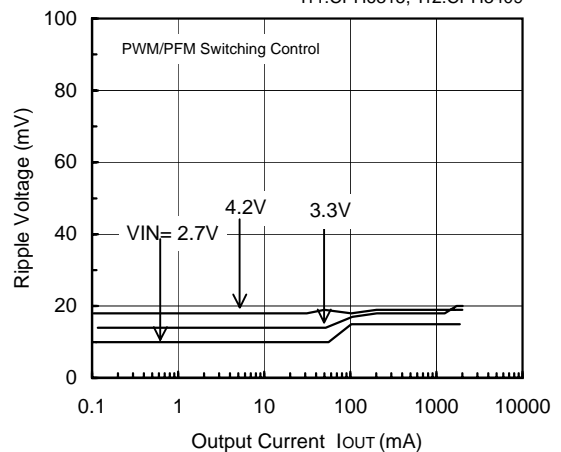

### (3) Ripple Voltage vs. Output Current (Continued)

**FOSC=180kHz, V<sub>OUT</sub>=1.2V**

L=22uH(CDRH125), CL=94uF(Tantalum)  
Tr1:CPH3308, Tr2:CPH3408

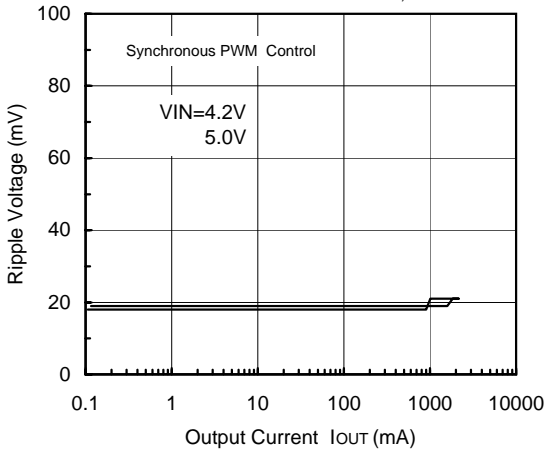

**FOSC=180kHz, V<sub>OUT</sub>=1.2V**

L=22uH(CDRH125), CL=94uF(Tantalum)  
Tr1:CPH3308, Tr2:CPH3408

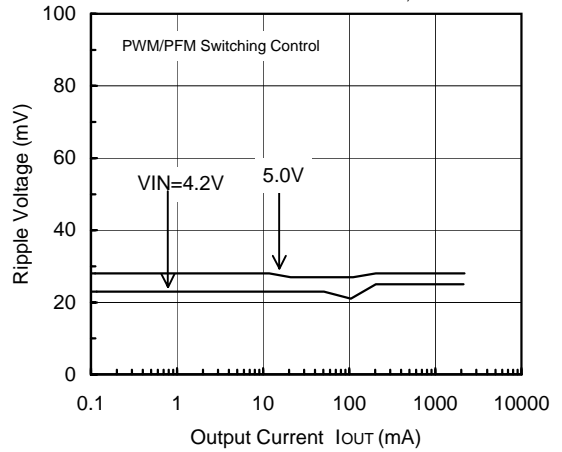

**FOSC=180kHz, V<sub>OUT</sub>=1.8V**

L=22uH(CDRH125), CL=94uF(Tantalum)  
Tr1:CPH6315, Tr2:CPH3409

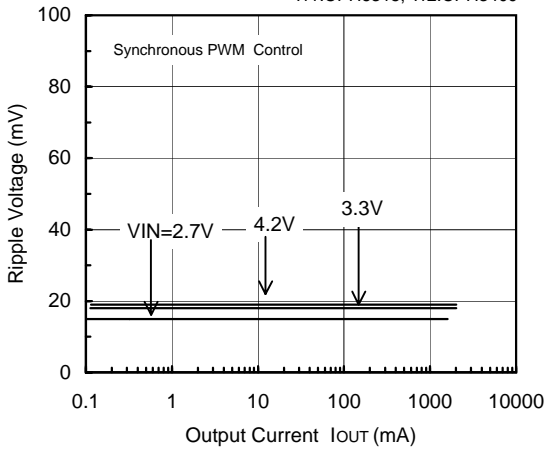

**FOSC=180kHz, V<sub>OUT</sub>=1.8V**

L=22uH(CDRH125), CL=94uF(Tantalum)  
Tr1:CPH6315, Tr2:CPH3409

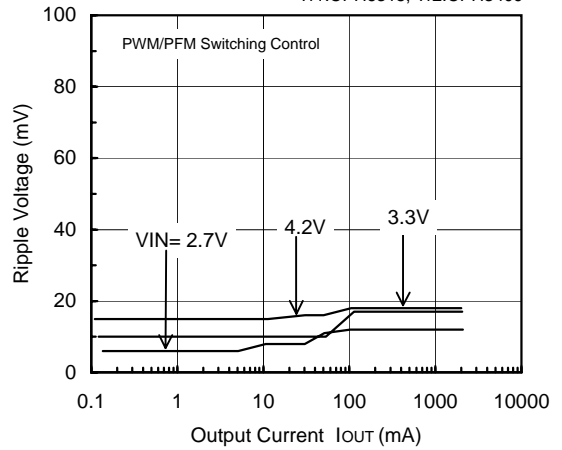

**FOSC=180kHz, V<sub>OUT</sub>=1.8V**

L=22uH(CDRH125), CL=94uF(Tantalum)  
Tr1:CPH3308, Tr2:CPH3408

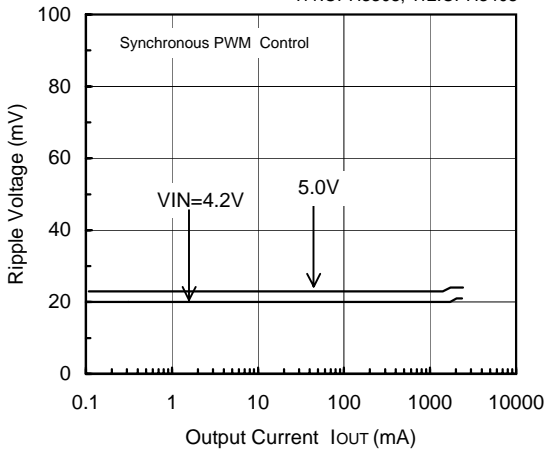

**FOSC=180kHz, V<sub>OUT</sub>=1.8V**

L=22uH(CDRH125), CL=94uF(Tantalum)  
Tr1:CPH3308, Tr2:CPH3408

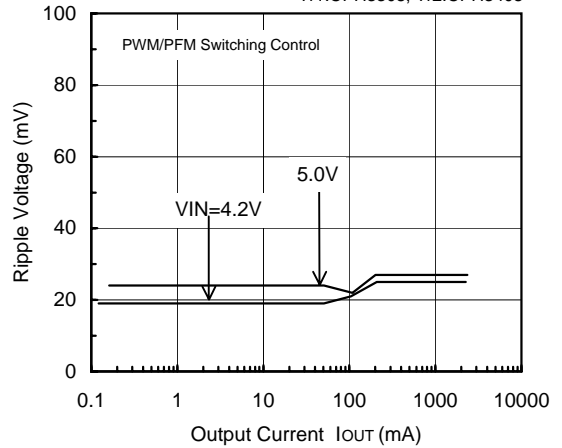

### (3) Ripple Voltage vs. Output Current (Continued)

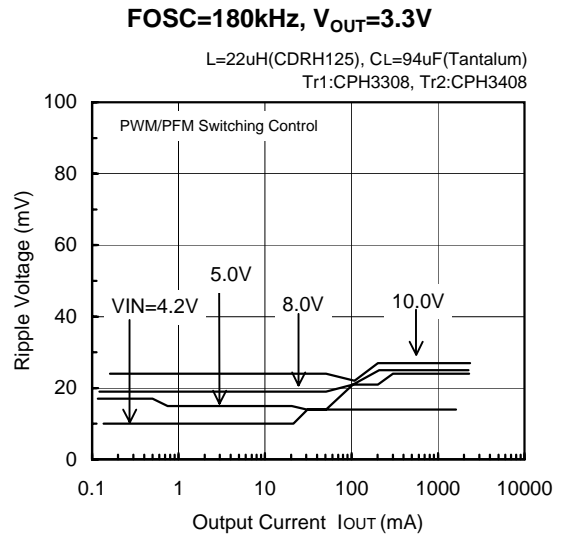
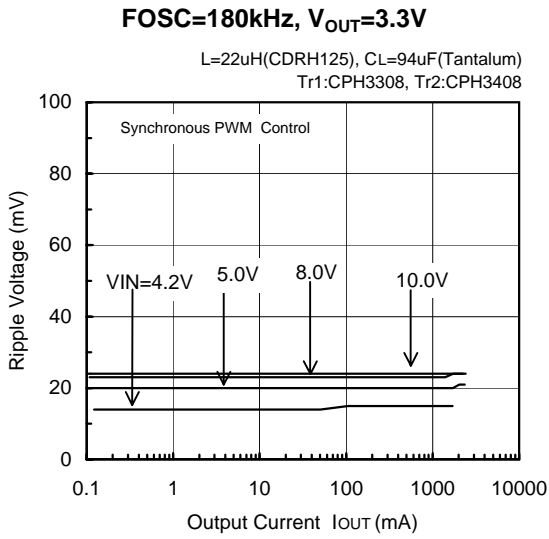

### (4) Breakdown of Coil Inductance Value

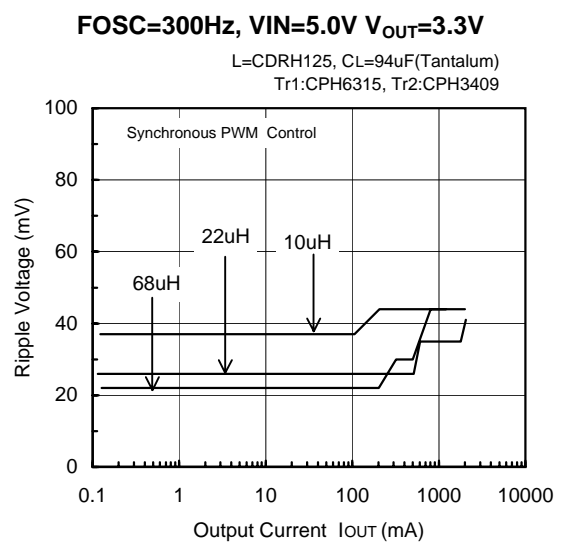
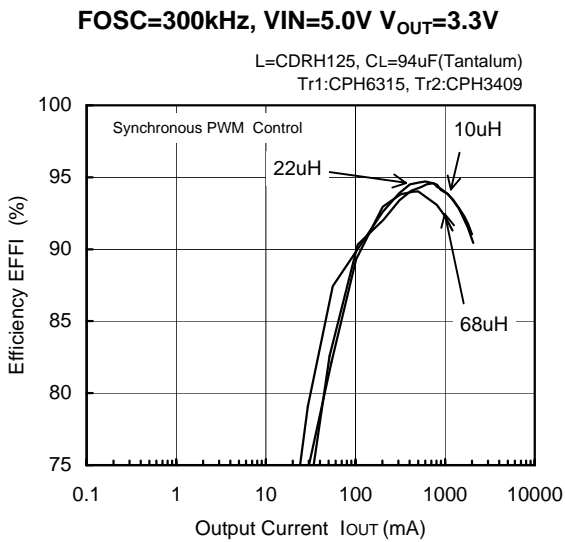

(5) Supply Current 1 vs. Supply Voltage

**XC9210B093(300kHz)**

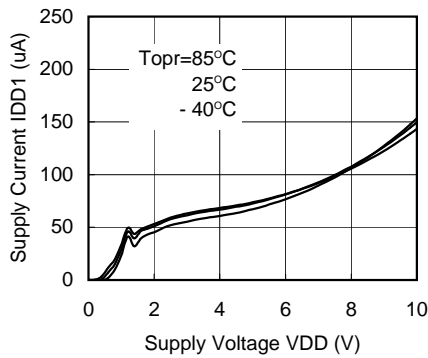

(6) Supply Current 2 vs. Supply Voltage

**XC9210B093(300kHz)**

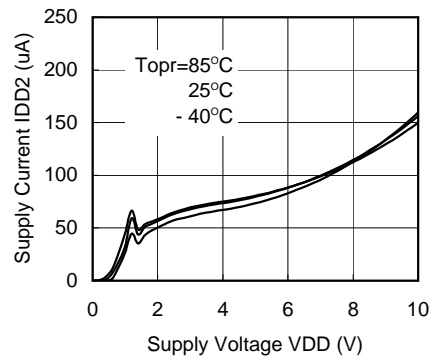

(7) Standby Current vs Supply Voltage

**XC9210B093(300kHz)**

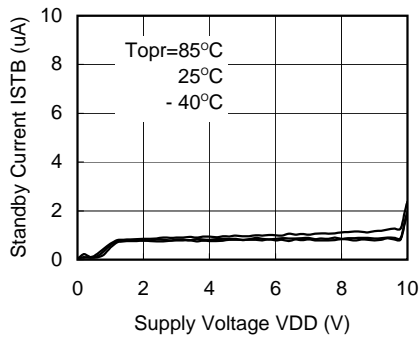

(8) Softstart Time vs. Supply Voltage

**XC9210B093 (300kHz)**

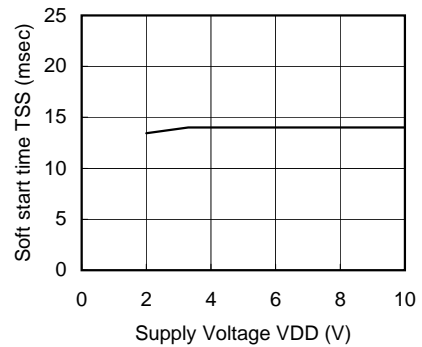

(10) CE 'H' 'L' Voltage vs. Supply Voltage

**XC9210B093 (300kHz)**

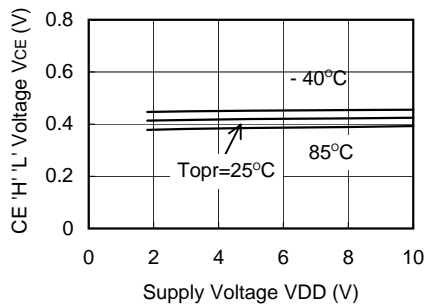

(11) PWM 'H' 'L' Voltage vs. Supply Voltage

**XC9210B093 (300kHz)**

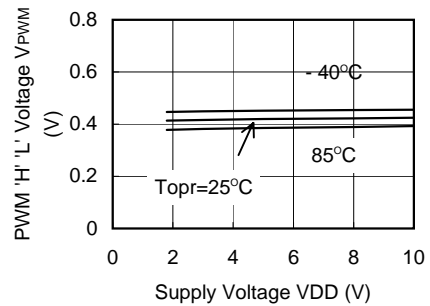

(12) MODE 'H' 'L' Voltage vs. Supply Voltage

**XC9210B093 (300kHz)**

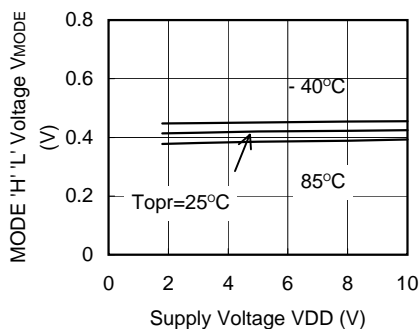

(13) Oscillation Frequency vs. Supply Voltage

**XC9210B093(300kHz)**

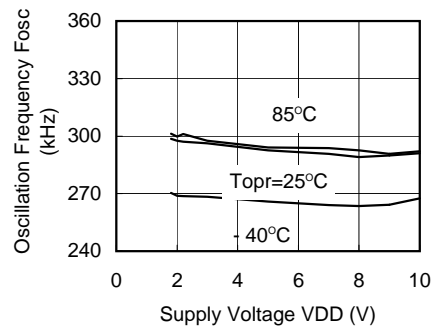



(14) EXT 1 H ON Resistance vs. Supply Voltage

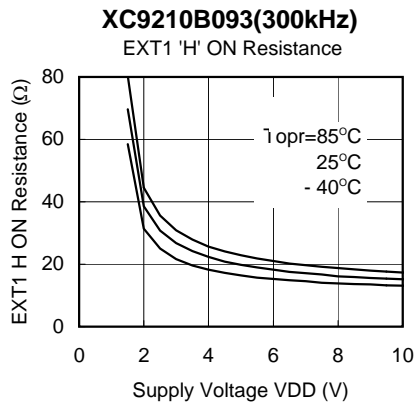

(15) EXT L ON Resistance vs. Supply Voltage

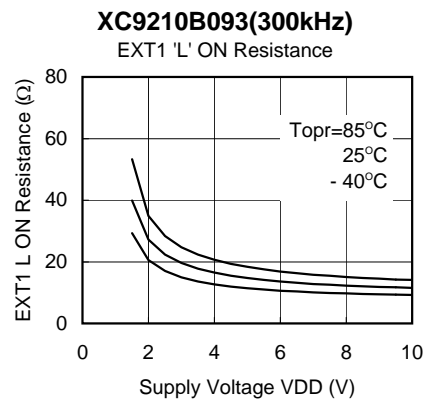

(16) EXT2 H ON Resistance vs. Supply Voltage

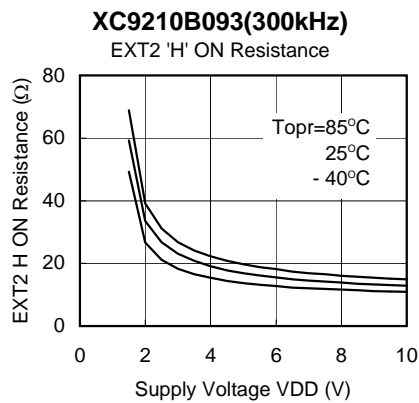

(17) EXT2 L ON Resistance vs. Supply Voltage

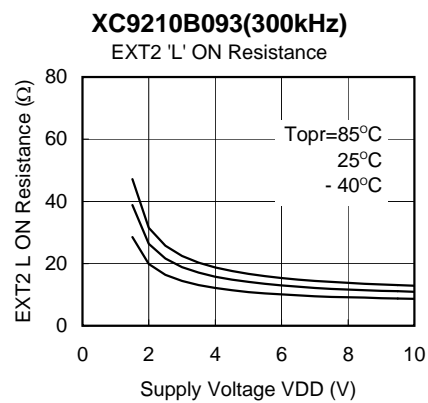

(18) Output Voltage vs. Ambient Temperature 1

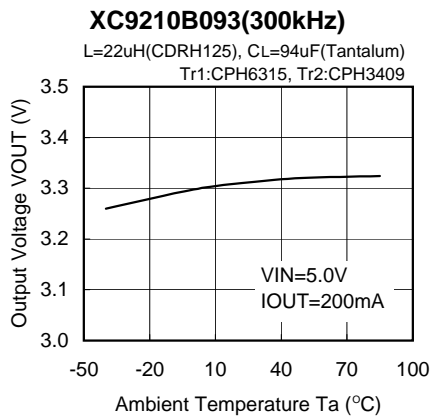

(19) Output Voltage vs. Ambient Temperature 2

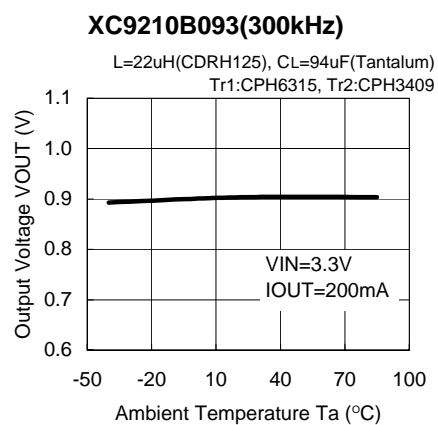

(20) PFM Duty Ratio vs. Supply Voltage

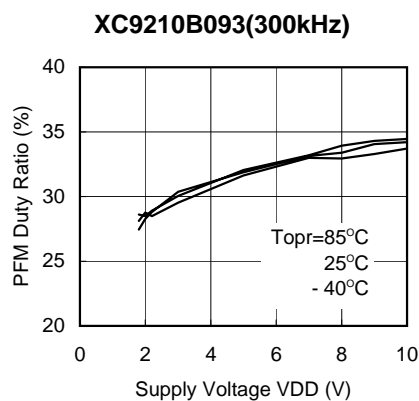

### ■ LOAD TRANSIENT RESPONSE

< VOUT = 3.3 V, VIN = 5.0V IOUT = 100 $\mu$ A  $\leftrightarrow$  300mA >

#### ○ Synchronous PWM Control

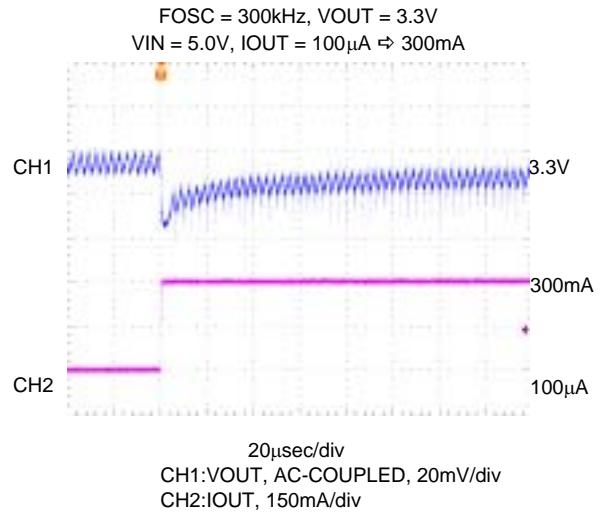
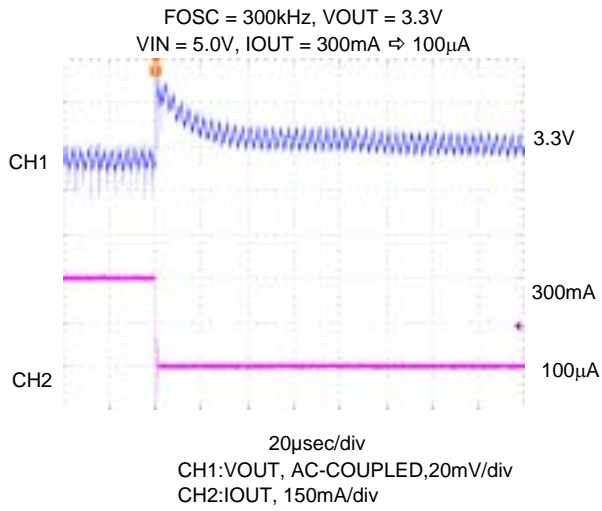

#### ○ PWM Control

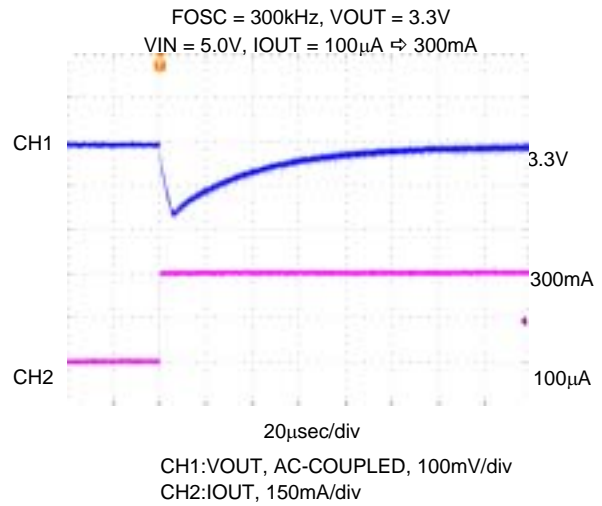
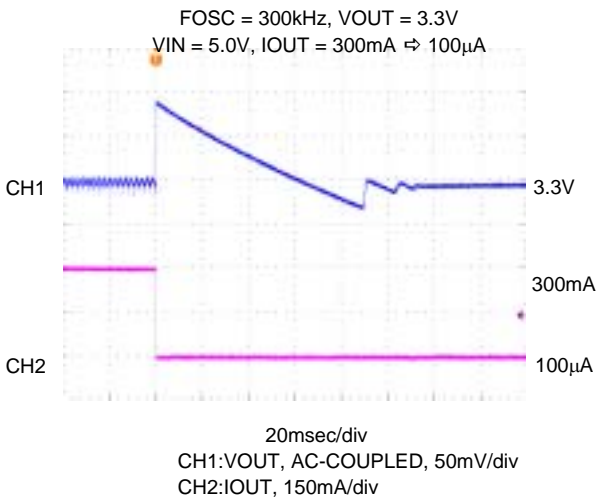

#### ○ PWM/PFM Switching Control

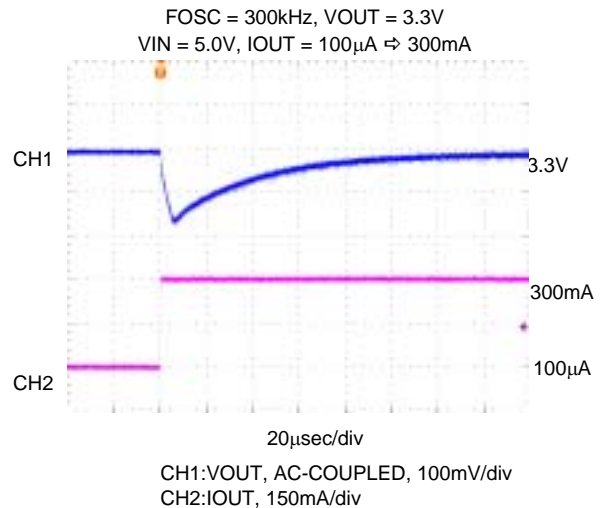
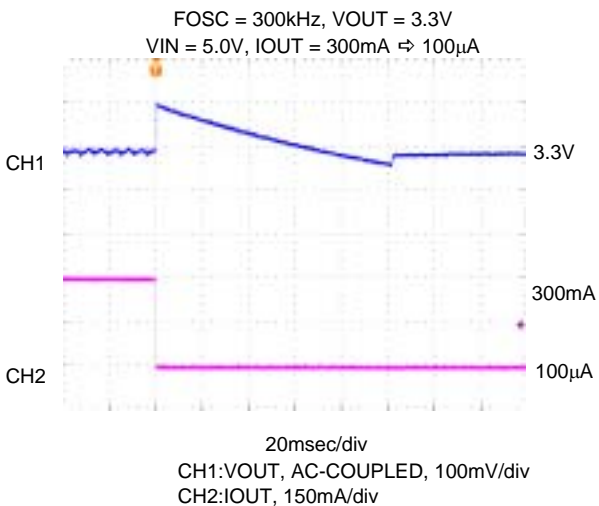

< VOUT = 3.3 V, VIN = 5.0V IOUT = 10mA ⇔ 300mA >

○ Synchronous PWM Control

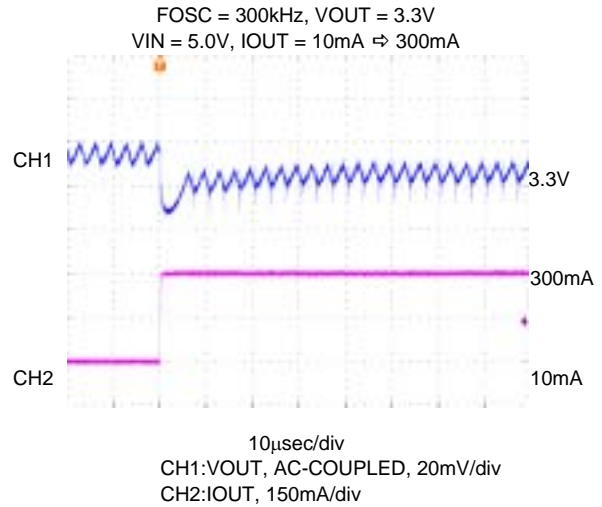
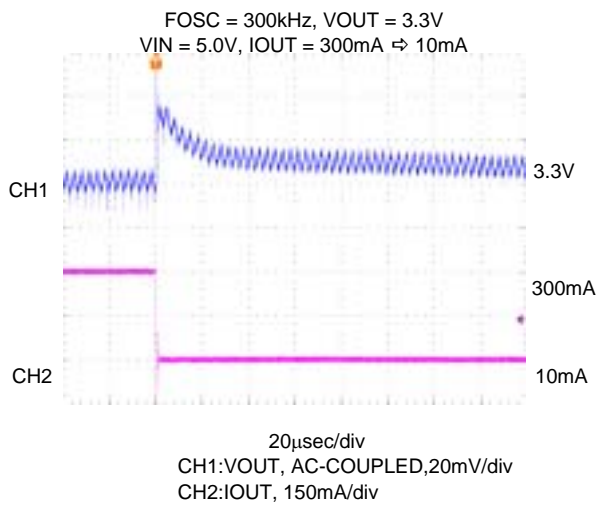

○ PWM Control

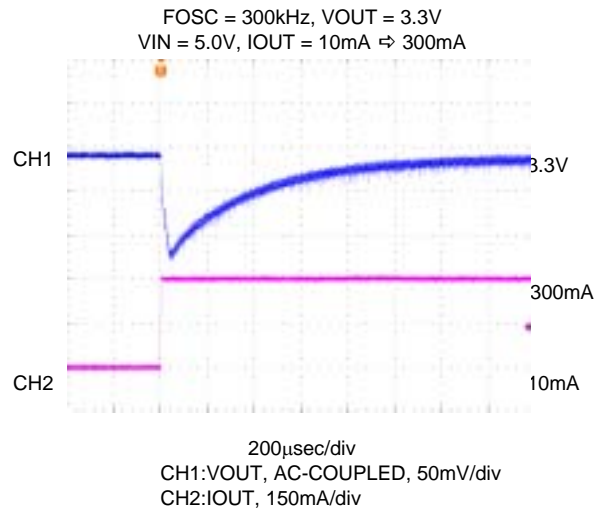
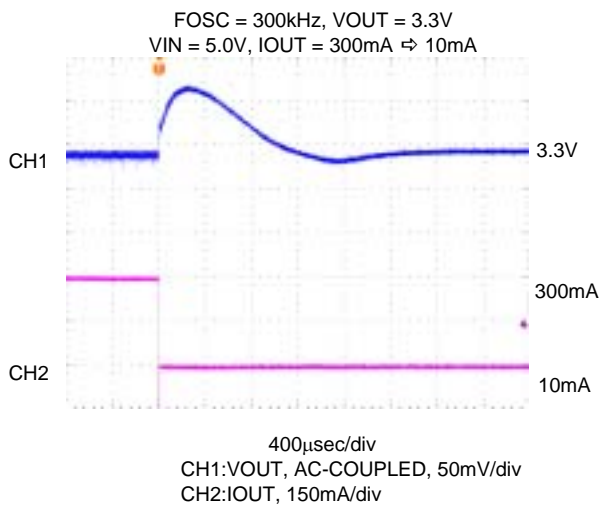

○ PWM/PFM Switching Control

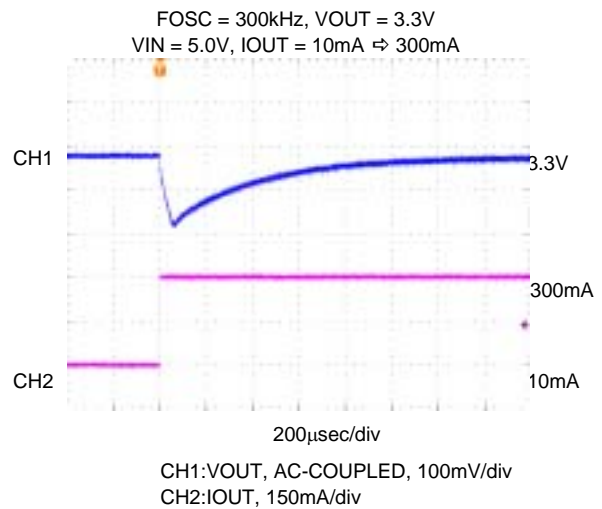
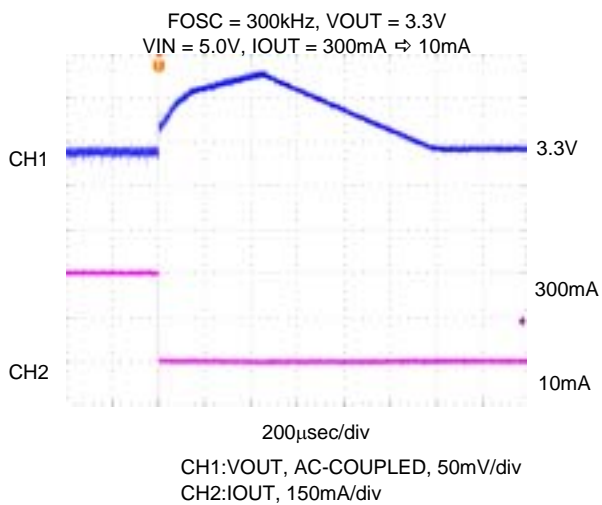

< VOUT = 3.3 V, VIN = 5.0V      IOU<sub>T</sub> = 100μA ⇔ 1000mA >

○ Synchronous PWM Control

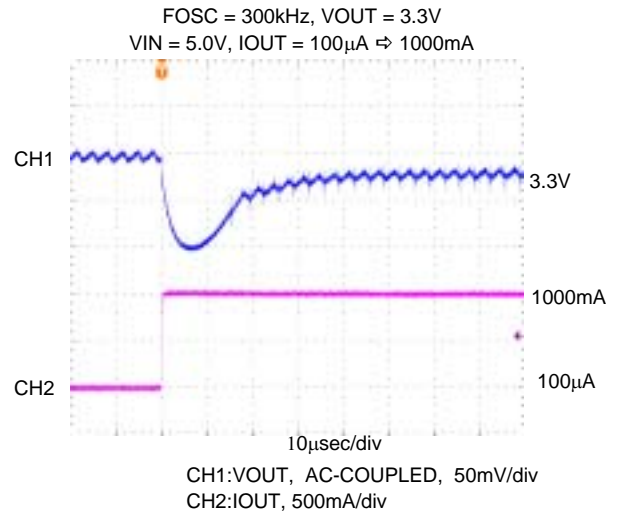
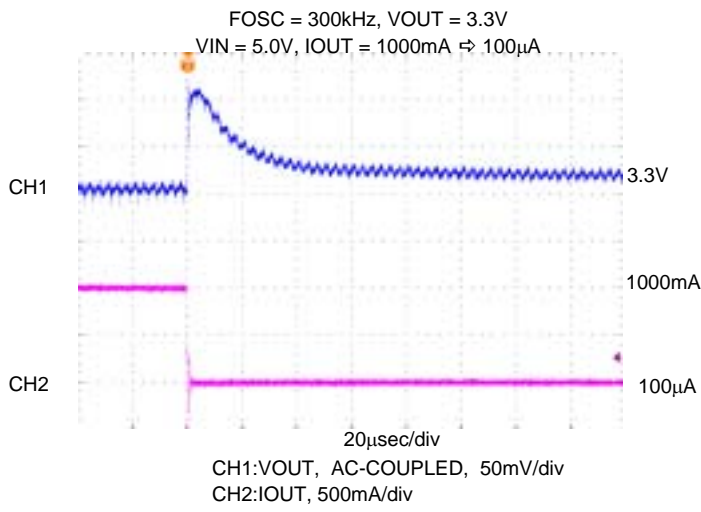

< VOUT = 3.3 V, VIN = 5.0V      IOU<sub>T</sub> = 10mA ⇔ 1000mA >

○ Synchronous PWM Control

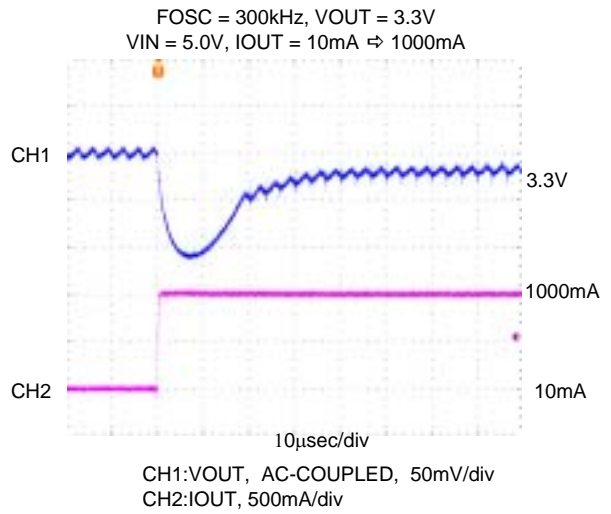
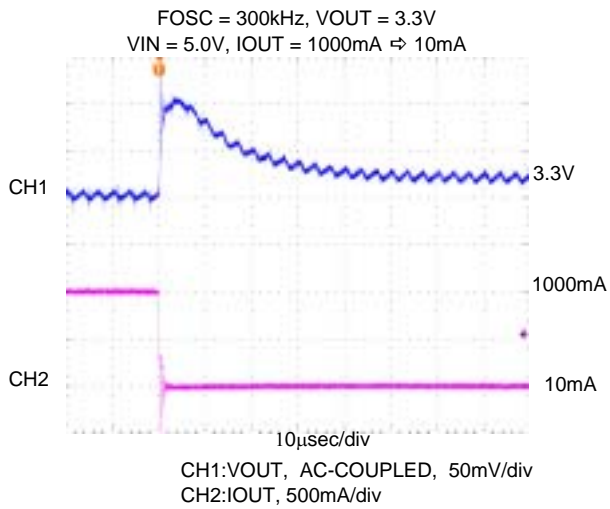

< VOUT = 0.9 V, VIN = 3.3V IOUT = 100 $\mu$ A  $\leftrightarrow$  300mA >

○ Synchronous PWM Control

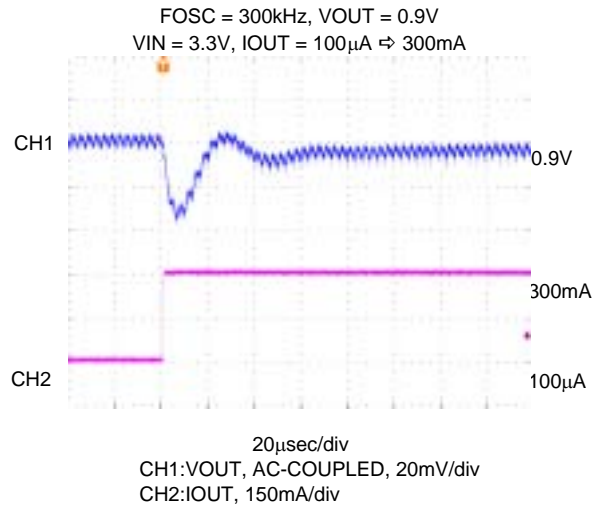
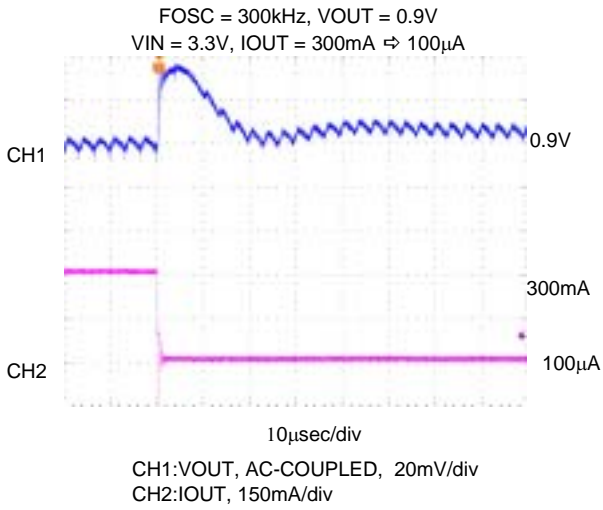

○ PWM Control

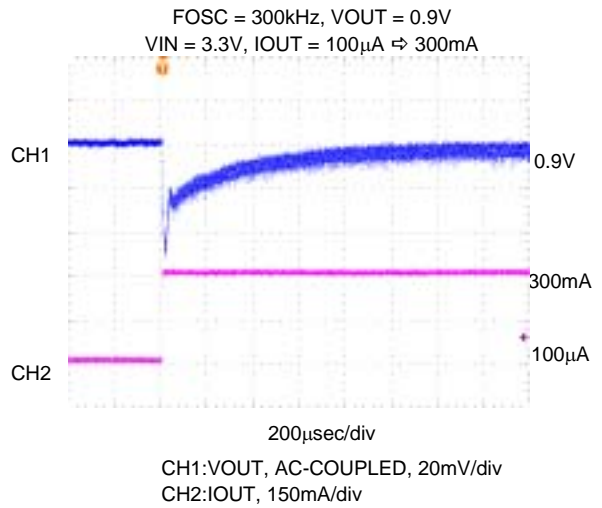
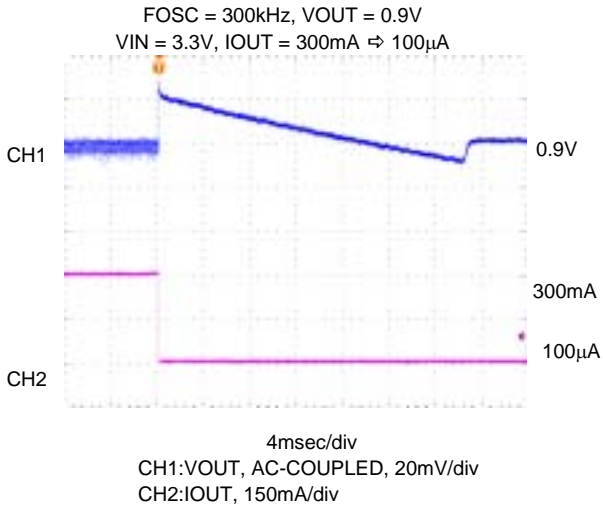

○ PWM/PFM Switching Control

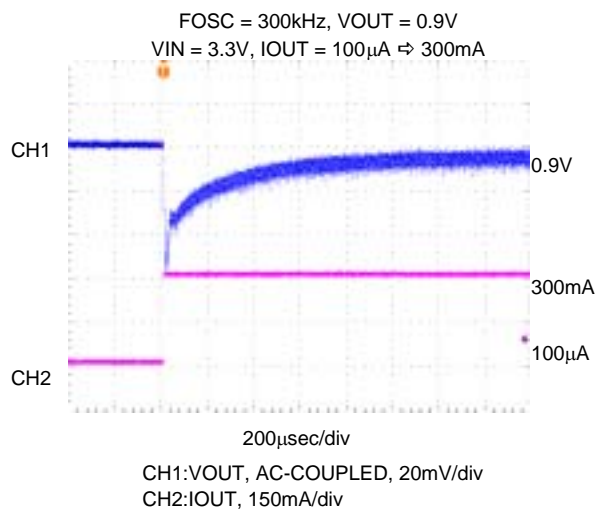
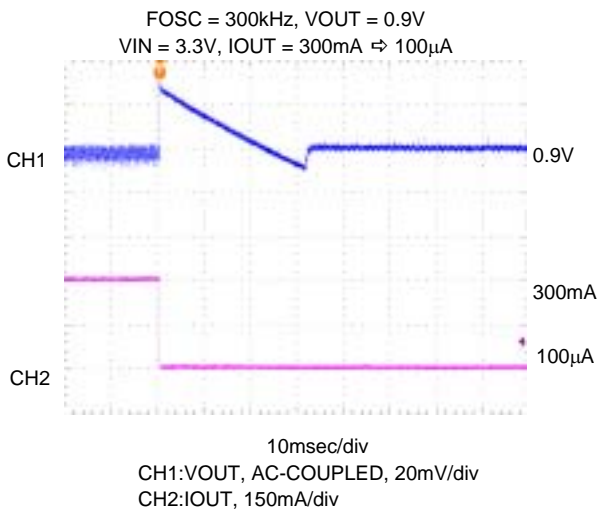

< VOUT = 0.9 V, VIN = 3.3V IOUT = 10mA ⇔ 300mA >

○ Synchronous PWM Control

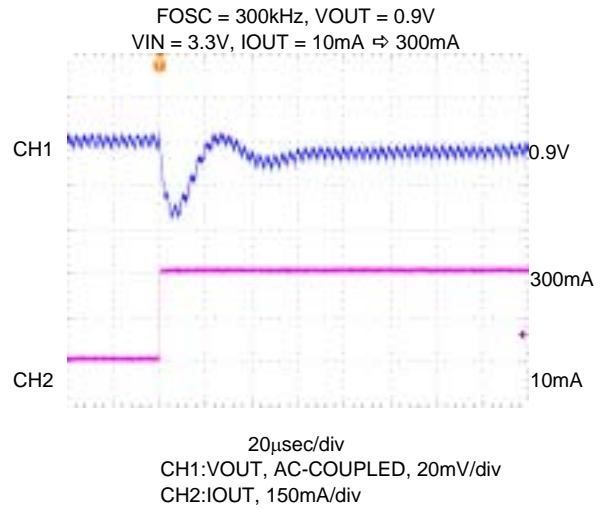
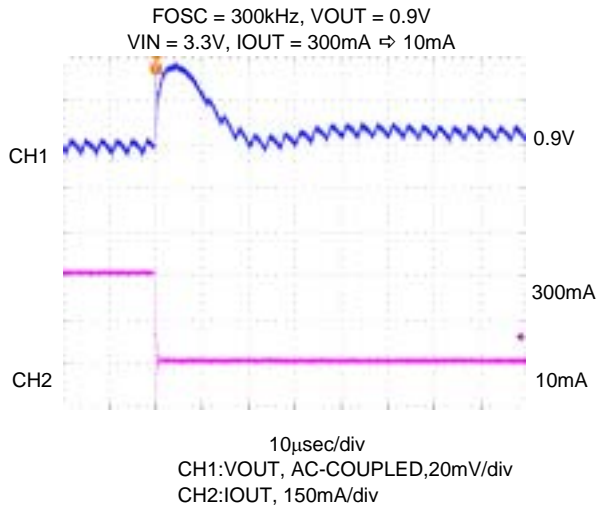

○ PWM Control

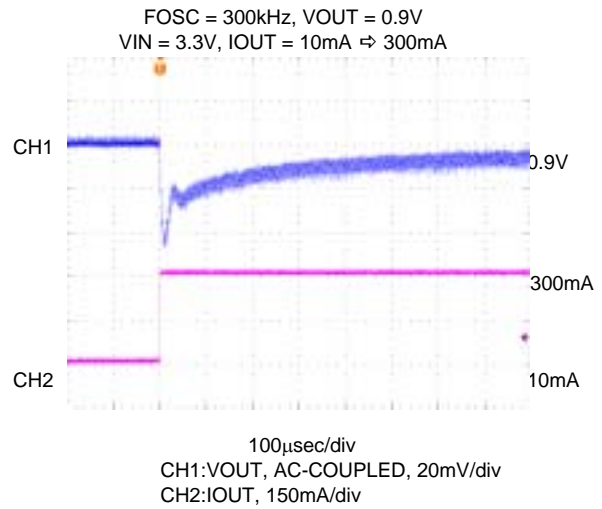
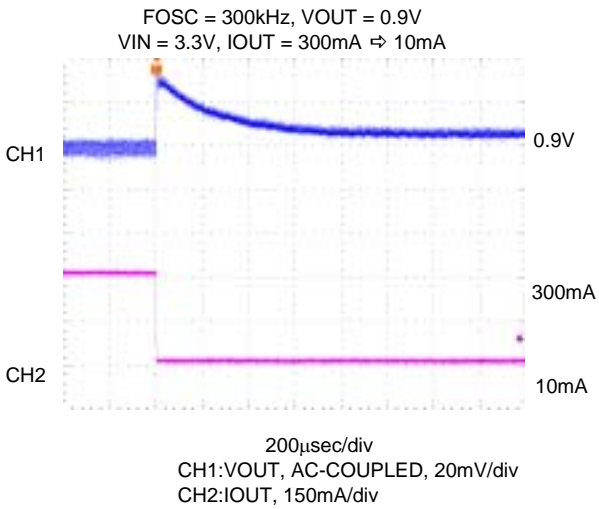

○ PWM/PFM Switching Control

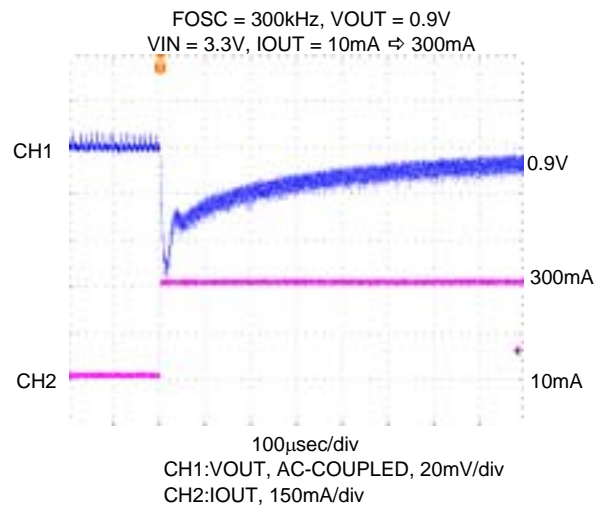
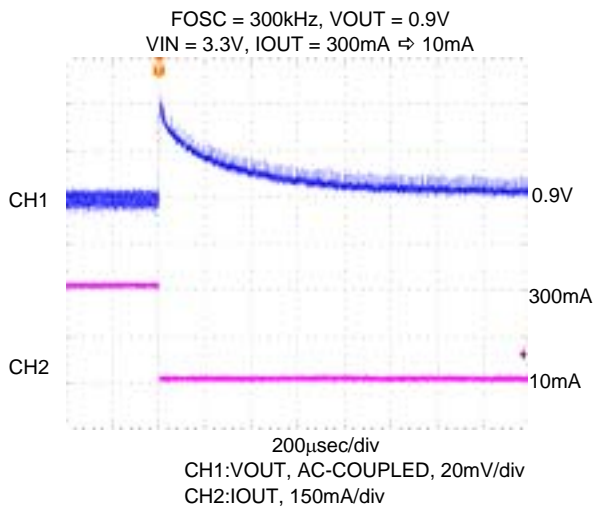

< VOUT = 0.9 V, VIN = 3.3V IOUT = 100 $\mu$ A  $\leftrightarrow$  1000mA >

○ Synchronous PWM Control

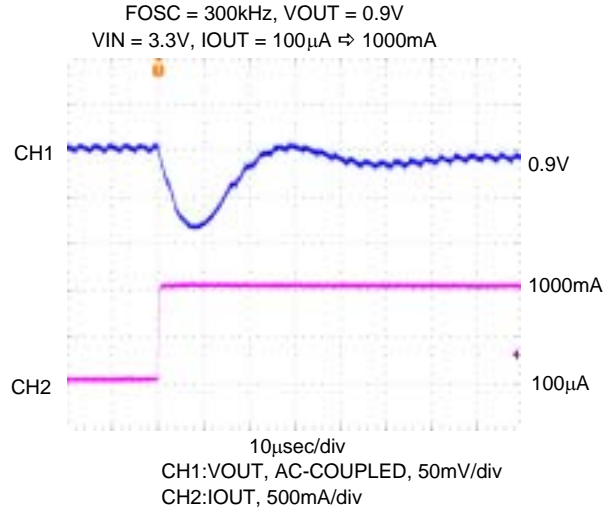
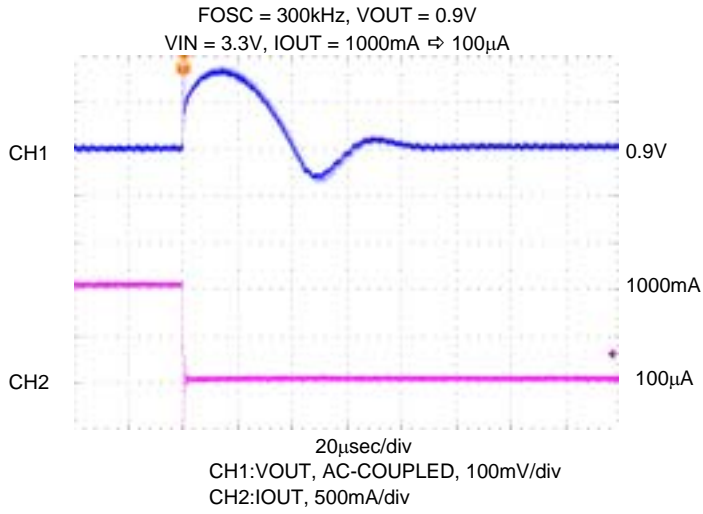

< VOUT = 0.9 V, VIN = 3.3V IOUT = 10mA  $\leftrightarrow$  1000mA >

○ Synchronous PWM Control

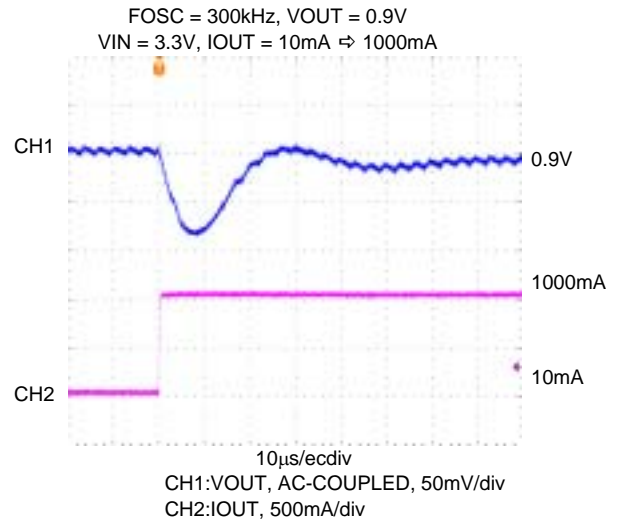
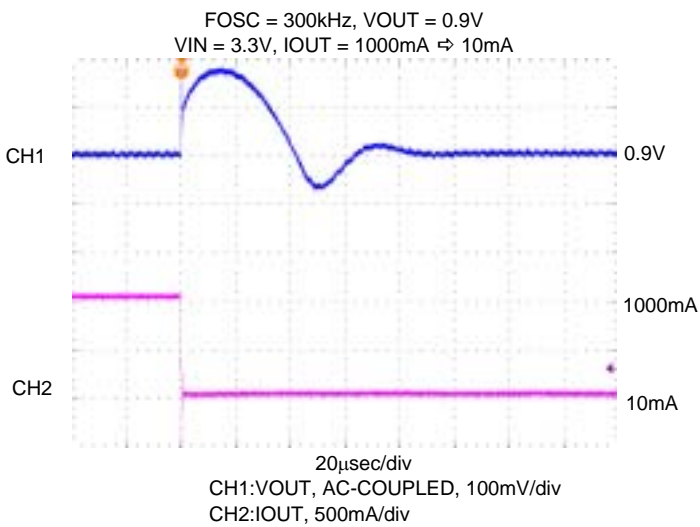

### < PWM Control ↔ Synchronous PWM Control >

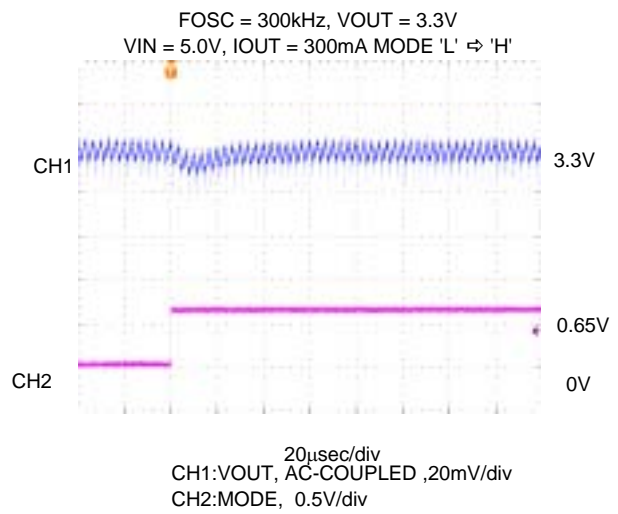
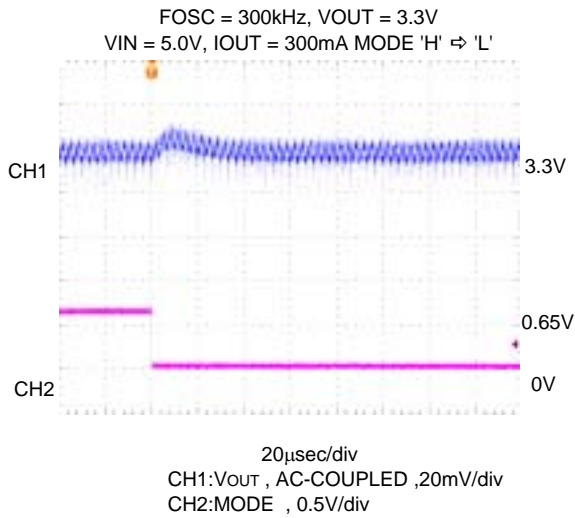

### < PWM Control ↔ PWM / PFM Switching Control >

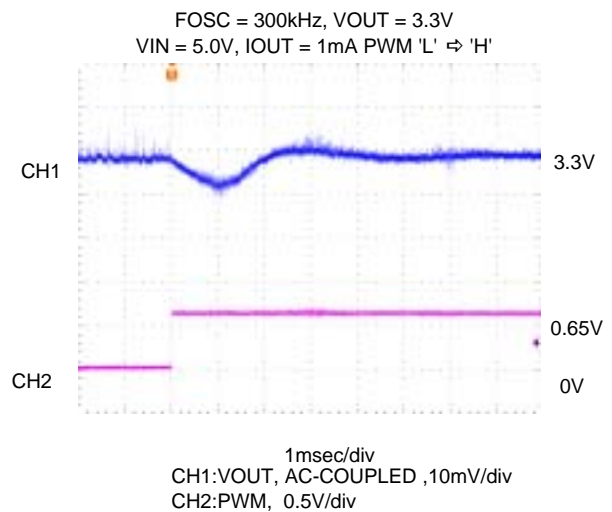
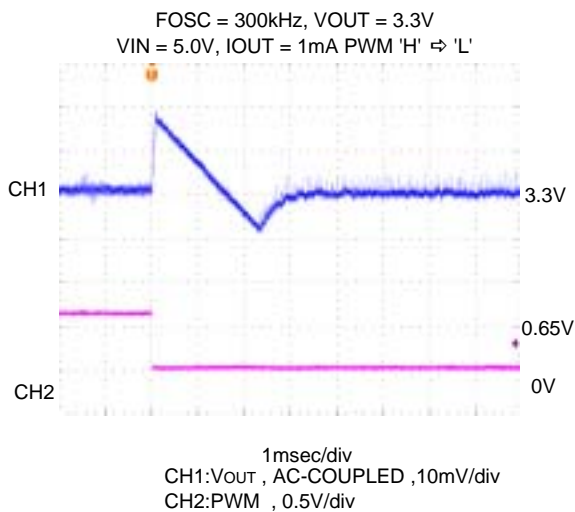

### < Softstart Wave Form >

