

N-Channel Dual Gate MOS-Fieldeffect Tetrode, Depletion Mode

Electrostatic sensitive device.
Observe precautions for handling.



Applications

Input- and mixer stages in UHF tuners.

Features

- Integrated gate protection diodes
- Low noise figure
- Low feedback capacitance
- High cross modulation performance
- Low input capacitance
- High AGC-range

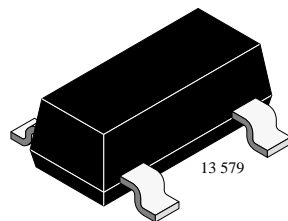
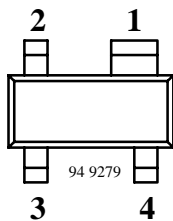

BF996S Marking: MH
Plastic case (SOT 143)
1=Source, 2=Drain, 3=Gate 2, 4=Gate 1

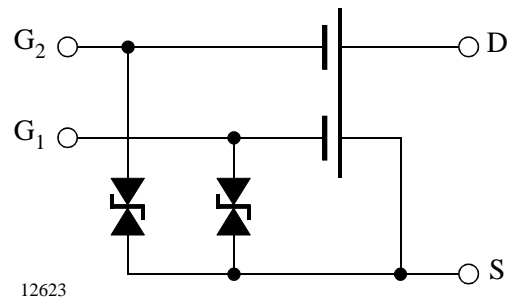

Absolute Maximum Ratings

$T_{amb} = 25^{\circ}\text{C}$, unless otherwise specified

Parameter	Test Conditions	Type	Symbol	Value	Unit
Drain - source voltage			V_{DS}	20	V
Drain current			I_D	30	mA
Gate 1/Gate 2 - source peak current			$\pm I_{G1/G2SM}$	10	mA
Total power dissipation	$T_{amb} \leq 60^{\circ}\text{C}$		P_{tot}	200	mW
Channel temperature			T_{Ch}	150	$^{\circ}\text{C}$
Storage temperature range			T_{stg}	-65 to +150	$^{\circ}\text{C}$

Maximum Thermal Resistance

$T_{amb} = 25^{\circ}\text{C}$, unless otherwise specified

Parameter	Test Conditions	Symbol	Value	Unit
Channel ambient	on glass fibre printed board (25 x 20 x 1.5) mm ³ plated with 35 μm Cu	R_{thChA}	450	K/W

Electrical DC Characteristics

$T_{amb} = 25^{\circ}\text{C}$, unless otherwise specified

Parameter	Test Conditions	Type	Symbol	Min	Typ	Max	Unit
Drain - source breakdown voltage	$I_D = 10 \mu\text{A}$, $-V_{G1S} = -V_{G2S} = 4 \text{ V}$		$V_{(BR)DS}$	20			V
Gate 1 - source breakdown voltage	$\pm I_{G1S} = 10 \text{ mA}$, $V_{G2S} = V_{DS} = 0$		$\pm V_{(BR)G1SS}$	8		14	V
Gate 2 - source breakdown voltage	$\pm I_{G2S} = 10 \text{ mA}$, $V_{G1S} = V_{DS} = 0$		$\pm V_{(BR)G2SS}$	8		14	V
Gate 1 - source leakage current	$\pm V_{G1S} = 5 \text{ V}$, $V_{G2S} = V_{DS} = 0$		$\pm I_{G1SS}$			50	nA
Gate 2 - source leakage current	$\pm V_{G2S} = 5 \text{ V}$, $V_{G1S} = V_{DS} = 0$		$\pm I_{G2SS}$			50	nA
Drain current	$V_{DS} = 15 \text{ V}$, $V_{G1S} = 0$, $V_{G2S} = 4 \text{ V}$	BF996S	I_{DSS}	4		18	mA
		BF996SA	I_{DSS}	4		10.5	mA
		BF996SB	I_{DSS}	9.5		18	mA
Gate 1 - source cut-off voltage	$V_{DS} = 15 \text{ V}$, $V_{G2S} = 4 \text{ V}$, $I_D = 20 \mu\text{A}$		$-V_{G1S(OFF)}$			2.5	V
Gate 2 - source cut-off voltage	$V_{DS} = 15 \text{ V}$, $V_{G1S} = 0$, $I_D = 20 \mu\text{A}$		$-V_{G2S(OFF)}$			2.0	V

Electrical AC Characteristics

$V_{DS} = 15 \text{ V}$, $I_D = 10 \text{ mA}$, $V_{G2S} = 4 \text{ V}$, $f = 1 \text{ MHz}$, $T_{amb} = 25^{\circ}\text{C}$, unless otherwise specified

Parameter	Test Conditions	Symbol	Min	Typ	Max	Unit
Forward transadmittance		$ y_{21s} $	15	18.5		mS
Gate 1 input capacitance		C_{issg1}		2.2	2.6	pF
Gate 2 input capacitance	$V_{G1S} = 0$, $V_{G2S} = 4 \text{ V}$	C_{issg2}		1.1		pF
Feedback capacitance		C_{rss}		25	35	fF
Output capacitance		C_{oss}		10.8	1.2	pF
Power gain	$G_S = 2 \text{ mS}$, $G_L = 0.5 \text{ mS}$, $f = 200 \text{ MHz}$	G_{ps}		25		dB
	$G_S = 3.3 \text{ mS}$, $G_L = 1 \text{ mS}$, $f = 800 \text{ MHz}$	G_{ps}		18		dB
AGC range	$V_{G2S} = 4 \text{ to } -2 \text{ V}$, $f = 800 \text{ MHz}$	ΔG_{ps}	40			dB
Noise figure	$G_S = 2 \text{ mS}$, $G_L = 0.5 \text{ mS}$, $f = 200 \text{ MHz}$	F		1.0		dB
	$G_S = 3.3 \text{ mS}$, $G_L = 1 \text{ mS}$, $f = 800 \text{ MHz}$	F		1.8		dB



Common Source S-Parameters

$V_{DS} = 15\text{ V}$, $V_{G2S} = 4\text{ V}$, $Z_0 = 50\ \Omega$, $T_{amb} = 25^\circ\text{C}$, unless otherwise specified

I_D/mA	f/MHz	S11		S21		S12		S22	
		LOG MAG	ANG	LOG MAG	ANG	LOG MAG	ANG	LOG MAG	ANG
		dB	deg	dB	deg	dB	deg	dB	deg
5	100	-0.05	-8.5	3.24	164.9	-56.84	82.2	-0.08	-3.4
	200	-0.15	-17.7	3.63	150.9	-50.57	75.6	-0.18	-7.1
	300	-0.43	-24.6	2.51	134.7	-48.51	67.7	-0.29	-9.7
	400	-0.70	-32.1	2.01	121.3	-46.98	62.8	-0.44	-12.3
	500	-1.03	-39.2	1.45	108.4	-46.40	57.8	-0.59	-15.1
	600	-1.33	-45.8	0.94	96.5	-46.40	57.3	-0.76	-17.4
	700	-1.62	-52.3	0.43	85.0	-47.02	58.9	-0.91	-19.7
	800	-1.92	-58.7	-0.10	74.1	-47.53	63.3	-1.08	-22.0
	900	-2.21	-64.7	-0.59	63.6	-47.81	73.1	-1.26	-24.3
	1000	-2.49	-70.7	-1.12	53.1	-48.52	83.5	-1.45	-26.2
	1100	-2.80	-76.6	-1.52	43.7	-48.53	102.1	-1.57	-28.4
	1200	-3.07	-82.5	-1.93	33.6	-46.95	120.4	-1.75	-30.5
	1300	-3.31	-88.6	-2.35	24.1	-44.44	131.7	-1.92	-32.7
10	100	-0.05	-9.0	5.19	165.3	-56.24	81.9	-0.11	-3.5
	200	-0.16	-18.7	5.58	151.8	-49.97	75.0	-0.21	-7.2
	300	-0.48	-26.0	4.45	136.3	-47.91	67.2	-0.33	-9.8
	400	-0.76	-33.7	3.95	123.3	-46.48	61.8	-0.47	-12.6
	500	-1.11	-41.2	3.40	110.9	-45.91	56.3	-0.65	-15.3
	600	-1.43	-48.3	2.88	99.5	-45.91	55.8	-0.81	-17.8
	700	-1.75	-55.1	2.39	88.7	-46.53	56.7	-0.96	-20.0
	800	-2.07	-61.6	1.88	78.1	-47.13	60.7	-1.12	-22.4
	900	-2.40	-67.9	1.39	67.9	-47.41	69.9	-1.32	-24.6
	1000	-2.70	-74.2	0.90	57.9	-48.21	80.0	-1.49	-26.6
	1100	-3.03	-80.2	0.50	48.7	-48.43	98.9	-1.61	-28.8
	1200	-3.32	-86.4	0.13	38.9	-47.04	118.2	-1.79	-31.0
	1300	-3.59	-92.3	-0.28	29.6	-44.54	130.5	-1.96	-33.3
15	100	-0.05	-9.4	6.07	165.4	-55.74	81.4	-0.15	-3.6
	200	-0.17	-19.4	6.44	152.0	-49.47	74.6	-0.24	-7.3
	300	-0.50	-27.1	5.31	136.7	-47.41	66.4	-0.36	-10.0
	400	-0.81	-35.0	4.80	123.8	-45.98	60.8	-0.52	-12.9
	500	-1.18	-42.9	4.23	111.5	-45.41	55.1	-0.68	-15.7
	600	-1.52	-50.3	3.72	100.3	-45.41	54.4	-0.84	-18.0
	700	-1.86	-57.2	3.22	89.6	-46.13	54.9	-1.02	-20.4
	800	-2.20	-63.9	2.72	79.4	-46.63	58.5	-1.16	-22.7
	900	-2.53	-70.4	2.24	69.2	-47.00	67.3	-1.35	-25.0
	1000	-2.86	-76.8	1.74	59.4	-47.91	76.7	-1.53	-27.1
	1100	-3.21	-82.9	1.34	50.2	-48.33	95.2	-1.66	-29.4
	1200	-3.50	-89.0	0.95	40.8	-47.04	115.3	-1.84	-31.6
	1300	-3.80	-95.1	0.56	31.5	-44.53	128.7	-2.00	-33.9

Typical Characteristics ($T_{amb} = 25^{\circ}\text{C}$ unless otherwise specified)

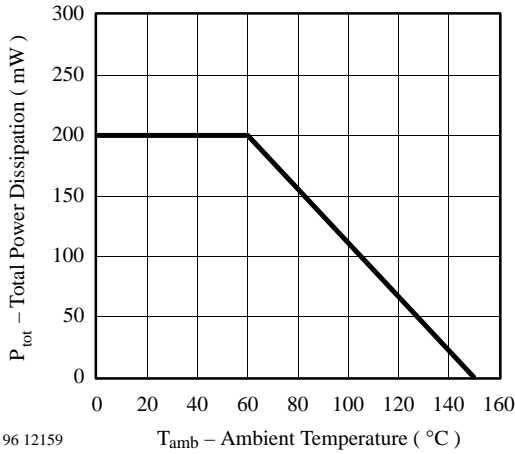

Figure 1. Total Power Dissipation vs. Ambient Temperature

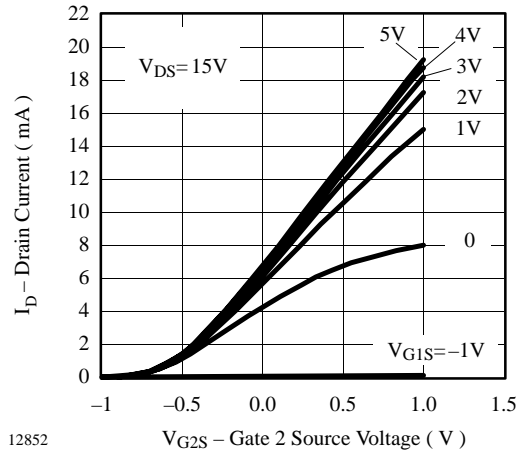

Figure 4. Drain Current vs. Gate 2 Source Voltage

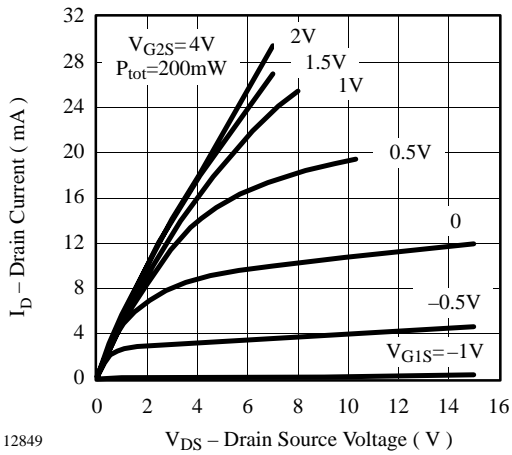

Figure 2. Drain Current vs. Drain Source Voltage

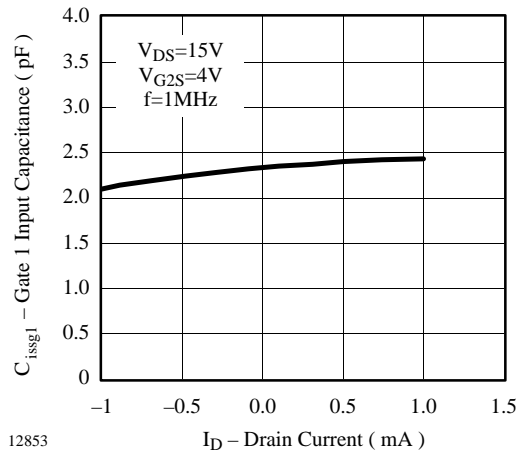

Figure 5. Gate 1 Input Capacitance vs. Drain Current

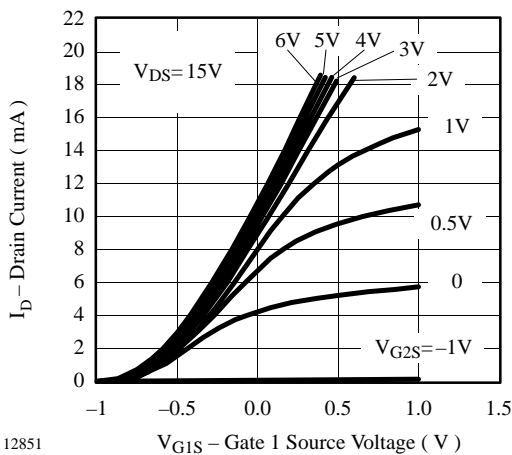

Figure 3. Drain Current vs. Gate 1 Source Voltage

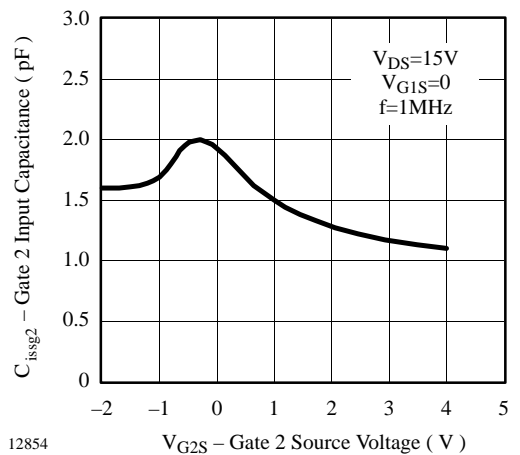
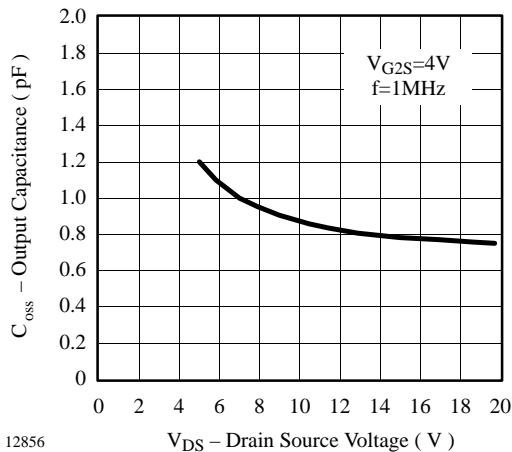
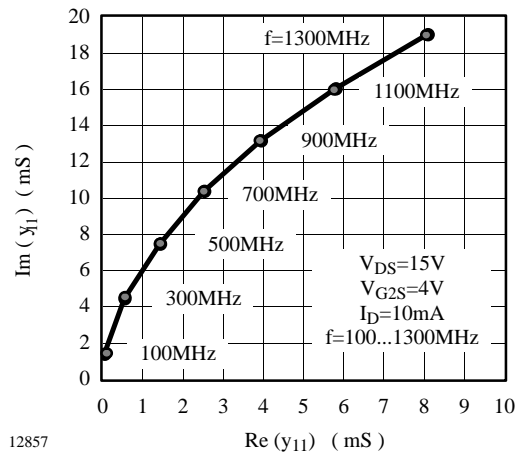

Figure 6. Gate 2 Input Capacitance vs. Gate 2 Source Voltage



12856 **Figure 7. Output Capacitance vs. Drain Source Voltage**



12857 **Figure 10. Short Circuit Input Admittance**

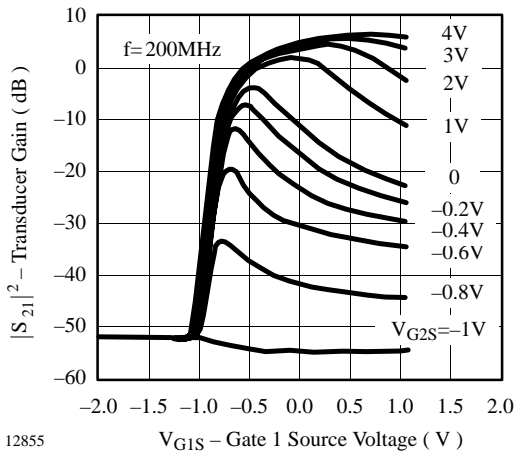

12855 **Figure 8. Transducer Gain vs. Gate 1 Source Voltage**

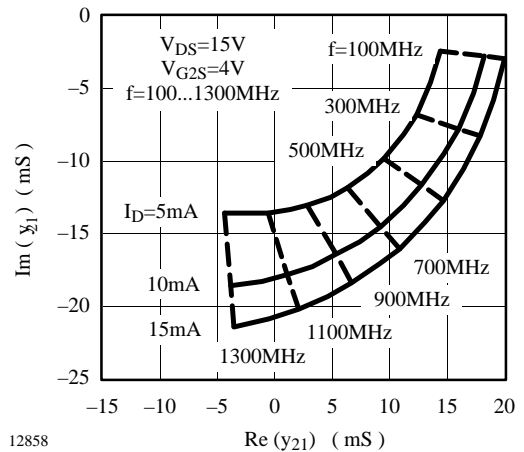

12858 **Figure 11. Short Circuit Forward Transfer Admittance**

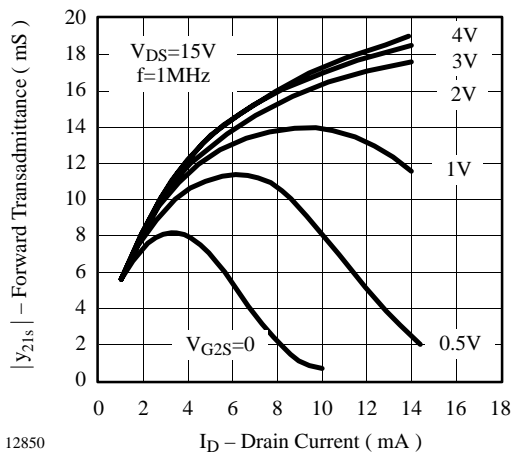

12850 **Figure 9. Forward Transadmittance vs. Drain Current**

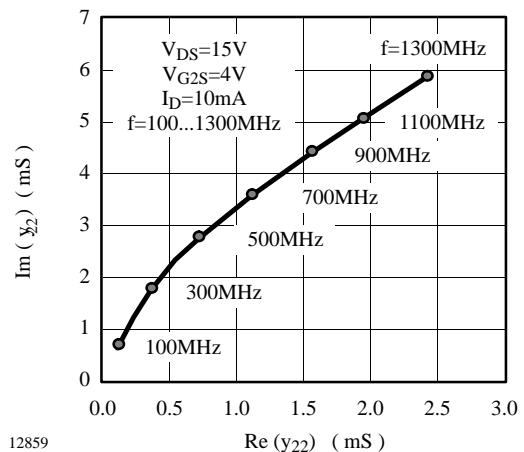

12859 **Figure 12. Short Circuit Output Admittance**

$V_{DS} = 15 \text{ V}$, $I_D = 10 \text{ mA}$, $V_{G2S} = 4 \text{ V}$, $Z_0 = 50 \Omega$

S_{11}

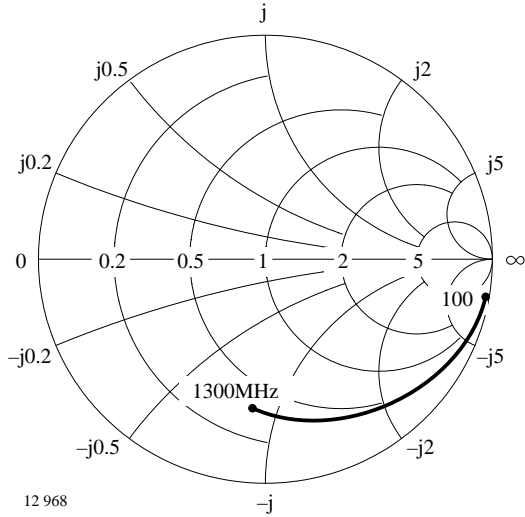

Figure 13. Input reflection coefficient

S_{12}

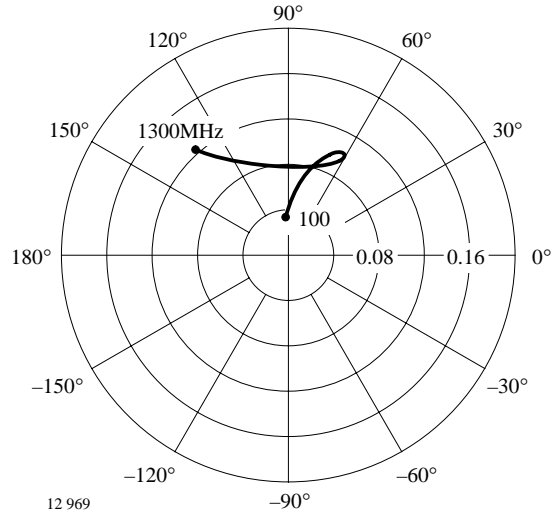

Figure 15. Reverse transmission coefficient

S_{21}

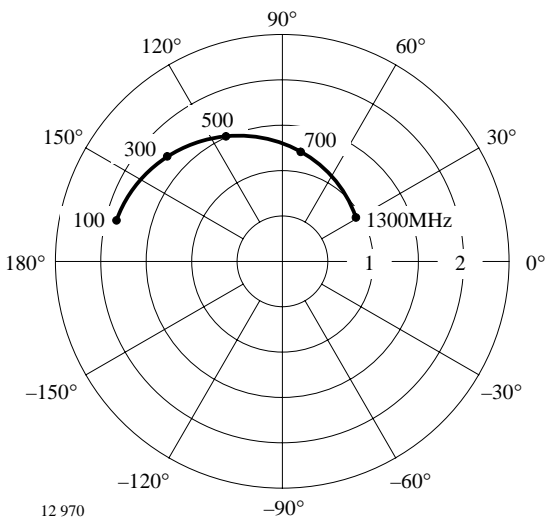

Figure 14. Forward transmission coefficient

S_{22}

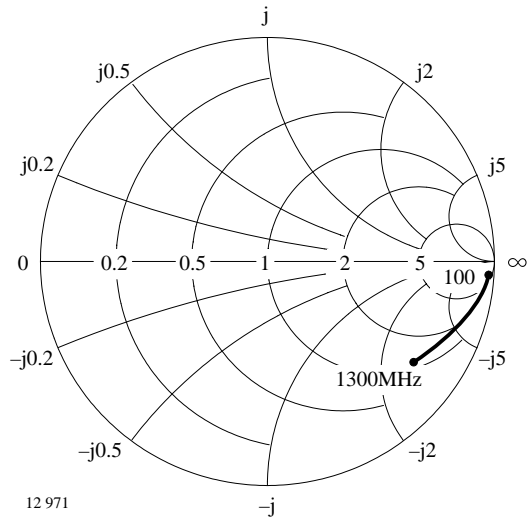
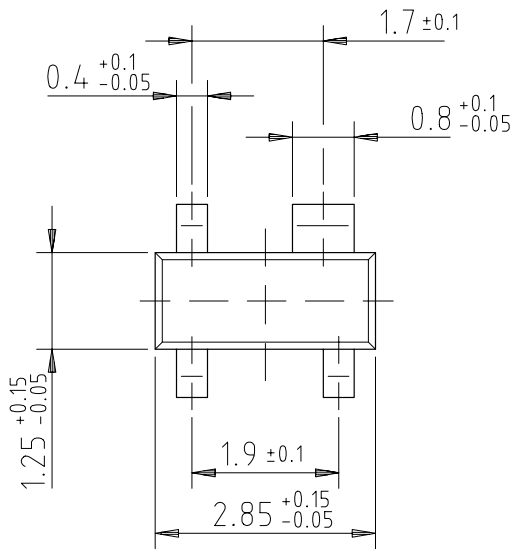
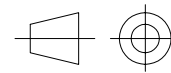

Figure 16. Output reflection coefficient

Dimensions in mm



96 12240



technical drawings
 according to DIN
 specifications

Ozone Depleting Substances Policy Statement

It is the policy of **Vishay Semiconductor GmbH** to

1. Meet all present and future national and international statutory requirements.
2. Regularly and continuously improve the performance of our products, processes, distribution and operating systems with respect to their impact on the health and safety of our employees and the public, as well as their impact on the environment.

It is particular concern to control or eliminate releases of those substances into the atmosphere which are known as ozone depleting substances (ODSs).

The Montreal Protocol (1987) and its London Amendments (1990) intend to severely restrict the use of ODSs and forbid their use within the next ten years. Various national and international initiatives are pressing for an earlier ban on these substances.

Vishay Semiconductor GmbH has been able to use its policy of continuous improvements to eliminate the use of ODSs listed in the following documents.

1. Annex A, B and list of transitional substances of the Montreal Protocol and the London Amendments respectively
2. Class I and II ozone depleting substances in the Clean Air Act Amendments of 1990 by the Environmental Protection Agency (EPA) in the USA
3. Council Decision 88/540/EEC and 91/690/EEC Annex A, B and C (transitional substances) respectively.

Vishay Semiconductor GmbH can certify that our semiconductors are not manufactured with ozone depleting substances and do not contain such substances.

We reserve the right to make changes to improve technical design and may do so without further notice.

Parameters can vary in different applications. All operating parameters must be validated for each customer application by the customer. Should the buyer use Vishay-Telefunken products for any unintended or unauthorized application, the buyer shall indemnify Vishay-Telefunken against all claims, costs, damages, and expenses, arising out of, directly or indirectly, any claim of personal damage, injury or death associated with such unintended or unauthorized use.

Vishay Semiconductor GmbH, P.O.B. 3535, D-74025 Heilbronn, Germany
Telephone: 49 (0)7131 67 2831, Fax number: 49 (0)7131 67 2423