

# NID6002N

Preferred Device

## Self-Protected FET with Temperature and Current Limit

65 V, 6.5 A, Single N-Channel, DPAK

HDPlus™ devices are an advanced series of power MOSFETs which utilize ON Semiconductor's latest MOSFET technology process to achieve the lowest possible on-resistance per silicon area while incorporating smart features. Integrated thermal and current limits work together to provide short circuit protection. The devices feature an integrated Drain-to-Gate Clamp that enables them to withstand high energy in the avalanche mode. The Clamp also provides additional safety margin against unexpected voltage transients. Electrostatic Discharge (ESD) protection is provided by an integrated Gate-to-Source Clamp.

### Features

- Short Circuit Protection/Current Limit
- Thermal Shutdown with Automatic Restart
- $I_{DSS}$  Specified at Elevated Temperature
- Avalanche Energy Specified
- Slew Rate Control for Low Noise Switching
- Overvoltage Clamped Protection
- Pb-Free Package is Available



ON Semiconductor®

<http://onsemi.com>

$V_{DSS}$ (Clamped)	$R_{DS(on)}$ TYP	$I_D$ TYP (Limited)
65 V	210 mΩ	6.5 A

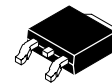
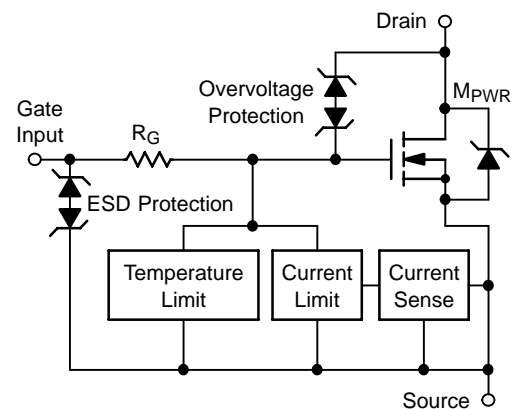

DPAK  
CASE 369C  
STYLE 2

### MARKING DIAGRAM

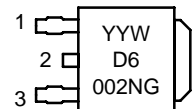

D6002N = Device Code  
Y = Year  
WW = Work Week  
G = Pb-Free Device

1 = Gate  
2 = Drain  
3 = Source

### ORDERING INFORMATION

Device	Package	Shipping†
NID6002NT4	DPAK	2500/Tape & Reel
NID6002NT4G	DPAK (Pb-Free)	2500/Tape & Reel

†For information on tape and reel specifications, including part orientation and tape sizes, please refer to our Tape and Reel Packaging Specification Brochure, BRD8011/D.

Preferred devices are recommended choices for future use and best overall value.

## NID6002N

### MOSFET MAXIMUM RATINGS (T<sub>J</sub> = 25°C unless otherwise noted)

Rating	Symbol	Value	Unit
Drain-to-Source Voltage Internally Clamped	V <sub>DSS</sub>	70	Vdc
Gate-to-Source Voltage	V <sub>GS</sub>	± 14	Vdc
Drain Current Continuous	I <sub>D</sub>	Internally Limited	
Total Power Dissipation @ T <sub>A</sub> = 25°C (Note 1) @ T <sub>A</sub> = 25°C (Note 2)	P <sub>D</sub>	1.3 2.5	W
Thermal Resistance Junction-to-Case Junction-to-Ambient (Note 1) Junction-to-Ambient (Note 2)	R <sub>θJC</sub> R <sub>θJA</sub> R <sub>θJA</sub>	3.0 95 50	°C/W
Single Pulse Drain-to-Source Avalanche Energy (V <sub>DD</sub> = 50 Vdc, V <sub>GS</sub> = 5.0 Vdc, I <sub>L</sub> = 1.3 Apk, L = 160 mH, R <sub>G</sub> = 25 Ω)	E <sub>AS</sub>	143	mJ
Operating and Storage Temperature Range (Note 3)	T <sub>J</sub> , T <sub>stg</sub>	-55 to 150	°C

Maximum ratings are those values beyond which device damage can occur. Maximum ratings applied to the device are individual stress limit values (not normal operating conditions) and are not valid simultaneously. If these limits are exceeded, device functional operation is not implied, damage may occur and reliability may be affected.

1. Surface mounted onto minimum pad size (100 sq/mm) FR4 PCB, 1 oz cu.
2. Mounted onto 1" square pad size (700 sq/mm) FR4 PCB, 1 oz cu.
3. Normal pre-fault operating range. See thermal limit range conditions.

# NID6002N

## MOSFET ELECTRICAL CHARACTERISTICS ( $T_J = 25^\circ\text{C}$ unless otherwise noted)

Characteristic	Symbol	Min	Typ	Max	Unit
----------------	--------	-----	-----	-----	------

### OFF CHARACTERISTICS

Drain-to-Source Clamped Breakdown Voltage ( $V_{GS} = 0\text{ V}$ , $I_D = 2\text{ mA}$ )	$V_{(BR)DSS}$	60	65	70	V
Zero Gate Voltage Drain Current ( $V_{DS} = 52\text{ V}$ , $V_{GS} = 0\text{ V}$ )	$I_{DSS}$	–	27	100	$\mu\text{A}$
Gate Input Current ( $V_{GS} = 5.0\text{ V}$ , $V_{DS} = 0\text{ V}$ )	$I_{GSS}$	–	45	200	$\mu\text{A}$

### ON CHARACTERISTICS

Gate Threshold Voltage ( $V_{DS} = V_{GS}$ , $I_D = 150\ \mu\text{A}$ ) Threshold Temperature Coefficient	$V_{GS(th)}$	1.0 –	1.85 5.0	2.4 –	V –mV/°C
Static Drain-to-Source On-Resistance (Note 4) ( $V_{GS} = 10\text{ V}$ , $I_D = 2.0\text{ A}$ , $T_J @ 25^\circ\text{C}$ )	$R_{DS(on)}$	–	185	210	m $\Omega$
Static Drain-to-Source On-Resistance (Note 4) ( $V_{GS} = 5.0\text{ V}$ , $I_D = 2.0\text{ A}$ , $T_J @ 25^\circ\text{C}$ ) ( $V_{GS} = 5.0\text{ V}$ , $I_D = 2.0\text{ A}$ , $T_J @ 150^\circ\text{C}$ )	$R_{DS(on)}$	– –	210 445	240 520	m $\Omega$
Source-Drain Forward On Voltage ( $I_S = 7.0\text{ A}$ , $V_{GS} = 0\text{ V}$ )	$V_{SD}$	–	0.9	1.1	V

### SWITCHING CHARACTERISTICS

Turn-on Delay Time	$R_L = 6.6\ \Omega$ , $V_{in} = 0\text{ to }10\text{ V}$ , $V_{DD} = 13.8\text{ V}$ , $I_D = 2.0\text{ A}$ , 10% $V_{in}$ to 10% $I_D$	$t_{d(on)}$	–	103	120	ns
Turn-on Rise Time	$R_L = 6.6\ \Omega$ , $V_{in} = 0\text{ to }10\text{ V}$ , $V_{DD} = 13.8\text{ V}$ , $I_D = 2.0\text{ A}$ , 10% $I_D$ to 90% $I_D$	$t_{rise}$	–	246	285	ns
Turn-off Delay Time	$R_L = 6.6\ \Omega$ , $V_{in} = 0\text{ to }10\text{ V}$ , $V_{DD} = 13.8\text{ V}$ , $I_D = 2.0\text{ A}$ , 90% $V_{in}$ to 90% $I_D$	$t_{d(off)}$	–	742	850	ns
Turn-off Fall Time	$R_L = 6.6\ \Omega$ , $V_{in} = 0\text{ to }10\text{ V}$ , $V_{DD} = 13.8\text{ V}$ , $I_D = 2.0\text{ A}$ , 90% $I_D$ to 10% $I_D$	$t_{fall}$	–	707	780	ns
Slew Rate ON	$R_L = 6.6\ \Omega$ , $V_{in} = 0\text{ to }10\text{ V}$ , $V_{DD} = 13.8\text{ V}$ , $I_D = 2.0\text{ A}$ , 70% to 50% $V_{DD}$	$dV_{DS}/dT_{on}$	–	73	–	V/ $\mu\text{s}$
Slew Rate OFF	$R_L = 6.6\ \Omega$ , $V_{in} = 0\text{ to }10\text{ V}$ , $V_{DD} = 13.8\text{ V}$ , $I_D = 2.0\text{ A}$ , 50% to 70% $V_{DD}$	$dV_{DS}/dT_{off}$	–	35	–	V/ $\mu\text{s}$

### SELF PROTECTION CHARACTERISTICS ( $T_J = 25^\circ\text{C}$ unless otherwise noted) (Note 5)

Current Limit	$V_{DS} = 10\text{ V}$ , $V_{GS} = 5.0\text{ V}$ , $T_J = 25^\circ\text{C}$ (Note 6) $V_{DS} = 10\text{ V}$ , $V_{GS} = 5.0\text{ V}$ , $T_J = 130^\circ\text{C}$ (Note 6) $V_{DS} = 10\text{ V}$ , $V_{GS} = 10\text{ V}$ , $T_J = 25^\circ\text{C}$ (Note 6)	$I_{LIM}$	4.0 4.0 –	6.4 5.5 7.9	11 11 –	A
Temperature Limit (Turn-off)	$V_{GS} = 5.0\text{ V}$	$T_{LIM(off)}$	150	180	200	°C
Thermal Hysteresis	$V_{GS} = 5.0\text{ V}$	$\Delta T_{LIM(on)}$	–	10	–	°C
Temperature Limit (Turn-off)	$V_{GS} = 10\text{ V}$	$T_{LIM(off)}$	150	180	200	°C
Thermal Hysteresis	$V_{GS} = 10\text{ V}$	$\Delta T_{LIM(on)}$	–	20	–	°C
Input Current during Thermal Fault	$V_{DS} = 0\text{ V}$ , $V_{GS} = 5.0\text{ V}$ , $T_J = T_J > T_{(fault)}$ $V_{DS} = 0\text{ V}$ , $V_{GS} = 10\text{ V}$ , $T_J = T_J > T_{(fault)}$	$I_{g(fault)}$	5.5 12	5.2 11	–	mA

### ESD ELECTRICAL CHARACTERISTICS ( $T_J = 25^\circ\text{C}$ unless otherwise noted)

Electro-Static Discharge Capability Human Body Model (HBM) Machine Model (MM)	ESD	8000 400	– –	– –	V
---	-----	-------------	--------	--------	---

4. Pulse Test: Pulse Width  $\leq 300\ \mu\text{s}$ , Duty Cycle  $\leq 2\%$ .
5. Fault conditions are viewed as beyond the normal operating range of the part.
6. Current limit measured at  $380\ \mu\text{s}$  after gate pulse.

TYPICAL PERFORMANCE CURVES

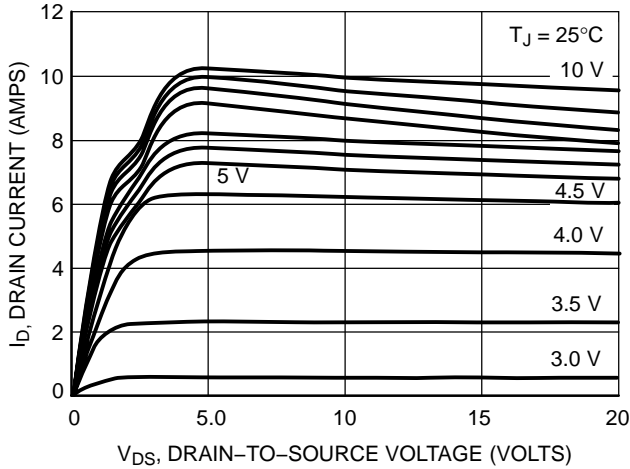

Figure 1. On-Region Characteristics

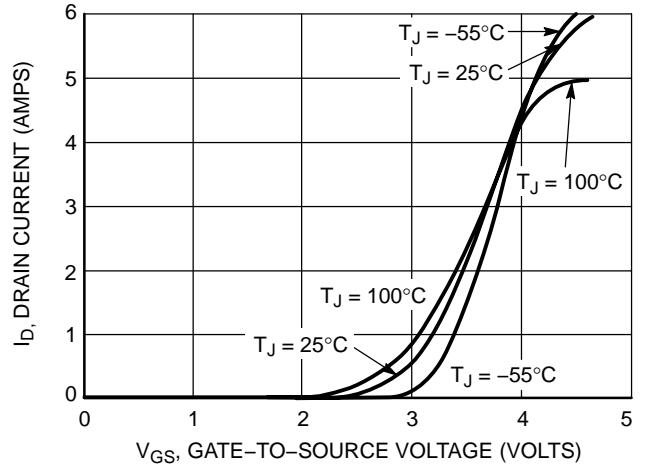

Figure 2. Transfer Characteristics

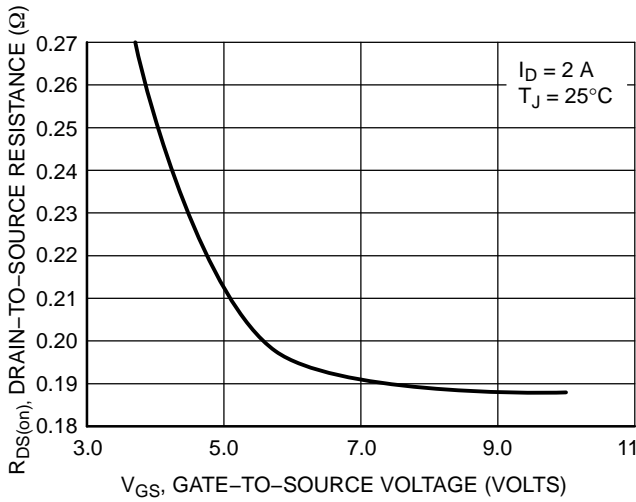

Figure 3. On-Resistance vs. Gate-to-Source Voltage

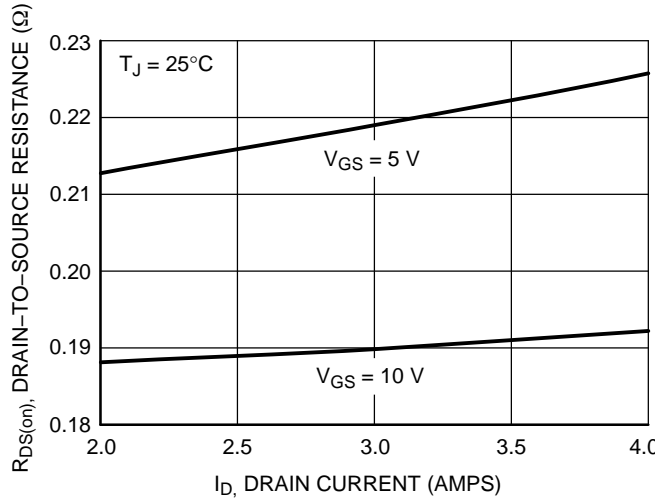

Figure 4. On-Resistance vs. Drain Current and Gate Voltage

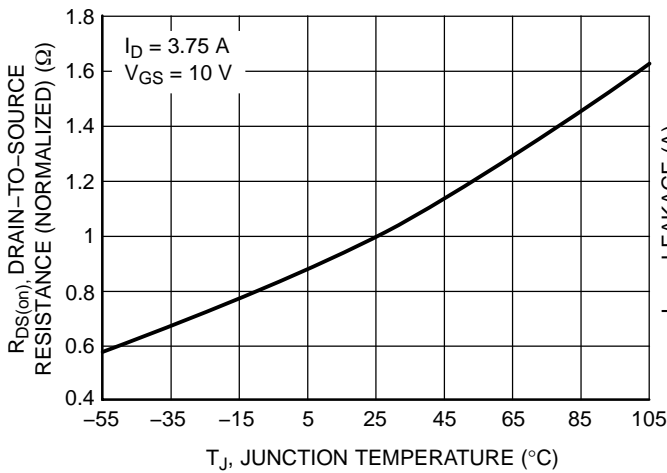

Figure 5. On-Resistance Variation with Temperature

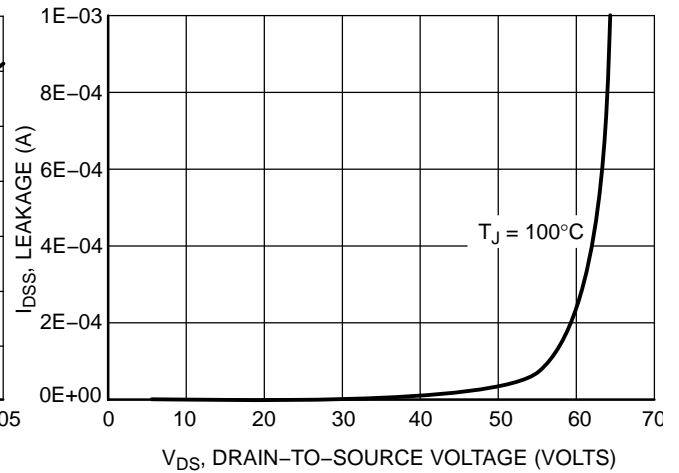

Figure 6. Drain-to-Source Leakage Current vs. Voltage

# NID6002N

## TYPICAL PERFORMANCE CURVES

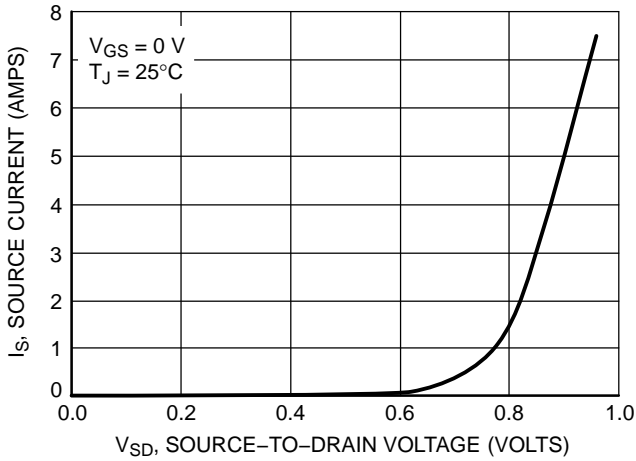

Figure 7. Diode Forward Voltage vs. Current

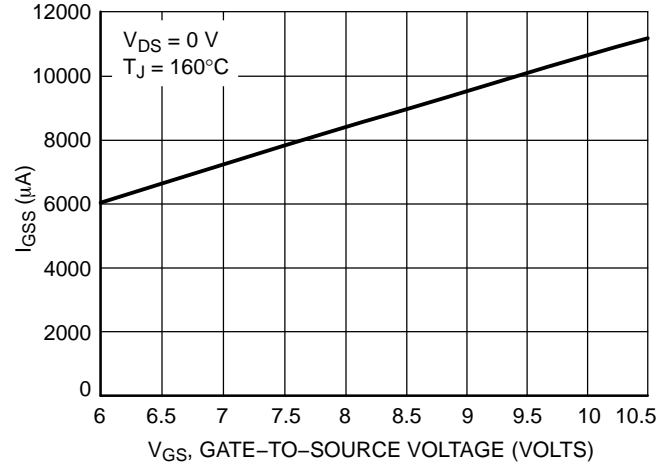

Figure 8. Input Current vs. Gate Voltage

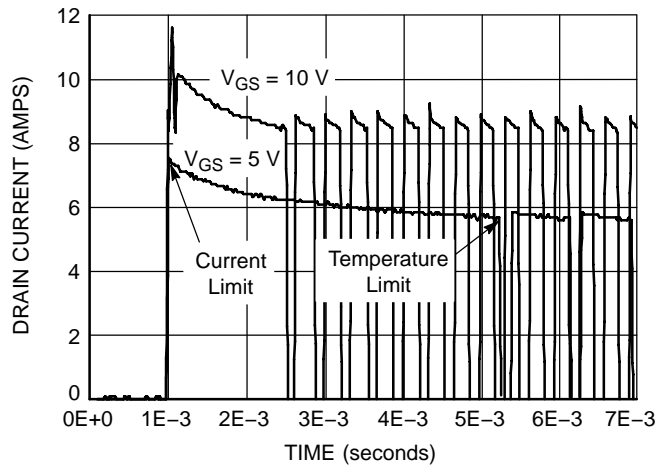

Figure 9. Short Circuit Response\*

\*(Actual thermal cycling response in short circuit dependent on device power level, thermal mounting, and ambient temperature conditions)

# NID6002N

## PACKAGE DIMENSIONS

DPAK  
CASE 369C-01  
ISSUE O

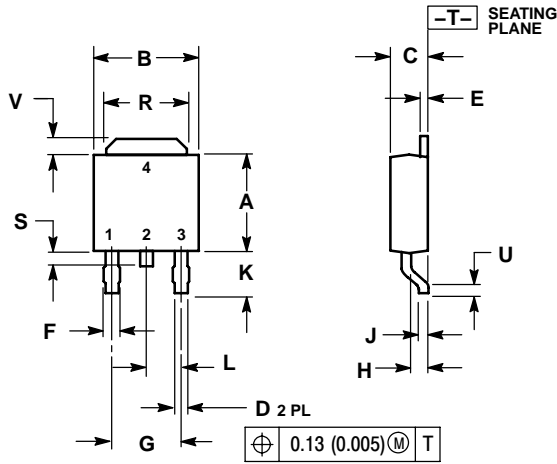

DIM	INCHES		MILLIMETERS	
	MIN	MAX	MIN	MAX
A	0.235	0.245	5.97	6.22
B	0.250	0.265	6.35	6.73
C	0.086	0.094	2.19	2.38
D	0.027	0.035	0.69	0.88
E	0.018	0.023	0.46	0.58
F	0.037	0.045	0.94	1.14
G	0.180 BSC		4.58 BSC	
H	0.034	0.040	0.87	1.01
J	0.018	0.023	0.46	0.58
K	0.102	0.114	2.60	2.89
L	0.090 BSC		2.29 BSC	
R	0.180	0.215	4.57	5.45
S	0.025	0.040	0.63	1.01
U	0.020	---	0.51	---
V	0.035	0.050	0.89	1.27
Z	0.155	---	3.93	---

STYLE 2:  
PIN 1. GATE  
2. DRAIN  
3. SOURCE  
4. DRAIN

## SOLDERING FOOTPRINT

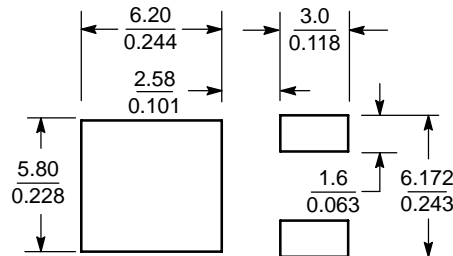

SCALE 3:1  $\left( \frac{\text{mm}}{\text{inches}} \right)$

HDPlus is a trademark of Semiconductor Components Industries, LLC (SCILLC)

ON Semiconductor and are registered trademarks of Semiconductor Components Industries, LLC (SCILLC). SCILLC reserves the right to make changes without further notice to any products herein. SCILLC makes no warranty, representation or guarantee regarding the suitability of its products for any particular purpose, nor does SCILLC assume any liability arising out of the application or use of any product or circuit, and specifically disclaims any and all liability, including without limitation special, consequential or incidental damages. "Typical" parameters which may be provided in SCILLC data sheets and/or specifications can and do vary in different applications and actual performance may vary over time. All operating parameters, including "Typicals" must be validated for each customer application by customer's technical experts. SCILLC does not convey any license under its patent rights nor the rights of others. SCILLC products are not designed, intended, or authorized for use as components in systems intended for surgical implant into the body, or other applications intended to support or sustain life, or for any other application in which the failure of the SCILLC product could create a situation where personal injury or death may occur. Should Buyer purchase or use SCILLC products for any such unintended or unauthorized application, Buyer shall indemnify and hold SCILLC and its officers, employees, subsidiaries, affiliates, and distributors harmless against all claims, costs, damages, and expenses, and reasonable attorney fees arising out of, directly or indirectly, any claim of personal injury or death associated with such unintended or unauthorized use, even if such claim alleges that SCILLC was negligent regarding the design or manufacture of the part. SCILLC is an Equal Opportunity/Affirmative Action Employer. This literature is subject to all applicable copyright laws and is not for resale in any manner.

## PUBLICATION ORDERING INFORMATION

**LITERATURE FULFILLMENT:**  
Literature Distribution Center for ON Semiconductor  
P.O. Box 61312, Phoenix, Arizona 85082-1312 USA  
**Phone:** 480-829-7710 or 800-344-3860 Toll Free USA/Canada  
**Fax:** 480-829-7709 or 800-344-3867 Toll Free USA/Canada  
**Email:** orderlit@onsemi.com

**N. American Technical Support:** 800-282-9855 Toll Free  
USA/Canada

**Japan:** ON Semiconductor, Japan Customer Focus Center  
2-9-1 Kamimeguro, Meguro-ku, Tokyo, Japan 153-0051  
**Phone:** 81-3-5773-3850

**ON Semiconductor Website:** <http://onsemi.com>

**Order Literature:** <http://www.onsemi.com/litorder>

For additional information, please contact your local Sales Representative.