

AN5790N, AN5792

Horizontal Signal Processing ICs for CRT Display

Overview

The AN5790N and AN5792 are the intergrated circuits designed for CRT display horizontal signal processing circuits.

Features

- Horizontal synchronous signal is available in both polarities.
- Wide range of horizontal oscillation frequency : 14kHz to 60kHz.
- Output pulse width : 2μs to 40μs
- Package
 - AN5790N...NF-12S(12-Pin SIL plastic package)
 - AN5792...F-12S (12-Pin SIL plastic package with fin)

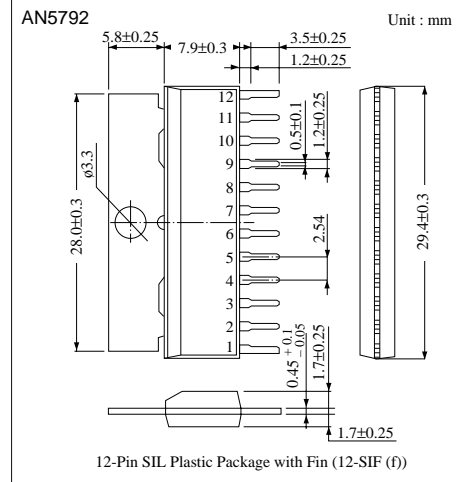
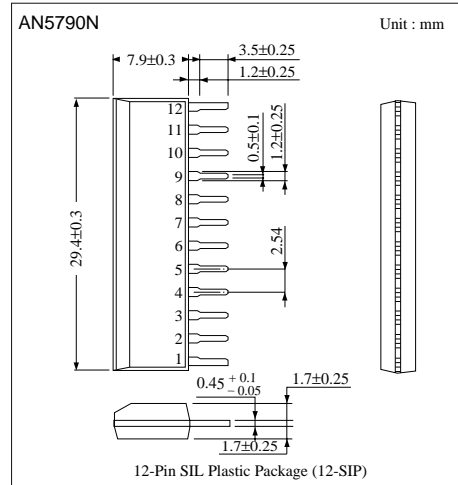

Block Diagram

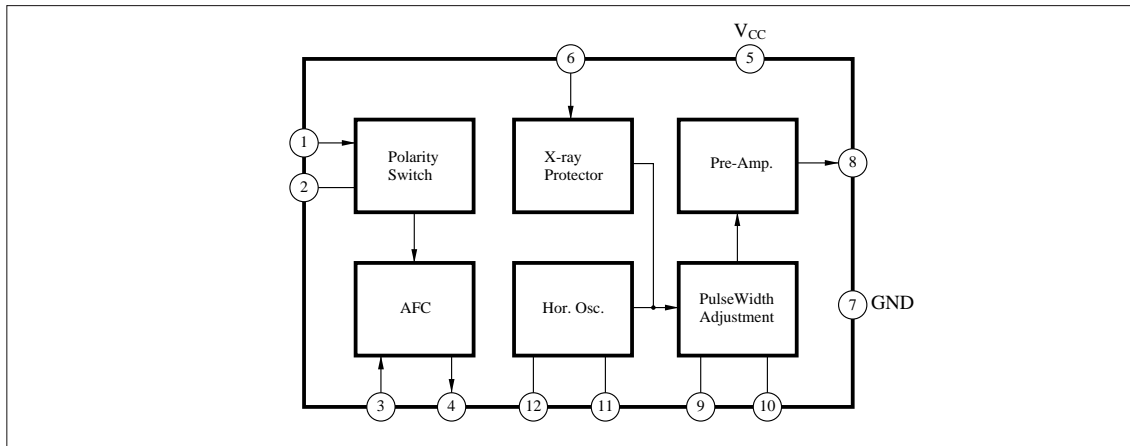

■ Absolute Maximum Ratings (Ta= 25°C)

Parameter		Symbol	Rating	Unit
Supply voltage		V _{CC}	13.2	V
Supply current		I _{CC}	50	mA
Power dissipation		P _D	1140	mW
Temperature	Operating ambient temperature	T _{opr}	- 20 to +70	°C
	Storage temperature	T _{stg}	- 40 to +150	°C



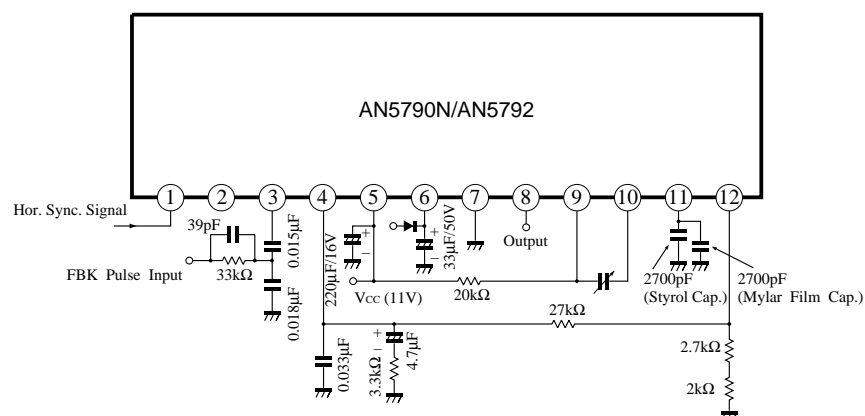

■ Electrical Characteristics (Ta= 25°C)

Parameter	Symbol	Condition	min	typ	max	Unit
Total circuit current	I _{tot}	V _{CC} =11V	30	45	60	mA
Polarity switching voltage (1)	V ₂₋₇	Positive polarity signal input	0	—	0.4	V
Polarity switching voltage (2)	V ₂₋₇	Negative polarity signal input	2.5	—	5.5	V
Horizontal oscillation start voltage	V _{OSC-S (H)}	f _{HO} =12kHz to 19kHz	7.5	—	—	V
Horizontal oscillation frequency	f _{HO (1)}	V _{CC} =11V, C= 4400pF	15	15.75	16.5	kHz
Horizontal oscillation frequency	f _{HO (2)}	V _{CC} =11V, C= 820pF, 5600pF	14	—	60	kHz
f _{HO} supply voltage dependency	Δf _{HO} /V _{CC}	f _{HO} =15.75kHz, f _{HO} 9.9V - f _{HC} 12.1V	—	40	130	Hz
f _{HO} ambient temperature dependency	Δf _{HO} /Ta	f _{HO} =15.75kHz, f _{HO} -20°C - f _{HC} 60°C	—	—	260	Hz
Oscillation frequency control sensitivity	β	ΔI _O = ±25μA	16	17.6	19.3	Hz/μA
DC loop gain	f _{DC}	μ × β	—	700	—	Hz/μs
Output pulse width	τ _{HO (1)}	V _{CC} =11V, R= 20kΩ, C= 6800pF	17.8	19.4	21.2	μs
Output pulse width	τ _{HO (2)}	V _{CC} =11V, R=20kΩ, C=330pF, 18000pF	2	—	40	μs
Output pulse width variation to supply voltage change	Δτ _{HO} /V _{CC}	V _{CC} = 9.9V to 12.1V	—	—	5	%
Output pulse width variation to temperature change	Δτ _{HO} /Ta	V _{CC} =11V, Ta= - 20°C to + 60°C	—	—	5	%
Oscillation output saturation voltage	V ₈₋₇	V _{CC} =11V, V _{I0-7} =1V	—	—	2	V
Oscillation output drive current	I ₈₋₇	V _{CC} =11V, V _{I0-7} =1V	300	—	—	mA
X-ray protecting circuit operation start voltage	V ₆₋₇	V _{CC} =11V	0.5	0.64	0.75	V

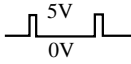
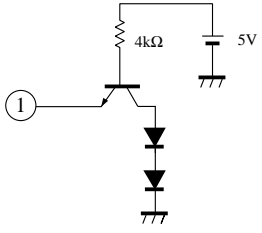
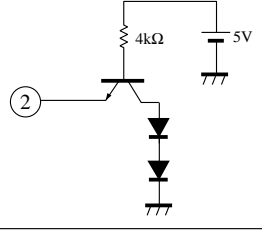

■ Application Circuit

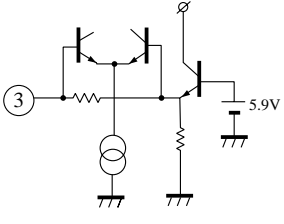
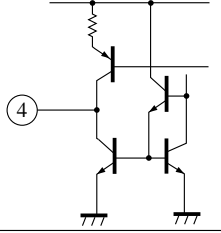
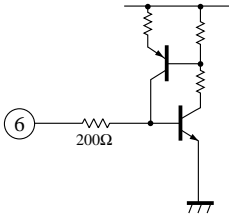

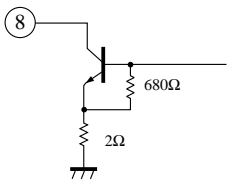
■ Pin Descriptions

Pin No.	Pin name	Typ. waveform	Description	Equivalent circuit
1	Horizontal synchronous signal input pin		Pin for inputting a horizontal synchronous signal.	
2	Polarity discrimination switching pin	DC	Both polarities of an input signal of Pin 1 are made available by connecting this pin to GND or setting it to OPEN	
3	Flyback pulse input pin		Flyback feedback pin. The standard value of amplitude is 1.5Vpp.	
4	AFC output pin	DC	Result of AFC detection.	
5	Supply voltage	DC	—————	—————
6	X-ray protecting circuit input pin	DC	When a voltage of 0.75V or more is applied, no horizontal output will not be generated.	
7	GND	DC	—————	—————
8	Horizontal drive output pin		Current when turned ON should be used at 300mA or less.	

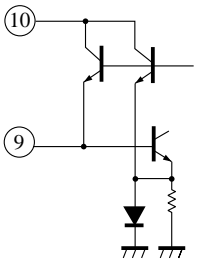
■ Pin Descriptions (cont.)

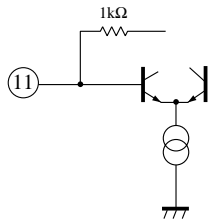
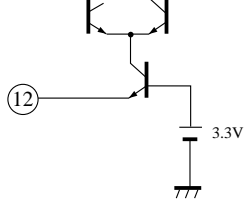
Pin No.	Pin name	Typ. waveform	Description	Equivalent circuit
9	Trigger input pin		The output pulse width can be changed by the capacitance between Pins9 and 10 and resistance between Pin10 and V_{CC} .	
10	Pulse width adjusting pin			
11	Sawtooth wave generating pin		Oscillation frequency can be changed by the capacitor to be connected to this pin.	
12	Horizontal oscillation circuit reference voltage	DC	Oscillation frequency is changed by the resistor between this pin and GND.	

Request for your special attention and precautions in using the technical information and semiconductors described in this material

- (1) An export permit needs to be obtained from the competent authorities of the Japanese Government if any of the products or technologies described in this material and controlled under the "Foreign Exchange and Foreign Trade Law" is to be exported or taken out of Japan.
- (2) The technical information described in this material is limited to showing representative characteristics and applied circuit examples of the products. It does not constitute the warranting of industrial property, the granting of relative rights, or the granting of any license.
- (3) The products described in this material are intended to be used for standard applications or general electronic equipment (such as office equipment, communications equipment, measuring instruments and household appliances).
Consult our sales staff in advance for information on the following applications:
 - Special applications (such as for airplanes, aerospace, automobiles, traffic control equipment, combustion equipment, life support systems and safety devices) in which exceptional quality and reliability are required, or if the failure or malfunction of the products may directly jeopardize life or harm the human body.
 - Any applications other than the standard applications intended.
- (4) The products and product specifications described in this material are subject to change without notice for reasons of modification and/or improvement. At the final stage of your design, purchasing, or use of the products, therefore, ask for the most up-to-date Product Standards in advance to make sure that the latest specifications satisfy your requirements.
- (5) When designing your equipment, comply with the guaranteed values, in particular those of maximum rating, the range of operating power supply voltage and heat radiation characteristics. Otherwise, we will not be liable for any defect which may arise later in your equipment.
Even when the products are used within the guaranteed values, redundant design is recommended, so that such equipment may not violate relevant laws or regulations because of the function of our products.
- (6) When using products for which dry packing is required, observe the conditions (including shelf life and after-unpacking standby time) agreed upon when specification sheets are individually exchanged.
- (7) No part of this material may be reprinted or reproduced by any means without written permission from our company.

Please read the following notes before using the datasheets

- A. These materials are intended as a reference to assist customers with the selection of Panasonic semiconductor products best suited to their applications.
Due to modification or other reasons, any information contained in this material, such as available product types, technical data, and so on, is subject to change without notice.
Customers are advised to contact our semiconductor sales office and obtain the latest information before starting precise technical research and/or purchasing activities.
- B. Panasonic is endeavoring to continually improve the quality and reliability of these materials but there is always the possibility that further rectifications will be required in the future. Therefore, Panasonic will not assume any liability for any damages arising from any errors etc. that may appear in this material.
- C. These materials are solely intended for a customer's individual use.
Therefore, without the prior written approval of Panasonic, any other use such as reproducing, selling, or distributing this material to a third party, via the Internet or in any other way, is prohibited.