

# SPECIFICATION

(TENTATIVE)

Device Name : IGBT

Type Name : 1MBH75D-060S

Spec. No. : MS5F 4623

Date : June-21-1999

This material and the information herein is the property of Fuji Electric Co., Ltd. They shall be neither reproduced, lent, or disclosed in any way whatsoever for the use of any third party nor used for the manufacturing purposes without the express written consent of Fuji Electric Co., Ltd.

Fuji Electric Co.,Ltd.  
Matsumoto Factory

	DATE	NAME	APPROVED	<b>Fuji Electric Co.,Ltd.</b>
DRAWN	June-21-99	<i>[Signature]</i>		MS5F 4623 <span style="float: right;">1/13</span>
CHECKED	Jun-21-99	T. HOSEN		
			T. HOSEN	Dwg. No. <span style="float: right;">1/13</span>

1MBH75D-060S

1. Outline Drawing

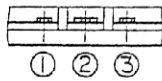
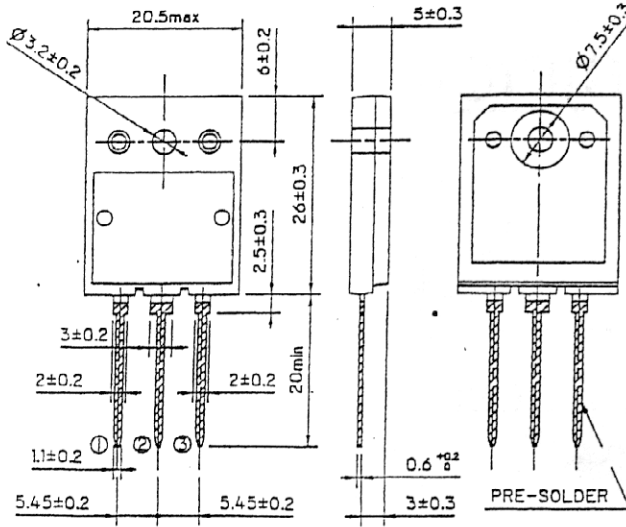

CONNECTION

- ① GATE
- ② COLLECTOR
- ③ EMITTER

2. Equivalent circuit

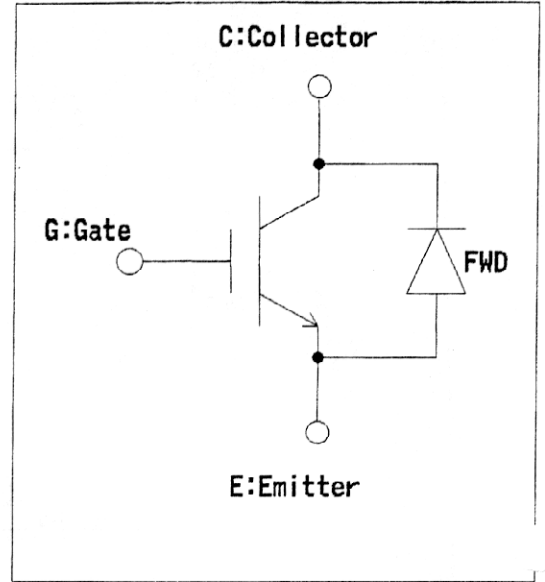

3. Absolute maximum ratings ( Tc=25°C )

Items	Symbols	Ratings	Units		
Collector-Emitter Voltage	$V_{CES}$	600	V		
Gate-Emitter Voltage	$V_{GES}$	±30	V		
Collector Current	DC	Tc=25 °C	$I_{C25}$	82	A
		Tc=100°C	$I_{C100}$	75	A
	1ms	Tc=25 °C	$I_{cp}$	225	A
IGBT Max. Power Dissipation	$P_c$	310	W		
FWD Max. Power Dissipation	$P_c$	180	W		
Operating Temperature	$T_j$	+ 150	°C		
Storage Temperature	$T_{stg}$	-40 ~ +150	°C		
Mounting Screw Torque	—	70	N · cm		

4. Electrical Characteristics ( at Tc=25°C unless otherwise specified )

Items		Symbols	Characteristics			Conditions	Unit	
			min.	typ.	max.			
Zero gate voltage Collector Current		$I_{CES}$	—	—	1.0	$V_{GE} = 0V$ $V_{CE} = 600V$	mA	
Gate-Emitter leakage Current		$I_{GES}$	—	—	10	$V_{CE} = 0V$ $V_{GE} = \pm 30V$	$\mu A$	
Gate-Emitter Threshold Voltage		$V_{GE(th)}$	4.0	5.0	6.0	$V_{CE} = 20V$ $I_c = 75mA$	V	
Collector-Emitter Saturation Voltage		$V_{CE(sat)}$	—	2.4	2.9	$V_{GE} = 15V$ $I_c = 75A$	V	
Input capacitance		$C_{ies}$	—	3700	—	$V_{GE} = 0V$	pF	
Output capacitance		$C_{oes}$	—	350	—	$V_{CE} = 25V$		
Reverse transfer capacitance		$C_{res}$	—	190	—	$f = 1MHz$		
Switching Time	Turn-on time	$t_{on} *$	—	0.15	—	$V_{CC} = 300V$ $I_c = 75A$ $V_{GE} = \pm 15V$ $R_G = 24 \Omega$ (Half Bridge)	$\mu S$	
		$t_r *$	—	0.09	—			
		$t_{rr2}$	—	0.03	—			
	Turn-off time	$t_{off}$	—	0.50	0.62			Inductance Load
		$t_f$	—	0.10	0.17			
	Turn-on time	$t_{on} *$	—	0.15	—			$V_{CC} = 300V$ $I_c = 75A$ $V_{GE} = +15V$ $R_G = 6.0 \Omega$ (Half Bridge)
			$t_r *$	—	0.09	—		
			$t_{rr2}$	—	0.03	—		
		Turn-off time	$t_{off}$	—	0.50	0.62		
			$t_f$	—	0.10	0.17		
	FWD forward voltage		$V_F$	—	2.0	2.5	$I_F = 75A, V_{GE} = 0V$	
Reverse recovery time		$t_{rr}$	—	0.06	0.10	$I_F = 75A, V_{GE} = -10V$ $V_R = 300V,$ $dv/dt = 100A/\mu S$	$\mu S$	

\* Turn-on characteristics include  $t_{rr2}$ . See figure.A in next page.

### 5. Thermal resistance characteristics

Items	Symbols	Characteristics			Conditions	Unit
		min.	typ.	max.		
Thermal resistance	Rth(j-c)	—	—	0.40	IGBT	°C/W
	Rth(j-c)	—	—	0.69	FWD	

### 6. Switching waveform

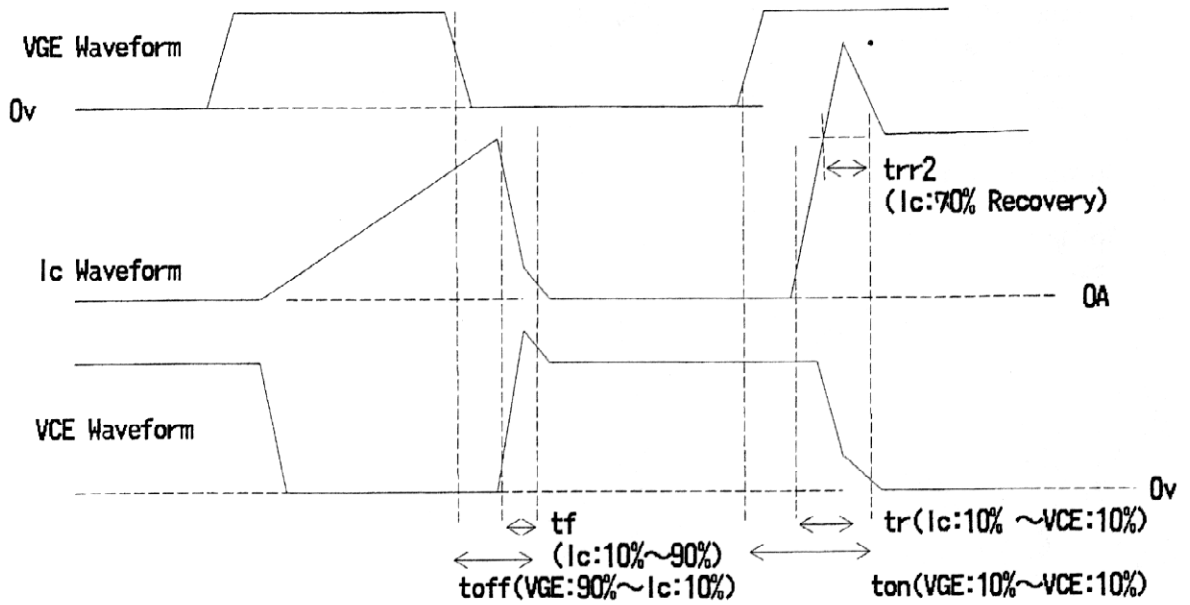

Collector Current vs. Collector-Emitter Voltage  
 $T_j = 25^\circ\text{C}$

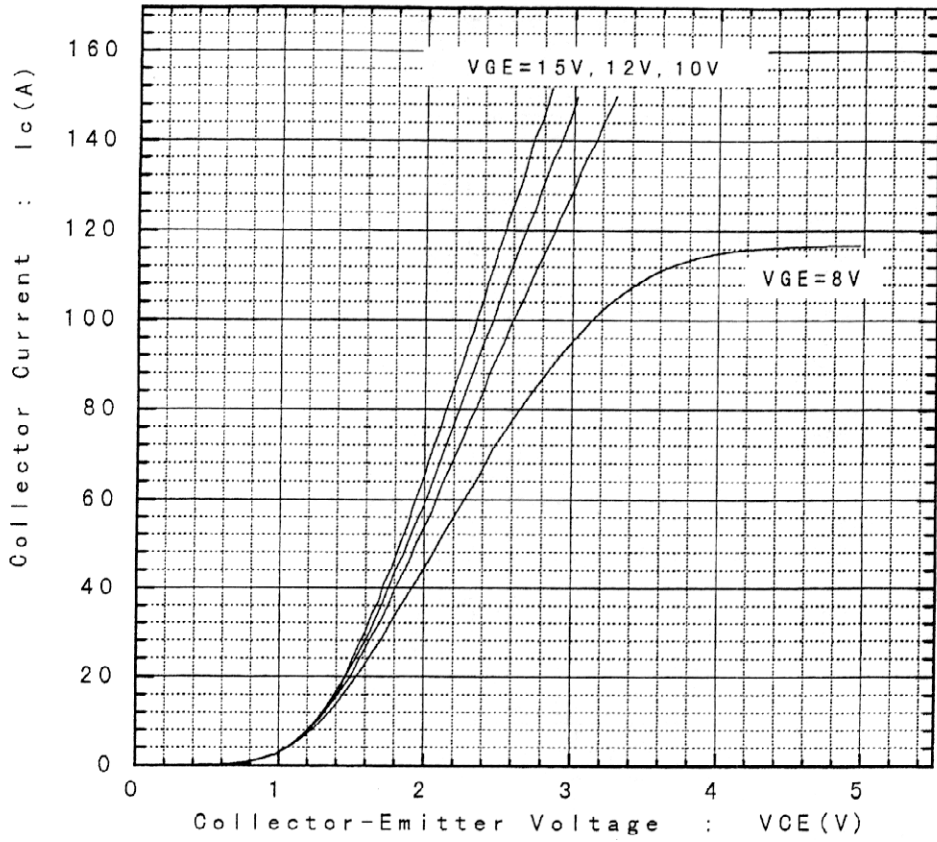

Collector Current vs. Collector-Emitter Voltage  
 $T_j = 125^\circ\text{C}$

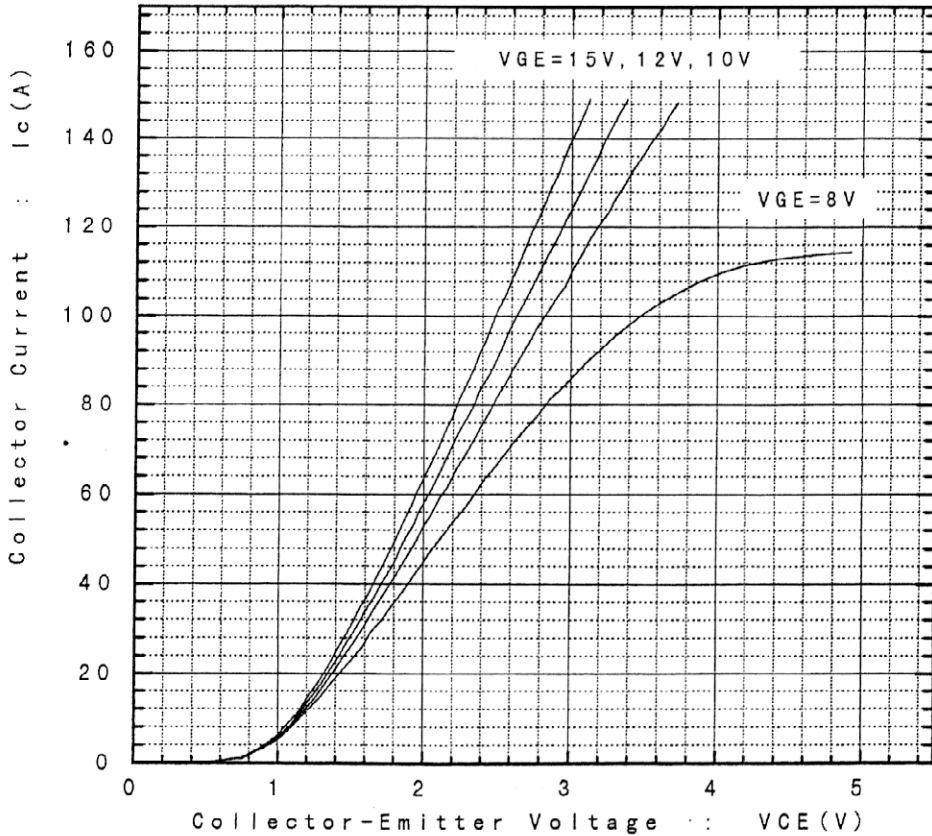

This material and the information herein is the property of Fuji Electric Co., Ltd. It shall be neither reproduced, copied, or disclosed in any way whatsoever for the use of any third party nor used for the manufacturing purposes without the express written consent of Fuji Electric Co., Ltd.

Collector-Emitter Voltage vs Gate-Emitter Voltage  
 $T_j=25^\circ\text{C}$

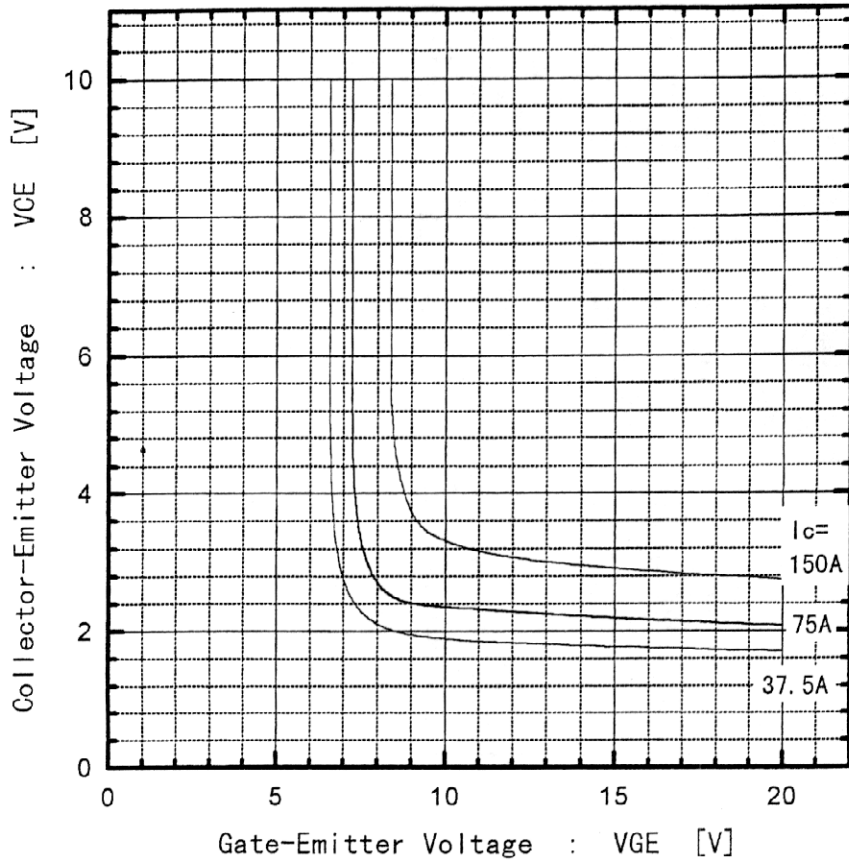

Collector-Emitter Voltage vs Gate-Emitter Voltage  
 $T_j=125^\circ\text{C}$

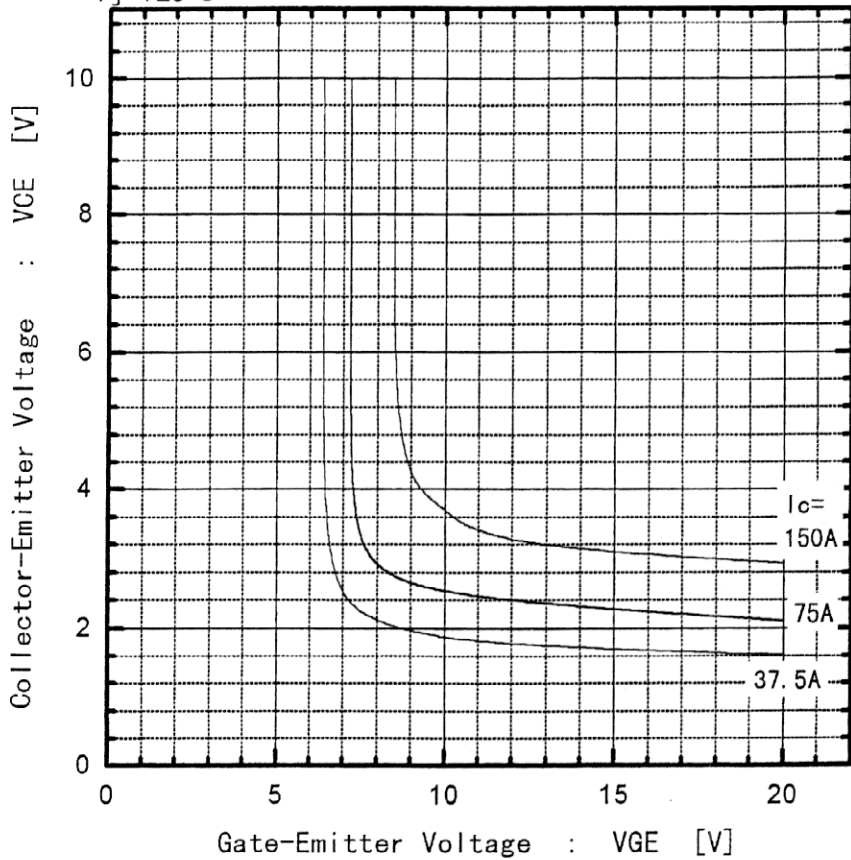

This material and the information herein is the property of Fuji Electric Co., Ltd. They shall be neither reproduced, copied, lent, or disclosed in any way whatsoever for the use of any third party nor used for the manufacturing purposes without the express written consent of Fuji Electric Co., Ltd.

This material and the information herein is the property of Fuji Electric Co., Ltd. They shall be neither reproduced, copied, lent, or disclosed in any way whatsoever for the use of any third party nor used for the manufacturing purposes without the express written consent of Fuji Electric Co., Ltd.

Switching time vs Collector current

$V_{cc}=300V, R_G=6\ \Omega, V_{GE}=+15V, T_j=125^\circ C$

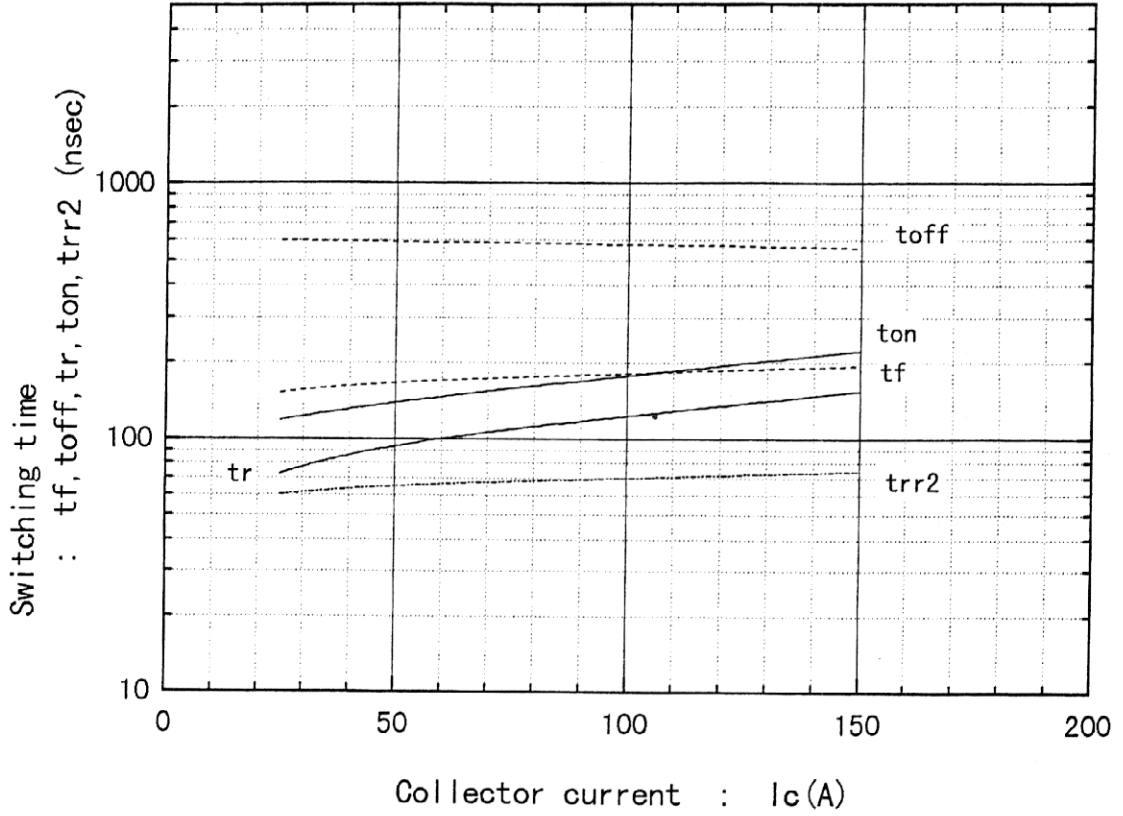

Switching time vs Collector current

$V_{cc}=300V, R_G=24\ \Omega, V_{GE}=\pm 15V, T_j=125^\circ C$

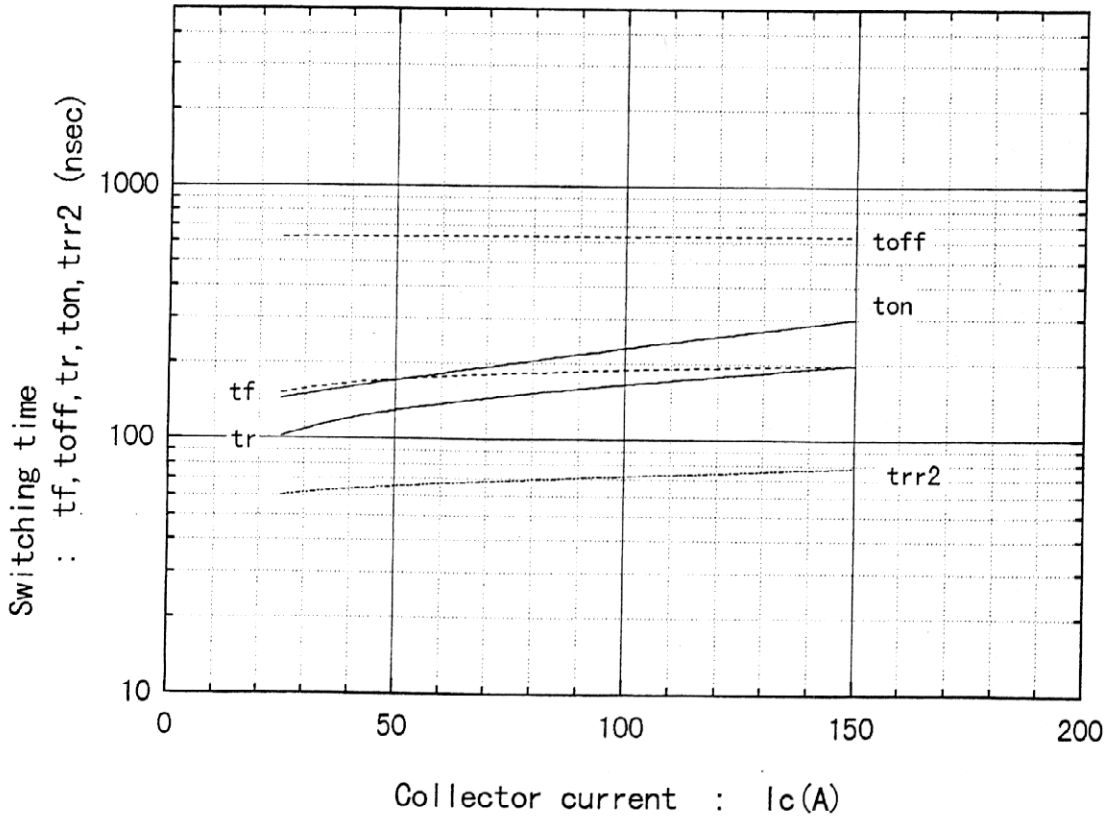

Fuji Electric Co., Ltd.

DWG. NO.

MS5F 4623

7/13

This material and the information herein is the property of Fuji Electric Co., Ltd. They shall be neither reproduced, copied, lent, or disclosed in any way whatsoever for the use of any third party nor used for the manufacturing purposes without the express written consent of Fuji Electric Co., Ltd.

### Switching time vs RG

$V_{cc}=300V, I_c=75A, V_{GE}=+15V, T_j=125^{\circ}C$

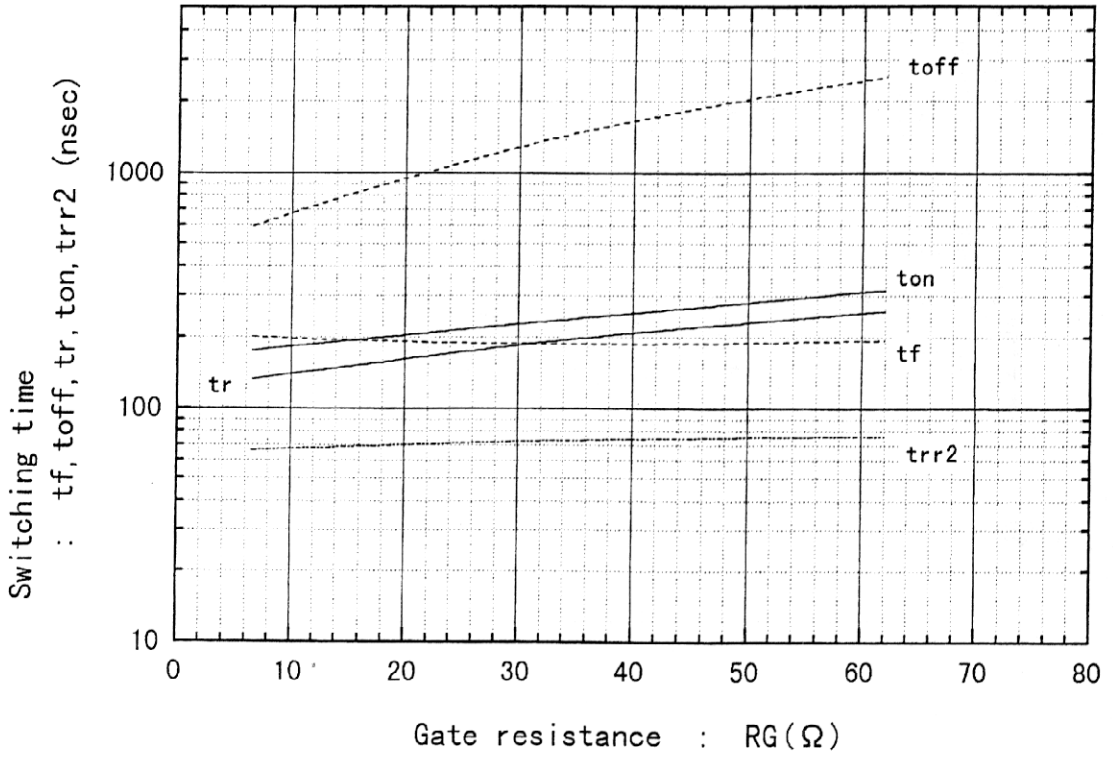

### Switching time vs RG

$V_{cc}=300V, I_c=75A, V_{GE}=\pm 15V, T_j=125^{\circ}C$

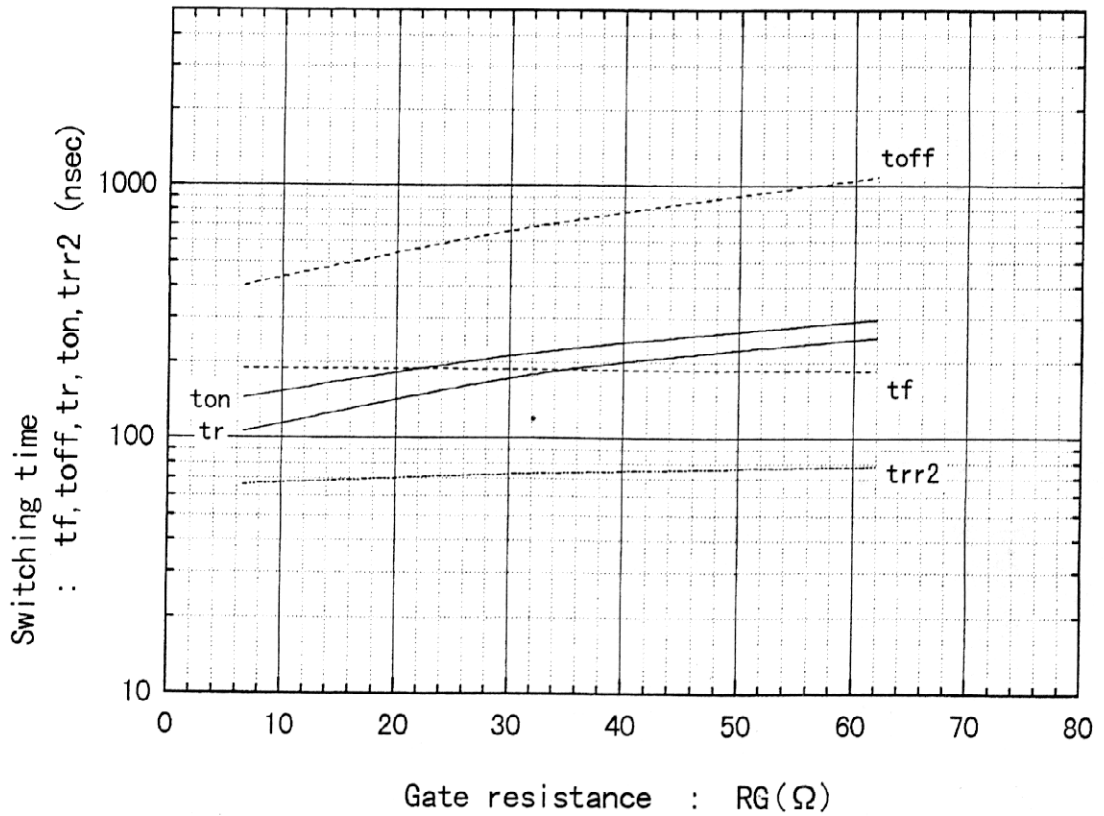



This material and the information herein is the property of Fuji Electric Co., Ltd. They shall be neither reproduced, copied, lent, or disclosed in any way whatsoever for the use of any third party nor used for the manufacturing purposes without the express written consent of Fuji Electric Co., Ltd.

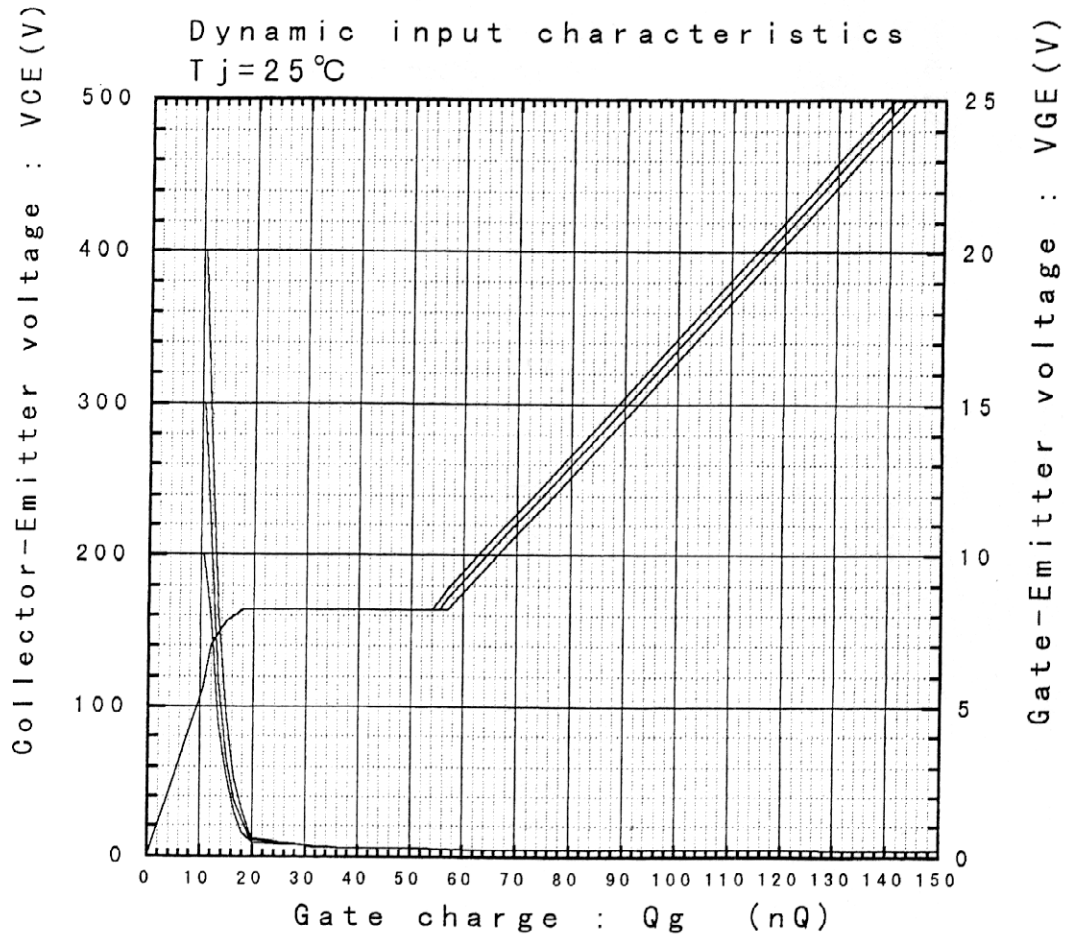

### Capacitance vs. Collector-Emitter Voltage $T_j = 25^\circ\text{C}$

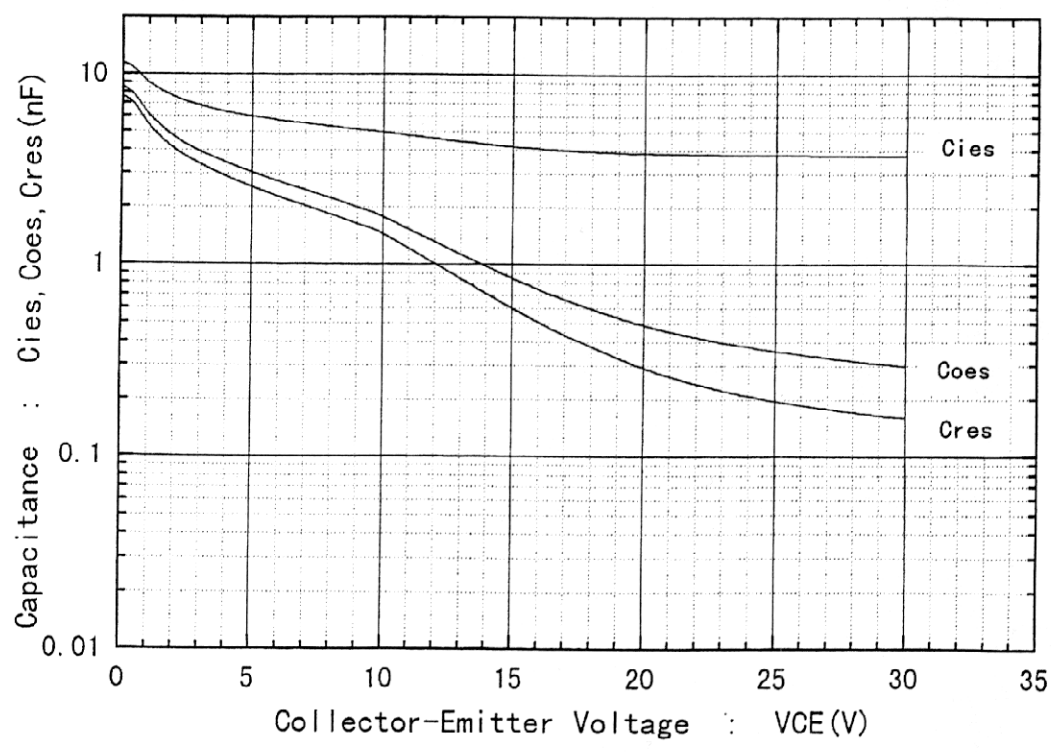

**Fuji Electric Co., Ltd.**

DRG. NO.

MS5F 4623

9/13

This material and the information herein is the property of Fuji Electric Co., Ltd. They shall be neither reproduced, copied, lent, or disclosed in any way whatsoever for the use of any third party nor used for the manufacturing purposes without the express written consent of Fuji Electric Co., Ltd.

1MBH75D-060S  
 Reverse Biased Safe Operating Area  
 $R_G=6\ \Omega$ ,  $+V_{GE}\leq 30V$ ,  $-V_{GE}=15V$ ,  $T_j\leq 125^\circ C$

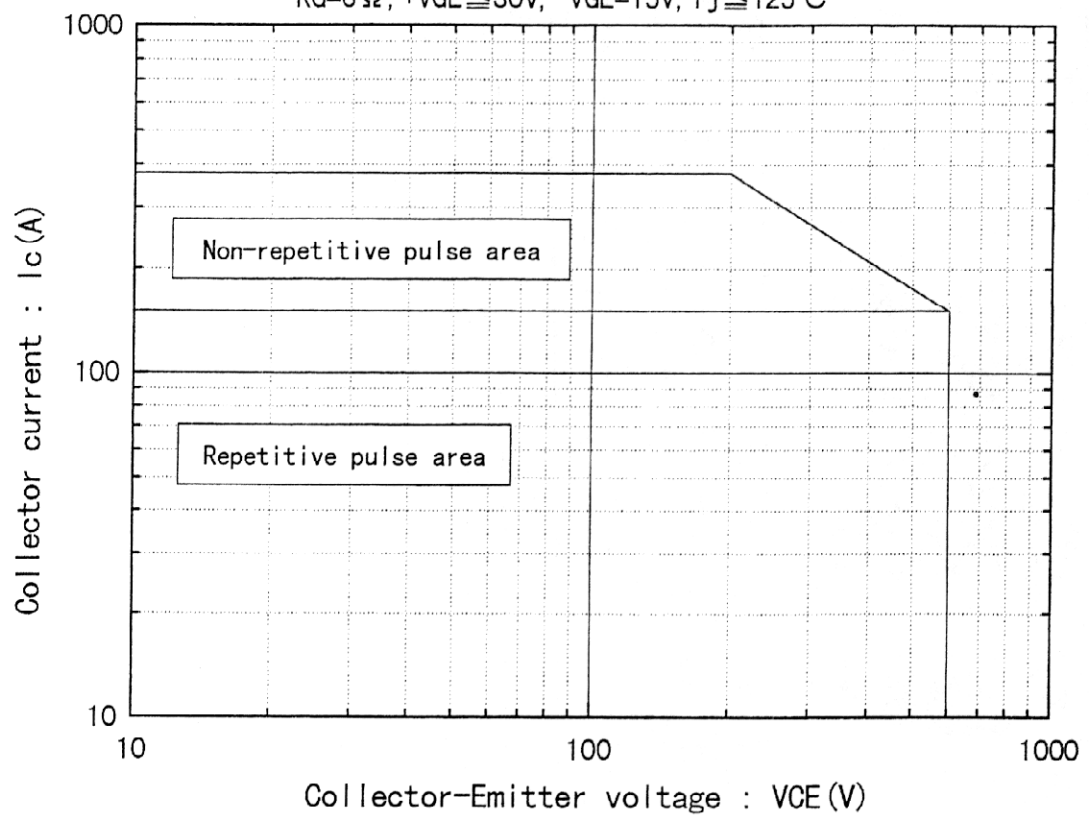

1MBH75D-060S  
 Forward Bias Safe Operating Area

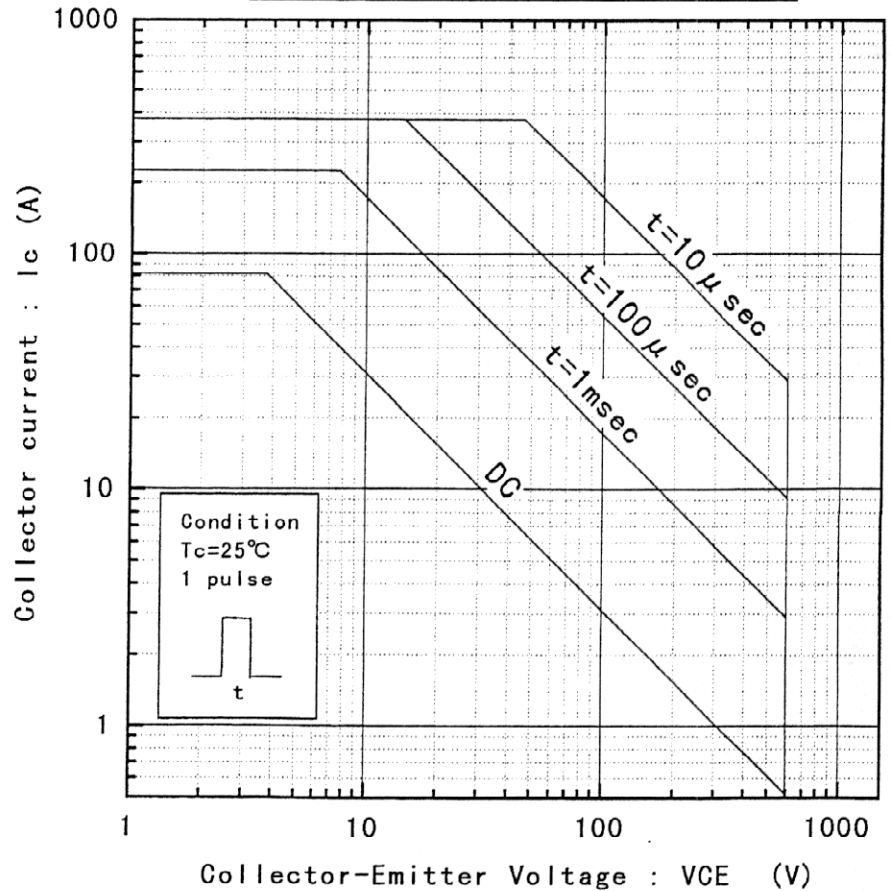

Fuji Electric Co., Ltd.

Dwg. No.

MS5F 4623

10/13

This material and the information herein is the property of Fuji Electric Co., Ltd. They shall be neither reproduced, copied, lent, or disclosed in any way whatsoever for the use of any third party nor used for the manufacturing purposes without the express written consent of Fuji Electric Co., Ltd.

Reverse recovery time vs. Forward current  
VR=300V, -di/dt=100A/ $\mu$  sec

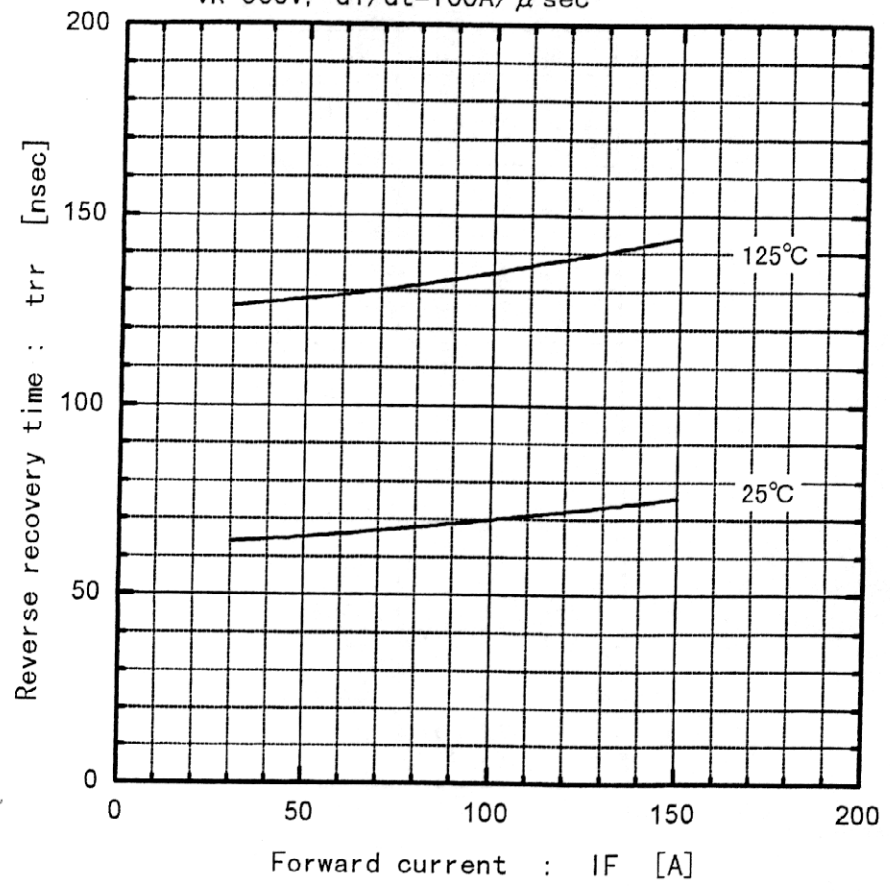

Reverse recovery current vs. Forward current  
VR=300V, -di/dt=100A/ $\mu$  sec

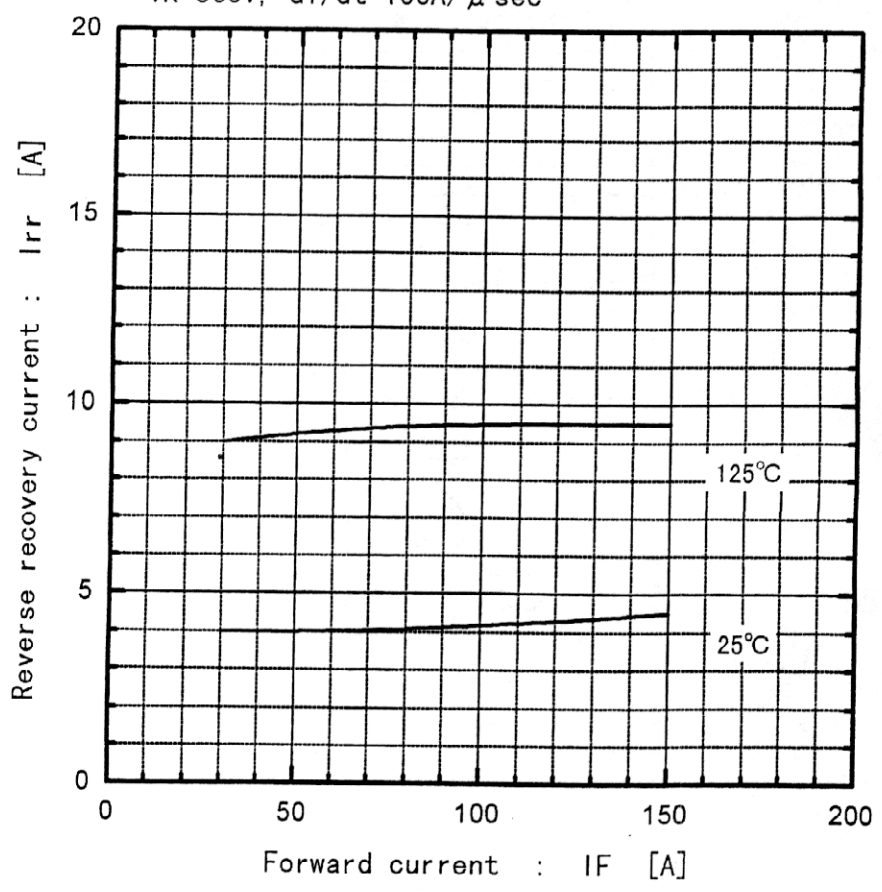

This material and the information herein is the property of Fuji Electric Co., Ltd. They shall be neither reproduced, copied, lent, or disclosed in any way whatsoever for the use of any third party nor used for the manufacturing purposes without the express written consent of Fuji Electric Co., Ltd.

Forward Voltage vs. Forward current

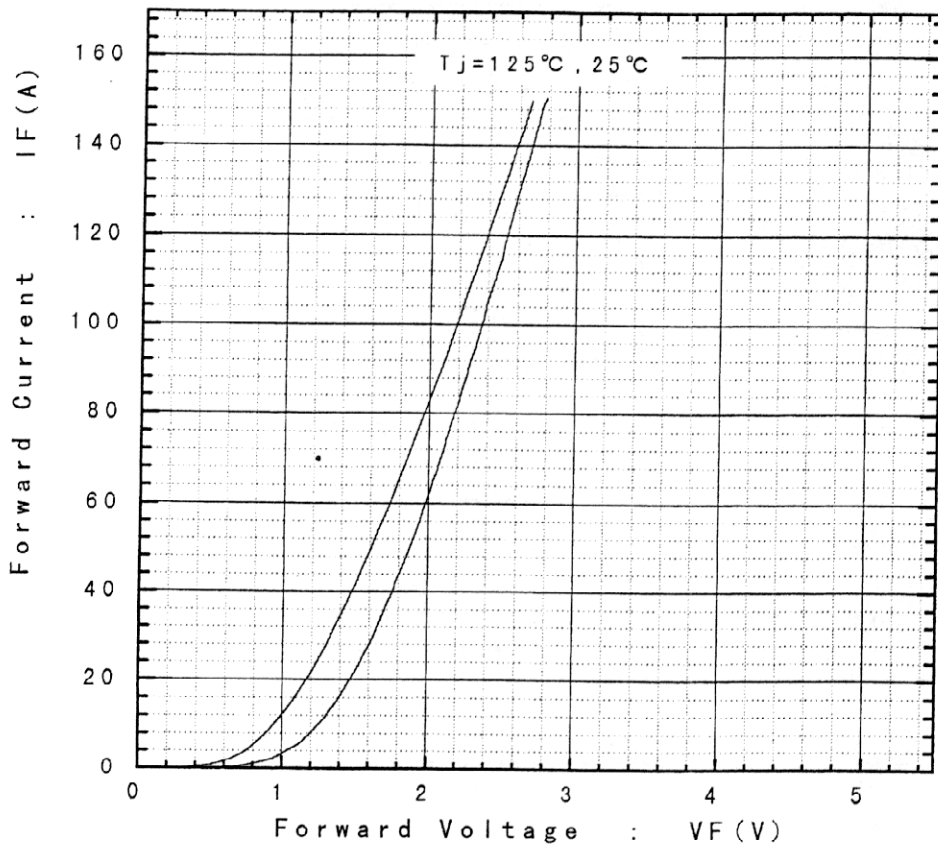

Reverse recovery characteristics vs.  $-di/dt$   
 $V_R=300V, I_F=75A, T_j=125^\circ C$

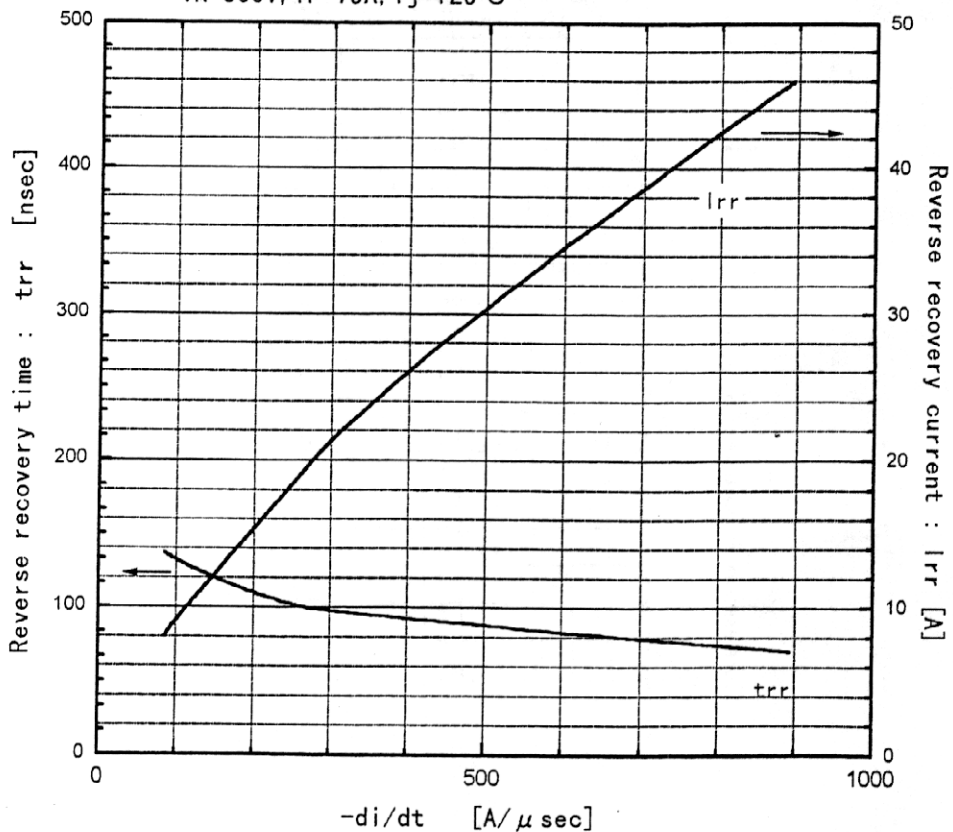

Fuji Electric Co., Ltd.

FIG. NO.

MS5F 4623

12/13

# Transient thermal resistance

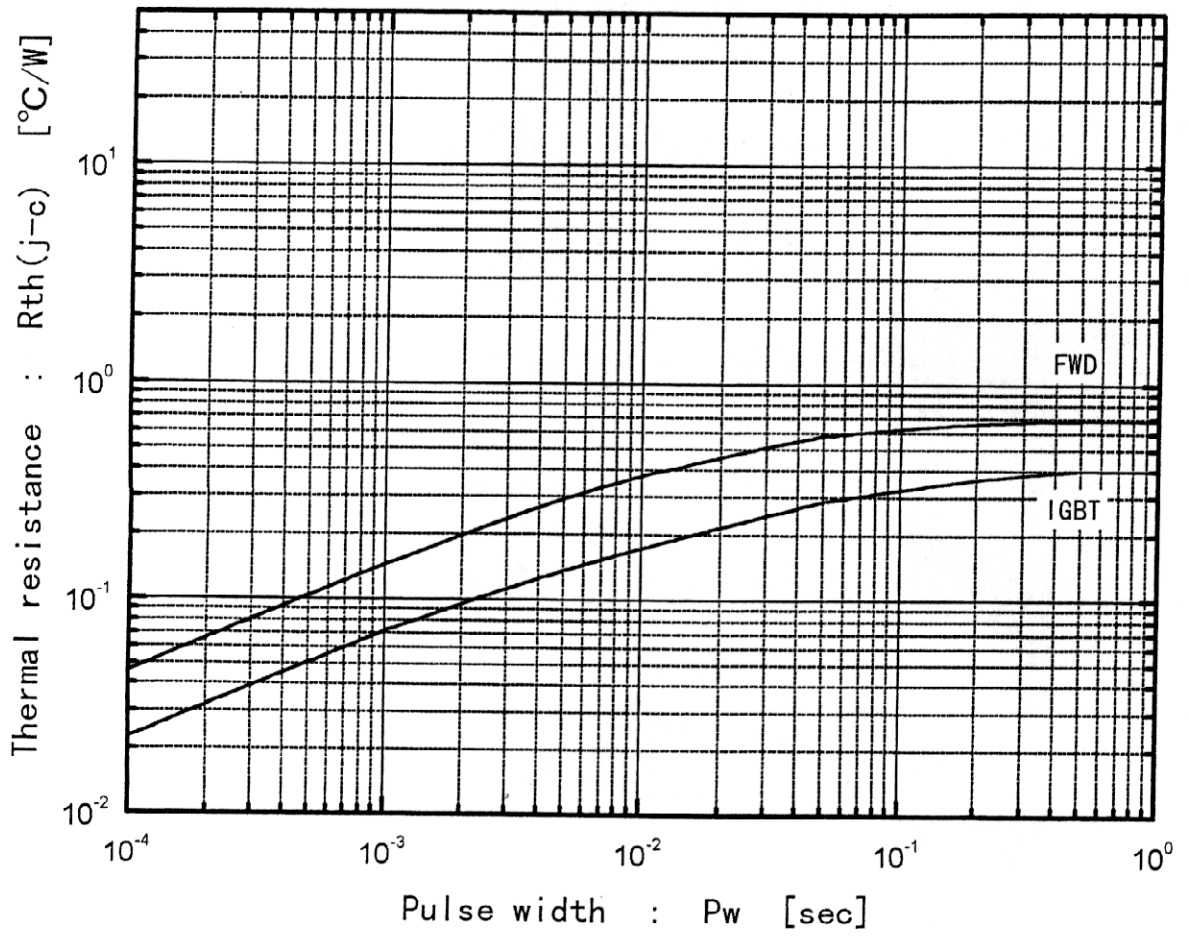

This material and the information herein is the property of Fuji Electric Co., Ltd. They shall be neither reproduced, copied, lent, or disclosed in any way whatsoever for the use of any third party nor used for the manufacturing purposes without the express written consent of Fuji Electric Co., Ltd.

**Fuji Electric Co., Ltd.**

DWG. NO.

MS5F 4623

13/13