

Standard Products

ACT4404N Single Transceiver

for MACAIR (A3818, A4905, A5232, A5690), MIL-STD-1553
& SAE-AS15531

www.aeroflex.com/Avionics

March 4, 2005



FEATURES

- ACT4404N transceiver meets MIL-STD-1553A & B, Macair A3818, A4905, A5232 and A5690 specs
- Bipolar supply $\pm 15V$ to $\pm 12V$, logic supply +5V
- Monolithic construction
- Direct replacement for CT3232M
- Voltage source output for higher bus drive power
- Variable receiver threshold capability
- Designed for commercial, industrial and aerospace applications
- MIL-PRF-38534 compliant devices available
- Aeroflex-Plainview is a Class H & K MIL-PRF-38534 manufacturer

GENERAL DESCRIPTION

The Aeroflex-Plainview transceiver model ACT4404N is a new generation monolithic transceiver which provide full compliance with Macair and MIL-STD-1553 data bus requirements.

The model ACT4404N performs the front-end analog function of inputting and outputting data through a transformer to a MIL-STD-1553 or Macair data bus. The ACT4404N can be considered a "Universal" Transceiver in that it is compatible with MIL-STD-1553A/B, Macair (A-3818, A-4905, A-5232 and A-5690).

Design of these transceivers reflects particular attention to active filter performance. This results in low bit and word error rate with superior waveform purity and minimal zero crossover distortion. The ACT4404N active filter design has additional high frequency roll-off to provide the required Macair low harmonic distortion waveform without increasing the pulse delay characteristics significantly.

Efficient transmitter electrical and thermal design provides low internal power dissipation and heat rise at high and well as low duty cycles. An optional receiver input threshold adjustment can be accomplished by the use of the "External Threshold" terminals.

TRANSMITTER

The Transmitter section accepts bi-phase TTL data at the input and when coupled to the data bus with a 1:1 transformer the data bus signal produced is 7.0 Volts typical P-P at point A-A' (See Figure 3 or 4). When both DATA and $\overline{\text{DATA}}$ inputs are held low or high, the transmitter output becomes a high impedance and is "removed" from the line. In addition, an overriding "INHIBIT" input provides for the removal of the transmitter output from the line. A logic "1" applied to the "INHIBIT" takes priority over the condition of the data inputs and disables the transmitter (See Transmitter Logic Waveforms - Figure 1).

The transmitter utilizes an active filter to suppress harmonics above 1 MHz to meet Macair specifications A-3818, A-4905, A-5232 and A-5690. The transmitter may be safely operated for an indefinite period at 100% duty cycle into a data bus short circuit.

The transceiver utilizes an active filter to suppress harmonics above 1MHz. The Transmitter may be safely operated at 100% duty cycle for an indefinite period into a short circuited 1553 bus.

RECEIVER

The Receiver section accepts bi-phase differential data at the input and produces two TTL signals at the output. The outputs are DATA and $\overline{\text{DATA}}$, and represent positive and negative excursions of the input beyond a pre-determined threshold (See Receiver Logic Waveforms - Figure 2).

The internal threshold is nominally set to detect data bus signals exceeding 1.05 V_{p-p} and reject signals less than 0.6 V_{p-p} when used with a 1:1 turns ratio transformer (See Figure 3 or 4 for transformer data and typical connection). This threshold setting can be held by grounding the appropriate pins or modified with the use of external resistors.

A low level at the "STROBE" input inhibits the DATA and $\overline{\text{DATA}}$ outputs. If unused, a 2K Ohm pull-up to +5VDC is recommended.

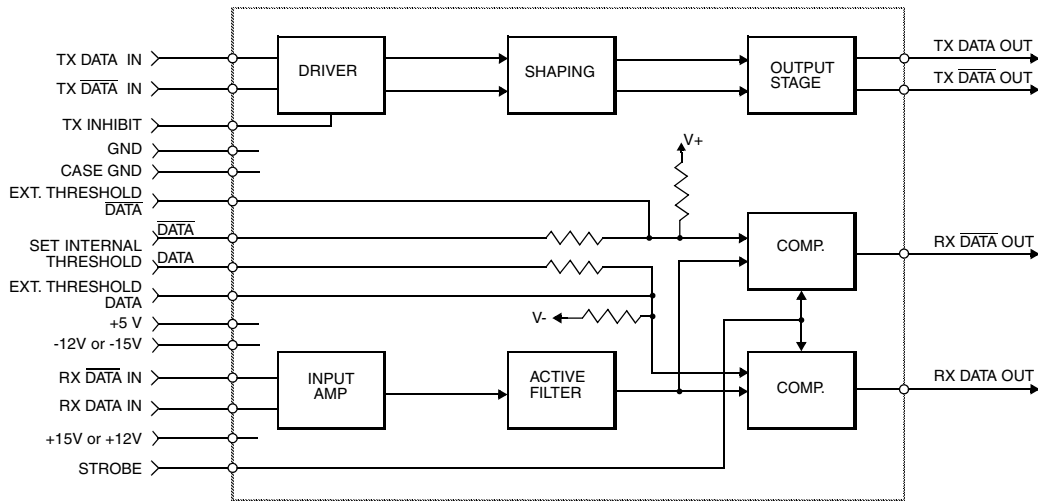

BLOCK DIAGRAM (WITHOUT TRANSFORMER)

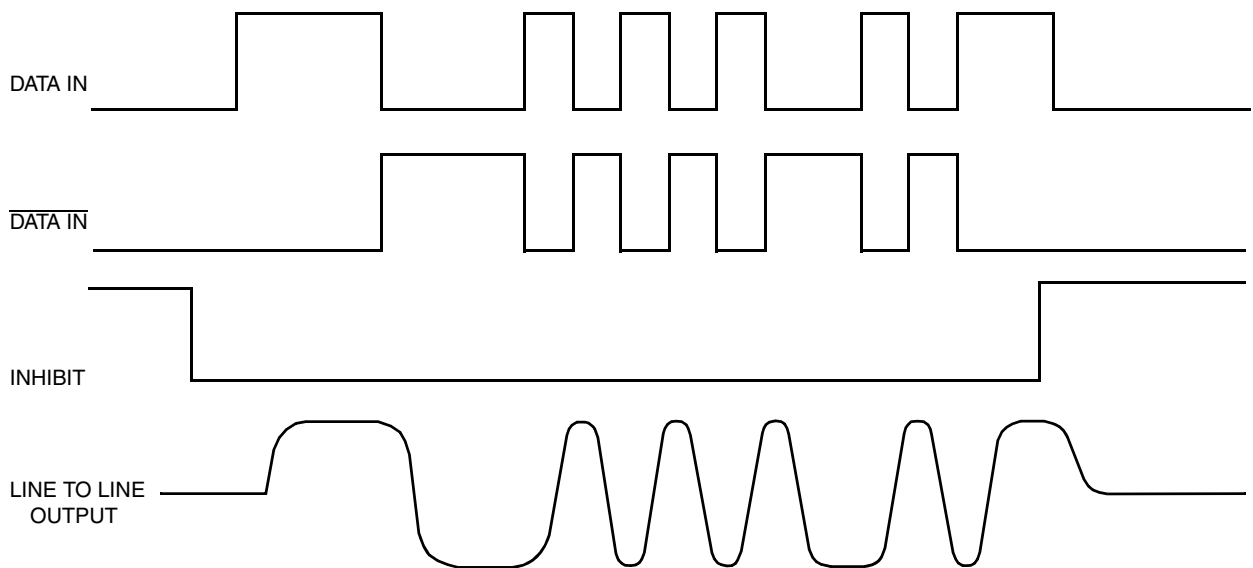

- Notes:
1. Line to line waveforms illustrate Macair signals, MIL-STD-1553 signals are trapezoidal.
 2. DATA and $\overline{\text{DATA}}$ inputs must be complementary waveforms or 50% duty cycle average, with no delays between them.
 3. DATA and $\overline{\text{DATA}}$ must be in the same state during off time (both high or low).

FIGURE 1 – TRANSMITTER LOGIC WAVEFORMS IDEALIZED

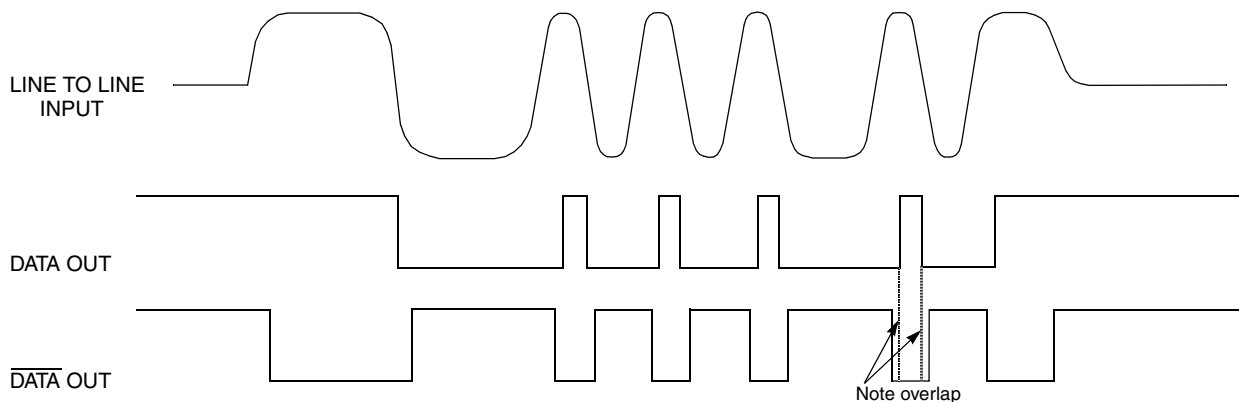

- Notes:
1. Normally high output in standby.

FIGURE 2 – RECEIVER LOGIC WAVEFORMS IDEALIZED

ABSOLUTE MAXIMUM RATINGS

Operating Case Temperature	-55°C to +125°C	
Storage Case Temperature	-65°C to +150°C	
Power Supply Voltages	±15VDC to ±18VDC	+5VDC to +7VDC
Logic Input Voltage	-0.3 V to +5.5 V	
Receiver Differential Input	±40 V	
Receiver Input Voltage (Common Mode)	±10V	
Driver Peak Output Current	150 mA	
Total Package Power Dissipation over the Full Operating Case Temperature Range *	3.25 Watts	
Maximum Junction to Case Temperature (100% duty cycle)	16.25°C	
Junction-Case, Thermal Resistance	5°C/W	

* See Aeroflex Application Note # 112 for reference.

ELECTRICAL CHARACTERISTICS – DRIVER SECTION 1/2/

INPUT CHARACTERISTICS, TX DATA IN OR TX DATA IN

Parameter	Condition	Symbol	Min	Typ	Max	Unit
"0" Input Current	$V_{IN} = 0.4V$	I_{ILD}	-	-0.2	-0.4	mA
"1" Input Current	$V_{IN} = 2.7V$	I_{IHD}	-	1	40	μA
"0" Input Voltage	-	V_{ILD}	-	-	0.7	V
"1" Input Voltage	-	V_{IHD}	2.0	-	-	V

INHIBIT CHARACTERISTICS

"0" Input Current	$V_{IN} = 0.4V$	I_{ILI}	-	-0.1	-0.2	mA
"1" Input Current	$V_{IN} = 2.7V$	I_{IHI}	-	1.0	40	μA
"0" Input Voltage	-	V_{ILI}	-	-	0.7	V
"1" Input Voltage	-	V_{IHI}	2	-	-	V
Delay from TX inhibit, (0→1) to inhibited output	Note 1	t_{DXOFF}	-	350	700	nS
Delay from TX inhibit, (1→0) to active output	Note 1	t_{DXON}	-	300	500	nS
Differential Output Noise, inhibit mode	-	V_{NOI}	-	0.8	10	mVp-p
Differential Output Impedance (inhibited) *	Note 2	Z_{OI}	10K	-	-	Ω

* See Aeroflex Application Note # 113 for reference.

OUTPUT CHARACTERISTICS

Differential output Level, Figure 3 Point B-B'	$Z_O = 70\Omega$	V_O	18	21	24	V_{p-p}
Output offset at point A-A on Figures 3 or 4, 2.5μS after midpoint crossing of the last bit		V_{OS}	-	-	±90	mVpeak
Output rise / fall times (10% to 90% of p-p output)		t_R & t_F	200	250	300	nS
Delay from 50% point of TX DATA or TX \overline{DATA} input to zero crossing of differential output (Note 1)		t_{DTX}	-	220	350	nS

ELECTRICAL CHARACTERISTICS – RECEIVER SECTION 1/ 2/

Parameter	Condition	Symbol	Min	Typ	Max	Unit
Differential Input Impedance	f = 1MHz	Z _{IN}	10K	-	-	Ω
Differential Input Voltage Range	-	V _{IDR}	-	-	40	V _{p-p}
Input Common Mode Voltage Range	-	V _{ICR}	10	-	-	V _{p-p}
Common Mode Rejection Ratio	-	CMRR	40	-	-	dB

STROBE CHARACTERISTICS (LOGIC "0" INHIBITS OUTPUT)

"0" Input Current	V _S = 0.4V	I _{IL}	-	-0.2	-0.4	mA
"1" Input Current	V _S = 2.7V	I _{IH}	-	1	+40	μA
"0" Input Voltage	-	V _{IL}	-	-	0.7	V
"1" Input Voltage	-	V _{IH}	2.0	-	-	V
Strobe Delay (Turn-on or Turn-off)	-	t _{SD}	-	40	150	nS

THRESHOLD CHARACTERISTICS (SINEWAVE INPUT)

Internal Threshold Voltage Figure 3	Point B - B' 1MHz	V _{TH}	0.60	0.80	1.10	V _{p-p}
-------------------------------------	----------------------	-----------------	------	------	------	------------------

OUTPUT CHARACTERISTICS, RX DATA AND RX $\overline{\text{DATA}}$

"1" State	I _{OH} = -0.4 mA	V _{OH}	2.5	3.6	-	V
"0" State	I _{OL} = 4 mA	V _{OL}	-	0.35	0.5	V
Receiver Output Skew	Note 6	t _{RXSK}	-	-	10	nS
Delay (average), from differential input zero crossings to RX DATA and RX $\overline{\text{DATA}}$ output 50% points	Note 7	t _{DRX}	-	300	450	nS

POWER SUPPLY CURRENT 1/ 2/

Duty Cycle	Condition	Symbol	Typ	Max	Unit		
Transmitter Standby	Point B-B', Z _O = 70 Ω, V _O = 29 VP-P Bit Pattern = FFFF _{HEX} Figure 4	I _{CC}	5	10	mA		
25%		I _{EE}	25	35			
		I _L	18	30			
		I _{CC}	20	30			
50%		I _{EE}	40	60			
		I _L	18	30			
		I _{CC}	40	60			
100%		I _{EE}	60	80			
		I _L	18	30			
		I _{CC}	85	120			
			I _{EE}	105		140	
			I _L	18		30	

TYPICAL HYBRID POWER DISSIPATION *

Power Supply Conditions	Condition	Standby	100% Duty Cycle	Unit
PSC1 V _{CC} = +15V V _{EE} = -15V V _L = +5V	Point B-B', Z _O = 70 Ω, V _O = 29 VP-P Bit Pattern = FFFF _{HEX} Figure 4	0.540	2.167	Watts
PSC2 V _{CC} = +15V V _{EE} = -12V V _L = +5V		0.465	1.852	
PSC3 V _{CC} = +12V V _{EE} = -12V V _L = +5V		0.450	1.600	

* See Aeroflex Application note# 112 for reference.

Recommended Power Supply Voltage Range

+V	+11.4 Volts to +15.75 Volts
-V	-11.4 Volts to -15.75 Volts
Logic	+4.5 Volts to +5.5 Volts

Notes:

- V_{CC} = +15VDC ±0.75V, V_{EE} = -15V. V_{CC} = +15VDC ±0.75V, V_{IL} = +5VDC ±0.5V, T_C = -55°C to +125°C, unless otherwise specified.
- All typical values are measured at +25°C.
- Characteristics guaranteed by design, not production tested.
- Power ON/OFF, measured from 75KHz to 1MHz at Point A-A' Figure 4, in accordance with MIL-STD-1553B paragraph 4.5.2.2.2.3.
- At point A-A' on Figure 3 or 4, 2.5μS after midpoint crossing of the parity bit of the last word of a 660 μS message.
- Receiver skew is defined as the time from the rising edge of RX DATA OUT to the rising edge of RX $\overline{\text{DATA}}$ OUT minus 500 nS, with a sine wave input of 3 VP-P at 1MHz driven into Point B-B' of Figure 4 or 2.1 VP-P at 1MHz driven into Point B-B' of Figure 3. The specification maximum is guaranteed for T_A = 25°C only. Standard TTL loads applied to RX DATA Outputs.
- This test is performed while the Transceiver is reading its own transmission. This condition is called "Wraparound". Standard TTL loads applied to RX DATA Outputs.

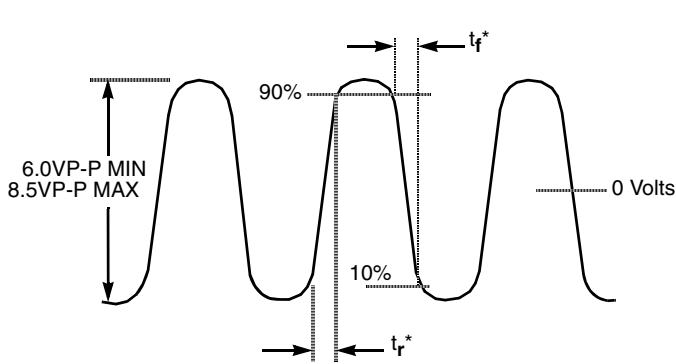

* Rise and fall times measured at point A-A' in Figure 3

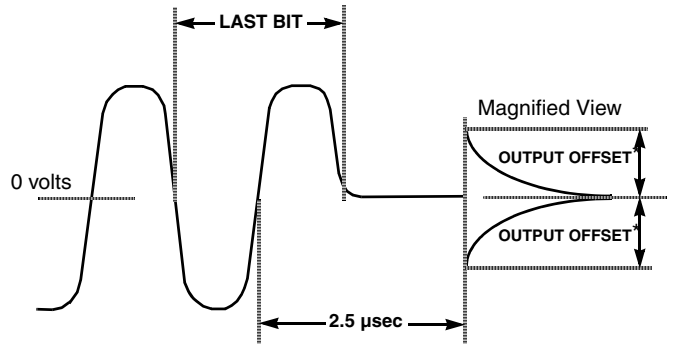

* Offset measured at point A-A' in Figure 3

FIGURE 5 – TRANSMITTER (TX) OUTPUT WAVEFORM

FIGURE 6 – TRANSMITTER (TX) OUTPUT OFFSET

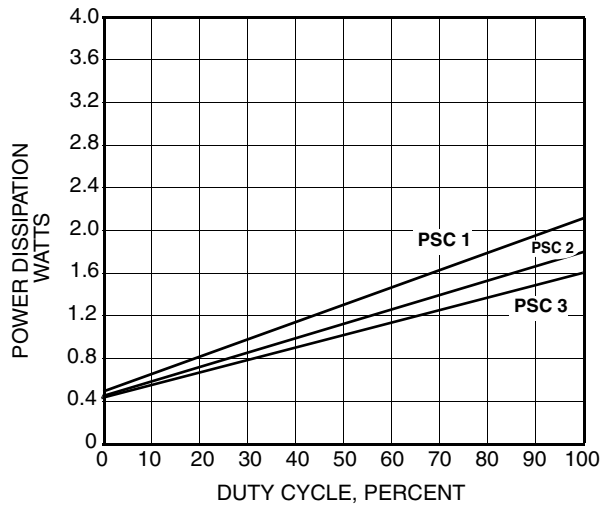
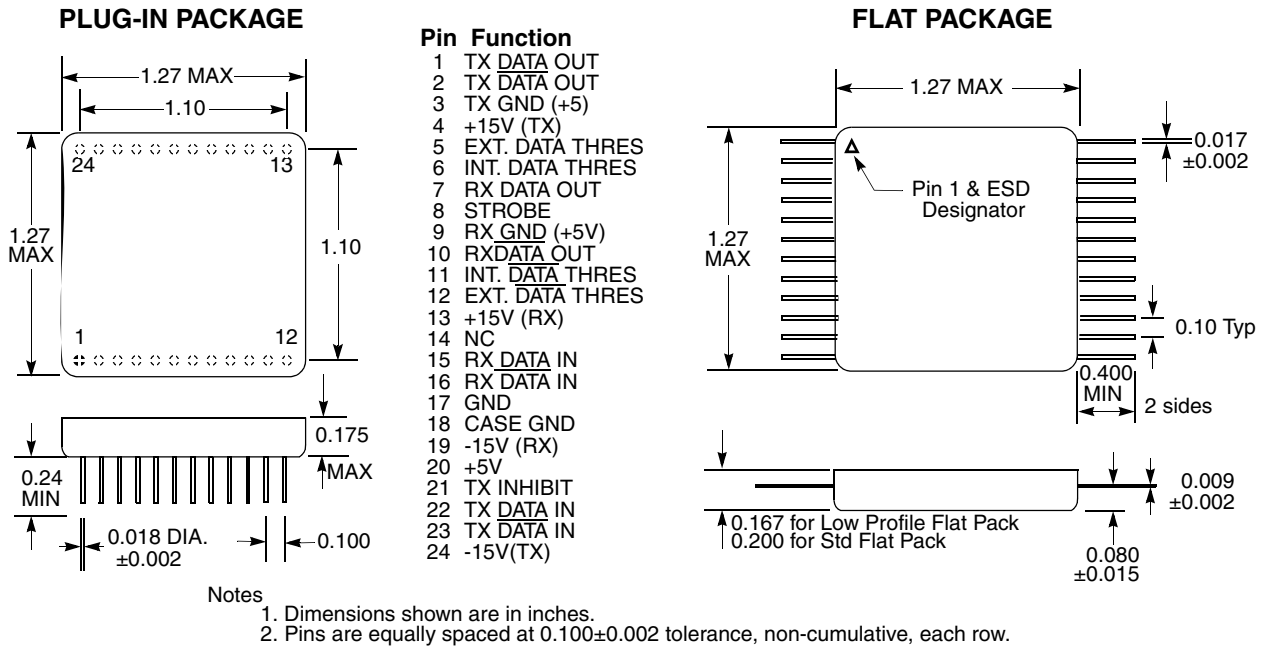

FIGURE 7 – TYPICAL POWER DISSIPATION vs. DUTY CYCLE

CONFIGURATIONS AND ORDERING INFORMATION

Model No.	Receiver Data level	Configuration
ACT4404N	Normally High	Plug In
ACT4404N-2	Normally High	Flat Pack
<p>Special Note</p> <p style="text-align: center;">Use the ACT4404N To replace the ARX4404, ARX3404* & CT3232M</p> <p>* When replacing the ARX3404 Pins 6 & 11 must be grounded. Pins were no connect in the ARX3400 Series.</p>		

PACKAGE CONFIGURATION OUTLINE



PLAINVIEW, NEW YORK
Toll Free: 800-THE-1553
Fax: 516-694-6715

INTERNATIONAL
Tel: 805-778-9229
Fax: 805-778-1980

NORTHEAST
Tel: 603-888-3975
Fax: 603-888-4585

SE AND MID-ATLANTIC
Tel: 321-951-4164
Fax: 321-951-4254

WEST COAST
Tel: 949-362-2260
Fax: 949-362-2266

CENTRAL
Tel: 719-594-8017
Fax: 719-594-8468

www.aeroflex.com info-ams@aeroflex.com



Aeroflex Microelectronic Solutions reserves the right to change at any time without notice the specifications, design, function, or form of its products described herein. All parameters must be validated for each customer's application by engineering. No liability is assumed as a result of use of this product. No patent licenses are implied.



Our passion for performance is defined by three attributes represented by these three icons: solution-minded, performance-driven and customer-focused