

TOSHIBA LED Lamp

TLRE17T,TLRME17T,TLSE17T TLOE17T,TLYE17T

Panel Circuit Indicator

- 5mm package
- InGaAlP technology
- All plastic mold type
- Transparent lens
- High intensity light emission
- Excellent low current light output
- Applications: Outdoor message signboards, safety equipment

Line-Up

Product Name	Color	Material
TLRE17T	Red	InGaAlP
TLRME17T	Red	InGaAlP
TLSE17T	Red	InGaAlP
TLOE17T	Orange	InGaAlP
TLYE17T	Yellow	InGaAlP

Unit in mm

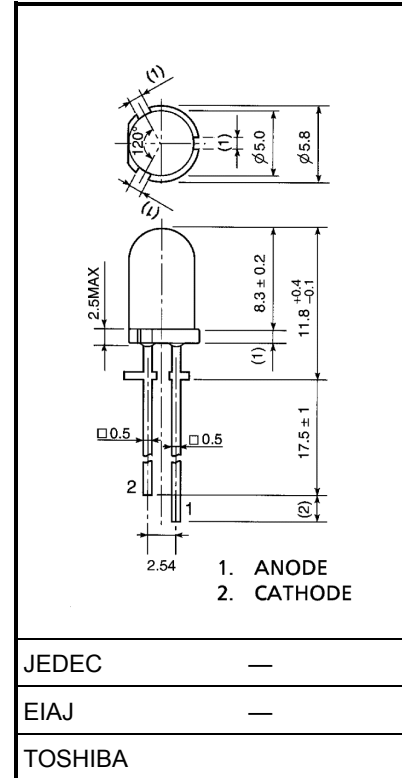

Weight: 0.31 g (typ.)

Maximum Ratings (Ta = 25°C)

Product Name	Forward Current I _F (mA)	Reverse Voltage V _R (V)	Power Dissipation P _D (mW)	Operating Temperature T _{opr} (°C)	Storage Temperature T _{stg} (°C)
TLRE17T	50	4	120	-40~100	-40~120
TLRME17T	50	4	120		
TLSE17T	50	4	120		
TLOE17T	50	4	120		
TLYE17T	50	4	120		

Electrical And Optical Characteristics (Ta = 25°C)

Product Name	Typ. Emission Wavelength				Luminous Intensity I _V			Forward Voltage V _F			Reverse Current I _R	
	λ _d	λ _p	Δλ	I _F	Min	Typ.	I _F	Typ.	Max	I _F	Max	V _R
TLRE17T	630	(644)	20	20	476	1500	20	1.9	2.4	20	50	4
TLRME17T	626	(636)	23	20	850	2400	20	1.9	2.4	20	50	4
TLSE17T	613	(623)	20	20	850	3000	20	1.9	2.4	20	50	4
TLOE17T	605	(612)	20	20	1530	4500	20	2.0	2.4	20	50	4
TLYE17T	587	(590)	17	20	850	3000	20	2.0	2.4	20	50	4
Unit	nm			mA	mcd		mA	V		mA	μA	V

Precautions

Please be careful of the following:

- Soldering temperature: 260°C max, soldering time: 3s max
(Soldering portion of lead: Below the lead stopper)
- If the lead is formed, the lead should be formed up to 5 mm from the body of the device without forming stress to the resin. Soldering should be performed after lead forming.
- This visible LED lamp also emits some IR light.

If a photodetector is located near the LED lamp, please ensure that it will not be affected by this IR light.

TLRE17T

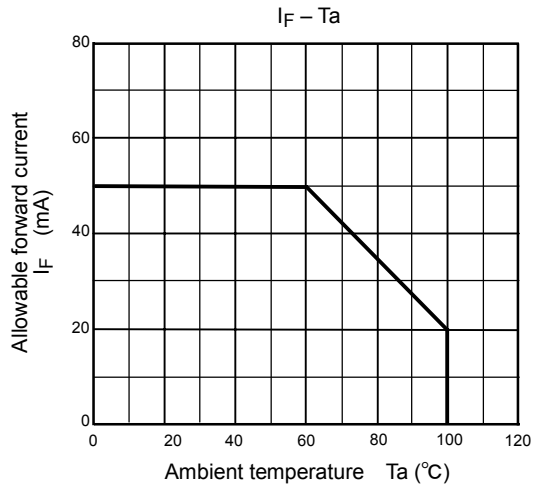
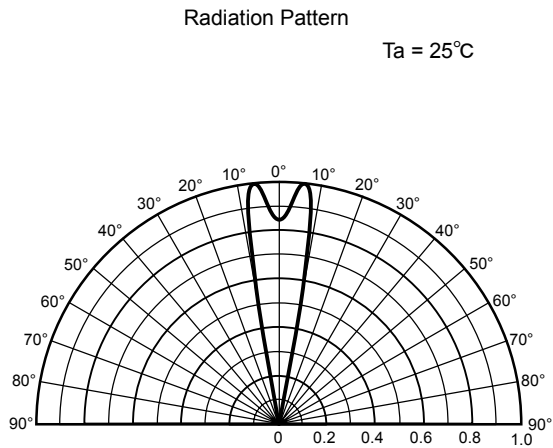
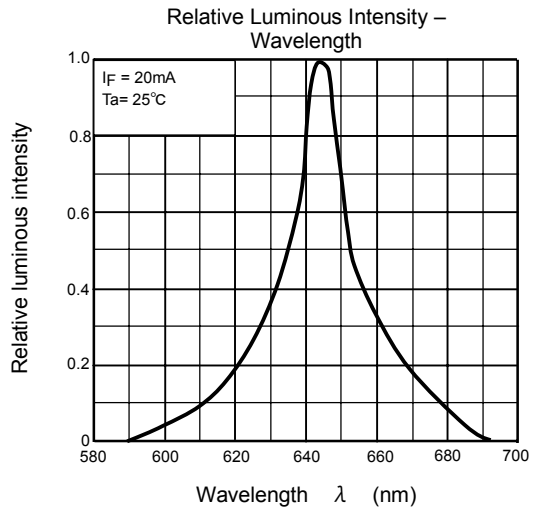
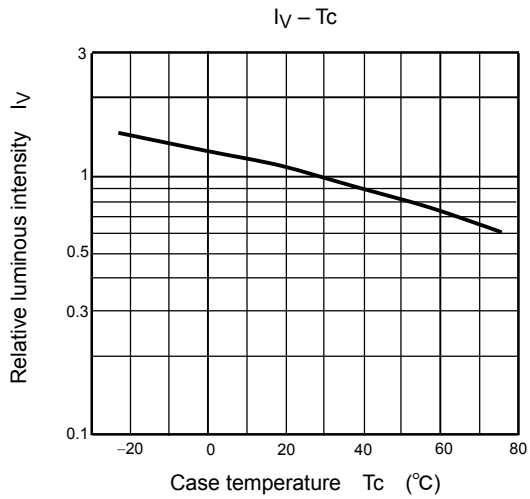
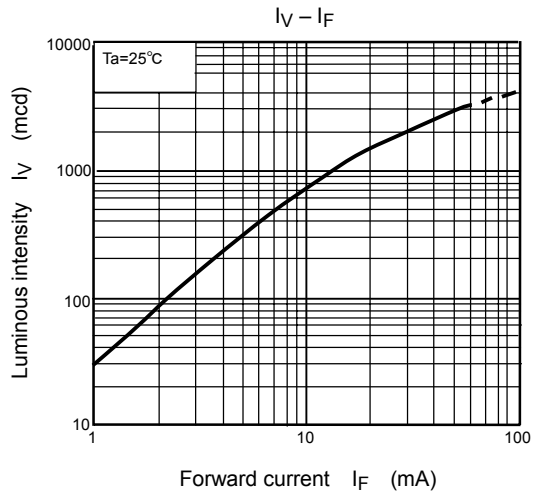
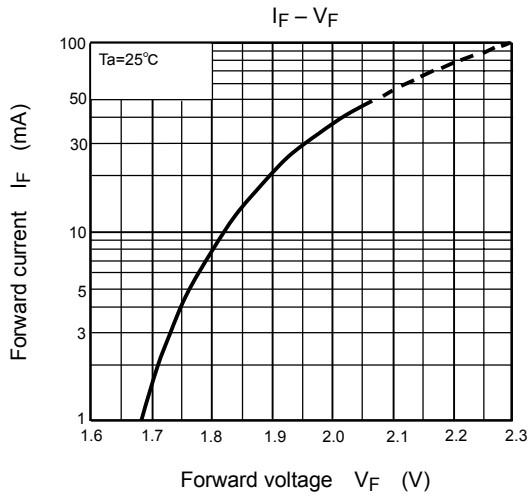

TLRME17T

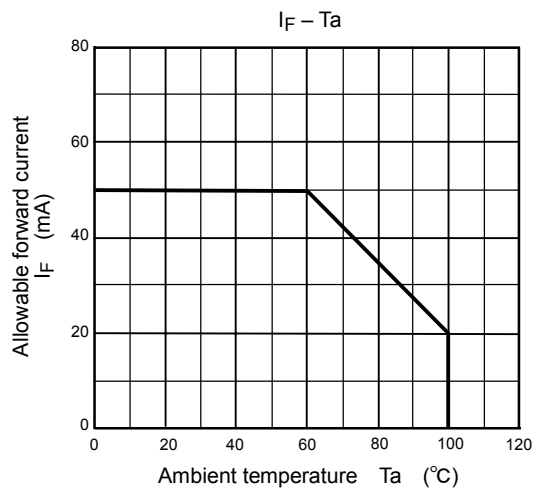
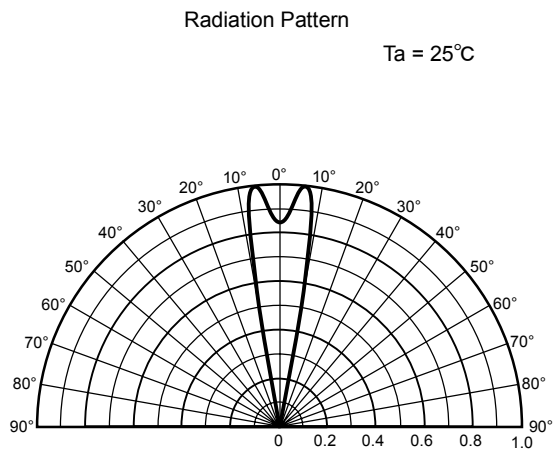
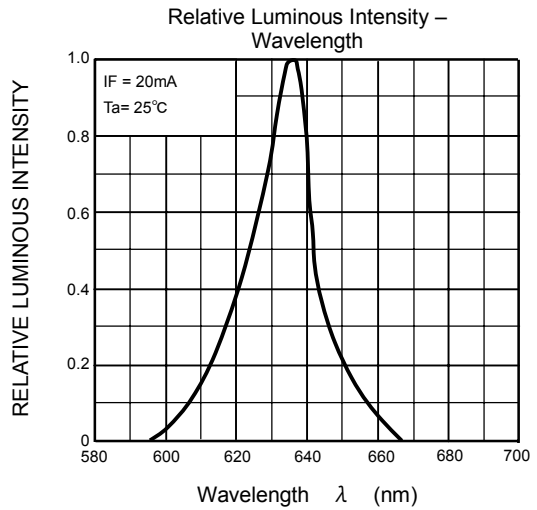
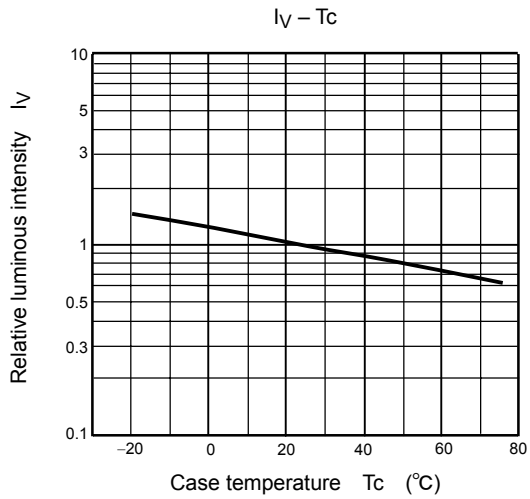
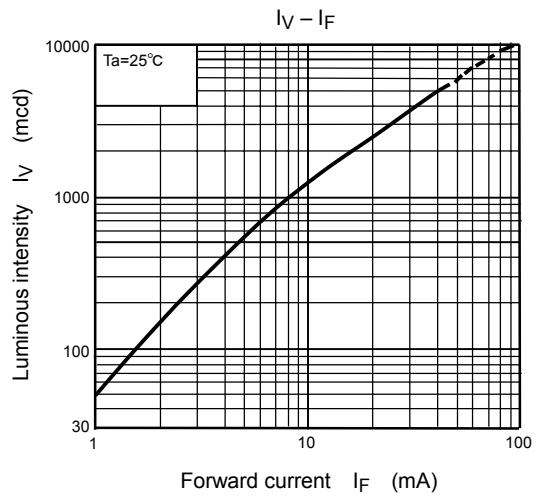
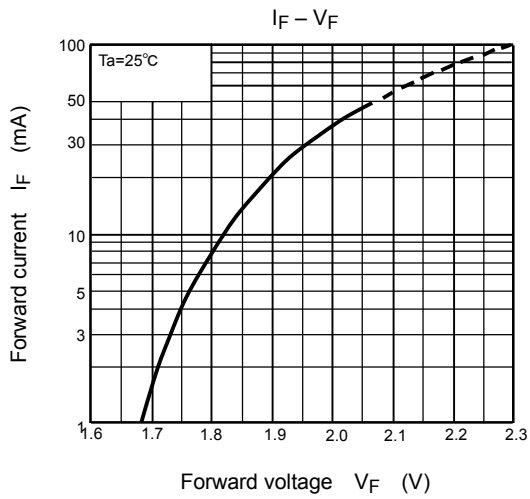

TLSE17T

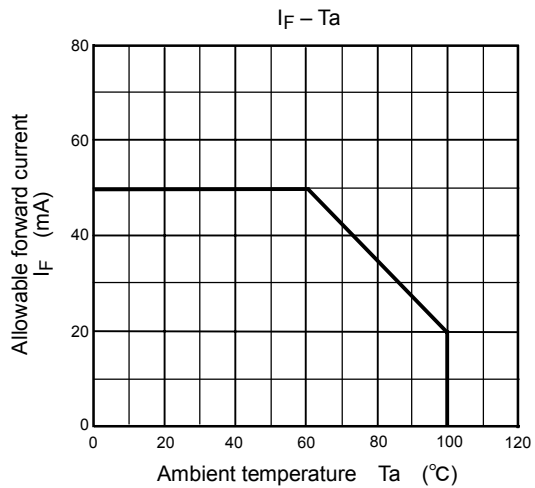
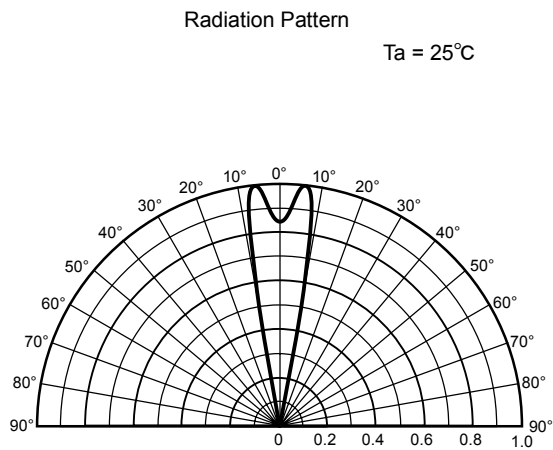
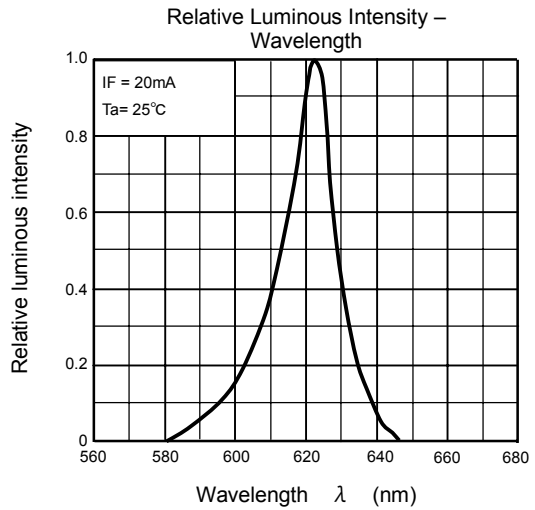
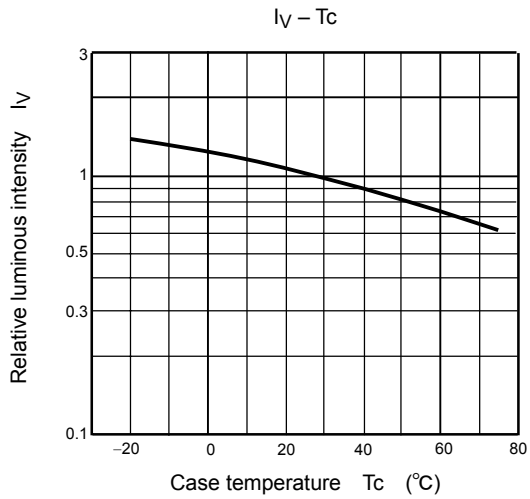
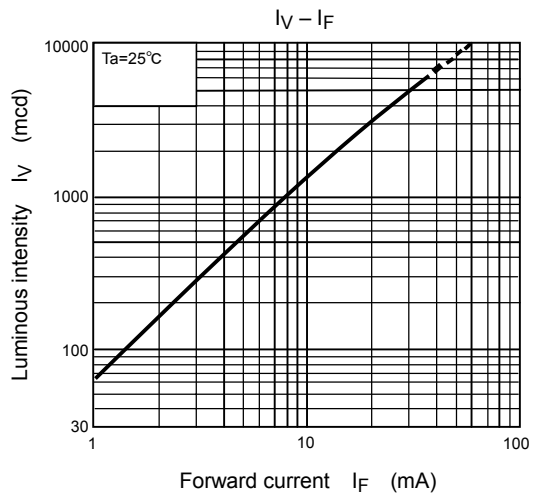
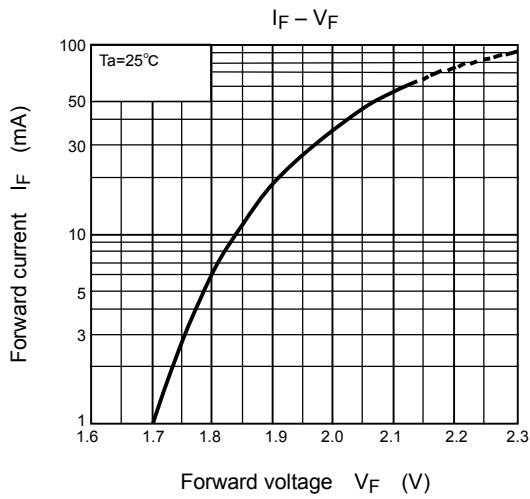

TLOE17T

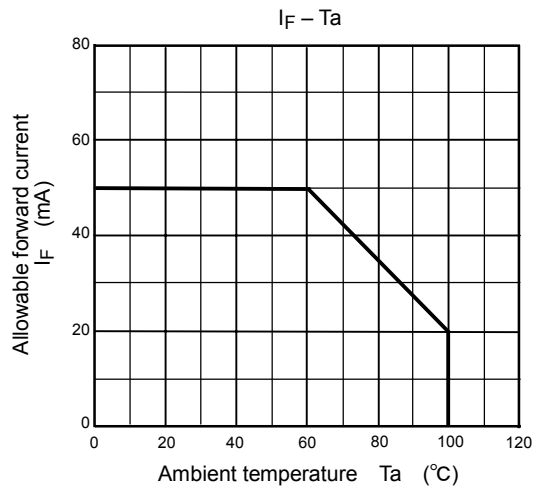
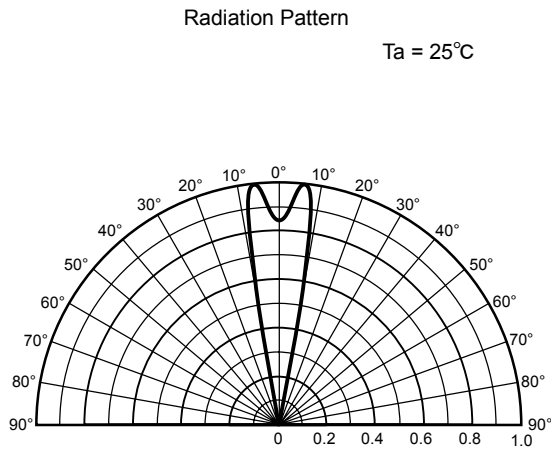
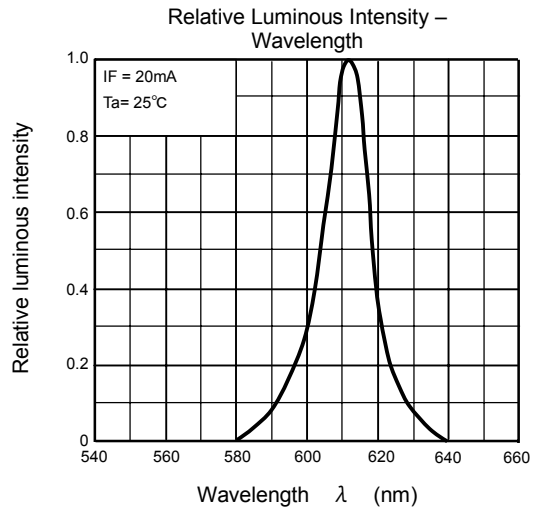
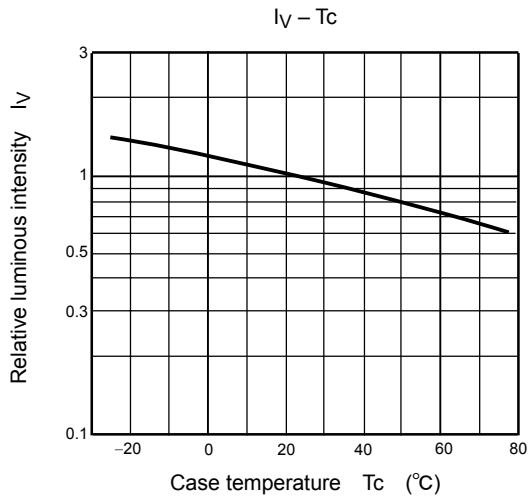
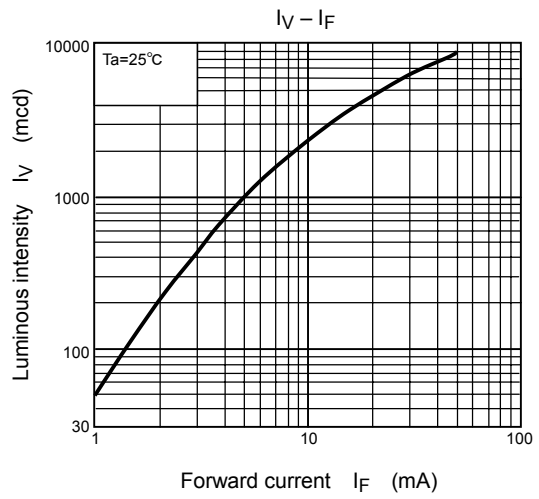
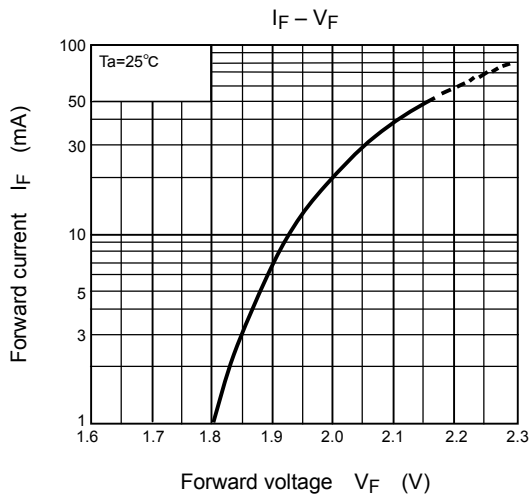

TLYE17T

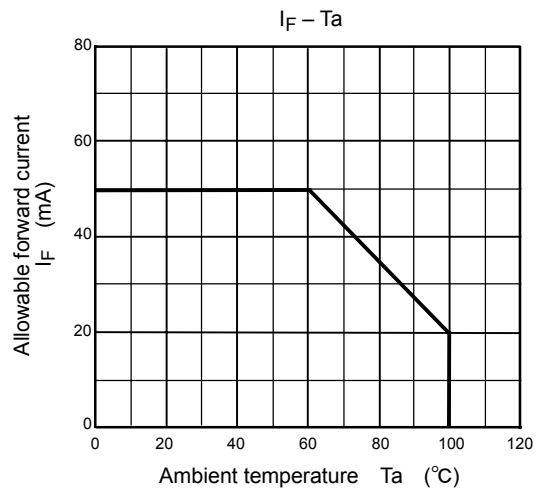
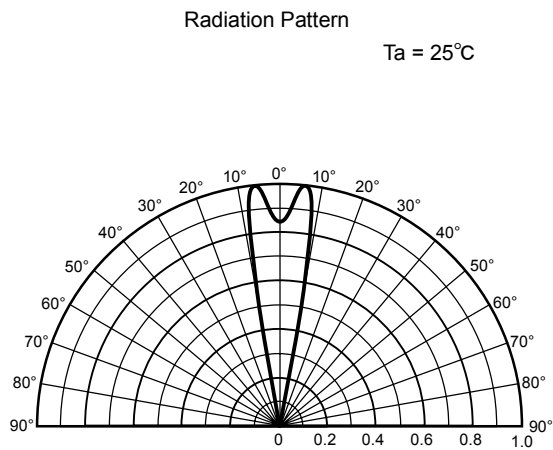
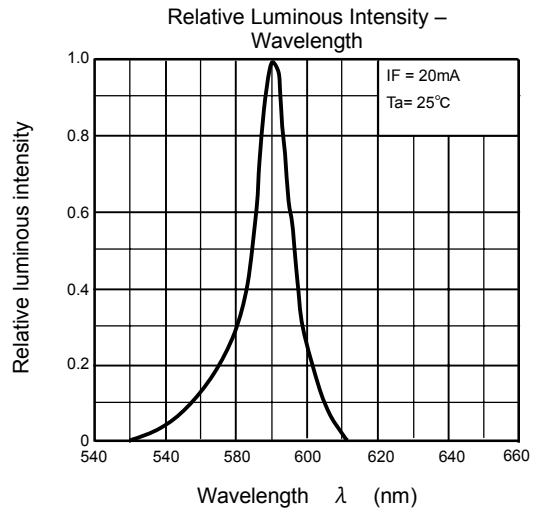
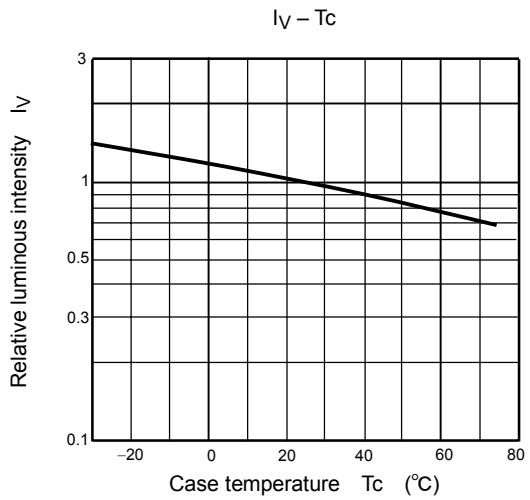
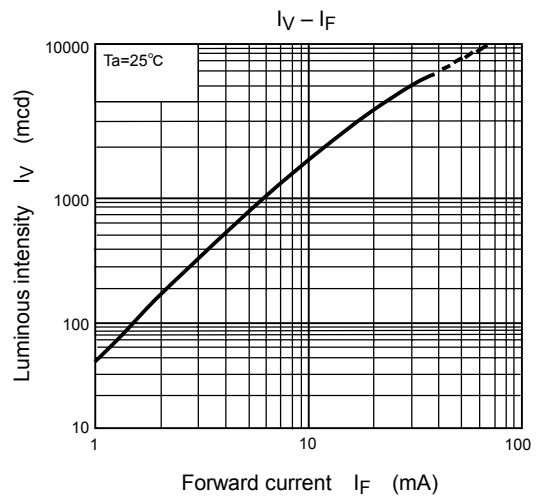
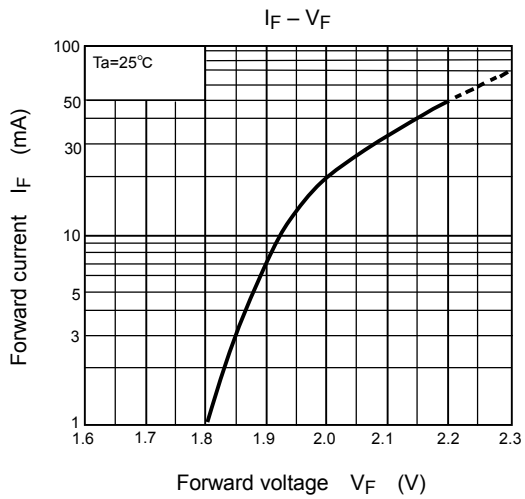

RESTRICTIONS ON PRODUCT USE

000707EAC

- TOSHIBA is continually working to improve the quality and reliability of its products. Nevertheless, semiconductor devices in general can malfunction or fail due to their inherent electrical sensitivity and vulnerability to physical stress. It is the responsibility of the buyer, when utilizing TOSHIBA products, to comply with the standards of safety in making a safe design for the entire system, and to avoid situations in which a malfunction or failure of such TOSHIBA products could cause loss of human life, bodily injury or damage to property.
In developing your designs, please ensure that TOSHIBA products are used within specified operating ranges as set forth in the most recent TOSHIBA products specifications. Also, please keep in mind the precautions and conditions set forth in the "Handling Guide for Semiconductor Devices," or "TOSHIBA Semiconductor Reliability Handbook" etc..
- The TOSHIBA products listed in this document are intended for usage in general electronics applications (computer, personal equipment, office equipment, measuring equipment, industrial robotics, domestic appliances, etc.). These TOSHIBA products are neither intended nor warranted for usage in equipment that requires extraordinarily high quality and/or reliability or a malfunction or failure of which may cause loss of human life or bodily injury ("Unintended Usage"). Unintended Usage include atomic energy control instruments, airplane or spaceship instruments, transportation instruments, traffic signal instruments, combustion control instruments, medical instruments, all types of safety devices, etc.. Unintended Usage of TOSHIBA products listed in this document shall be made at the customer's own risk.
- Gallium arsenide (GaAs) is a substance used in the products described in this document. GaAs dust and fumes are toxic. Do not break, cut or pulverize the product, or use chemicals to dissolve them. When disposing of the products, follow the appropriate regulations. Do not dispose of the products with other industrial waste or with domestic garbage.
- The information contained herein is presented only as a guide for the applications of our products. No responsibility is assumed by TOSHIBA CORPORATION for any infringements of intellectual property or other rights of the third parties which may result from its use. No license is granted by implication or otherwise under any intellectual property or other rights of TOSHIBA CORPORATION or others.
- The information contained herein is subject to change without notice.