

DVP-C600D

RMT-D104A

SERVICE MANUAL

Self Diagnostics
Supported model

*US Model
Canadian Model
Mexican Model*



SPECIFICATIONS

CD/DVD player

Laser Semiconductor laser
Signal format system NTSC

Audio characteristics

Frequency response DVD (PCM 96 kHz): 2 Hz to 44 kHz (±0.5 dB)*
DVD (PCM 48 kHz): 2 Hz to 22 kHz (±0.5 dB)
CD: 2 Hz to 20 kHz (±0.5 dB)
Signal-to-noise ratio More than 115 dB (LINE OUT (AUDIO 1, 2) connectors only)
Harmonic distortion Less than 0.0028%
Dynamic range More than 100 dB (DVD)
More than 97 dB (CD)
Wow and flutter Less than detected value (±0.001% W PEAK)

Outputs and inputs

	Jack type	Output/Input level	Load impedance
LINE OUT (AUDIO 1, 2)	Phono jacks	2 Vrms (at 50 kilohms)	Over 10 kilohms
DIGITAL OUT (OPTICAL)	Optical output connector	-18 dBm	Wave length: 660 nm
DIGITAL OUT (COAXIAL)	Phono jack	0.5 Vp-p	75 ohms terminated
LINE OUT (VIDEO 1, 2)	Phono jacks	1.0 Vp-p	75 ohms, sync negative
5 VIDEO OUT (1, 2)	4-pin mini DIN	Y: 1.0 Vp-p C: 0.286 Vp-p	75 ohms, sync negative 75 ohms terminated
COMPONENT VIDEO OUT (Y, Cb/B-Y, Cr/R-Y)	Phono jacks	Y: 1.0 Vp-p Cb/B-Y, Cr/R-Y: 0.7 Vp-p	75 ohms, sync negative 75 ohms
PHONES	Phone jack	12 mW	32 ohms
S-LINK	Mini jack		
5.1CH OUTPUT	Phono jacks	1.6 Vrms (at 50 kilohms)	Over 10 kilohms
MEGA CONTROL	Mini jack		
AUDIO IN	Phono jack	2 Vrms	47 kilohms

General

Power requirements 120 V AC, 60 Hz
Power consumption 22 W
Dimensions (approx.) 430 × 120 × 425 mm (17 × 4 3/4 × 16 3/4 in.) (w/h/d) incl. projecting parts
Mass (approx.) 6.1 kg (13 lb 7 oz)
Operating temperature 41 °F to 95 °F (5 °C to 35 °C)
Operating humidity 5% to 90%

Supplied accessories

- Audio/video/S-link connecting cord (1)
- S video cable (1)
- Remote commander (remote) RMT-D104A (1)
- Size AA (R6) batteries (2)

* The signals from LINE OUT (AUDIO 1, 2) connectors are measured. When you play the PCM sound tracks with 96 kHz sampling frequency, the output signals from the DIGITAL OUT (OPTICAL, COAXIAL) and 5.1CH OUTPUT connectors are converted to 48 kHz (sampling frequency)/16 bits (quantization bits).

Design and specifications are subject to change without notice.



CD/DVD PLAYER

SONY®

• Waveforms

1 IC006 ⑤1 - ⑤2 (DVD play)

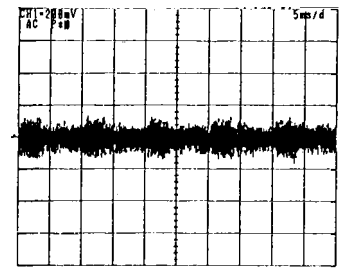

270 mVp-p (V)

2 IC006 ⑥1 - ⑥2 (DVD play)

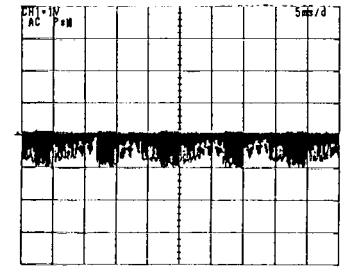

1.2 Vp-p (V)

3 IC006 ⑥3 - ⑥4 (DVD play)

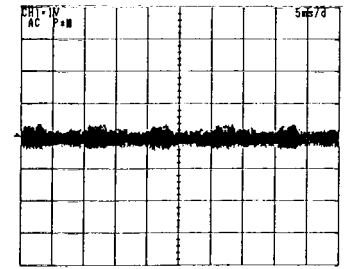

800 mVp-p (V)

4 IC005 ⑬ (CD play)

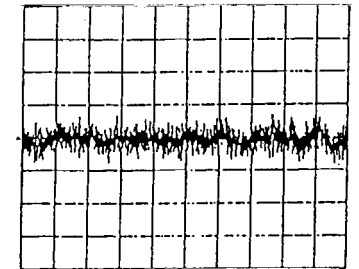

500 mV/DIV 1 ms/DIV

5 IC005 ⑮ (CD play)

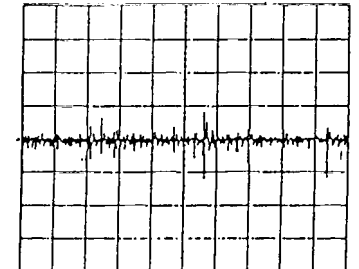

500 mV/DIV 10 ms/DIV

6 IC005 ⑳ (CD play)

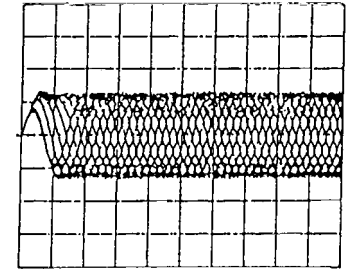

500 mV/DIV 1 μs/DIV

Note:
The components identified by mark Δ or dotted line with mark Δ are critical for safety.
Replace only with part number specified.

Note:
Les composants identifiés par une marque Δ sont critiques pour la sécurité.
Ne les remplacer que par une pièce portant le numéro spécifié.

TK-48 (RF, SERVO 1) SCHEMATIC DIAGRAM
- Ref. No.: TK-48 board; 3,000 series -

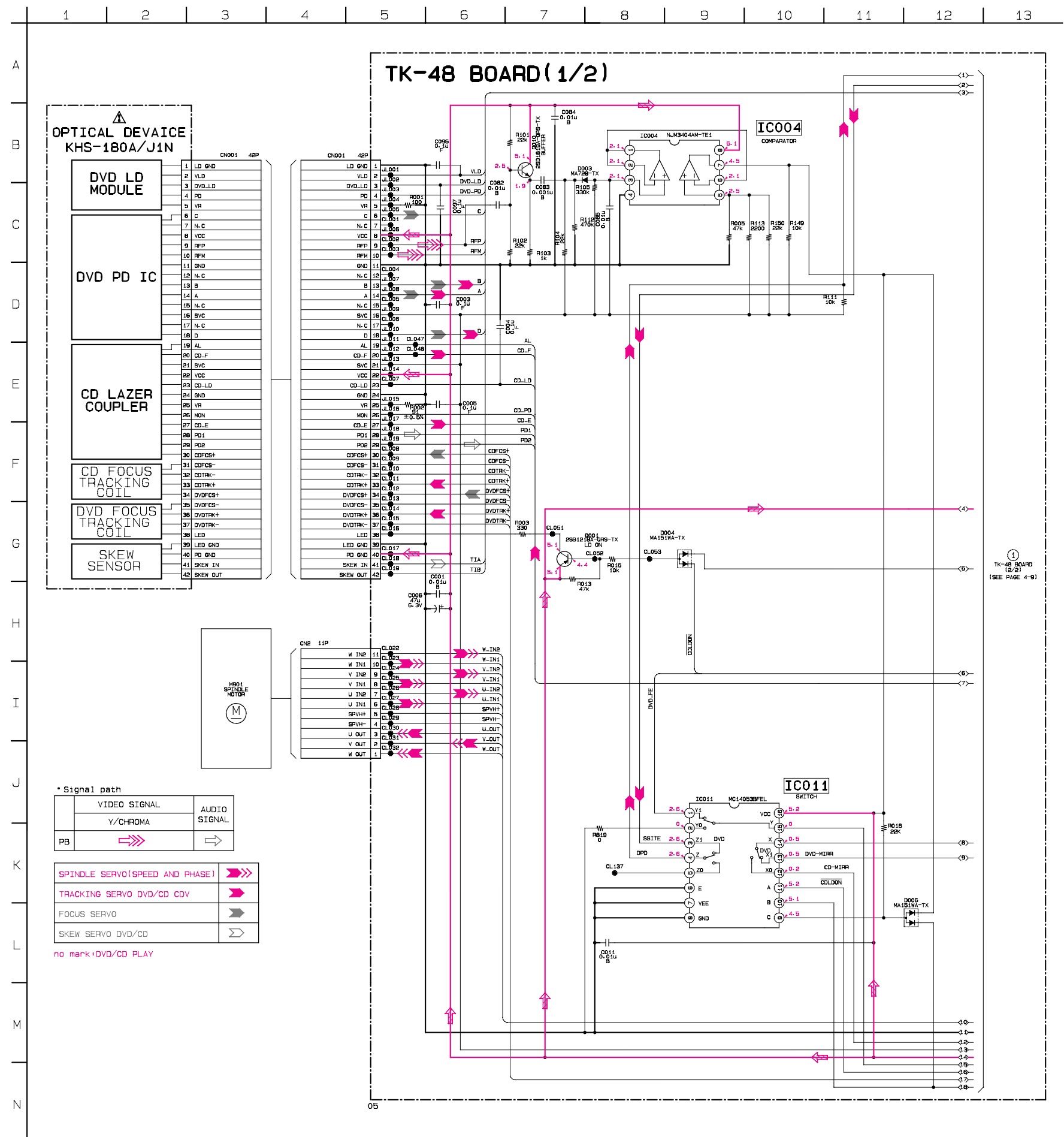

TK-48 (RF, SERVO 2) SCHEMATIC DIAGRAM

- Ref. No.: TK-48 board; 3,000 series -

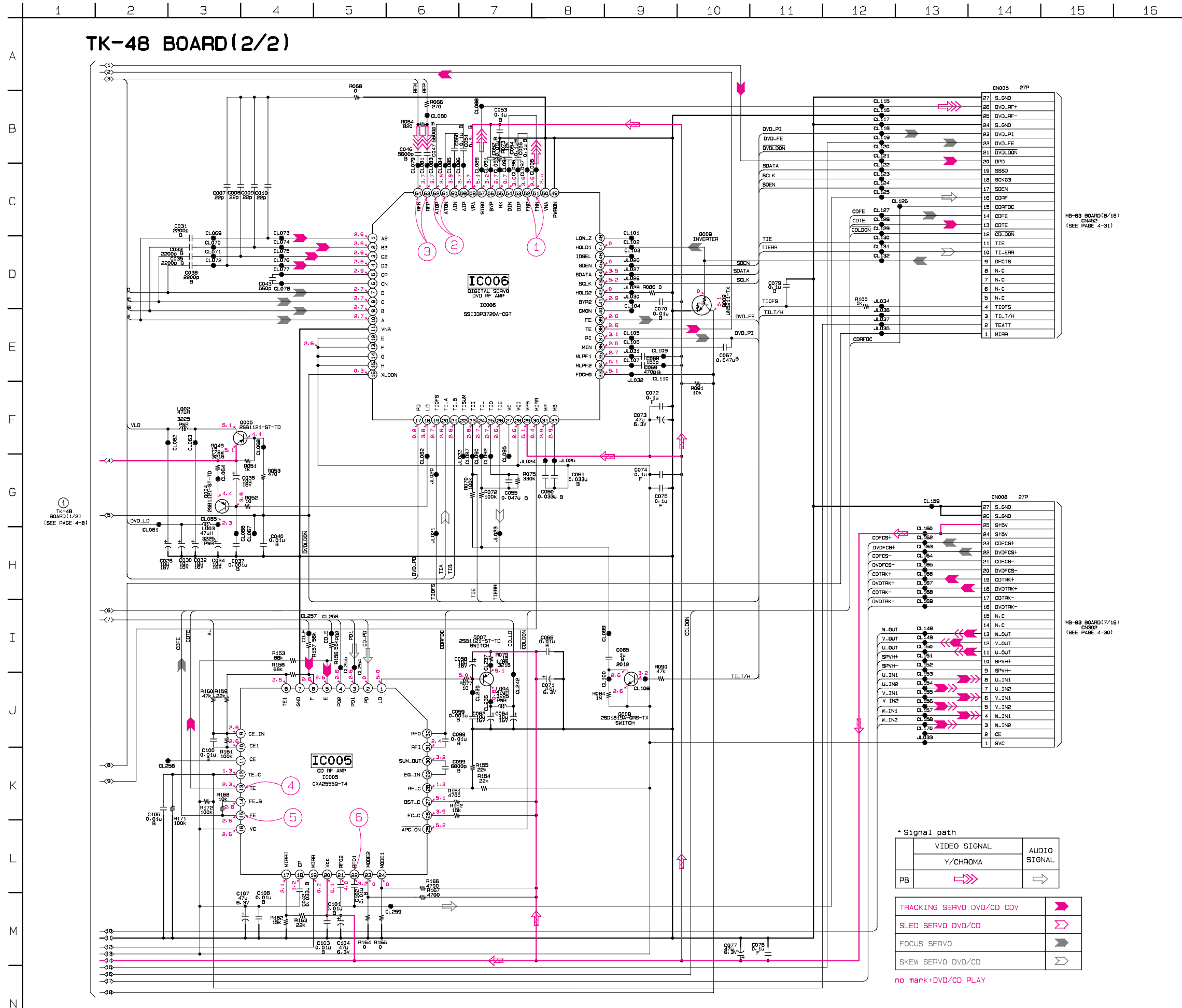

TK-48 BOARD (1/2) (SEE PAGE 4-8)

MB-83 BOARD (8/16) CVA89 (SEE PAGE 4-31)

MB-83 BOARD (7/16) CVA89 (SEE PAGE 4-30)

MB-83 (AC-3 DECODER) SCHEMATIC DIAGRAM • See page 4-11 to 4-14 for printed wiring board.

– Ref. No.: MB-83 board; 2,000 series –

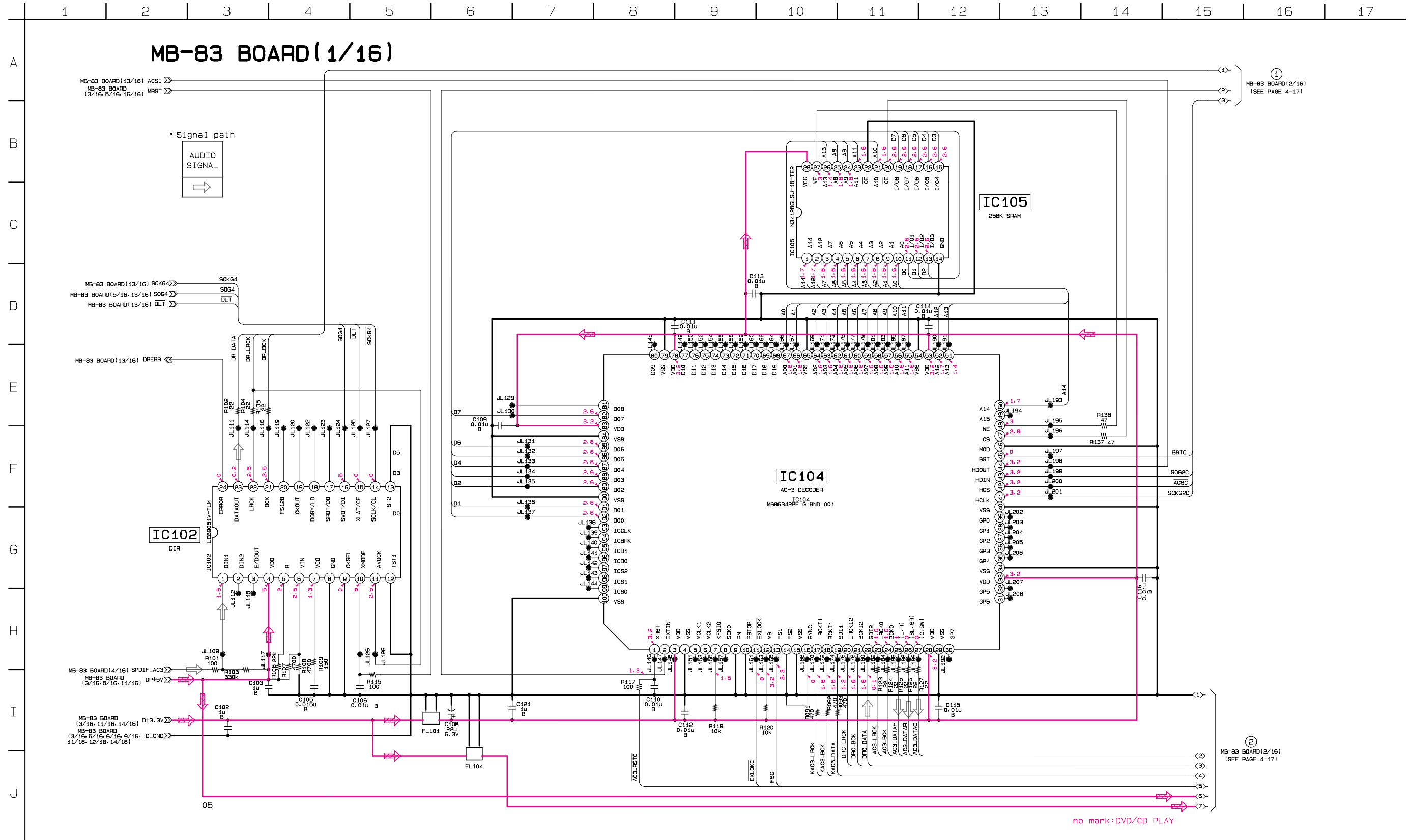

MB-83 (M GATE ARRAY) SCHEMATIC DIAGRAM • See page 4-11 to 4-14 for printed wiring board.
- Ref. No.: MB-83 board; 2,000 series -

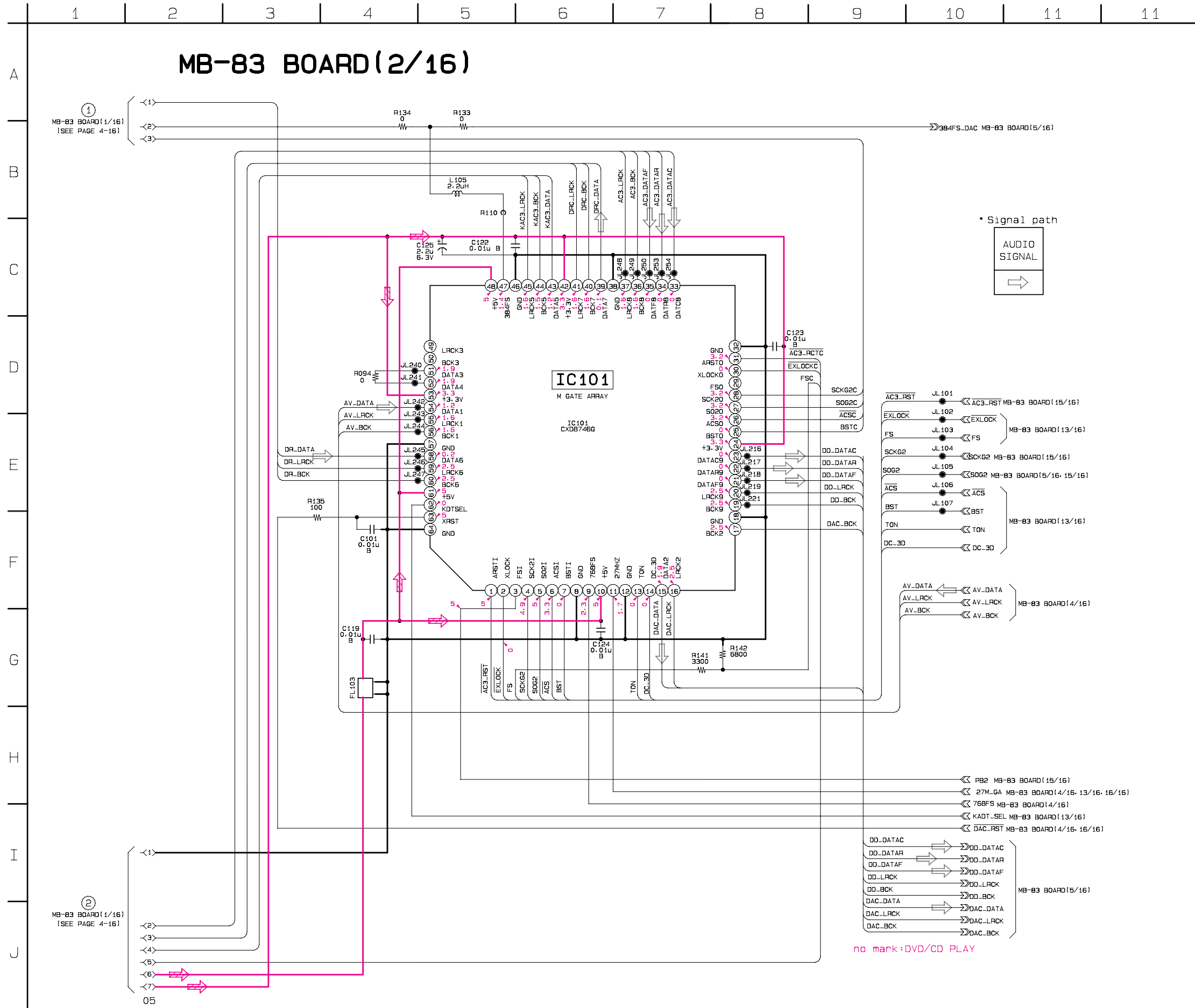

MB-83 (CLOCK GENERATOR) SCHEMATIC DIAGRAM • See page 4-11 to 4-14 for printed wiring board.

- Ref. No.: MB-83 board; 2,000 series -

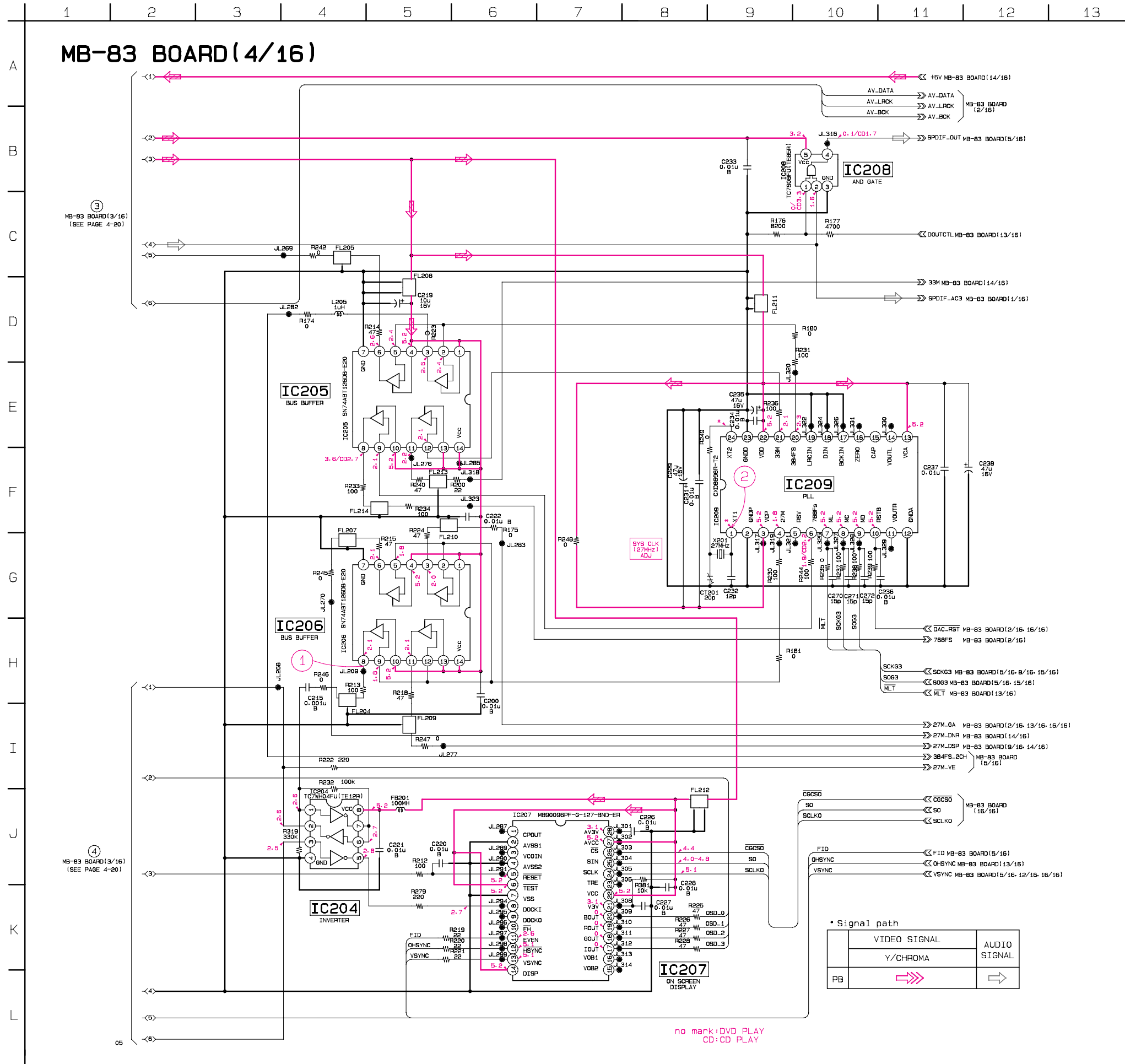

• Waveforms

1 IC206 ⑧

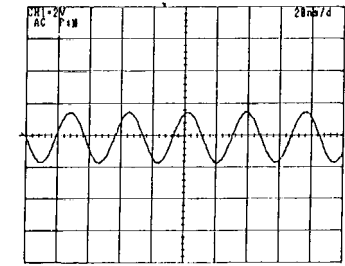

3.28 Vp-p 27 MHz

2 IC209 ①

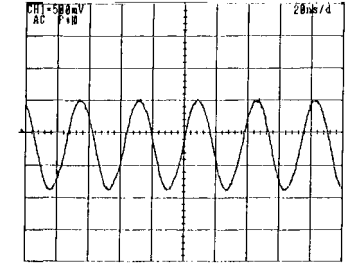

1.4 Vp-p 27 MHz

MB-83 (VIDEO ENCODER) SCHEMATIC DIAGRAM • See page 4-11 to 4-14 for printed wiring board.

– Ref. No.: MB-83 board; 2,000 series –

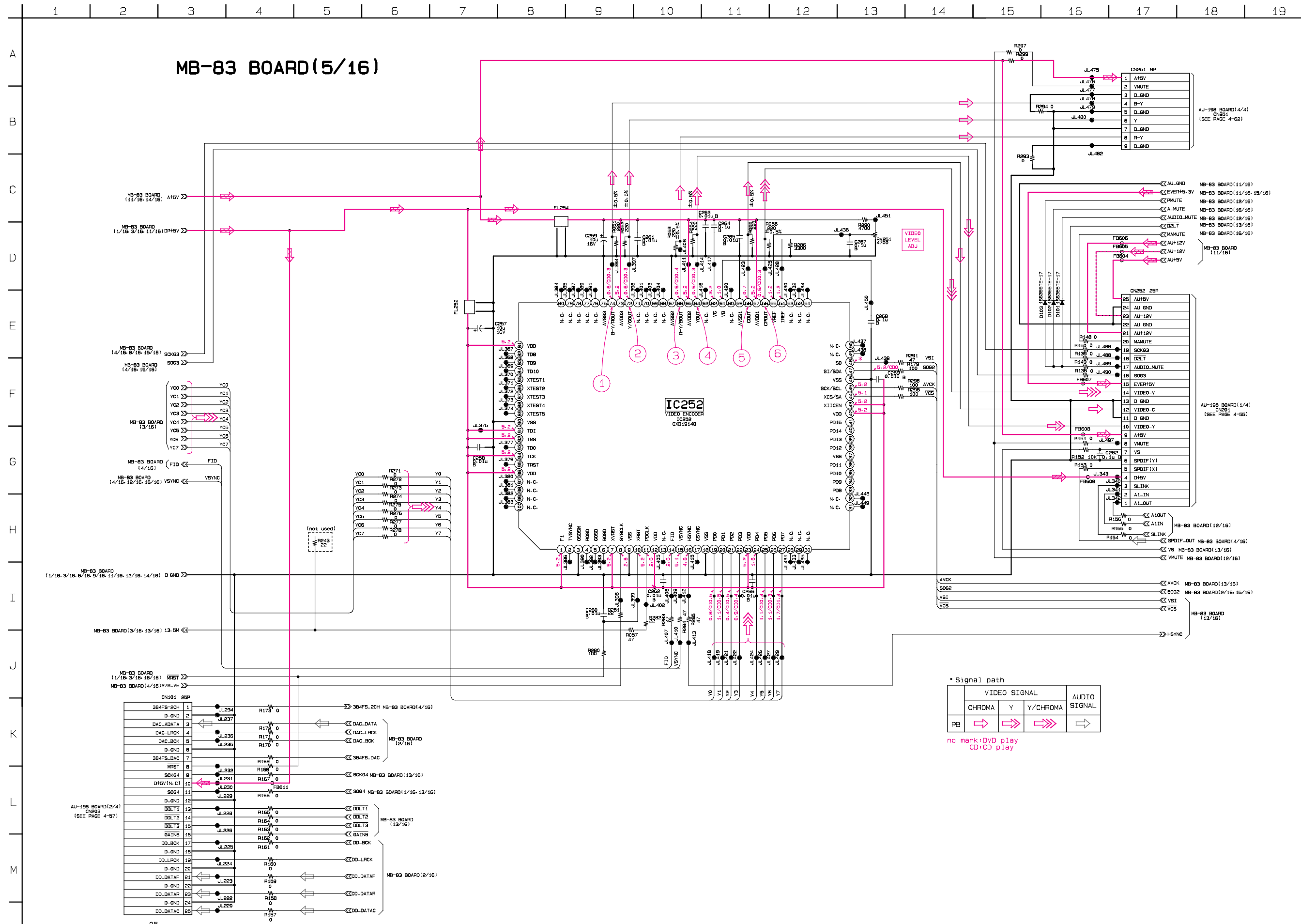

MB-83 (DRIVE 1) SCHEMATIC DIAGRAM • See page 4-11 to 4-14 for printed wiring board.
 – Ref. No.: MB-83 board; 2,000 series –

• Waveforms

① IC303 (19, 22, 23) (DVD play)

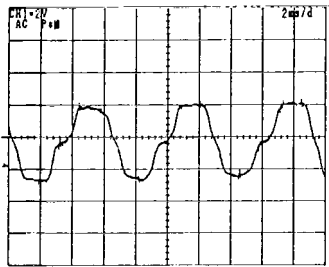

5.2 Vp-p 160 Hz

② IC303 (19, 22, 23) (CD play)

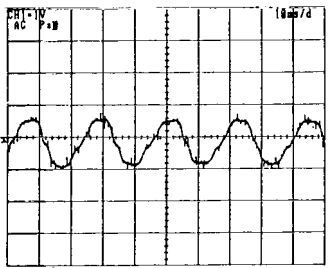

1.84 Vp-p 45 Hz

Note:
 The components identified by mark Δ or dotted line with mark Δ are critical for safety. Replace only with part number specified.

Note:
 Les composants identifiés par une marque Δ sont critiques pour la sécurité. Ne les remplacer que par une pièce portant le numéro spécifié.

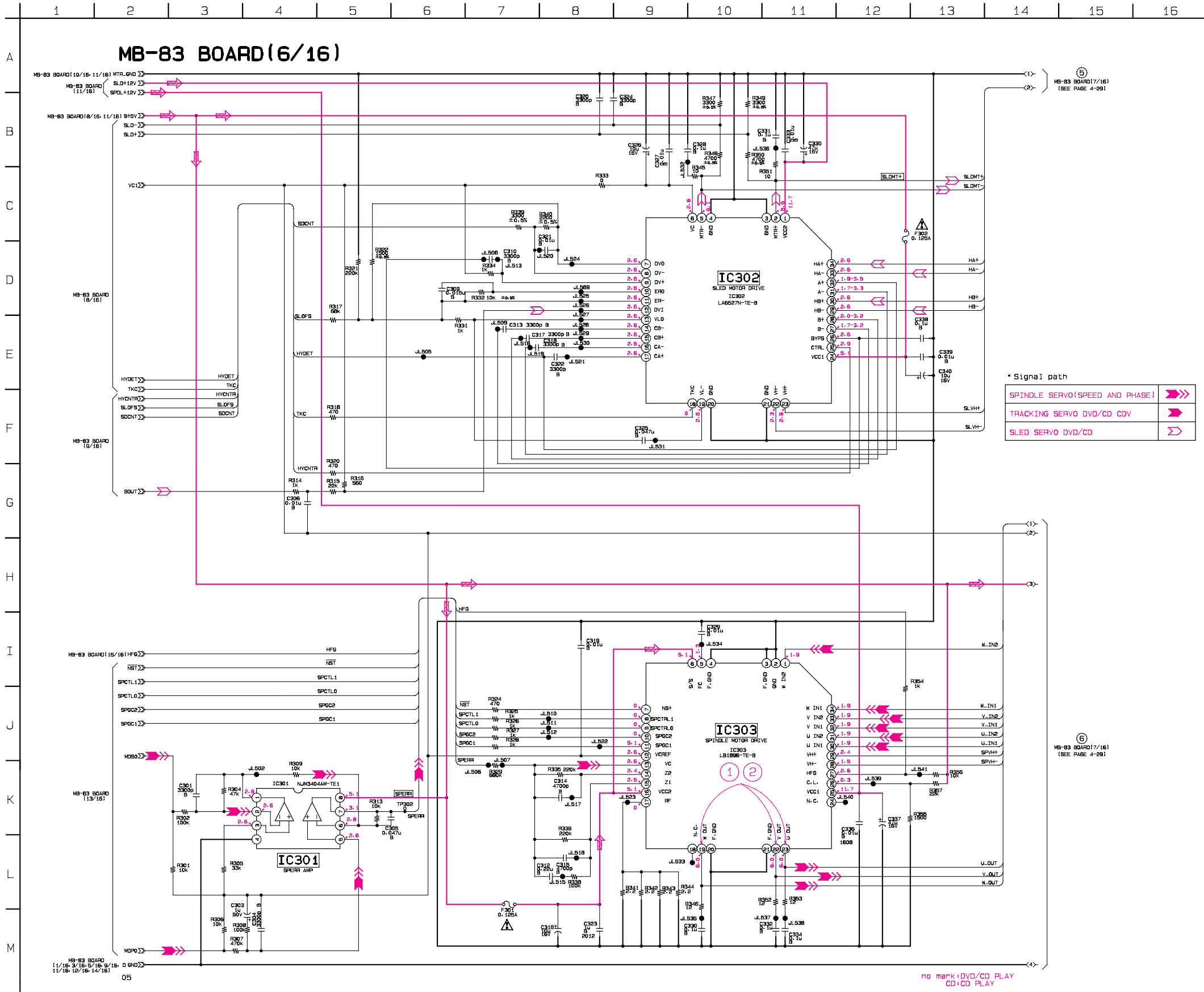

MB-83 (DRIVE 2), FG-44 (SLED) SCHEMATIC DIAGRAMS • See page 4-11 to 4-14 and 4-26 for printed wiring boards.

– Ref. No.: MB-83 board; 2,000 series, FG-44 board; 1,000 series –

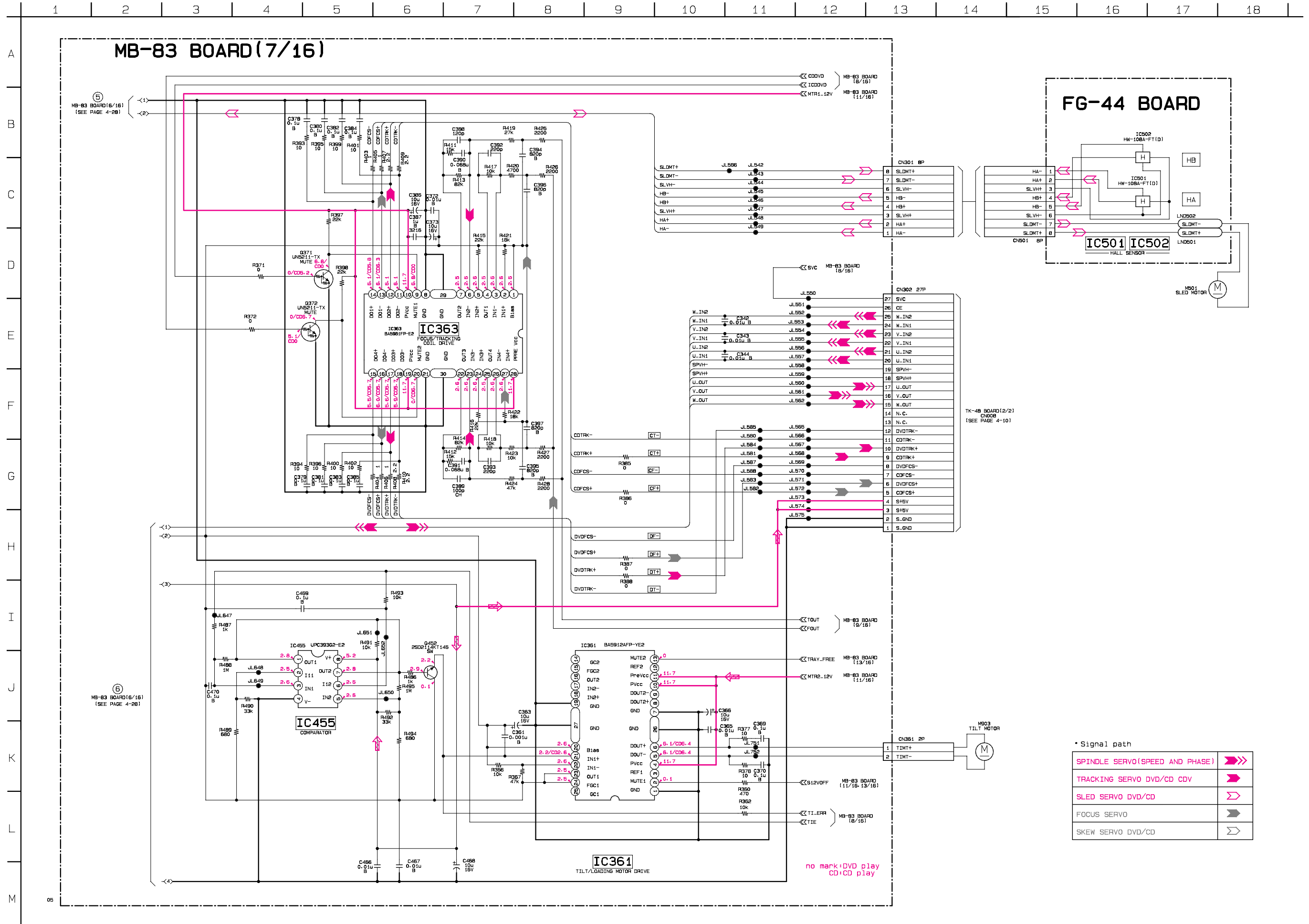

MB-83 (DSP 1) SCHEMATIC DIAGRAM • See page 4-11 to 4-14 for printed wiring board.

- Ref. No.: MB-83 board; 2,000 series -

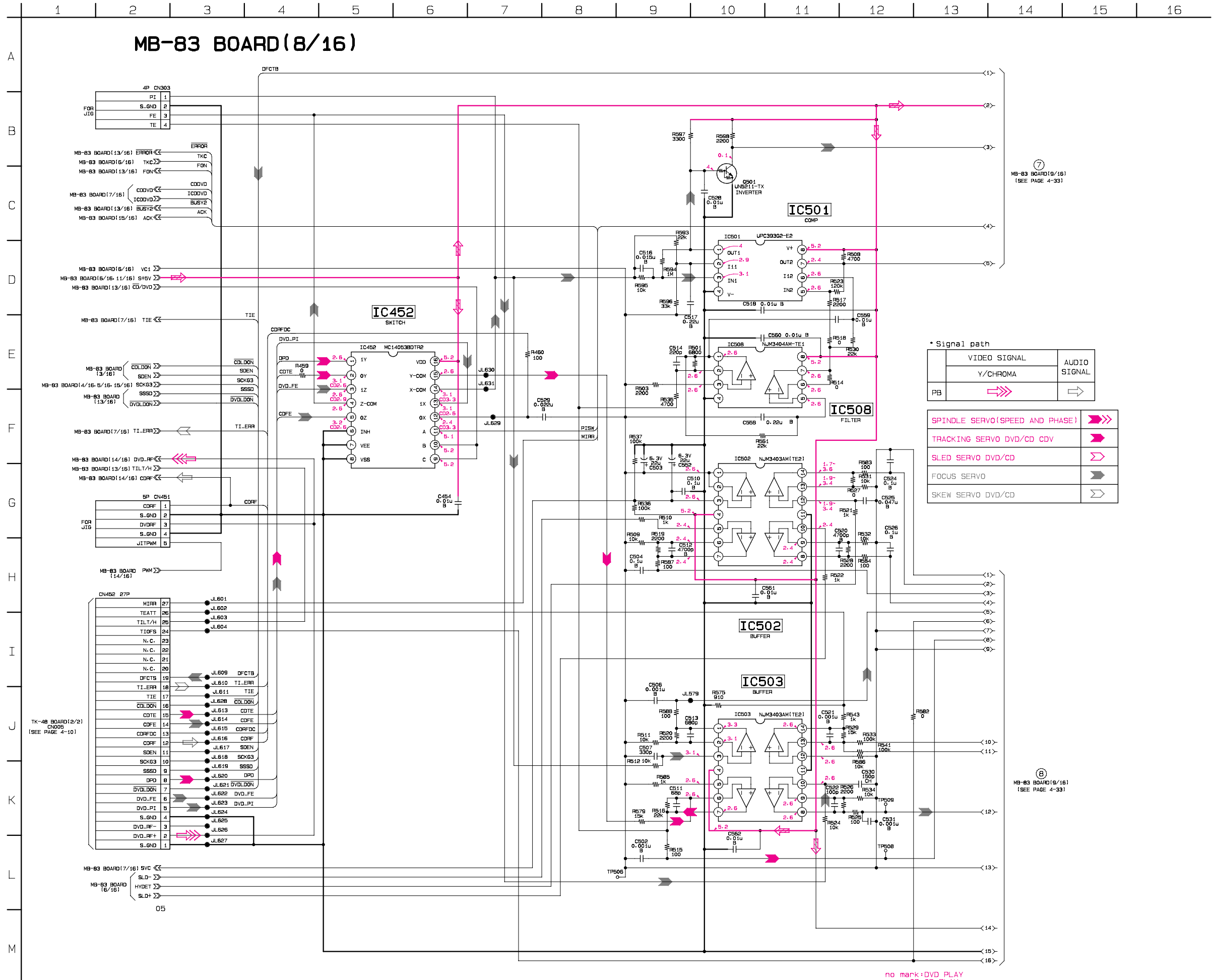

no mark: DVD PLAY
CD: CD PLAY

MB-83 (DSP 2) SCHEMATIC DIAGRAM • See page 4-11 to 4-14 for printed wiring board.

– Ref. No.: MB-83 board; 2,000 series –

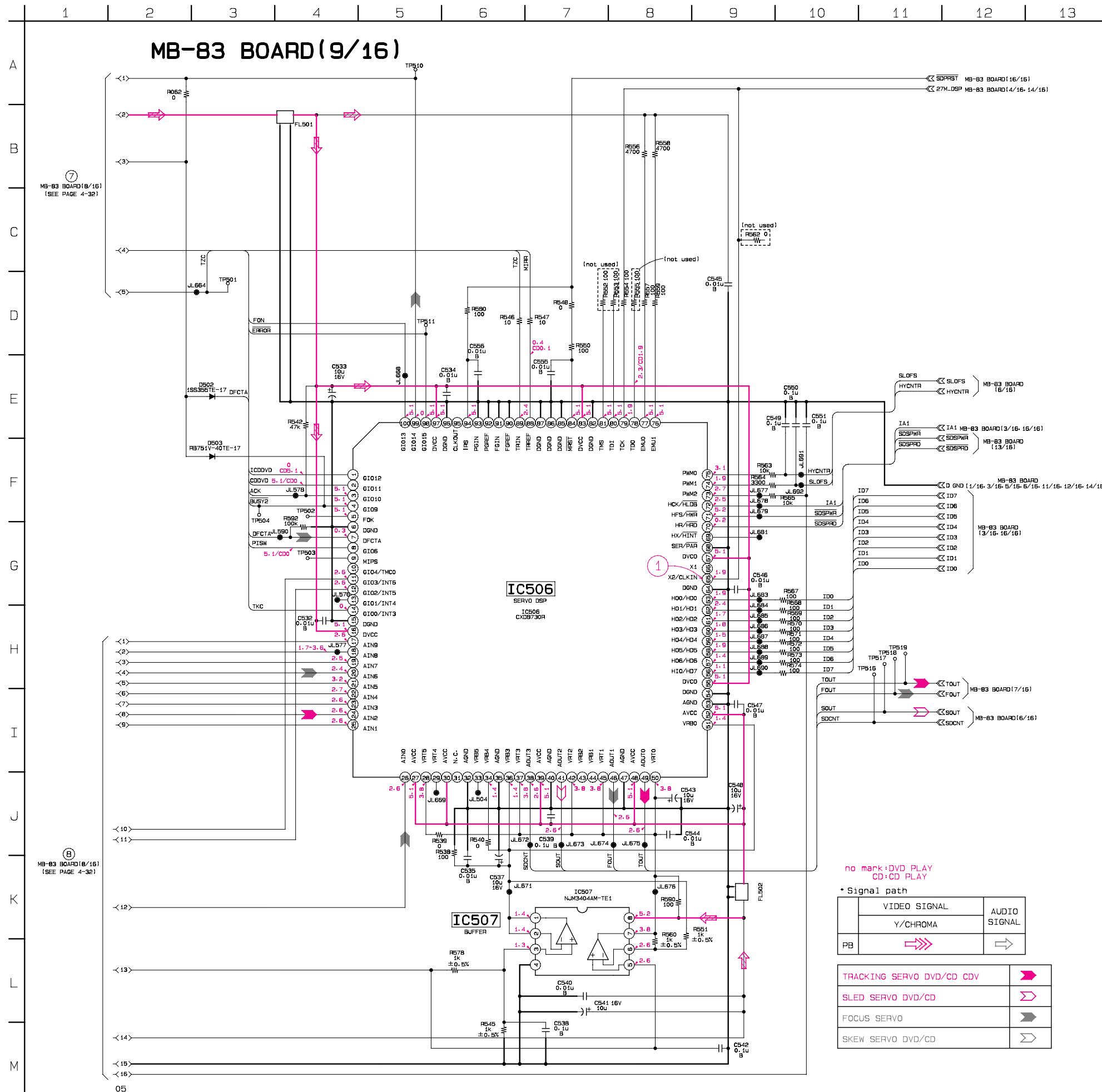

• Waveform

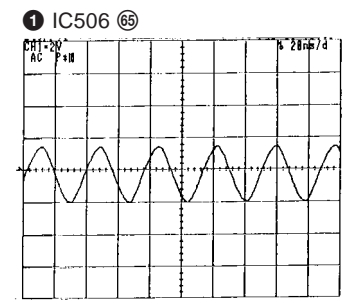

3.6 Vp-p 27 MHz

no mark: DVD PLAY
CD: CD PLAY

• Signal path

VIDEO SIGNAL	AUDIO SIGNAL
Y/CHROMA	
PB	

TRACKING SERVO DVD/CD CDV	➔
SLID SERVO DVD/CD	➤
FOCUS SERVO	➡
SKEW SERVO DVD/CD	➤

MB-83 (ROULETTE), CK-78 (CONNECTION), LM-55 (LOADING MOTOR), SE-70 (SENSOR) SCHEMATIC DIAGRAM • See page 4-11 to 4-14 for printed wiring board.

– Ref. No.: MB-83 board; 2,000 series, CK-78, LM-55, SE-70 boards; 1,000 series –

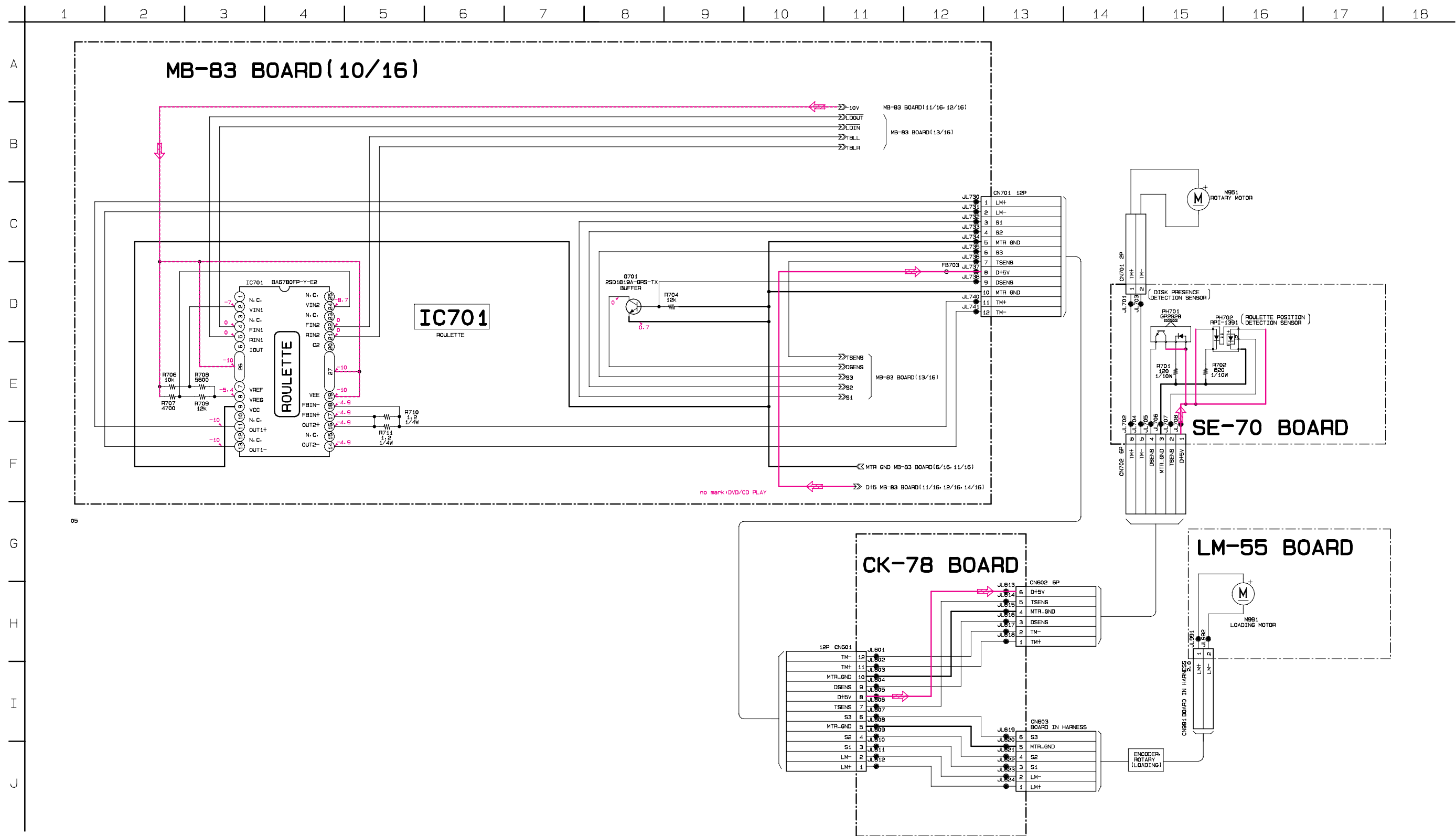

MB-83 (BIAS) SCHEMATIC DIAGRAM • See page 4-11 to 4-14 for printed wiring board.

– Ref. No.: MB-83 boards; 2,000 series –

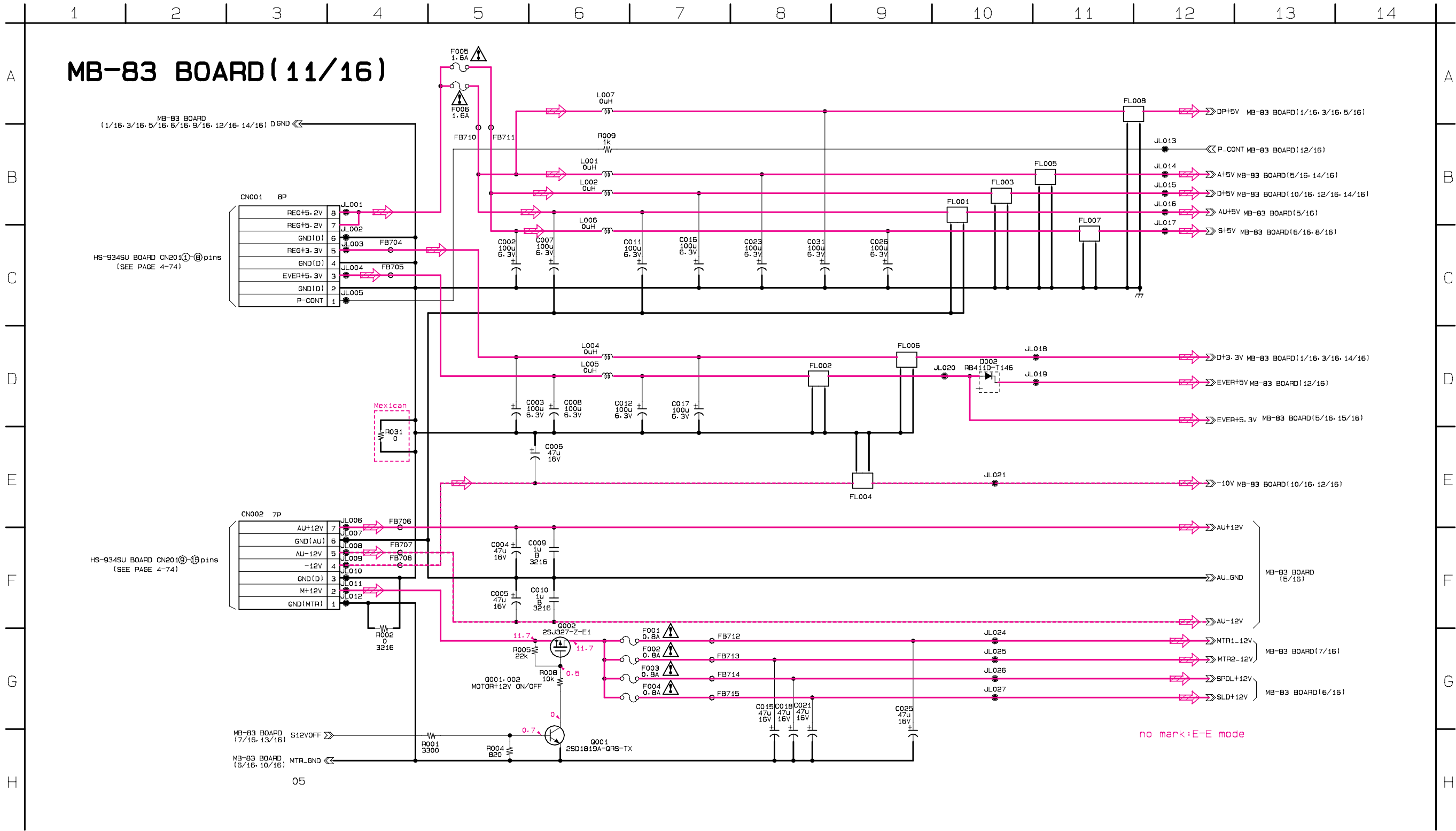

Note:
The components identified by mark \triangle or dotted line with mark \triangle are critical for safety. Replace only with part number specified.

Note:
Les composants identifiés par une marque \triangle sont critiques pour la sécurité. Ne les remplacer que par une pièce portant le numéro spécifié.

MB-83 (IF μ-COM) SCHEMATIC DIAGRAM • See page 4-11 to 4-14 for printed wiring board.

- Ref. No.: MB-83 board; 2,000 series -

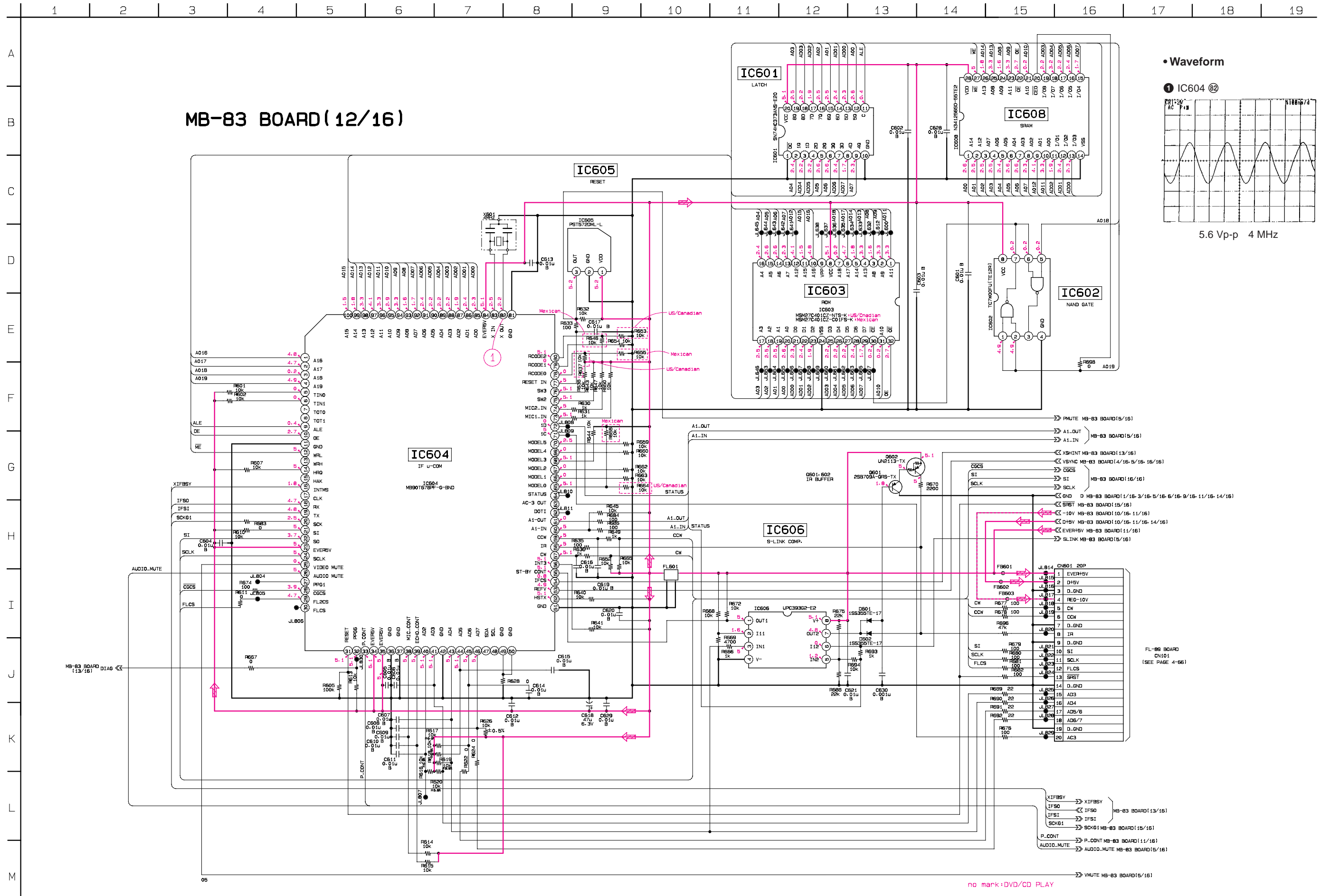

• Waveforms

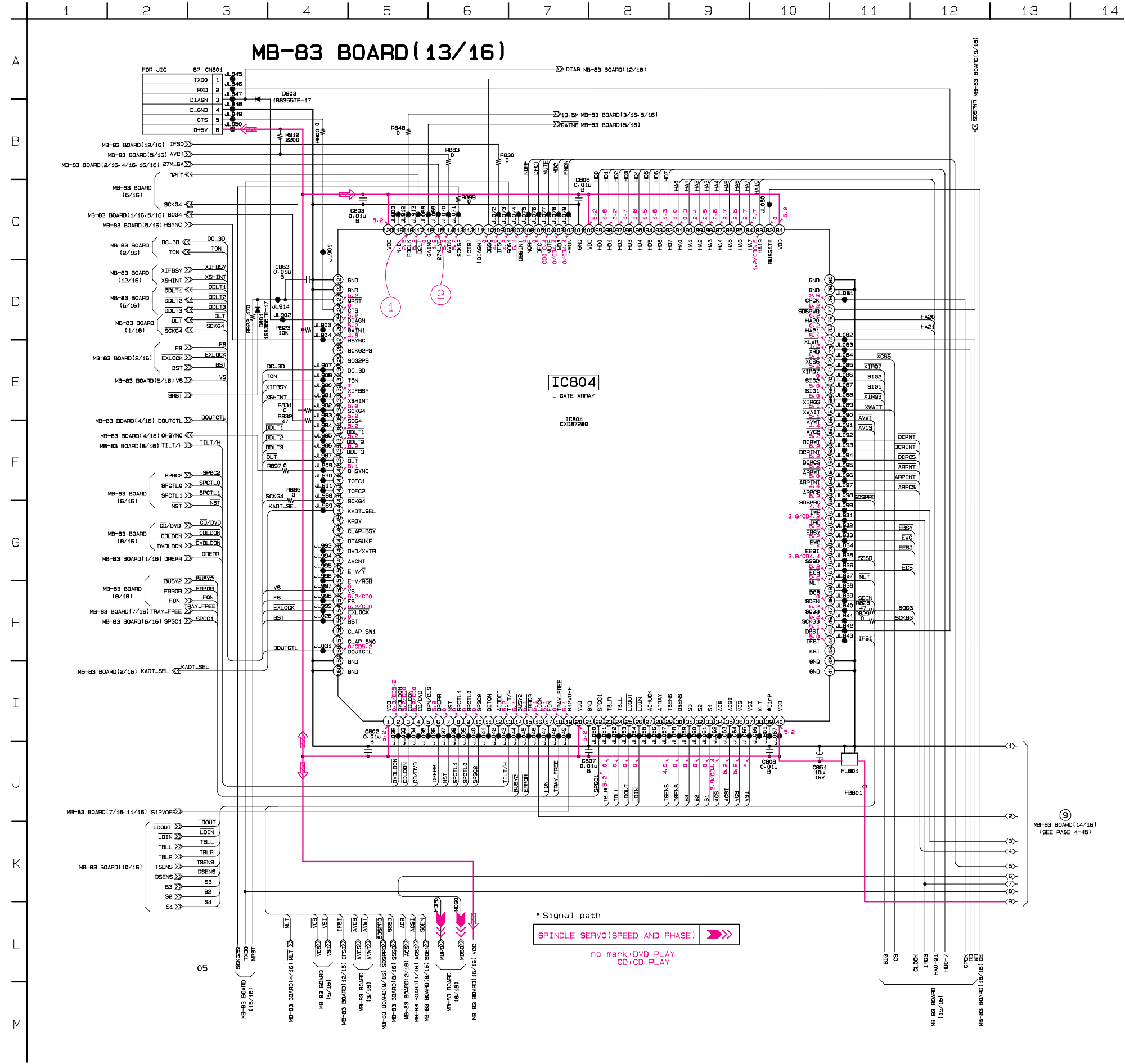
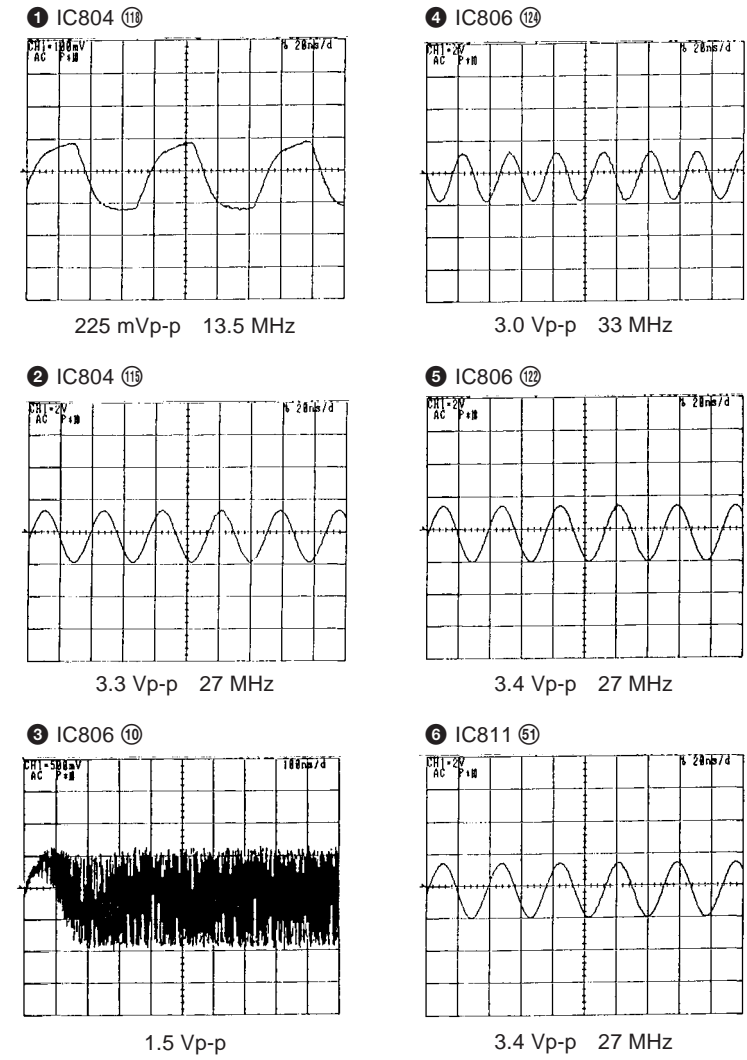

MB-83 (SYSTEM μ-COM) SCHEMATIC DIAGRAM • See page 4-11 to 4-14 for printed wiring board.

— Ref. No.: MB-83 board; 2,000 series —

1 2 3 4 5 6 7 8 9 10 11 12 13 14 15 16 17 18

MB-83 BOARD (15/16)

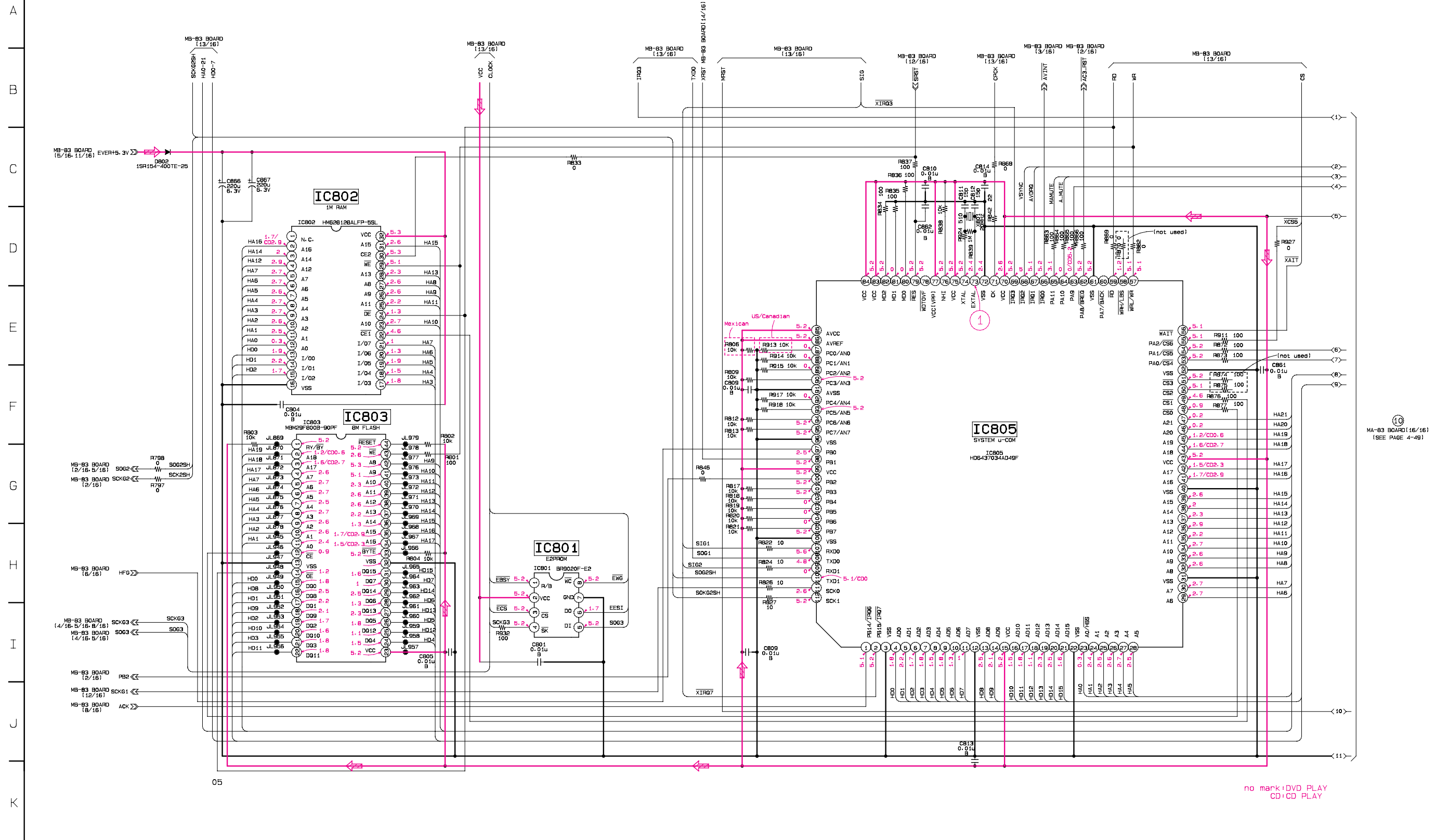

MA-83 BOARD (16/16) (SEE PAGE 4-49)

no mark : DVD PLAY
CD : CD PLAY

MB-83 (S GATE ARRAY) SCHEMATIC DIAGRAM • See page 4-11 to 4-14 for printed wiring board.
 – Ref. No.: MB-83 board; 2,000 series –

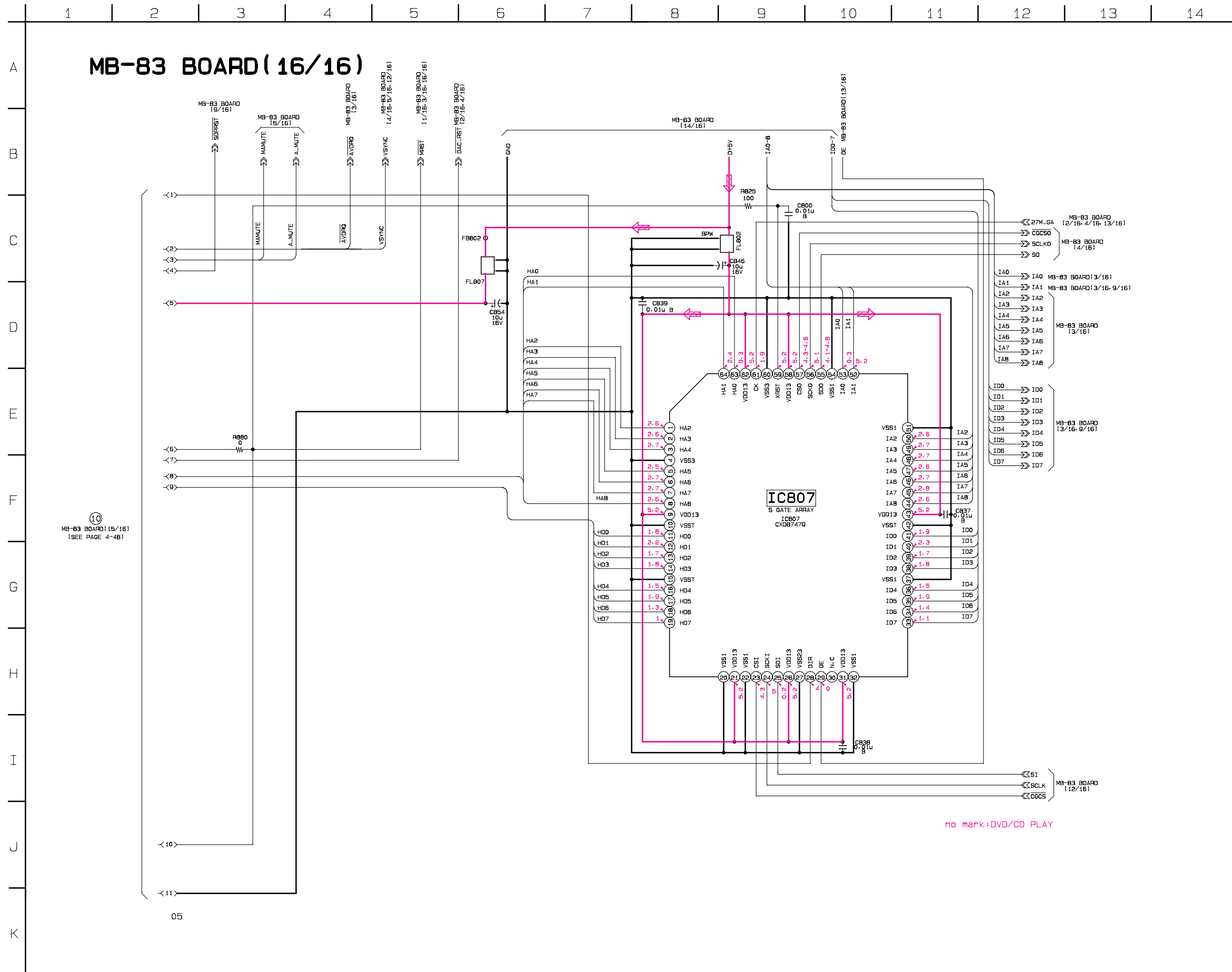

• Waveform

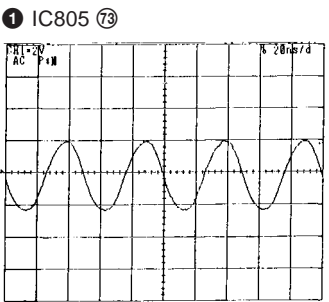

4.4 Vp-p 20 MHz

10
 MB-83 BOARD (15/16)
 (SEE PAGE 4-4B)

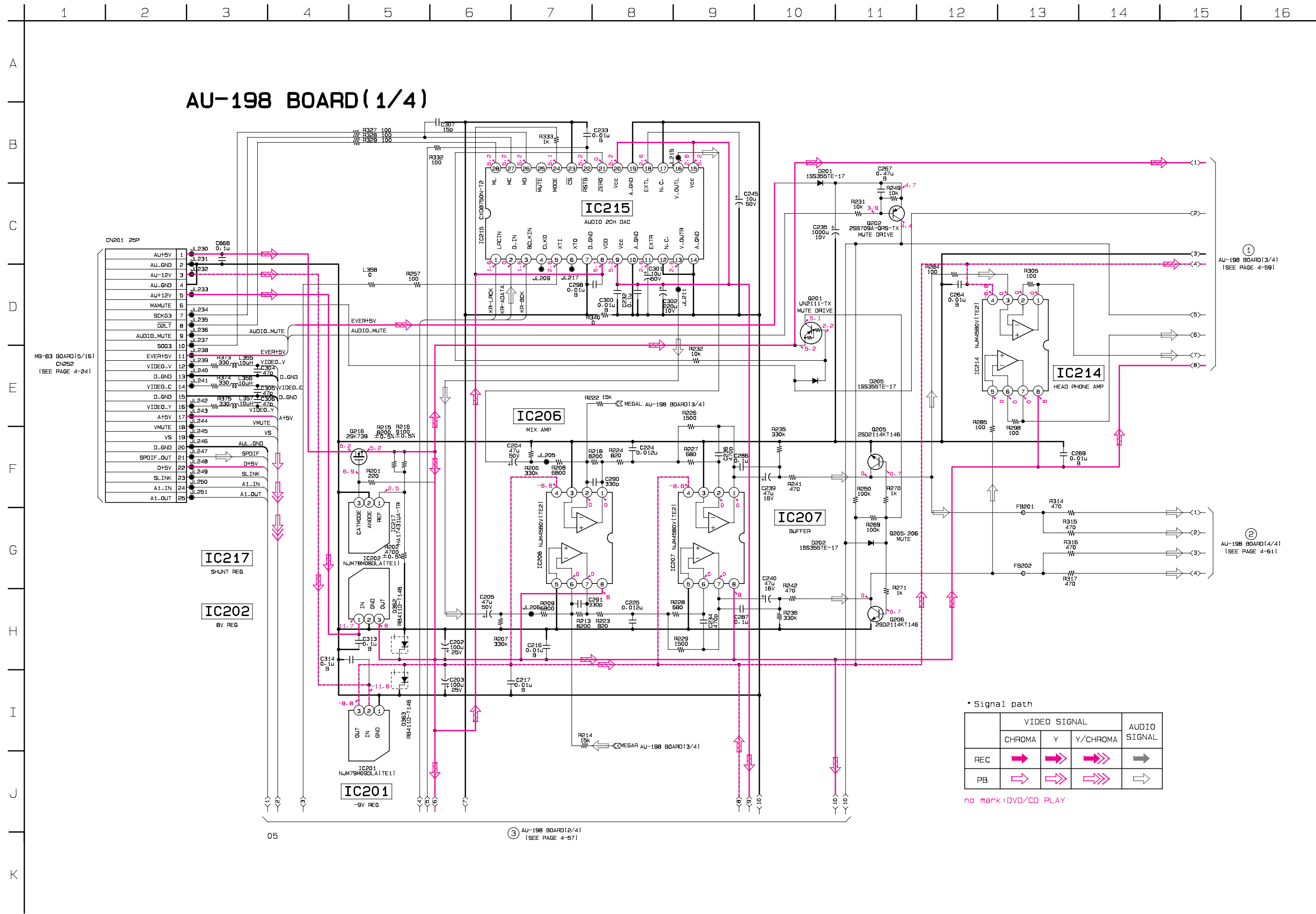

AU-198 (AUDIO 2) SCHEMATIC DIAGRAM • See page 4-51 to 4-54 for printed wiring board.

- Ref. No.: AU-198 board; 1,000 series -

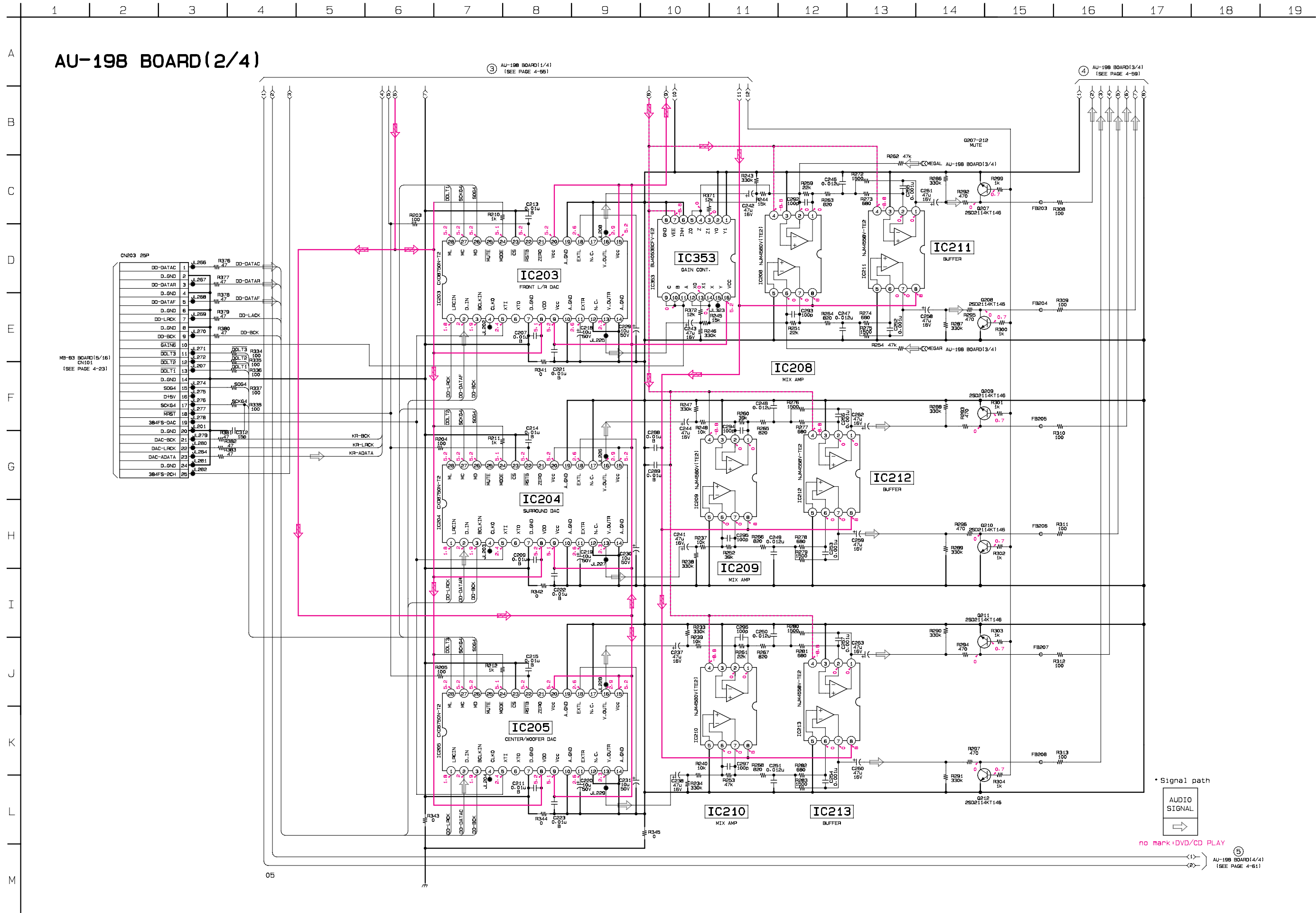

AU-198 (AUDIO 3) SCHEMATIC DIAGRAM • See page 4-51 to 4-54 for printed wiring board.

– Ref. No.: AU-198 board; 1,000 series –

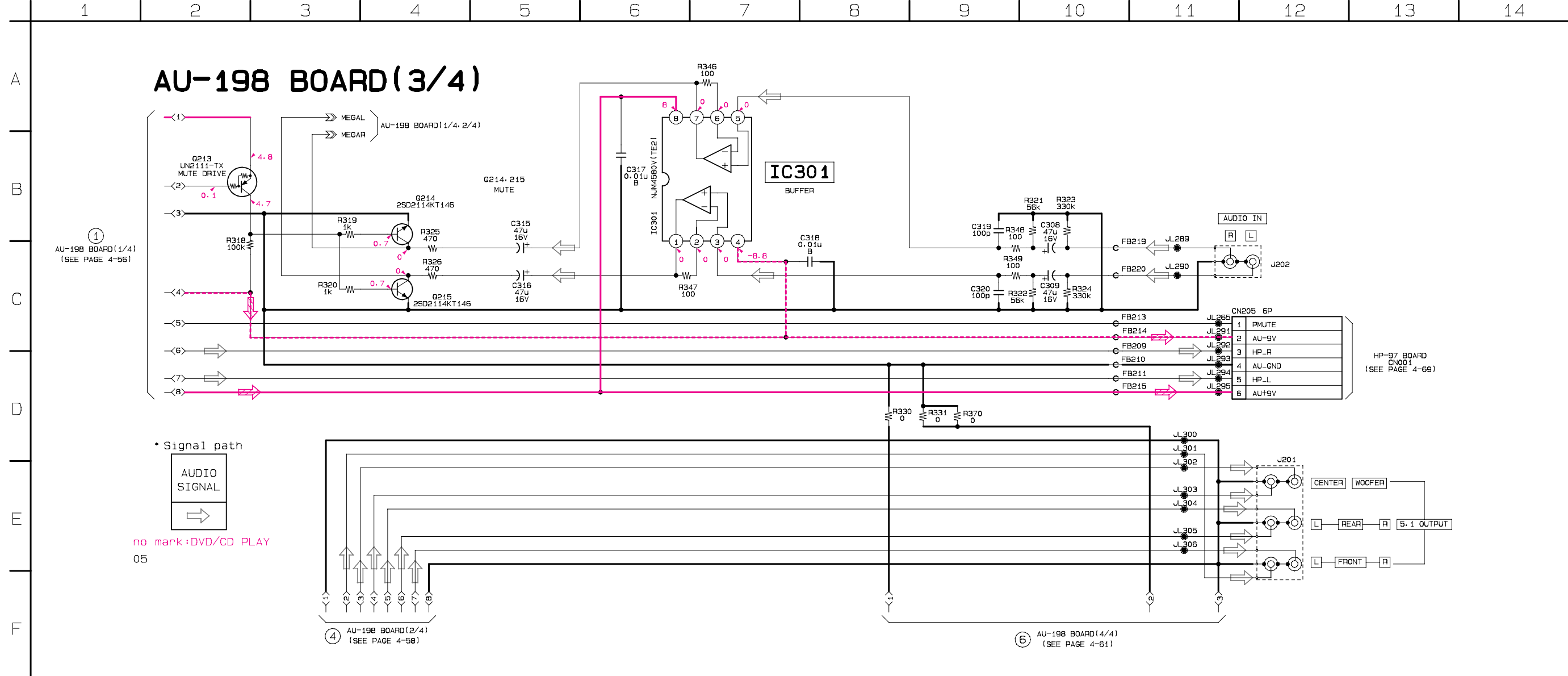

AU-198 (VIDEO BUFFER) SCHEMATIC DIAGRAM • See page 4-51 to 4-54 for printed wiring board.

– Ref. No.: AU-198 board; 1,000 series –

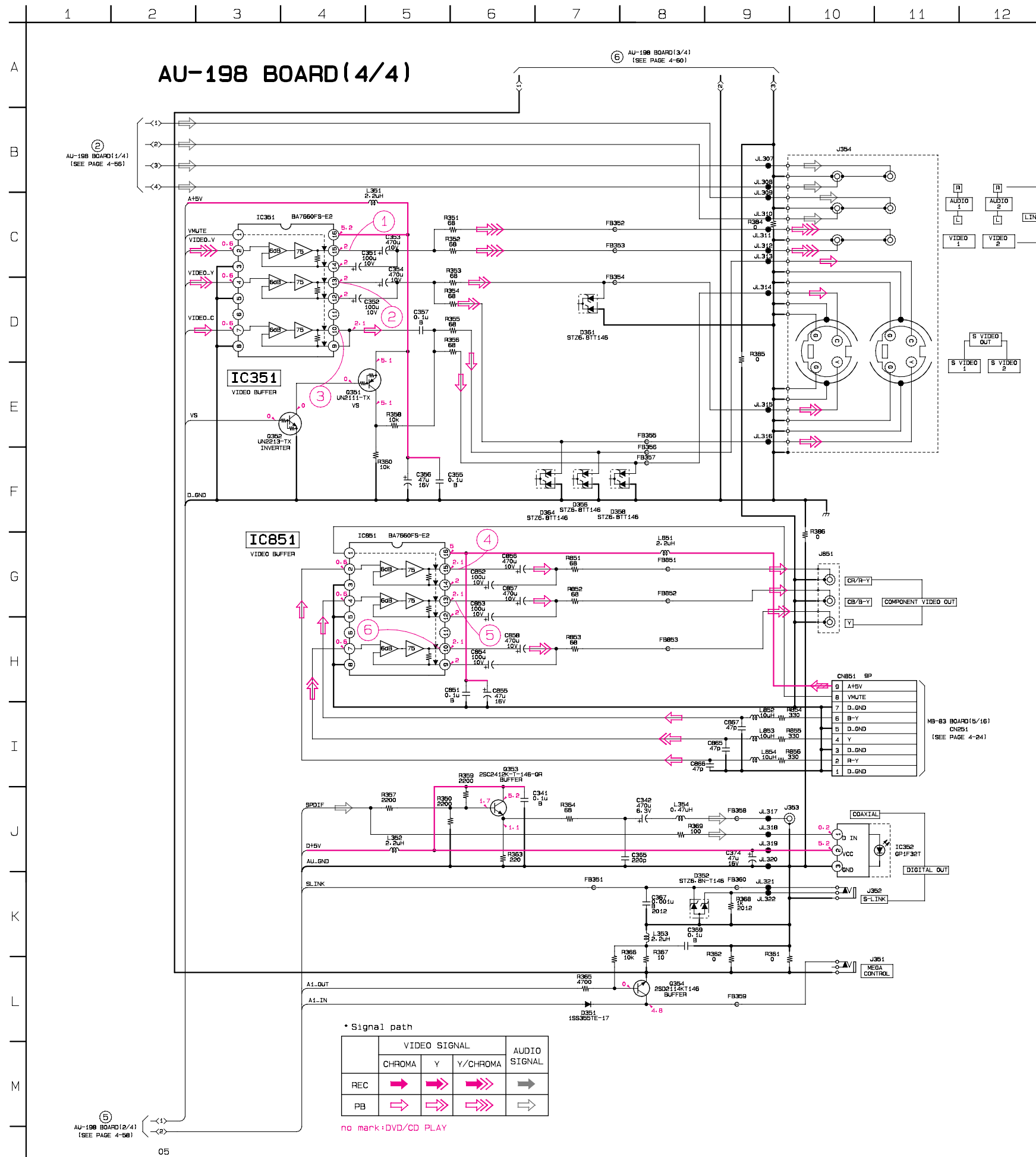

• Waveforms

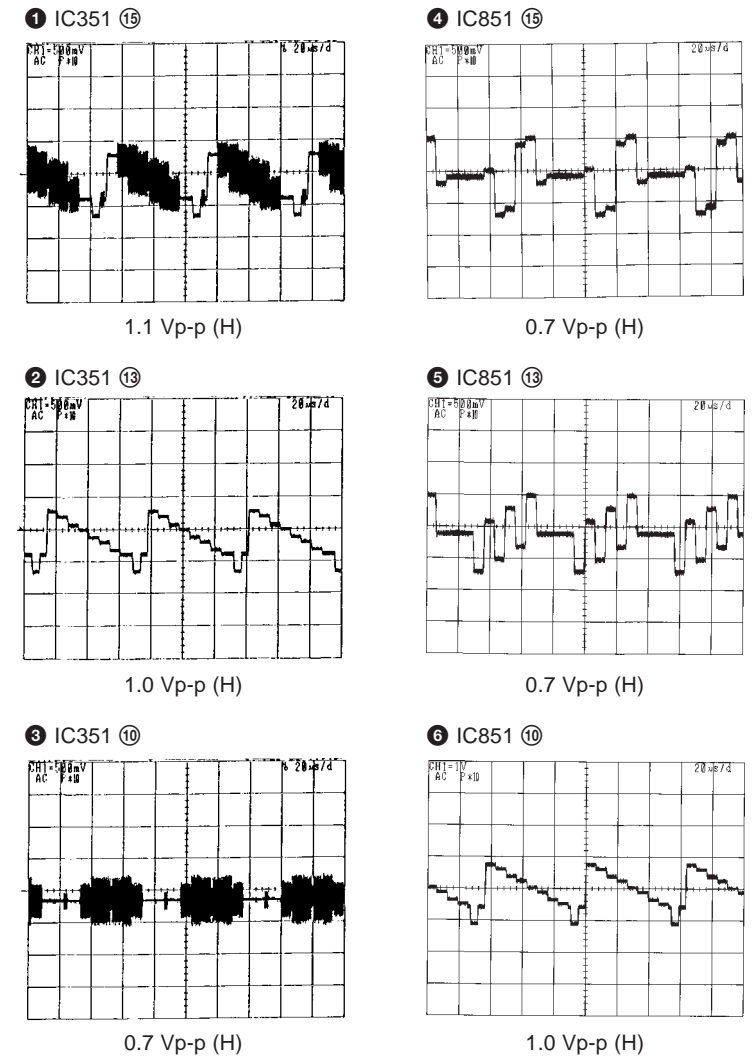

FL-89 (FL DRIVER, FUNCTION SWITCH), LE-20 (LED) SCHEMATIC DIAGRAMS

- Ref. No.: FL-89, LE-20 board; 1,000 series -

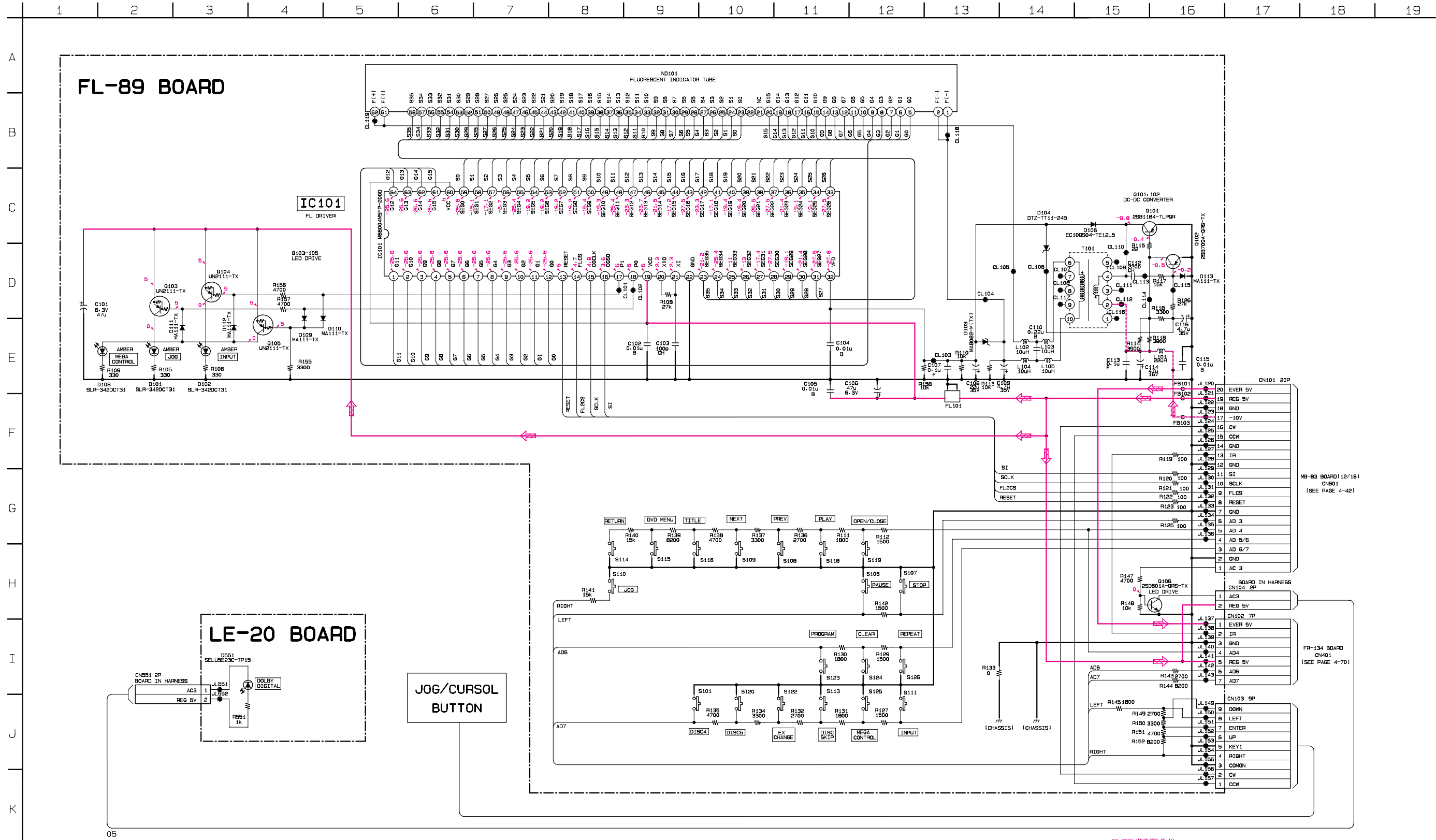

FL DRIVER/FUNCTION SW, LED FL-89, LE-20

HS-934SU (POWER SUPPLY) SCHEMATIC DIAGRAM

– Ref. No.: HS-934SU board; 4,000 series –

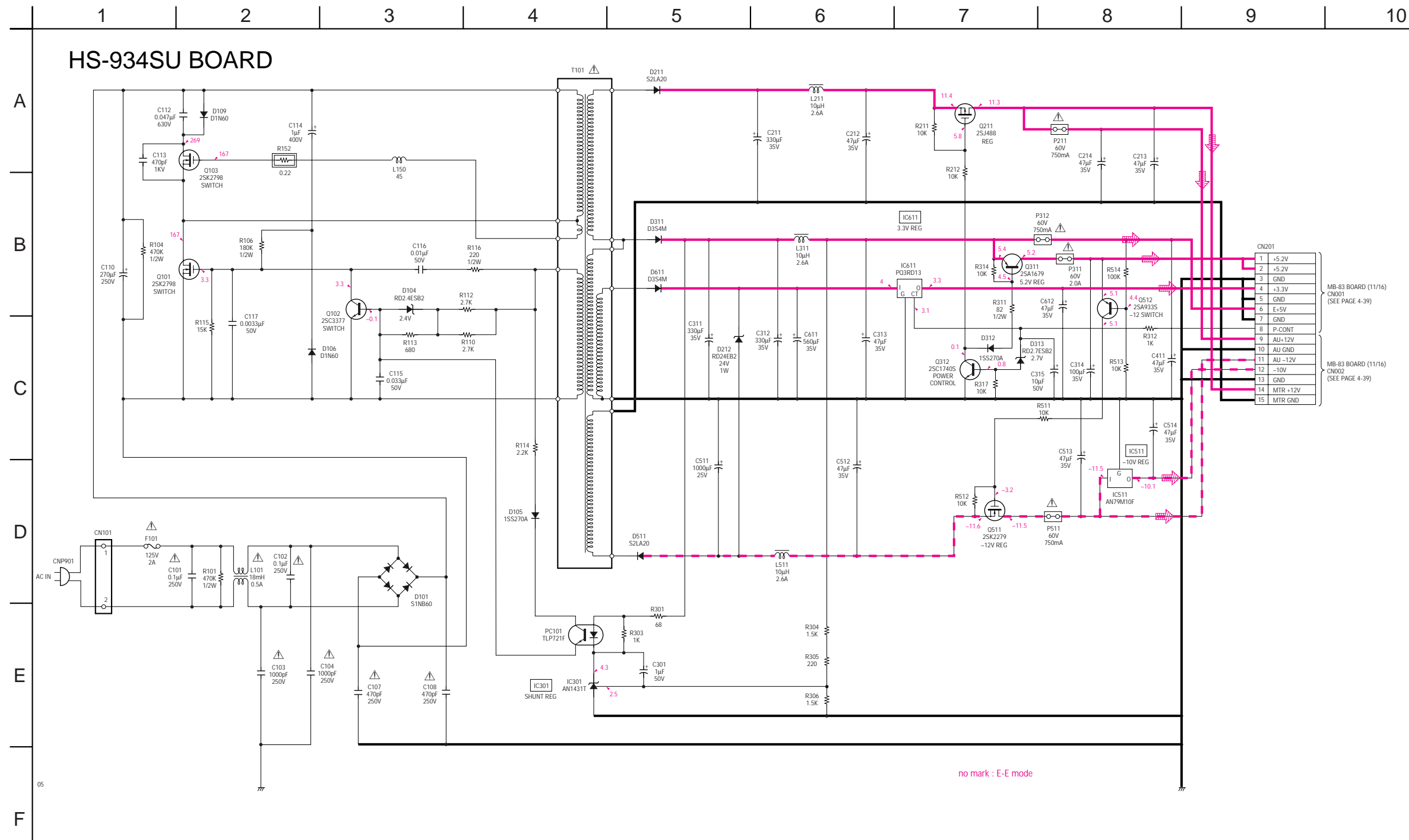

no mark : E-E mode