



# Audio Processor with Pushbutton Interface

MAX5406

## General Description

The MAX5406 stereo audio processor provides a complete audio solution with volume, balance, bass, and treble controls. It features dual 32-tap logarithmic potentiometers for volume control, dual potentiometers for balance control, and linear digital potentiometers for tone control. A simple debounced pushbutton interface controls all functions. The MAX5406 advances the wiper setting once per button push. Maxim's proprietary SmartWiper™ control eliminates the need for a microcontroller ( $\mu\text{C}$ ) to increase the wiper transition rate. Holding the control input low for more than 1s advances the wiper at a rate of 4Hz for 4s and 16Hz thereafter. An integrated click/pop suppression feature eliminates the audible noise generated by the wiper's movements.

The MAX5406 provides a subwoofer output that internally combines the left and right channels. An external filter capacitor allows for a customized cut-off frequency for the subwoofer output. A bass-boost mode enhances the low-frequency response of the left and right channels. An integrated bias amplifier generates the required  $(V_{DD} + V_{SS}) / 2$  bias voltage, eliminating the need for external op amps for unipolar operation.

The MAX5406 also features ambience control to enhance the separation of the left- and right-channel outputs for headphones and desktop speakers systems, and a pseudostereo feature that approximates stereo sound from a monophonic signal.

The MAX5406 is available in a 7mm x 7mm, 48-pin TQFN package and in a 48-pin TSSOP package and is specified over the extended ( $-40^{\circ}\text{C}$  to  $+85^{\circ}\text{C}$ ) temperature range.

## Applications

Automotive Rear-Seat Entertainment (RSE)  
 Desktop Speakers  
 Portable Audio  
 PDAs or MP3 Player Docking Stations  
 Karaoke Machines  
 Flat-Screen TVs

## Features

- ◆ Audio Processor Including All Op Amps and Pots for Volume, Balance, Mute, Bass, Treble, Ambience, Pseudostereo, and Subwoofer
- ◆ 32-Tap Volume Control (2dB Steps)
- ◆ Small, 7mm x 7mm, 48-Pin TQFN and 48-Pin TSSOP Packages
- ◆ Single +2.7V to +5.5V or Dual  $\pm 2.7\text{V}$  Supply Operation
- ◆ Clickless Switching and Control
- ◆ Mute Function to  $< -90\text{dB}$  (typ)
- ◆ Channel Isolation  $> -70\text{dB}$  (typ)
- ◆ Two Sets of Single-Ended or Differential Stereo Inputs Can Be Used for Summing/Mixing
- ◆ Debounced Pushbutton Interface Works with Momentary Contact Switches or Microprocessors ( $\mu\text{Ps}$ )
- ◆ Low  $0.2\mu\text{A}$  (typ) Shutdown Supply Current
- ◆ Shutdown Stores All Control Settings
- ◆  $0.02\%$  (typ) THD into  $10\text{k}\Omega$  Load,  $25\mu\text{V}_{\text{RMS}}$  (typ) Output Noise
- ◆ Internally Generated 1/2 Full-Scale Bias Voltage for Single-Ended Applications
- ◆ Power-On Volume Setting to  $-20\text{dB}$
- ◆ Internal Passive RF Filters for Analog Inputs Prevent High Frequencies from Reaching the Speakers

## Ordering Information

PART	TEMP RANGE	PIN-PACKAGE	PKG CODE
MAX5406EUM	$-40^{\circ}\text{C}$ to $+85^{\circ}\text{C}$	48 TSSOP	U48-1
MAX5406ETM*	$-40^{\circ}\text{C}$ to $+85^{\circ}\text{C}$	48 TQFN	T4877-6

\*Future product—contact factory for availability.

Pin Configurations appear at end of data sheet.

SmartWiper is a trademark of Maxim Integrated Products, Inc.



Maxim Integrated Products 1

**For pricing, delivery, and ordering information, please contact Maxim/Dallas Direct! at 1-888-629-4642, or visit Maxim's website at [www.maxim-ic.com](http://www.maxim-ic.com).**

# Audio Processor with Pushbutton Interface

## ABSOLUTE MAXIMUM RATINGS

L1\_H, L1\_L, L2\_H, L2\_L  
 to V<sub>SS</sub> .....-0.3V to the lower of (V<sub>DD</sub> + 0.3V) or +6V  
 R1\_H, R1\_L, R2\_H, R2\_L  
 to V<sub>SS</sub> .....-0.3V to the lower of (V<sub>DD</sub> + 0.3V) or +6V  
 AMB, BALL, BALR, VOLUP, VOLDN, MUTE, SHDN, BASSDN,  
 BASSUP, TREBDN, TREBUP  
 to DGND .....-0.3V to the lower of (V<sub>LOGIC</sub> + 0.3V) or +6V  
 CTL\_, CTR\_, CBL\_, CBR\_, CLS\_, CRS\_, CSUB, CBIAS, CMSNS,  
 AMBLI, AMBRI, BIAS  
 to V<sub>SS</sub> .....-0.3V to the lower of (V<sub>DD</sub> + 0.3V) or +6V  
 LOUT, ROUT, SUBOUT, LMR,  
 LPR to V<sub>SS</sub>.....-0.3V to the lower of (V<sub>DD</sub> + 0.3V) or +6V

V<sub>DD</sub> to V<sub>SS</sub> .....-0.3V to +6V  
 V<sub>DD</sub> to V<sub>LOGIC</sub>.....±6V  
 V<sub>LOGIC</sub> to DGND .....-0.3V to +6V  
 DGND to V<sub>SS</sub> .....-0.3V to +6V  
 LOUT, ROUT, SUBOUT Short Circuited to V<sub>SS</sub> .....Continuous  
 Continuous Power Dissipation (T<sub>A</sub> = +70°C)  
     48-Pin TQFN (derate 27.8mW/°C above +70°C) .....2222mW  
     48-Pin TSSOP (derate 16mW/°C above +70°C) .....1282mW  
 Operating Temperature Range .....-40°C to +85°C  
 Junction Temperature .....+150°C  
 Storage Temperature Range .....-60°C to +150°C  
 Lead Temperature (soldering, 10s) .....+300°C

Stresses beyond those listed under "Absolute Maximum Ratings" may cause permanent damage to the device. These are stress ratings only, and functional operation of the device at these or any other conditions beyond those indicated in the operational sections of the specifications is not implied. Exposure to absolute maximum rating conditions for extended periods may affect device reliability.

## ELECTRICAL CHARACTERISTICS

(V<sub>DD</sub> = V<sub>LOGIC</sub> = +5.0V, V<sub>SS</sub> = 0, V<sub>BIAS</sub> = V<sub>CMSNS</sub> = V<sub>DD</sub> / 2, DGND = 0, ambience disabled, V<sub>AMBLI</sub> = V<sub>AMBRI</sub> = V<sub>BIAS</sub>, V<sub>R1\_L</sub> = V<sub>L1\_L</sub> = V<sub>R2\_L</sub> = V<sub>L2\_L</sub> = external V<sub>BIAS</sub>, C<sub>CSUB</sub> = 0.15μF, C<sub>CLS</sub> = C<sub>CRS</sub> = 1μF, C<sub>CBL</sub> = C<sub>CBR</sub> = 3.3nF, C<sub>CTL</sub> = C<sub>CTR</sub> = 4.7nF, C<sub>BIAS</sub> = 0.1μF, C<sub>CBIAS</sub> = 50μF (see the *Typical Application Circuit*), T<sub>A</sub> = T<sub>MIN</sub> to T<sub>MAX</sub> unless otherwise specified. Typical values are at T<sub>A</sub> = +25°C). (Note1)

PARAMETER	SYMBOL	CONDITIONS	MIN	TYP	MAX	UNITS
Signal-Inputs Input Resistance	R <sub>IN</sub>	With respect to V <sub>BIAS</sub>	R <sub>INH</sub>	8	10	kΩ
			R <sub>INL</sub>	16	20	
Signal-Inputs Input Capacitance	C <sub>IN</sub>	With respect to V <sub>BIAS</sub>		5		pF
RF Rejection		2MHz to 2.4GHz two-tone test, 2/2.01MHz input to 10kHz out		20		dBc
Differential Input Voltage Range	V <sub>IN</sub>	V <sub>DD</sub> = +5V, V <sub>SS</sub> = 0, V <sub>CM</sub> = V <sub>BIAS</sub> , gain error ≤ -0.5dB	-4		+4	V
		V <sub>DD</sub> = +2.7V, V <sub>SS</sub> = -2.7V, V <sub>CM</sub> = V <sub>BIAS</sub> , gain error ≤ -0.5dB	-4.5		+4.5	
Common-Mode Input Voltage Range	V <sub>CM</sub>	V <sub>DD</sub> = +5V, V <sub>SS</sub> = 0, V <sub>BIAS</sub> = V <sub>DD</sub> / 2, V <sub>DIFF</sub> = 100mV	V <sub>SS</sub> + 0.5V	V <sub>DD</sub> - 0.5V		V
		V <sub>DD</sub> = +2.7V, V <sub>SS</sub> = -2.7V, V <sub>BIAS</sub> = 0, V <sub>DIFF</sub> = 100mV				
Bias Voltage	V <sub>BIAS</sub>	Internally generated (V <sub>CMSNS</sub> = V <sub>SS</sub> )	(V <sub>DD</sub> + V <sub>SS</sub> ) / 2			V
Bias-Voltage Input Current		L <sub>_H</sub> = R <sub>_H</sub> = V <sub>BIAS</sub> , L <sub>_L</sub> = R <sub>_L</sub> = open, V <sub>CMSNS</sub> = V <sub>DD</sub>	1			mA

## AUDIO PROCESSING FUNCTIONS

Maximum Balance Difference		(Note 2)	10	12	14	dB
Minimum Balance Difference		(Note 2)		0		dB
Balance Resolution		(Note 2)		2		dB
Maximum Volume Attenuation		(Note 2)	-63	-62	-59	dB
Minimum Volume Attenuation		(Note 2)	-0.5	0	+0.5	dB
Volume Resolution		(Note 2)		2		dB
Volume-Control Steps		(Note 2)		32		steps

# Audio Processor with Pushbutton Interface

MAX5406

## ELECTRICAL CHARACTERISTICS (continued)

(V<sub>DD</sub> = V<sub>LOGIC</sub> = +5.0V, V<sub>SS</sub> = 0, V<sub>BIAS</sub> = V<sub>CMSNS</sub> = V<sub>DD</sub> / 2, DGND = 0, ambience disabled, V<sub>AMBLI</sub> = V<sub>AMBRI</sub> = V<sub>BIAS</sub>, V<sub>R1\_L</sub> = V<sub>L1\_L</sub> = V<sub>R2\_L</sub> = V<sub>L2\_L</sub> = external V<sub>BIAS</sub>, C<sub>CSUB</sub> = 0.15μF, C<sub>CLS</sub> = C<sub>CRS</sub> = 1μF, C<sub>CBL</sub> = C<sub>CBR</sub> = 3.3nF, C<sub>CTL</sub> = C<sub>CTR</sub> = 4.7nF, C<sub>BIAS</sub> = 0.1μF, C<sub>CBIAS</sub> = 50μF (see the *Typical Application Circuit*), T<sub>A</sub> = T<sub>MIN</sub> to T<sub>MAX</sub> unless otherwise specified. Typical values are at T<sub>A</sub> = +25°C). (Note1)

PARAMETER	SYMBOL	CONDITIONS	MIN	TYP	MAX	UNITS
Gain Matching of Input 1 to Input 2 of Each Channel		Volume = 0dB (Note 2)	-0.1		+0.1	dB
Gain Matching of Left to Right Channel		Volume = 0dB (Note 2)	-0.1		+0.1	dB
Bass-Boost Range		f <sub>BASS</sub> = 1kHz, treble = 0dB, C <sub>CB_</sub> = open, C <sub>CT_</sub> = open (Note 3)	10	14		dB
Bass-Cut Range		f <sub>BASS</sub> = 1kHz, treble = 0dB, C <sub>CB_</sub> = open, C <sub>CT_</sub> = open (Note 3)	10	14		dB
Treble-Boost Range		f <sub>TREBLE</sub> = 1kHz, bass = 0dB, C <sub>CB_</sub> = open, C <sub>CT_</sub> = short (Note 3)	10	15		dB
Treble-Cut Range		f <sub>TREBLE</sub> = 1kHz, bass = 0dB, C <sub>CB_</sub> = open, C <sub>CT_</sub> = short (Note 3)	10	15		dB
Bass-Boost/-Cut Steps		Max boost to max cut		21		steps
Treble-Boost/-Cut Steps		Max boost to max cut		21		steps
Bass End-to-End Resistance	R <sub>BPOT</sub>			116		kΩ
Treble End-to-End Resistance	R <sub>TPOT</sub>			17		kΩ
Bass Series Resistance	R <sub>B</sub>			40		kΩ
Treble Series Resistance	R <sub>T</sub>			3.5		kΩ
Mute Attenuation				-90		dB
<b>AC PERFORMANCE (V<sub>IN</sub> = 1V<sub>P-P</sub>, R<sub>L</sub> = 10kΩ, V<sub>DD</sub> = +2.7V, V<sub>SS</sub> = -2.7V, volume = 0dB, treble = bass = 0dB)</b>						
Total Harmonic Distortion Plus Noise	THD+N	(Notes 4, 5)		0.02	0.05	%
Interchannel Crosstalk		L to R or R to L		-70		dB
<b>ROUT/LOUT OUTPUTS</b>						
Maximum Load Capacitance	C <sub>LOAD</sub>			100		pF
Output-Voltage Swing	V <sub>OUTP-P</sub>	R <sub>L</sub> = 10kΩ, V <sub>DD</sub> = +2.7V, V <sub>SS</sub> = -2.7V	-2.3		+2.3	V
Output Offset Voltage	V <sub>OOS</sub>	V <sub>DD</sub> = +2.7V, V <sub>SS</sub> = -2.7V, volume = 0dB, R <sub>L</sub> = 10kΩ, inputs = V <sub>BIAS</sub>	-30	0	+30	mV
Short-Circuit Output Current	I <sub>SC</sub>	Shorted to V <sub>SS</sub>		15		mA
Output Resistance	R <sub>OUT</sub>	I <sub>LOAD</sub> = 100μA to 500μA			10	Ω

# Audio Processor with Pushbutton Interface

## ELECTRICAL CHARACTERISTICS (continued)

( $V_{DD} = V_{LOGIC} = +5.0V$ ,  $V_{SS} = 0$ ,  $V_{BIAS} = V_{CMSNS} = V_{DD} / 2$ ,  $DGND = 0$ , ambient disabled,  $V_{AMBLI} = V_{AMBRI} = V_{BIAS}$ ,  $V_{R1\_L} = V_{L1\_L} = V_{R2\_L} = V_{L2\_L} = \text{external } V_{BIAS}$ ,  $C_{CSUB} = 0.15\mu F$ ,  $C_{CLS} = C_{CRS} = 1\mu F$ ,  $C_{CBL} = C_{CBR} = 3.3nF$ ,  $C_{CTL} = C_{CTR} = 4.7nF$ ,  $C_{BIAS} = 0.1\mu F$ ,  $C_{CBIAS} = 50\mu F$  (see the *Typical Application Circuit*),  $T_A = T_{MIN}$  to  $T_{MAX}$  unless otherwise specified. Typical values are at  $T_A = +25^\circ C$ ). (Note1)

PARAMETER	SYMBOL	CONDITIONS	MIN	TYP	MAX	UNITS
Output Noise	$e_n$	$f_{BW} = 20\text{Hz to } 20\text{kHz}$ , $V_{IN} = V_{BIAS}$ , mute on, noise measured at LOUT and ROUT (Notes 2, 4, 5)		3.5	9.5	$\mu V_{RMS}$
		$f_{BW} = 20\text{Hz to } 20\text{kHz}$ , $V_{IN} = V_{BIAS}$ , mute off, volume = 0dB, noise measured at LOUT and ROUT (Notes 2, 4, 5)		25	35	
Power-Supply Rejection Ratio	PSRR	100mV <sub>P-P</sub> at 217Hz on $V_{DD}$		-70		dB
		100mV <sub>P-P</sub> at 1kHz on $V_{DD}$		-65		
<b>SUBWOOFER OUTPUT</b>						
Gain		( $V_{L1\_H} - V_{L1\_L}$ ) to ( $V_{SUBOUT} - V_{BIAS}$ ), volume = 0dB (Note 2)		-6		dB
Highpass Filter Cutoff Frequency		Volume = 0dB		15		Hz
Internal Highpass Cutoff Resistance	$R_S$	Figure 12		13.8		k $\Omega$
Lowpass Filter Cutoff Frequency		Volume = 0dB		100		Hz
Internal Lowpass Cutoff Resistance	$R_{SUB}$	Figure 12		10.6		k $\Omega$
Maximum Load Capacitance	$C_{SUBLOAD}$			100		pF
Output-Voltage Swing	$V_{SUBOUTP-P}$	$R_L = 10k\Omega$ , $V_{DD} = +2.7V$ , $V_{SS} = -2.7V$	-2.3		+2.3	V
Output Offset Voltage	$V_{SUBOOS}$	$V_{DD} = +2.7V$ , $V_{SS} = -2.7V$ , volume = 0dB, $R_L = 10k\Omega$	-15	0	+15	mV
Short-Circuit Output Current	$I_{SUBSC}$	Shorted to $V_{SS}$		12		mA
Output Resistance	$R_{SUBOUT}$	$I_{LOAD} = 100\mu A$ to $500\mu A$			10	$\Omega$
Output Noise	$e_n$	$f_{BW} = 20\text{Hz to } 20\text{kHz}$ , $V_{IN} = V_{BIAS}$ , mute on, noise measured at SUBOUT (Notes 2, 4, 5)		9	11	$\mu V_{RMS}$
		$f_{BW} = 20\text{Hz to } 20\text{kHz}$ , $V_{IN} = V_{BIAS}$ , volume = 0dB, mute off, noise measured at SUBOUT (Notes 2, 4, 5)		25	35	
Power-Supply Rejection Ratio	PSRR	100mV <sub>P-P</sub> at 217Hz on $V_{DD}$		-70		dB
		100mV <sub>P-P</sub> at 1kHz on $V_{DD}$		-65		
<b>PUSHBUTTON CONTACT INPUTS (MUTE, AMB, VOLUP, VOLDN, BALL, BALR, BASSUP, BASSDN, TREBUP, TREBDN)</b>						
Internal Pullup Resistor	$R_{PU}$			50		k $\Omega$
Single-Pulse Input Low Time	$t_{LPW}$	Figures 2a, 11a, 11b		30		ms
Repetitive Input Pulse Separation Time	$t_{HPW}$	Figure 2b, 11a, 11b		40		ms
First Autoincrement Point	$t_{A1}$	Figure 3		1		s
First Autoincrement Rate	$f_{A1}$	Figure 3		4		Hz
Second Autoincrement Point	$t_{A2}$	Figure 3		4		s
Second Autoincrement Rate	$f_{A2}$	Figure 3		16		Hz

# Audio Processor with Pushbutton Interface

MAX5406

## ELECTRICAL CHARACTERISTICS (continued)

( $V_{DD} = V_{LOGIC} = +5.0V$ ,  $V_{SS} = 0$ ,  $V_{BIAS} = V_{CMSNS} = V_{DD} / 2$ ,  $DGND = 0$ , ambience disabled,  $V_{AMBLI} = V_{AMBRI} = V_{BIAS}$ ,  $V_{R1\_L} = V_{L1\_L} = V_{R2\_L} = V_{L2\_L} = \text{external } V_{BIAS}$ ,  $C_{CSUB} = 0.15\mu F$ ,  $C_{CLS} = C_{CRS} = 1\mu F$ ,  $C_{CBL} = C_{CBR} = 3.3nF$ ,  $C_{CTL} = C_{CTR} = 4.7nF$ ,  $C_{BIAS} = 0.1\mu F$ ,  $C_{CBIAS} = 50\mu F$  (see the *Typical Application Circuit*),  $T_A = T_{MIN}$  to  $T_{MAX}$  unless otherwise specified. Typical values are at  $T_A = +25^\circ C$ ). (Note1)

PARAMETER	SYMBOL	CONDITIONS	MIN	TYP	MAX	UNITS	
<b>DIGITAL INPUTS (<math>V_{LOGIC} &gt; 3.6V</math>) (MUTE, AMB, VOLUP, VOLDN, BALL, BALR, BASSUP, BASSDN, TREBUP, TREBDN)</b>							
Input-Voltage High	$V_{IH}$		2.4			V	
Input-Voltage Low	$V_{IL}$				0.8	V	
$\overline{SHDN}$ Input-Voltage High	$V_{IHSHDN}$		3.4			V	
$\overline{SHDN}$ Input-Voltage Low	$V_{ILSHDN}$				0.8	V	
Input Leakage Current					$\pm 5$	$\mu A$	
Input Capacitance				5		pF	
<b>DIGITAL INPUTS (<math>V_{LOGIC} \leq 3.6V</math>) (MUTE, AMB, VOLUP, VOLDN, BALL, BALR, BASSUP, BASSDN, TREBUP, TREBDN)</b>							
Input-Voltage High	$V_{IH}$		2			V	
Input-Voltage Low	$V_{IL}$				0.6	V	
$\overline{SHDN}$ Input-Voltage High	$V_{IHSHDN}$		2			V	
$\overline{SHDN}$ Input-Voltage Low	$V_{ILSHDN}$				0.6	V	
Input Leakage Current					$\pm 5$	$\mu A$	
Input Capacitance				5		pF	
<b>TIMING CHARACTERISTICS</b>							
Wiper Settling Time	$t_{WS}$	Click/pop suppression inactive, Figures 2a, 11a, 11b		45		ms	
<b>POWER SUPPLIES (<math>V_{CMSNS} = V_{SS}</math>, internal bias enabled)</b>							
Supply-Voltage Difference	$V_{DD} - V_{SS}$				+5.5	V	
Positive Analog Supply Voltage	$V_{DD}$		+2.7		+5.5	V	
Negative Analog Supply Voltage	$V_{SS}$		-2.7		0	V	
Dual-Supply Positive Supply Voltage	$V_{DD}$	$V_{SS} = -2.7V$	0		+2.7	V	
Active Positive Supply Current	$I_{DD}$	No signal, all logic inputs pulled high to $V_{LOGIC}$ or unconnected, $\overline{SHDN} = V_{LOGIC}$ , $R_L = 10k\Omega$ (Note 6)		10	13	mA	
Active Negative Supply Current (Note 6)	$I_{SS}$	No signal, all logic inputs connected to DGND or $V_{LOGIC}$ , $V_{DD} = +5V$ , $V_{SS} = 0$	-13	-10		mA	
		No signal, all logic inputs connected to DGND or $V_{LOGIC}$ , $V_{DD} = +2.7V$ , $V_{SS} = -2.7V$	-13	-10			
Shutdown Supply Current (Note 6)	$I_{SHDN}$	No signal, $V_{DD} = 5V$ , $V_{SS} = 0$ , all logic inputs connected to DGND or $V_{LOGIC}$ , $\overline{SHDN} = DGND$		0.2		$\mu A$	
		No signal, $V_{DD} = +2.7V$ , $V_{SS} = -2.7V$ , all logic at DGND or $V_{LOGIC}$ , $\overline{SHDN} = DGND$	$I_{DD}$		0.2		
			$I_{SS}$				50

# Audio Processor with Pushbutton Interface

## ELECTRICAL CHARACTERISTICS (continued)

( $V_{DD} = V_{LOGIC} = +5.0V$ ,  $V_{SS} = 0$ ,  $V_{BIAS} = V_{CMSNS} = V_{DD} / 2$ ,  $DGND = 0$ , ambience disabled,  $V_{AMBLI} = V_{AMBRI} = V_{BIAS}$ ,  $V_{R1\_L} = V_{L1\_L} = V_{R2\_L} = V_{L2\_L} = \text{external } V_{BIAS}$ ,  $C_{CSUB} = 0.15\mu F$ ,  $C_{CLS} = C_{CRS} = 1\mu F$ ,  $C_{CBL} = C_{CBR} = 3.3nF$ ,  $C_{CTL} = C_{CTR} = 4.7nF$ ,  $C_{BIAS} = 0.1\mu F$ ,  $C_{CBIAS} = 50\mu F$  (see the *Typical Application Circuit*),  $T_A = T_{MIN}$  to  $T_{MAX}$  unless otherwise specified. Typical values are at  $T_A = +25^\circ C$ ). (Note 1)

PARAMETER	SYMBOL	CONDITIONS	MIN	TYP	MAX	UNITS
Power-Up Time	$t_{PU}$	Power first applied, $\_OUT = -20dB$		1		s
Wake-Up Time	$t_{WU}$	From shutdown (Note 7)		1		s
Logic Supply Voltage	$V_{LOGIC}$	$DGND = 0$ , $V_{LOGIC} \leq V_{DD}$	+2.7		$V_{DD}$	V
Logic Active Supply Current	$I_{LOGIC}$	No signal, one button pressed, remaining logic inputs connected to $V_{LOGIC}$ or unconnected			150	$\mu A$
Logic Shutdown Supply Current		No signal, all logic inputs connected to $V_{LOGIC}$ or unconnected, $\overline{SHDN} = DGND$ (Note 6)		0.2	2	$\mu A$

**Note 1:** All devices 100% production tested at  $T_A = +85^\circ C$ . Limits over the operating temperature range are guaranteed by design.

**Note 2:** Treble = bass = 0dB.  $C_{CB\_} = \text{open}$ ,  $C_{CT\_} = \text{short}$ , left input signal = right input signal = +2V.

**Note 3:** See Tables 3 and 4 and Figure 7.  $V_{DD} = +2.7V$ ,  $V_{SS} = -2.7V$ .

**Note 4:** Guaranteed by design.

**Note 5:** Measured with A-weighted filter.

**Note 6:** Supply current measured while attenuator position is fixed.

**Note 7:** Set  $\_OUT = 0dB$  and shutdown device  $\overline{SHDN} = 0$ .  $t_{WU}$  is the time required for  $\_OUT$  to reach 0dB after  $\overline{SHDN}$  goes high.

## Typical Operating Characteristics

( $T_A = +25^\circ C$ , unless otherwise noted.)

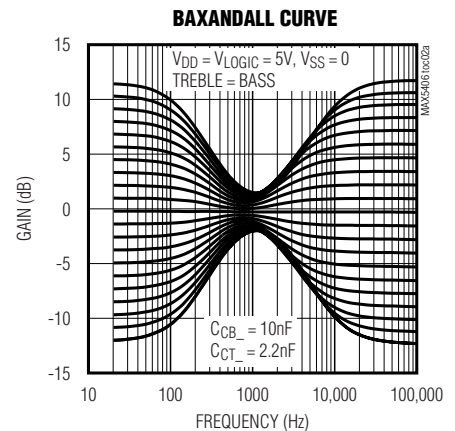
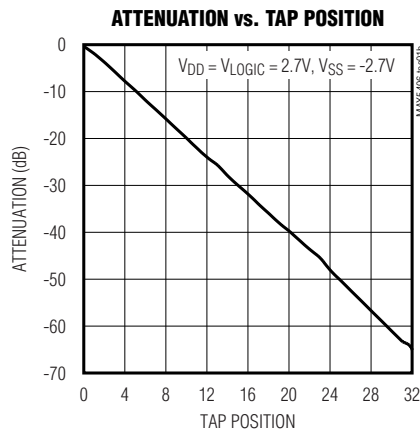
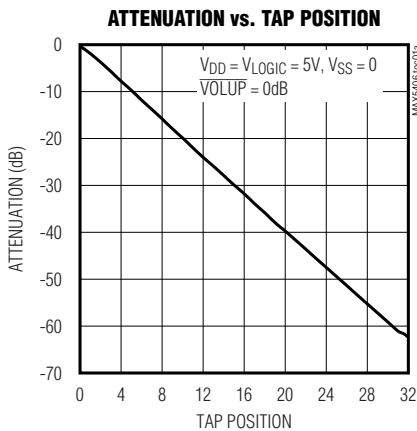

# Audio Processor with Pushbutton Interface

MAX5406

## Typical Operating Characteristics (continued)

( $T_A = +25^\circ\text{C}$ , unless otherwise noted.)

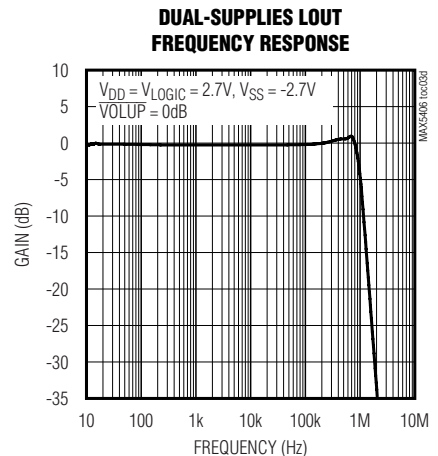
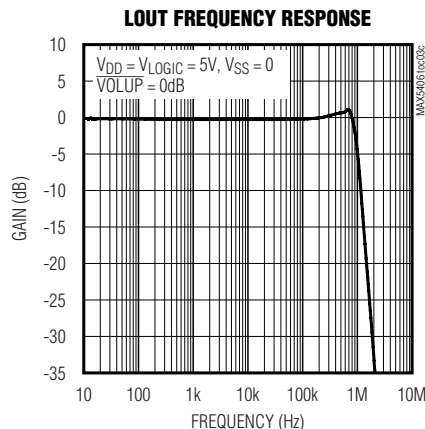
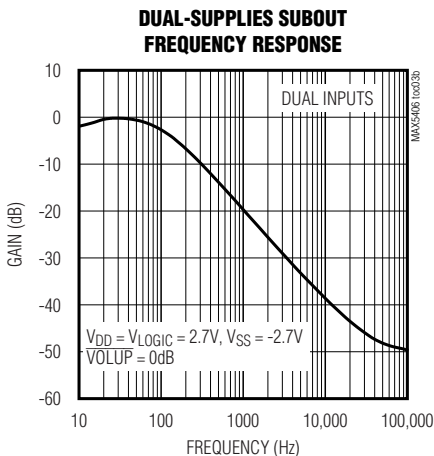
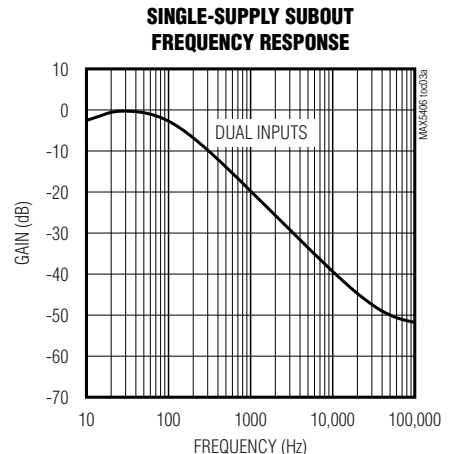
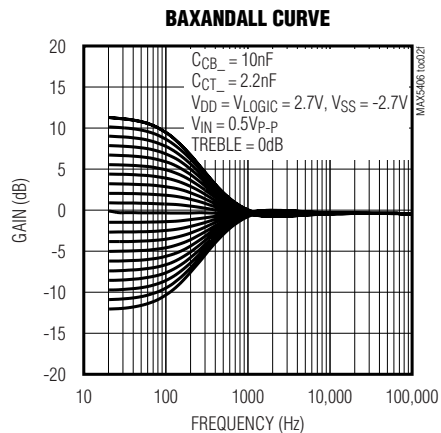
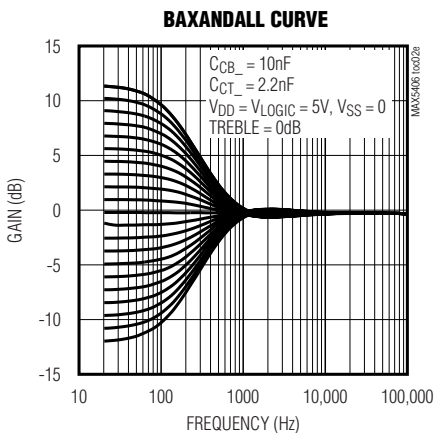
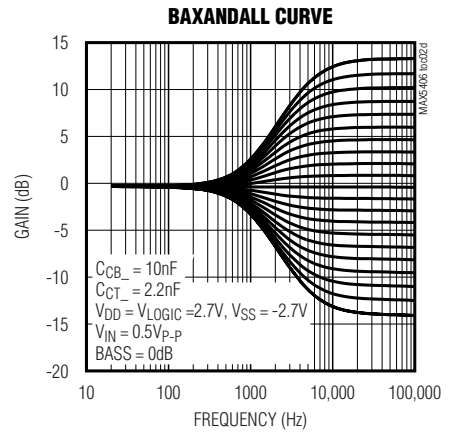
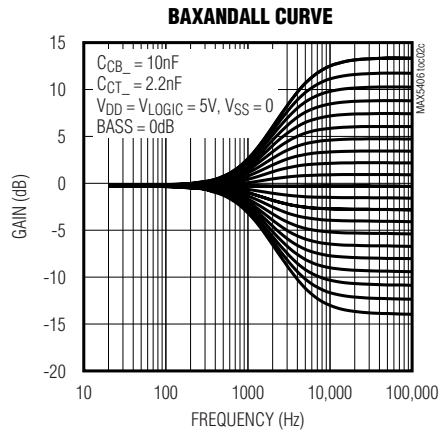
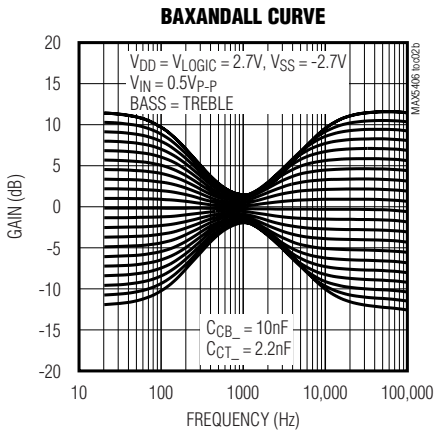

# Audio Processor with Pushbutton Interface

## Typical Operating Characteristics (continued)

( $T_A = +25^\circ\text{C}$ , unless otherwise noted.)

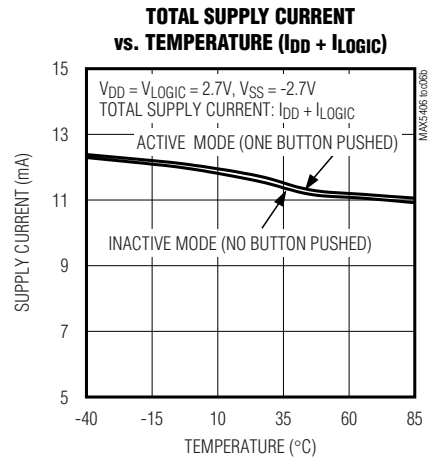
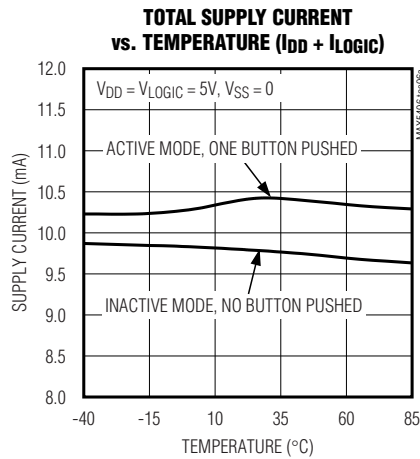
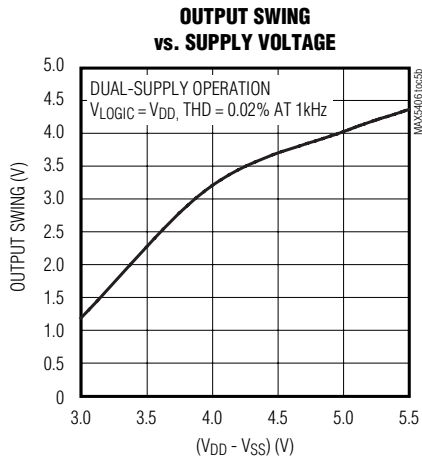
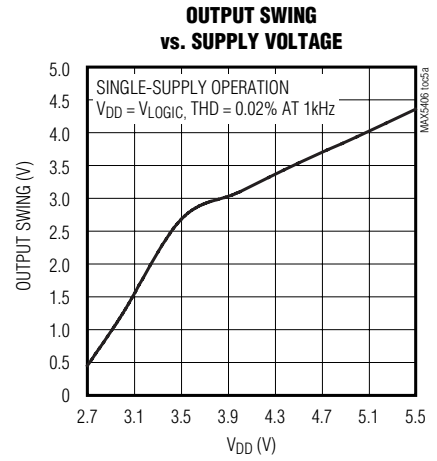
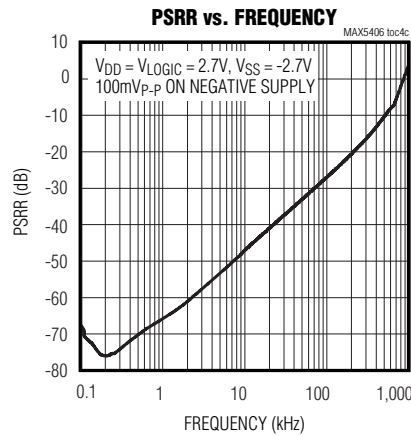
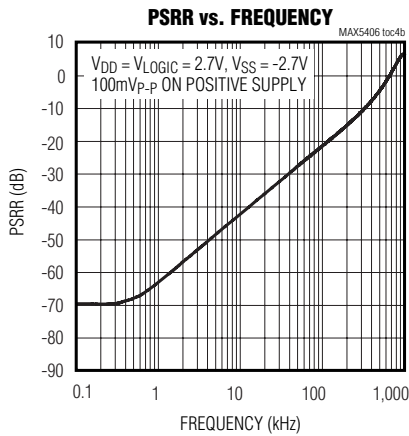
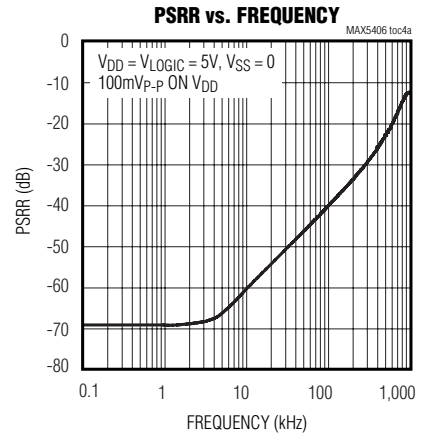
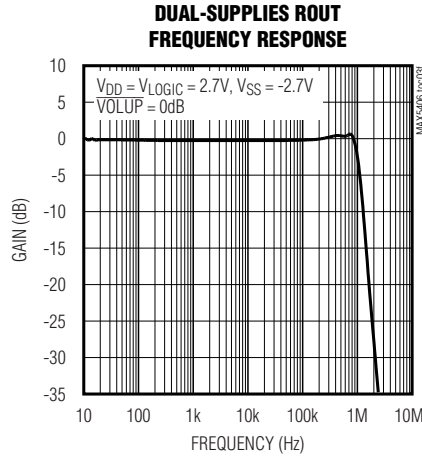
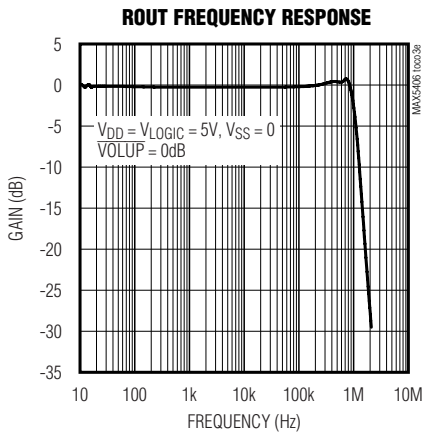



# Audio Processor with Pushbutton Interface

MAX5406

## Typical Operating Characteristics (continued)

( $T_A = +25^\circ\text{C}$ , unless otherwise noted.)

WIPER SWITCHING TRANSIENT

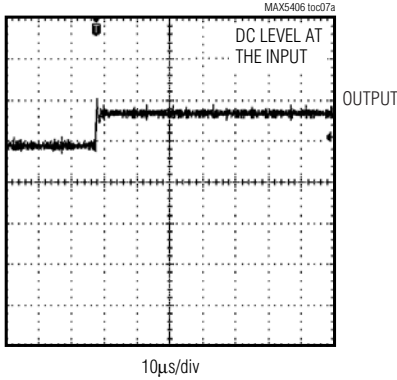

WIPER SWITCHING TRANSIENT (SUPPRESSION CIRCUIT ACTIVE)

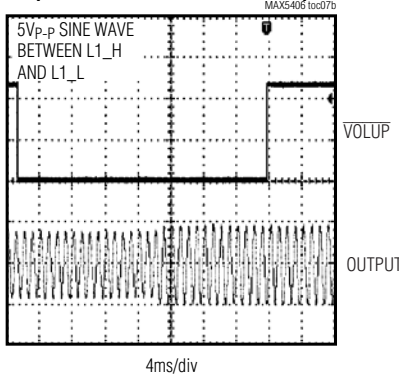

I<sub>LOGIC</sub> vs. V<sub>LOGIC</sub>

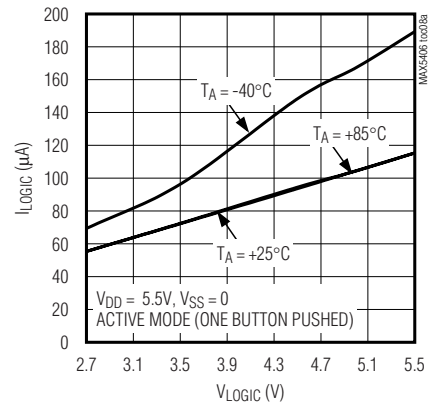

I<sub>LOGIC</sub> vs. V<sub>LOGIC</sub>

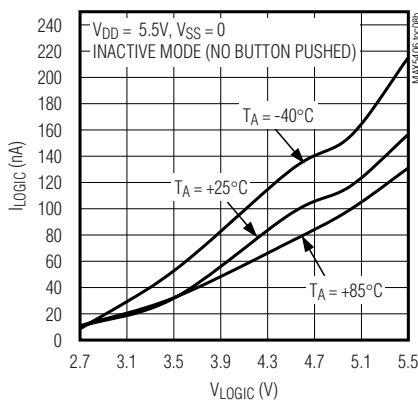

THD PLUS NOISE vs. FREQUENCY

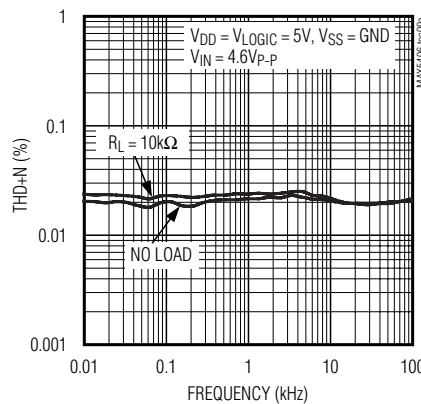

THD PLUS NOISE vs. FREQUENCY

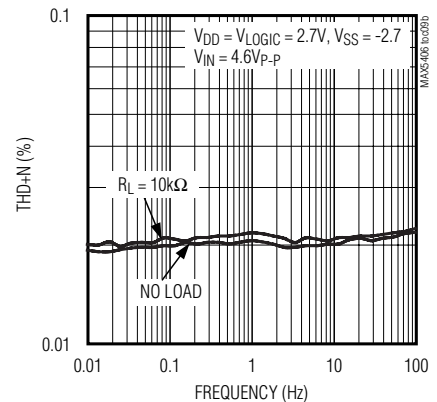

CROSSTALK vs. FREQUENCY

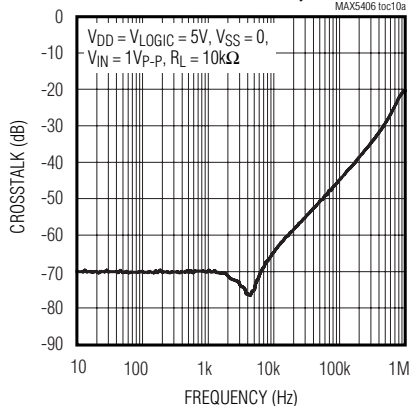

CROSSTALK vs. FREQUENCY

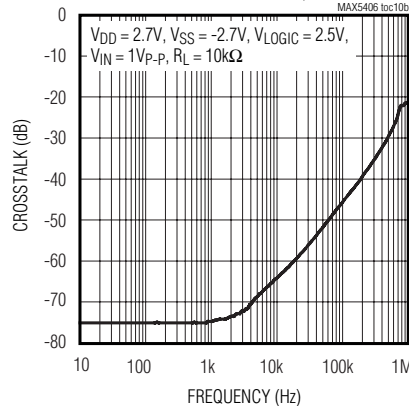

TOTAL SUPPLY CURRENT vs. SUPPLY VOLTAGE ( $I_{DD} + I_{LOGIC}$ )

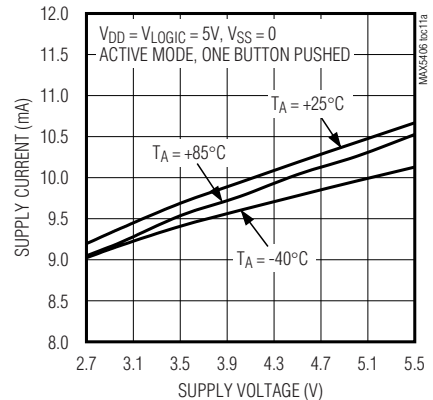

# Audio Processor with Pushbutton Interface

## Typical Operating Characteristics (continued)

( $T_A = +25^\circ\text{C}$ , unless otherwise noted.)

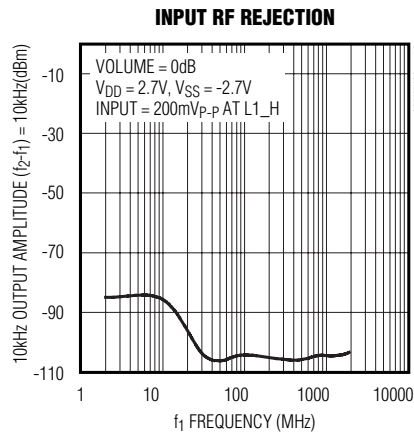
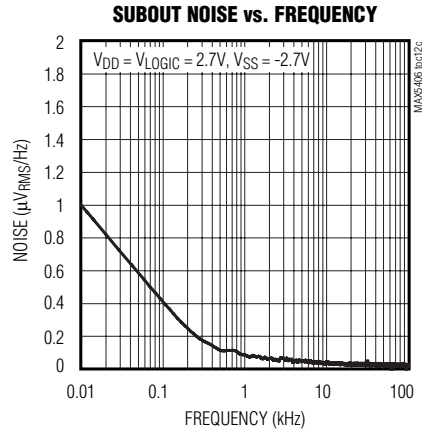
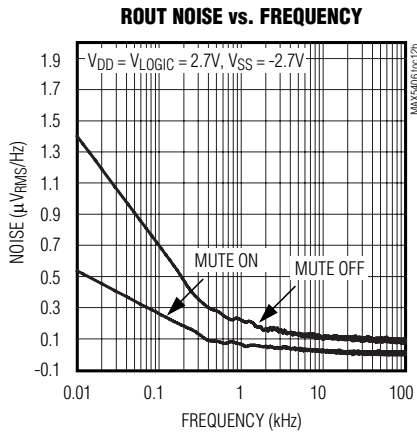
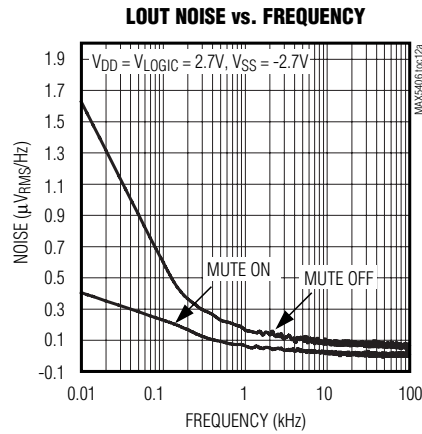
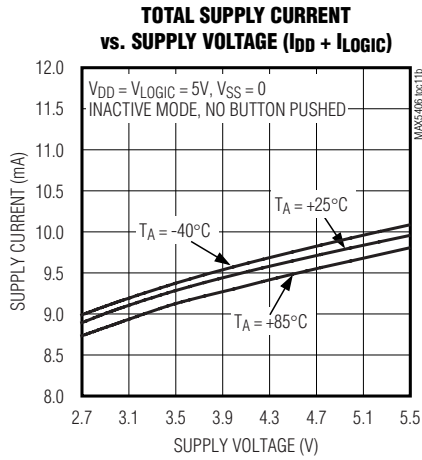

# Audio Processor with Pushbutton Interface

## Pin Description

**MAX5406**

PIN		NAME	FUNCTION
TSSOP	TQFN		
1	43	CBIAS	Bypass Capacitor Connection Point to Internally Generated Bias. Bypass CBIAS with a 50 $\mu$ F capacitor to system analog ground.
2	44	V <sub>SS</sub>	Negative Power-Supply Input. Bypass with a 0.1 $\mu$ F capacitor to system analog ground.
3	45	L1_H	Left-Channel 1 High Terminal Input. Connect the source between L1_H and L1_L for differential signals. Connect the source to L1_H and tie L1_L to BIAS for single-ended signals.
4	46	L1_L	Left-Channel 1 Low Terminal Input. Connect the source between L1_H and L1_L for differential signals. Connect L1_L to BIAS for single-ended signals.
5	47	L2_L	Left-Channel 2 Low Terminal Input. Connect the source between L2_H and L2_L for differential signals. Connect L2_L to BIAS for single-ended signals.
6	48	L2_H	Left-Channel 2 High Terminal Input. Connect the source between L2_H and L2_L for differential signals. Connect the source to L2_H and tie L2_L to BIAS for single-ended signals.
7	1	LMR	Left Minus Right Output Signal. LMR output provides a signal that is the difference of left and right input signals. See the <i>Ambience Control</i> section for more details.
8	2	AMBLI	Ambience Left-Channel Input. AMBLI provides the proper ambient effect at LOUT based on the transfer function implemented between LMR and AMBLI. See the <i>Ambience Control</i> section for more details.
9	3	CTL1	Left-Channel Treble Tone Control Capacitor Terminal 1. Connect a capacitor between CTL1 and CTL2 to set the treble cutoff frequency. See the <i>Tone Control</i> section for more details.
10	4	CTL2	Left-Channel Treble Tone Control Capacitor Terminal 2. Connect a capacitor between CTL2 and CTL1 to set the treble cutoff frequency. See the <i>Tone Control</i> section for more details.
11	5	CBL1	Left-Channel Bass Tone Control Capacitor Terminal 1. Connect a capacitor between CBL1 and CBL2 to set the bass cutoff frequency. See the <i>Tone Control</i> section for more details.
12	6	CBL2	Left-Channel Bass Tone Control Capacitor Terminal 2. Connect a capacitor between CBL2 and CBL1 to set the bass cutoff frequency. See the <i>Tone Control</i> section for more details.
13	7	LOUT	Left-Channel Output
14	8	CLSN	Subwoofer Left-Channel Highpass Filter Capacitor Negative Terminal. Connect a capacitor between CLSN and CLSP to set the highpass cutoff frequency at SUBOUT. See the <i>Subwoofer Output</i> section for more details.
15	9	CLSP	Subwoofer Left-Channel Highpass Filter Capacitor Positive Terminal. Connect a capacitor between CLSP and CLSN to set the highpass filter cutoff frequency at SUBOUT. See the <i>Subwoofer Output</i> section for more details.
16	10	SUBOUT	Subwoofer Output. Connect a capacitor from SUBOUT to CSUB to set the lowpass filter cutoff frequency at SUBOUT. See the <i>Subwoofer Output</i> section for more details.
17	11	CSUB	Subwoofer Lowpass Filter Capacitor Terminal. Connect a filter capacitor between CSUB and SUBOUT to set the lowpass filter cutoff frequency. See the <i>Subwoofer Output</i> section for more details.
18, 32	12, 26	I.C.	Internally Connected. Connect to DGND.

# Audio Processor with Pushbutton Interface

## Pin Description (continued)

PIN		NAME	FUNCTION
TSSOP	TQFN		
19	13	$\overline{\text{MUTE}}$	Active-Low Mute Control Input. Toggles state between muted and not muted. When in the mute state, all wipers are moved to the low end of the volume potentiometers. The last state is restored when $\overline{\text{MUTE}}$ is toggled again. The power-on state is not muted. $\overline{\text{MUTE}}$ is internally pulled up with 50k $\Omega$ to V <sub>LOGIC</sub> .
20	14	$\overline{\text{VOLDN}}$	Active-Low Downward Volume Control Input. Press $\overline{\text{VOLDN}}$ to decrease the volume. This simultaneously moves left and right volume wipers towards higher attenuation. $\overline{\text{VOLDN}}$ is internally pulled up with 50k $\Omega$ to V <sub>LOGIC</sub> .
21	15	$\overline{\text{VOLUP}}$	Active-Low Upward Volume Control Input. Press $\overline{\text{VOLUP}}$ to increase the volume. This simultaneously moves the left and right volume wipers towards the the lower attenuation. $\overline{\text{VOLUP}}$ is internally pulled up with 50k $\Omega$ to V <sub>LOGIC</sub> .
22	16	$\overline{\text{BALL}}$	Active-Low Left Balance Control Input. Press $\overline{\text{BALL}}$ to move the balance towards the left channel. $\overline{\text{BALL}}$ is internally pulled up with 50k $\Omega$ to V <sub>LOGIC</sub> .
23	17	$\overline{\text{BALR}}$	Active-Low Right Balance Control Input. Press $\overline{\text{BALR}}$ to move the balance towards the right channel. $\overline{\text{BALR}}$ is internally pulled up with 50k $\Omega$ to V <sub>LOGIC</sub> .
24	18	DGND	Digital Ground
25	19	V <sub>LOGIC</sub>	Digital Power-Supply Input. Bypass with 0.1 $\mu\text{F}$ to DGND.
26	20	$\overline{\text{SHDN}}$	Active-Low Shutdown Control Input. In shutdown mode, the MAX5406 stores every wiper's last position. Each wiper moves to the highest attenuation level of its corresponding potentiometer. Terminating shutdown mode restores every wiper to its previous setting. In shutdown, the MAX5406 does not acknowledge any pushbutton command.
27	21	$\overline{\text{BASSDN}}$	Active-Low Downward Bass Control Input. Press $\overline{\text{BASSDN}}$ to decrease bass boost. Bass boost emphasizes the signal's low-frequency components. $\overline{\text{BASSDN}}$ is internally pulled up with 50k $\Omega$ to V <sub>LOGIC</sub> . To implement a bass-boost button, connect $\overline{\text{BASSDN}}$ to BASSUP. Presses then toggle the state between flat and full bass boost on each button press.
28	22	$\overline{\text{BASSUP}}$	Active-Low Upward Bass Control Input. Press $\overline{\text{BASSUP}}$ to increase bass boost. Bass boost emphasizes the signal's low frequency components. $\overline{\text{BASSUP}}$ is internally pulled up with 50k $\Omega$ to V <sub>LOGIC</sub> . To implement a bass-boost button, connect $\overline{\text{BASSUP}}$ to $\overline{\text{BASSDN}}$ . Presses then toggle the state between flat and full bass boost on each button press.
29	23	$\overline{\text{TREBDN}}$	Active-Low Downward Treble Control Input. Press $\overline{\text{TREBDN}}$ to decrease the treble boost. Treble boost emphasizes the signal's high-frequency components. $\overline{\text{TREBDN}}$ is internally pulled up with 50k $\Omega$ to V <sub>LOGIC</sub> .
30	24	$\overline{\text{TREBUP}}$	Active-Low Upward Treble Control Input. Press $\overline{\text{TREBUP}}$ to increase the treble boost. Treble boost emphasizes the signal's high-frequency components. $\overline{\text{TREBUP}}$ is internally pulled up with 50k $\Omega$ to V <sub>LOGIC</sub> .
31	25	$\overline{\text{AMB}}$	Active-Low Ambience Switch Control Input. Drive $\overline{\text{AMB}}$ low to toggle on/off the ambience function. $\overline{\text{AMB}}$ is internally pulled up with 50k $\Omega$ to V <sub>LOGIC</sub> .
33	27	CRSN	Subwoofer Right-Channel Highpass Filter Capacitor Negative Terminal. Connect a capacitor between CRSN and CRSP to set the highpass cutoff frequency at SUBOUT. See the <i>Subwoofer Output</i> section for more details.
34	28	CRSP	Subwoofer Right-Channel Highpass Filter Capacitor Positive Terminal. Connect a capacitor between CRSP and CRSN to set the highpass cutoff frequency at SUBOUT. See the <i>Subwoofer Output</i> section for more details.
35	29	ROUT	Right-Channel Output

# Audio Processor with Pushbutton Interface

## Pin Description (continued)

**MAX5406**

PIN		NAME	FUNCTION
TSSOP	TQFN		
36	30	CBR2	Right-Channel Bass Tone Control Capacitor Terminal 2. Connect a nonpolarized capacitor between CBR2 and CBR1 to set the bass cutoff frequency. See the <i>Tone Control</i> section for more details.
37	31	CBR1	Right-Channel Bass Tone Control Capacitor Terminal 1. Connect a capacitor between CBR1 and CBR2 to set the bass cutoff frequency. See the <i>Tone Control</i> section for more detail.
38	32	CTR2	Right-Channel Treble Tone Control Capacitor Terminal 2. Connect a capacitor between CTR2 and CTR1 to set the treble cutoff frequency. See the <i>Tone Control</i> section for more details.
39	33	CTR1	Right-Channel Treble Tone Control Capacitor Terminal 1. Connect a capacitor between CTR1 and CTR2 to set the treble cutoff frequency. See the <i>Tone Control</i> section for more details.
40	34	AMBRI	Ambience Right-Channel Input. AMBRI provides the proper ambient effect at ROUT based on the gain between LPR and AMBRI. See the <i>Ambience Control</i> section for more details.
41	35	LPR	Left Plus Right Output Signal. LPR output provides a signal that is a combination of the left and right input signals. See the <i>Ambience Control</i> section for more details.
42	36	V <sub>DD</sub>	Positive Analog Supply Voltage. Bypass with a 0.1μF capacitor to system analog ground.
43	37	R2_H	Right-Channel High Terminal 2. Connect the source between R2_H and R2_L for differential signal. Connect the source to R2_H and tie R2_L to BIAS for single-ended signals.
44	38	R2_L	Right-Channel Low Terminal 2. Connect the source between R2_H and R2_L for differential signal. Connect R2_L to BIAS for single-ended signals.
45	39	R1_L	Right-Channel Low Terminal 1. Connect the source between R1_H and R1_L for differential signal. Connect R1_L to BIAS for single-ended signals.
46	40	R1_H	Right-Channel High Terminal 1. Connect the source between R1_H and R1_L for differential signal. Connect the source to R1_H and tie R1_L to BIAS for single-ended signals.
47	41	CMSNS	Common-Mode Voltage Sense. Connect to V <sub>DD</sub> to disable the internal bias generator and drive BIAS with external source to set output DC level.
48	42	BIAS	Internally Generated Bias Voltage. Connect CMSNS to V <sub>SS</sub> to enable the internally generated V <sub>BIAS</sub> . $V_{BIAS} = (V_{DD} + V_{SS}) / 2$ . Connect a 0.1μF capacitor between BIAS and system analog ground as close to the device as possible. Do not use BIAS to drive external circuitry.

# Audio Processor with Pushbutton Interface

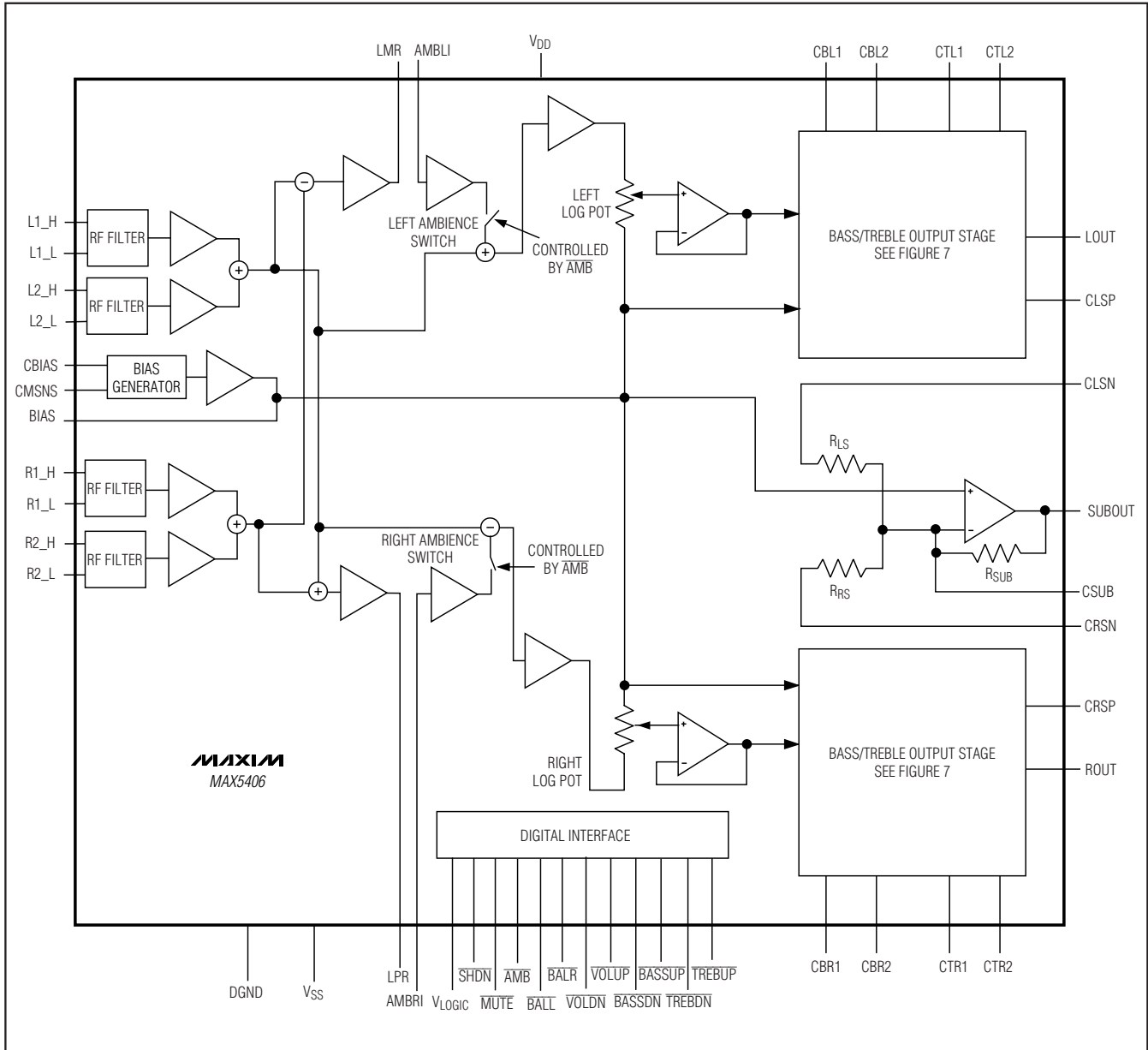

Figure 1. Block Diagram

## Detailed Description

The MAX5406 implements dual logarithmic potentiometers to control volume, dual potentiometers to control balance, and dual linear digital potentiometers to set the tone (Figure 1). A debounced pushbutton interface is provided to control the audio-processor settings. The MAX5406 provides differential buffered inputs with RF

filters to maximize noise reduction and a mixer to produce an equal amount of left and right input channels. In addition to a differential output, the MAX5406 provides a monophonic output at SUBOUT for systems with a subwoofer.

# Audio Processor with Pushbutton Interface

**Table 1. Wiper Action vs. Pushbutton Contact Duration**

CONTACT DURATION	WIPER ACTION
$t < t_{LPW}$	No motion (debouncing) (Figures 2a and 2b)
$t_{LPW} \leq t \leq 1s$	Wiper changes position once (Figures 2a and 2b)
$1s \leq t < 4s$	Wiper changes position at a rate of 4Hz (Figure 3)
$t \geq 4s$	Wiper changes position at a rate of 16Hz (Figure 3)

### Up/Down Interface

The MAX5406 features independent control inputs for volume, balance, ambience, and tone control. All control inputs are internally debounced for use with momentary contact SPST switches. All switch inputs are pulled up to  $V_{LOGIC}$  through 50k $\Omega$  resistors. The wiper setting advances once per button press held for up to 1s (see Figures 2a and 2b). Maxim's SmartWiper control circuitry allows the wiper to advance at a rate of 4Hz when an input is held low from 1s up to 4s, and at a rate of 16Hz if the contact is maintained for greater than 4s without the need of a  $\mu P$  (see Figure 3 and Table 1). The MAX5406 ignores multiple buttons being pressed. A  $\mu P$  can also be used to control the MAX5406.

### Volume Control

The MAX5406 implements dual logarithmic potentiometers for volume control that change the sound level by 2dB per button push (see Table 2).

In volume-control mode, the MAX5406's wipers move up and down together (see Figure 4). The balance is unaffected (see the *Balance Control* section). Left and right balance settings are maintained when adjusting the volume.

### Balance Control

In balance-control mode, the MAX5406 uses dual potentiometers to control balance for the left and right channels. Pressing BALR increases the right channel wiper by 1dB and decreases the left channel by 1dB. This causes the right channel to sound louder than the left channel by 2dB. The overall volume remains constant when adjusting the balance (Figure 5).

**Table 2. Attenuator Position For Volume Potentiometers**

POSITION	ATTENUATION (dB)
0	0
1	2
2	4
.....	.....
10 ( Power-on state)	20
.....	.....
30	60
31	62
32 (Mute)	> 90

### Volume and Balance Interaction

Volume and balance operation is simple. However, there are some interactions that occur at the extreme wiper positions. These interactions are described in this section of the data sheet.

When the volume setting is at the maximum level, the first command to move the balance toward the left channel forces the right channel to decrease by 1dB. Subsequent pressing of BALL causes the right channel to decrease by 2dB. At this position, shown in the right column of Figure 6a, the left-channel volume is maximum, but the actual separation between L and R is 3dB.

At this position, pressing  $\overline{VOLDN}$  restores the actual balance setting only after  $\overline{VOLDN}$  is pressed at least half as many times as BALL was (previously) pressed (shown in the middle and right column of Figure 6b) to increase the right-channel balance.

The volume and balance interaction is similar when volume setting is at the minimum level.

### Tone Control

The MAX5406 implements a linear potentiometer to control the bass and treble over a range of  $\pm 10$ dB using the recommended component values.

Note that the actual response achieved is determined by the values of both external and internal components and the design equations are somewhat interactive.

Use the values shown in the *Electrical Characteristics* as a good starting point for choosing component values. These components yield shelf turnovers at 100Hz (bass) and 10kHz (treble) with a total  $\pm 10$ dB of boost at 100Hz and 10kHz. The shoulder or flat portion of the response is centered on 1kHz.

The circuit in Figure 7 shows the internal structure of the tone-control system should modification to the

# Audio Processor with Pushbutton Interface

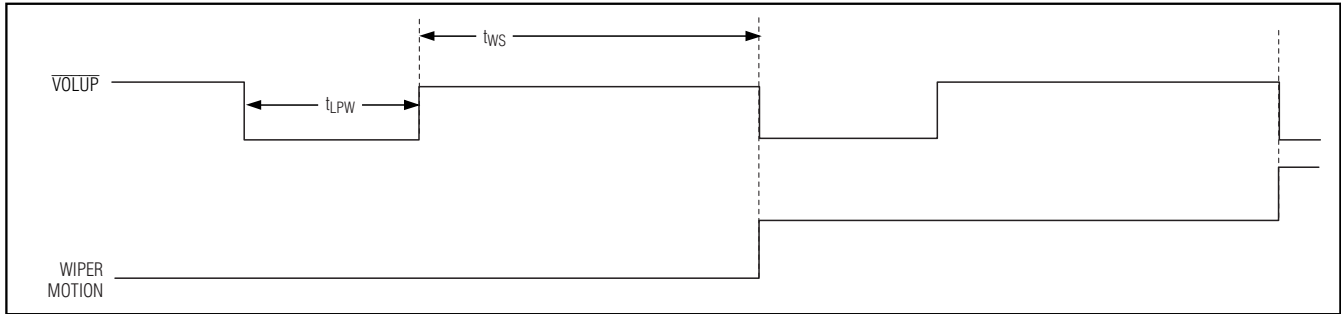

Figure 2a. Single-Pulse Input

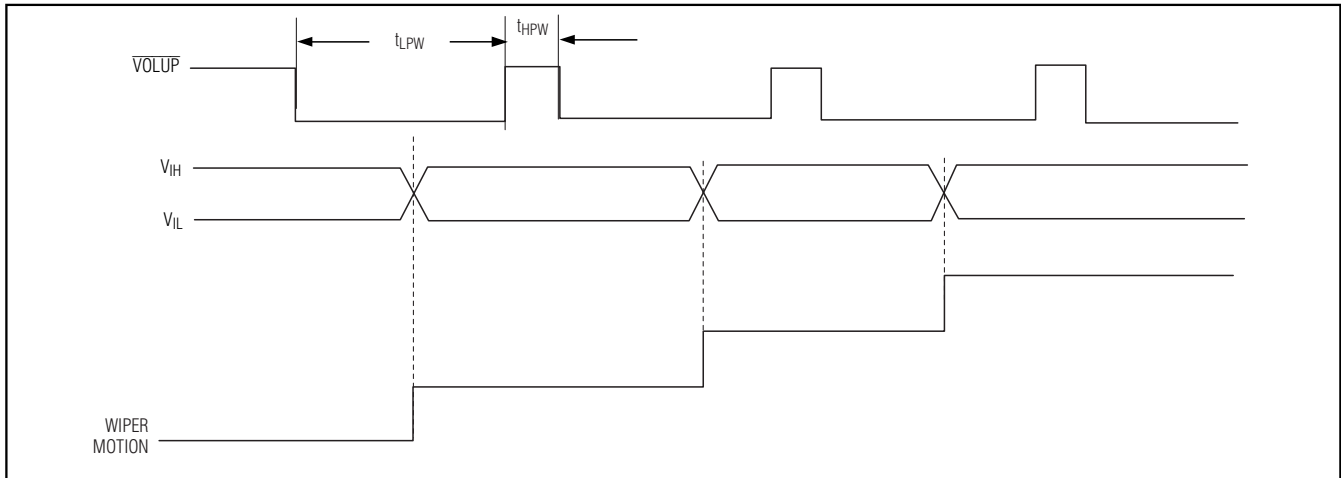

Figure 2b. Repetitive Input-Pulse Separation Time

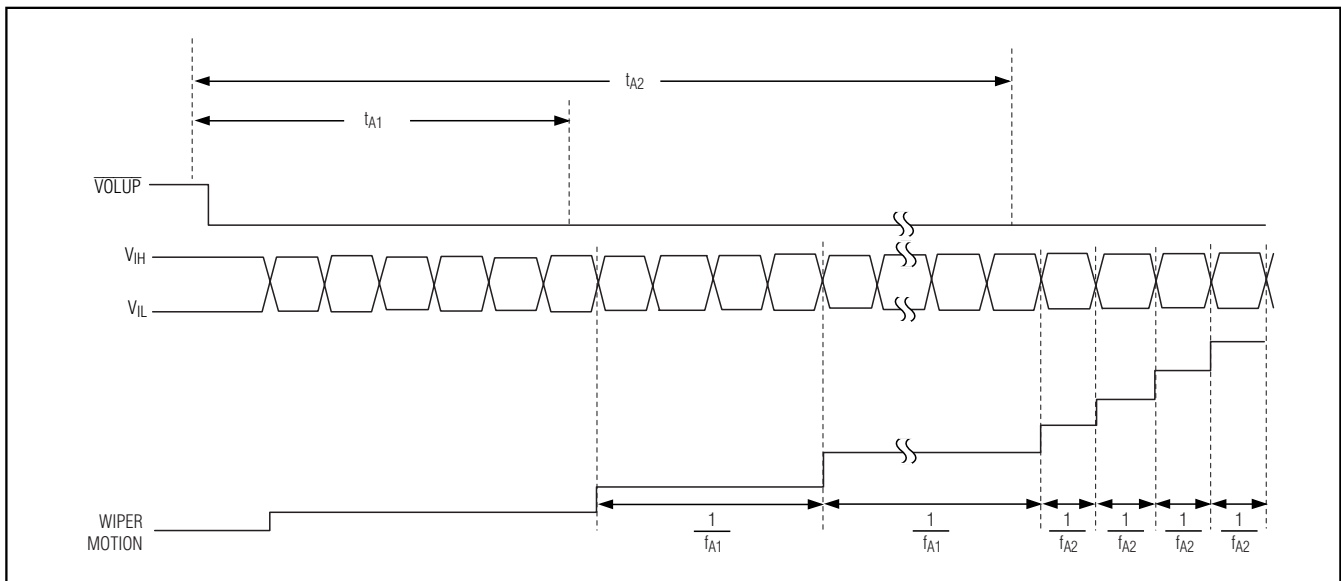

Figure 3. Accelerated Wiper Motion



# Audio Processor with Pushbutton Interface

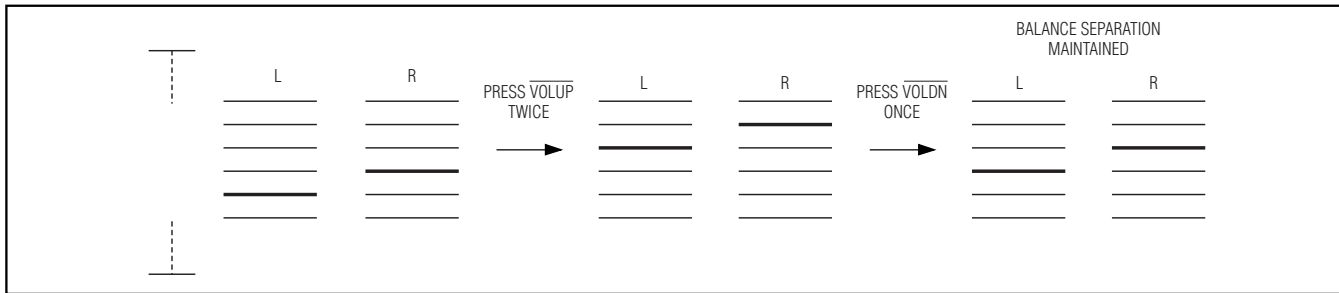

Figure 4. Basic Volume-Control Operation

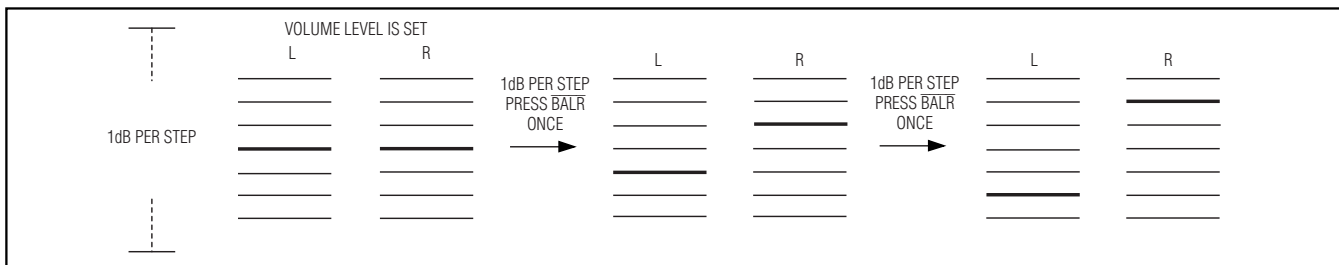

Figure 5. Basic Balance-Control Operation

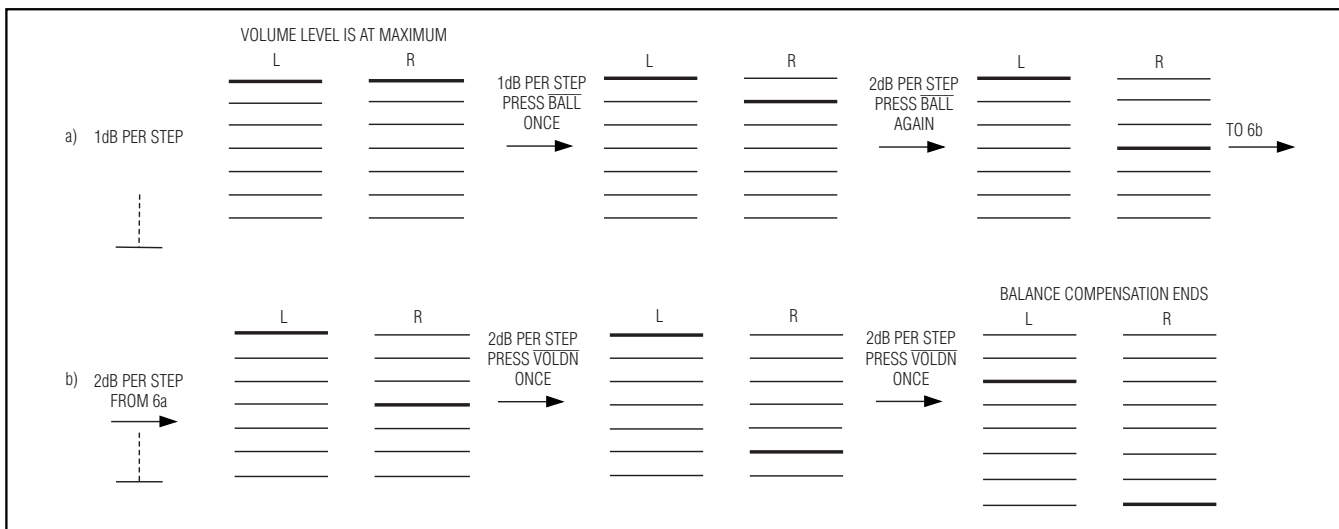

Figure 6. Volume and Balance Interaction

response curve be desired. A combination of internal resistors and external capacitors determine the response of the circuit.

Use the following equations to calculate the external capacitor values for the desired 3dB frequencies:

$$f_{\text{BASS}(3\text{dB})} = \frac{1}{2\pi \times R_{\text{BPOT}} \times C_{\text{B}_-}}$$

where  $R_{\text{BPOT}}$ , nominally  $116\text{k}\Omega$ , is the bass potentiometer (see Figure 7).

$$f_{\text{TREBLE}(3\text{dB})} = \frac{1}{2\pi \times R_{\text{T}} \times C_{\text{T}_-}}$$

where  $R_{\text{T}}$  is nominally  $3.5\text{k}\Omega$  (see Figure 7).

# Audio Processor with Pushbutton Interface

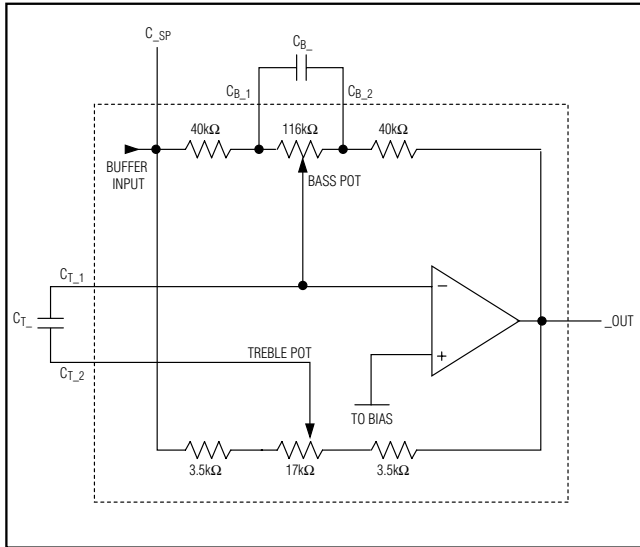

Figure 7. Bass/Treble Output Stage

Alternatively, the following formulas can be used to calculate and design for the bass and treble turn-over frequencies:

$$f_{\text{BASS(TURNOVER)}} = \frac{1}{2\pi \times R_B \times C_{B\_}}$$

where  $R_B$  is nominally  $40k\Omega$  (see Figure 7).

$$f_{\text{TREBLE(TURNOVER)}} = \frac{1}{2\pi \times (R_T + R_B) \times C_{T\_}}$$

Tables 3 and 4 show the effects of the external bass and treble capacitance on the maximum output attenuation.

**Table 3. Effect of Base Tone Control Capacitor ( $C_{B\_}$ ) on Bass Boost/Bass Cut at 100Hz**

$C_{B\_}$ (nF)	CUT (dB)	BOOST (dB)
0.00	-11.79	11.81
0.47	-11.25	11.26
1.80	-11.05	11.08
2.20	-10.95	10.96
2.70	-10.85	10.86
3.30	-10.60	10.62
4.70	-10.57	10.55
6.80	-10.10	10.15
8.20	-9.66	9.66

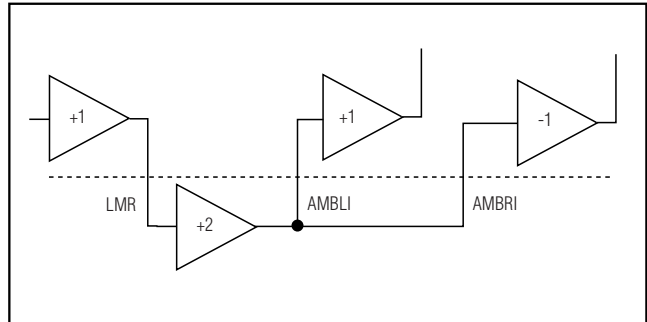

Figure 8. Matrix Surround Configuration

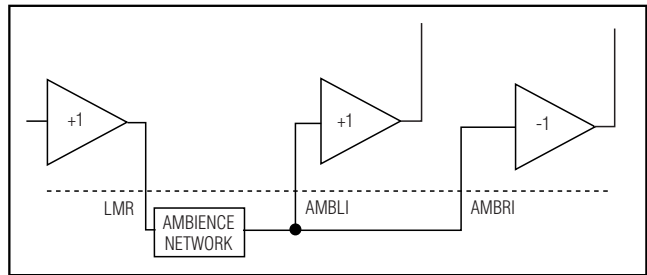

Figure 9. Ambience Filter

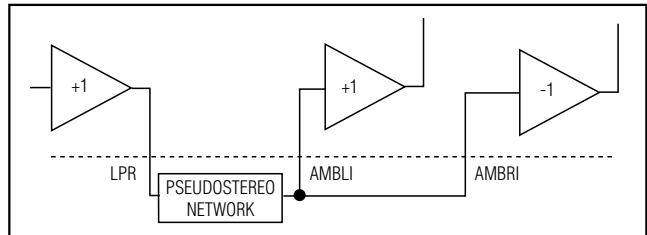

Figure 10. Pseudostereo Filter

**Table 4. Effect of Treble Tone Control Capacitor ( $C_{T\_}$ ) on Treble Boost/Treble Cut at 10kHz**

$C_{T\_}$ (nF)	CUT (dB)	BOOST (dB)
0.47	-7.80	7.66
1.80	-12.55	12.58
2.20	-12.89	12.95
2.70	-13.15	13.18
3.30	-13.33	13.34
4.70	-13.55	13.58
6.80	-13.59	13.61
8.20	-13.61	13.63
Open	-13.79	13.75



# Audio Processor with Pushbutton Interface

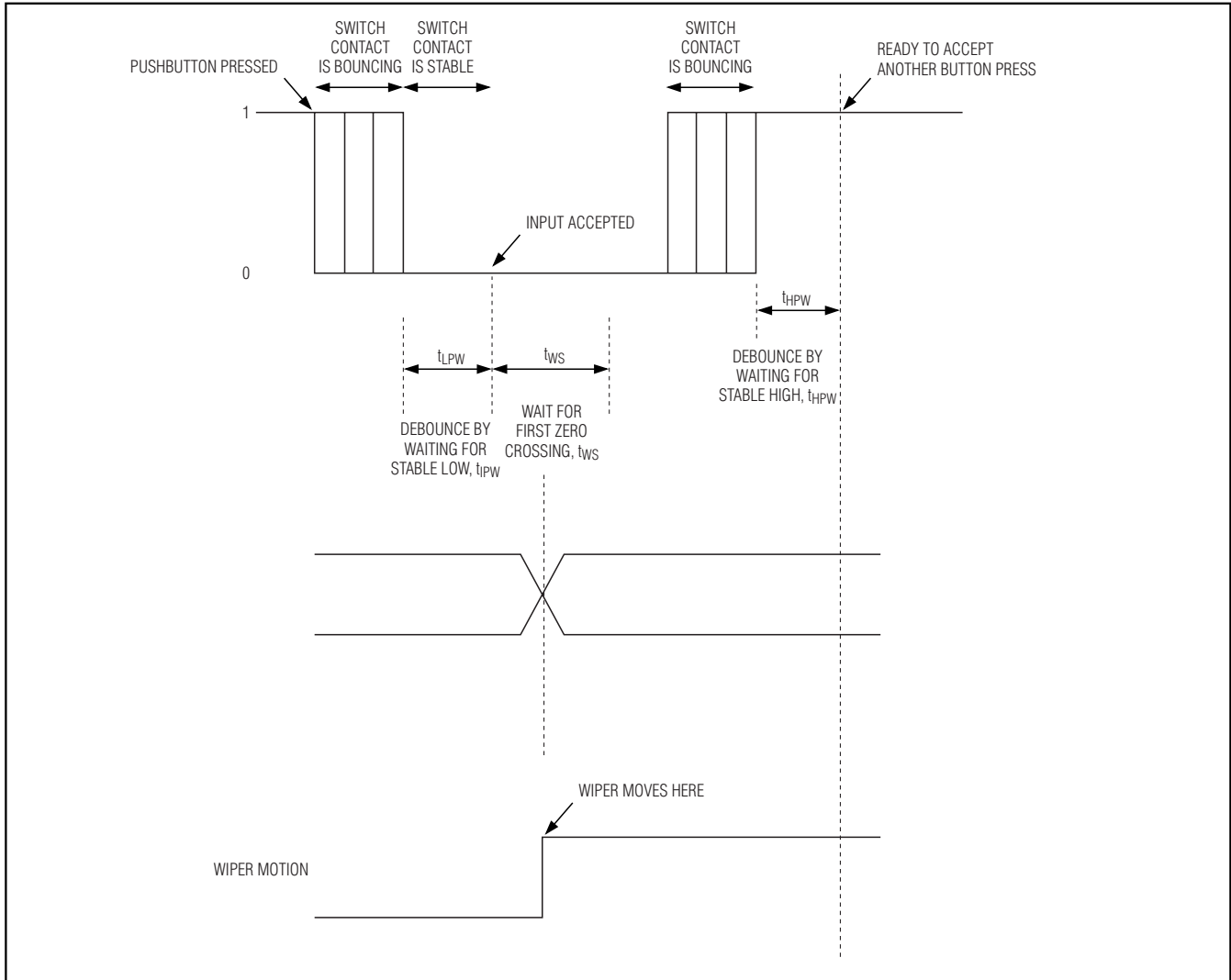

Figure 11b. Wiper Transition Timing Diagram (Zero Crossing Detected)

$$L_{OUT} = L_{IN} + F_L(S) \times \frac{(L_{IN} - R_{IN})}{4}$$

$$R_{OUT} = R_{IN} - F_R(S) \times \frac{(L_{IN} - R_{IN})}{4}$$

$$L_{OUT} = \frac{3}{2}L_{IN} - \frac{1}{2}R_{IN}$$

$$R_{OUT} = \frac{3}{2}R_{IN} - \frac{1}{2}L_{IN}$$

where  $\left(\frac{L_{IN} - R_{IN}}{4}\right)$  is the signal at LMR.

When  $F_L(S)$  and  $F_R(S) = 2$  (LMR, AMBLI, and AMBRI are connected with the multiplier network of Figure 8), the equations become:

Use a passive filter network as shown in Figure 9 to filter and delay the LMR signal in more advanced applications.

# Audio Processor with Pushbutton Interface

## Pseudostereo

Pseudostereo creates a sound approximating stereo from a monophonic signal. Use the equations for pseudostereo response calculations:

$$L_{OUT} = L_{IN} + F_{L(S)} \times \frac{(L_{IN} + R_{IN})}{4}$$

$$R_{OUT} = R_{IN} - F_{R(S)} \times \frac{(L_{IN} + R_{IN})}{4}$$

where  $\left(\frac{L_{IN} + R_{IN}}{4}\right)$  are the signals at LPR.

Connect a pseudostereo network ( $F_{L(S)}$  and  $F_{R(S)}$ ) as shown in Figure 10 to filter and delay the LPR signal and create the pseudo signal.

## Click/Pop Suppression

The click/pop suppression feature reduces the audible noise (clicks and pops) that results from wiper transitions. The MAX5406 minimizes this noise by allowing the wiper position changes only when the potential across the pot is zero. Thus, the wiper changes position only when the voltage at  $L_-$  is the same as the voltage at the corresponding  $H_-$ . Each wiper has its own suppression and timeout circuitry (see Figure 11a). The MAX5406 changes wiper position after 32ms or when high = low, whichever occurs first (see Figure 11b).

## Power-On Reset

The MAX5406 initiates power-on reset when  $V_{LOGIC}$  falls below 2.2V and returns to normal operation when  $V_{LOGIC} = +2.7V$ . A power-on reset places the volume in the mute (-90dB) state and volume wipers gradually move to -20dB over a period of 0.7s in 2dB steps if no zero-crossing event is detected. All other controls remain in the 0dB position.

## Shutdown ( $\overline{SHDN}$ )

The MAX5406 stores the current wiper setting of each potentiometer in shutdown mode. The wipers move to the mute position to minimize the signal out of  $L_{OUT}$  and  $R_{OUT}$ . Returning from shutdown mode restores all wipers to their previous settings. Button presses in shutdown are ignored.

## Mute Function ( $\overline{MUTE}$ )

The MAX5406 features a mute function that sets the volume typically 90dB attenuation relative to full scale. Successive pulses on  $\overline{MUTE}$  toggle its setting. Activating the mute function forces all wipers to the low side of the potentiometer chain. Deactivating the mute function returns the wipers to their previous settings.

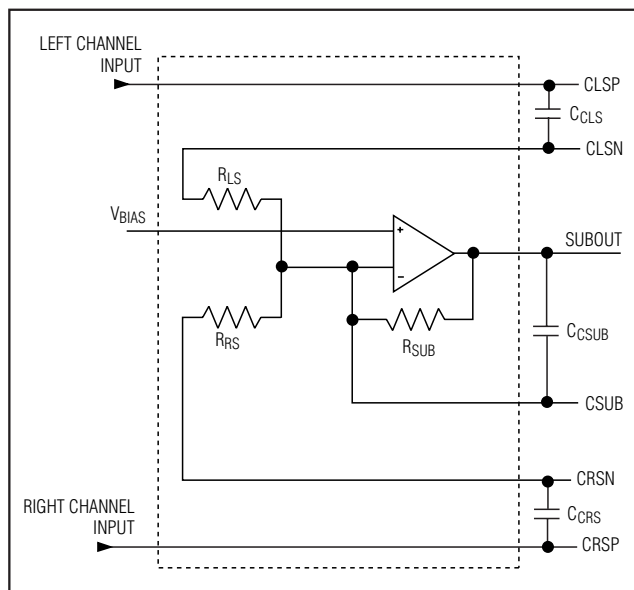

Figure 12. Subwoofer Output Stage

$\overline{MUTE}$  is internally pulled high with a 50k $\Omega$  resistor to  $V_{LOGIC}$ .

## Multiple Button Pushes

The MAX5406 ignores simultaneous presses of two or more buttons. Pushing more than one button at the same time does not change the state of the wipers. Additionally, further key presses are ignored for 50ms after all keys have been released. The MAX5406 does not respond to any logic input until the blocking period ends.

## Bias Generator

The MAX5406 generates a midrail,  $(V_{DD} + V_{SS}) / 2$  bias voltage, for use with the input amplifiers.

For normal single-supply operation and single-ended signals, connect  $R1\_L$ ,  $L1\_L$ ,  $R2\_L$ , and  $L2\_L$  to  $V_{BIAS}$  and  $V_{SS}$  to ground.

Enable the  $V_{BIAS}$  generator by connecting  $CMSNS$  to  $V_{SS}$  or leave  $CMSNS$  unconnected. Disable the  $V_{BIAS}$  generator by forcing  $CMSNS$  to  $V_{DD}$ . For proper operation, do not use  $V_{BIAS}$  to power other circuitry.

# Audio Processor with Pushbutton Interface

## Subwoofer Output

The subwoofer output of the MAX5406 combines and filters the left and right inputs for output to a subwoofer. Choose the capacitor values to set the bandpass filter to frequencies between 15Hz and 100Hz.

Figure 12 shows the subwoofer output stage configuration. The subwoofer output is a monophonic signal produced by adding the left and the right input signals. The amplifier of the subwoofer output stage produces a bandpass response. Use the following formulas to determine the cutoff frequencies for the bandpass filter:

$$f_{\text{HIGHPASS}} = \frac{1}{2 \times \pi \times R_{\text{S}} \times C_{\text{C}_\text{S}}}$$

$$f_{\text{LOWPASS}} = \frac{1}{2 \times \pi \times R_{\text{CSUB}} \times C_{\text{CSUB}}}$$

where  $R_{\text{S}}$  is  $R_{\text{LS}}$  or  $R_{\text{RS}}$  and has the nominal value of 13.8k $\Omega$ ,  $R_{\text{CSUB}}$  has the nominal value of 10.6k $\Omega$ , and  $C_{\text{C}_\text{S}}$  is  $C_{\text{CLS}}$  or  $C_{\text{CRS}}$ . The external capacitors are as shown in Figure 12.

## Applications Information

### Bass Boost

Some simple products may not need a variable bass tone control. It may be desirable for such products to have a bass-boost pushbutton. Tie  $\overline{\text{BASSUP}}$  and  $\overline{\text{BASSDN}}$  together to provide a bass-boost feature. When tied together, the bass boost is toggled between 0dB and maximum by pressing  $\overline{\text{BASSUP}}$  or  $\overline{\text{BASSDN}}$ .

### Unequal Source Levels

Audio sources input to the MAX5406 may not have the same full-scale voltage swings. Use a resistor in series with the higher voltage swing input source to reduce the gain for that input.

For example, to reduce the gain by half, add a 10k $\Omega$  resistor in series with  $L1_{\text{H}}$  and  $R1_{\text{H}}$ , and a 20k $\Omega$  in series with  $L1_{\text{L}}$  and  $R1_{\text{L}}$ .

## Chip Information

PROCESS: BiCMOS

# Audio Processor with Pushbutton Interface

## Pin Configurations

**MAX5406**

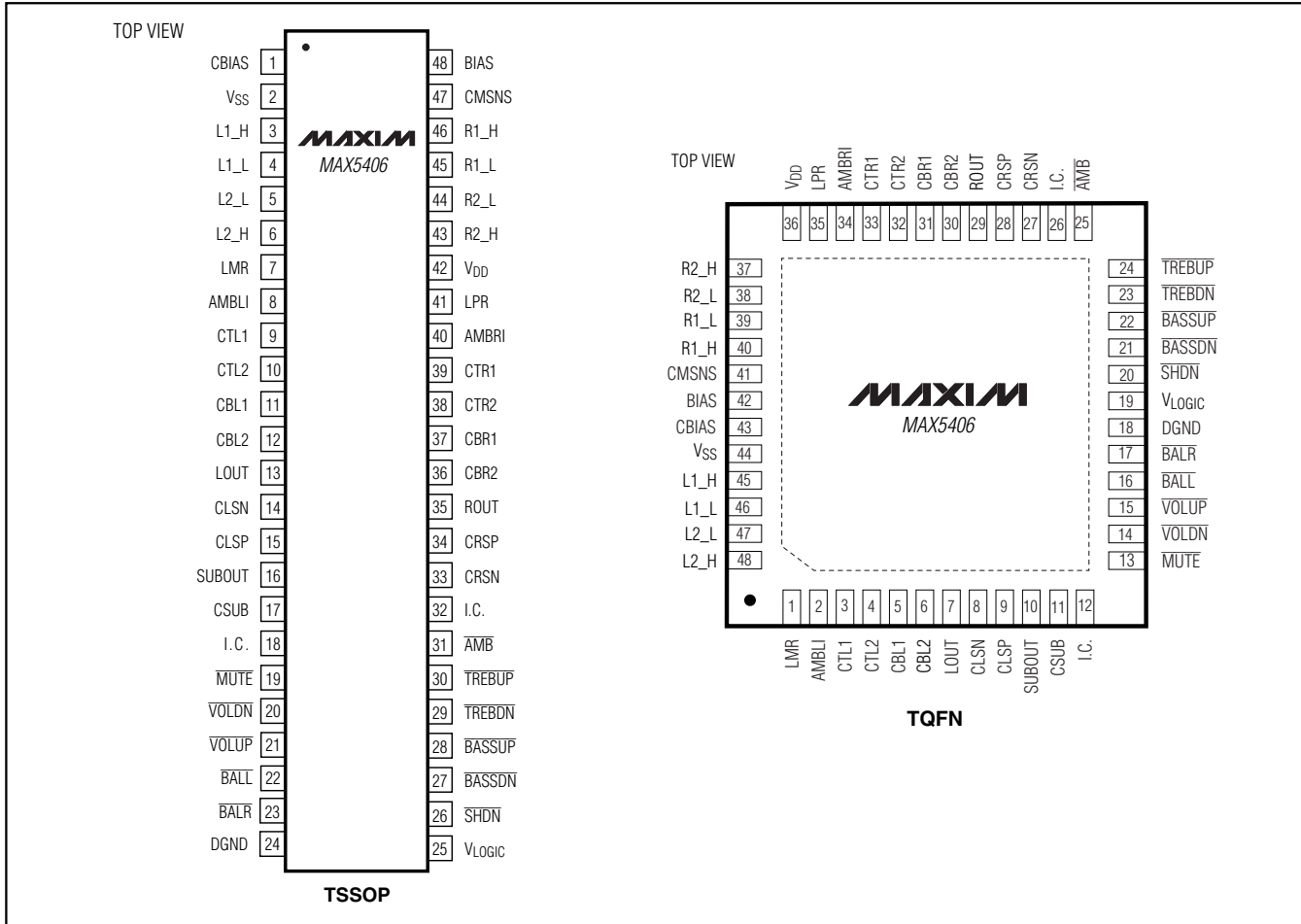

# Audio Processor with Pushbutton Interface

## Typical Application Circuit

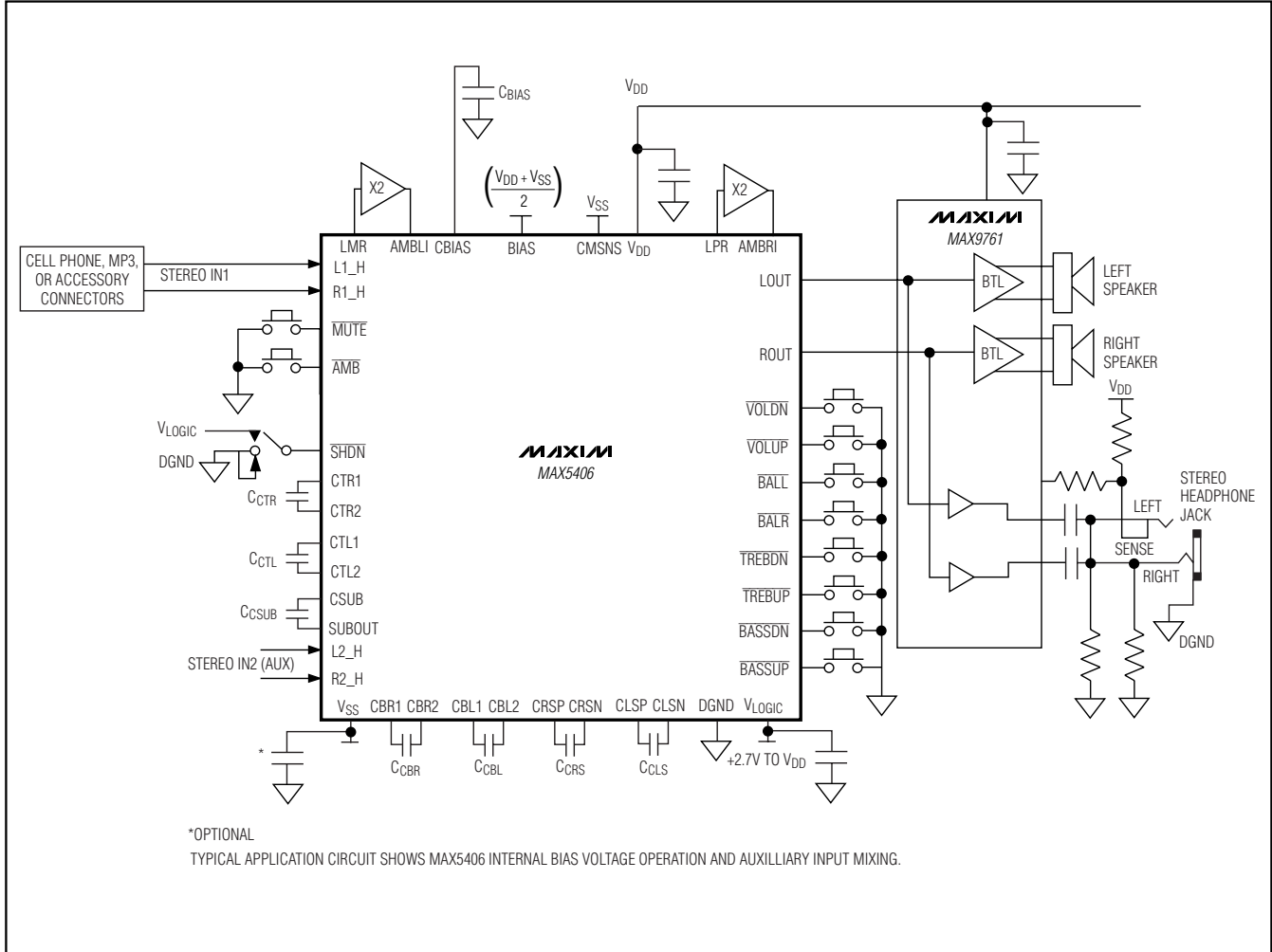



# Audio Processor with Pushbutton Interface

## Package Information

(The package drawing(s) in this data sheet may not reflect the most current specifications. For the latest package outline information, go to [www.maxim-ic.com/packages](http://www.maxim-ic.com/packages).)

MAX5406

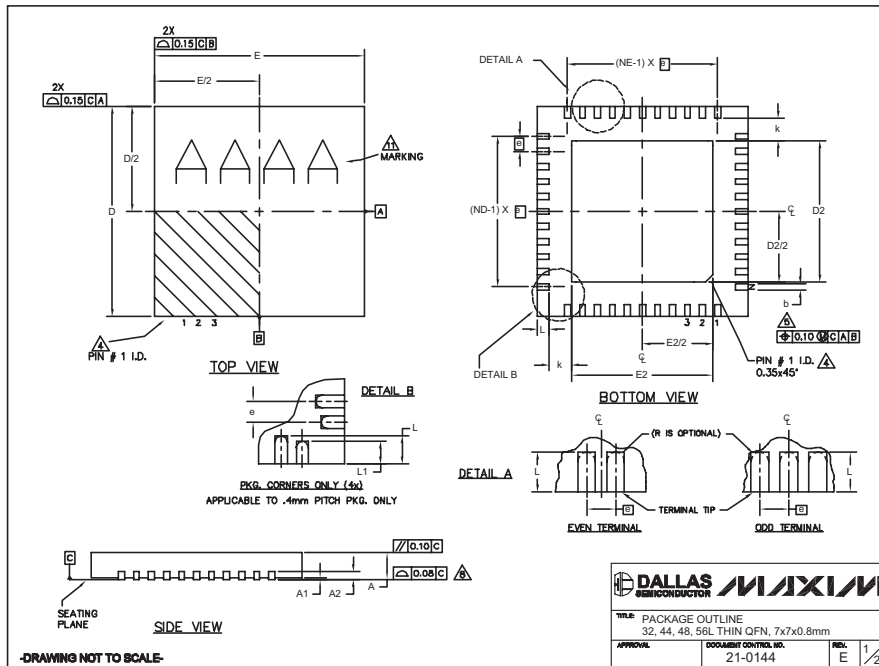

32, 44, 48L QFN.EPS

COMMON DIMENSIONS																
PKG	32L 7x7			44L 7x7			48L 7x7			CUSTOM PKG. (T4877-1) 48L 7x7			56L 7x7			
	SYMBOL	MIN.	NOM.	MAX.	MIN.	NOM.	MAX.	MIN.	NOM.	MAX.	MIN.	NOM.	MAX.	MIN.	NOM.	MAX.
A	0.70	0.75	0.80	0.70	0.75	0.80	0.70	0.75	0.80	0.70	0.75	0.80	0.70	0.75	0.80	0.80
A1	0	0.02	0.05	0	0.02	0.05	0	0.02	0.05	0	0.02	0.05	0	0.02	0.05	0
A2	0.20	REF.		0.20	REF.		0.20	REF.		0.20	REF.		0.20	REF.		0.20
b	0.25	0.30	0.35	0.20	0.25	0.30	0.20	0.25	0.30	0.20	0.25	0.30	0.20	0.25	0.30	0.15
D	6.90	7.00	7.10	6.90	7.00	7.10	6.90	7.00	7.10	6.90	7.00	7.10	6.90	7.00	7.10	6.90
E	6.90	7.00	7.10	6.90	7.00	7.10	6.90	7.00	7.10	6.90	7.00	7.10	6.90	7.00	7.10	6.90
e	0.85 BSC.			0.50 BSC.			0.50 BSC.			0.50 BSC.			0.40 BSC.			
k	0.25	-	-	0.25	-	-	0.25	-	-	0.25	-	-	0.25	0.35	0.45	
L	0.45	0.55	0.65	0.45	0.55	0.65	0.30	0.40	0.50	0.45	0.50	0.65	0.40	0.50	0.60	
L1	-	-	-	-	-	-	-	-	-	-	-	-	0.30	0.40	0.50	
N	32			44			48			44			56			
ND	8			11			12			10			14			
NE	8			11			12			12			14			

EXPOSED PAD VARIATIONS										
PKG. CODES	DEPOPULATED LEADS	D2			E2			JEDEC MO220 REV. C	DOWN BONDS ALLOWED	
		MIN.	NOM.	MAX.	MIN.	NOM.	MAX.			
T3277-2	-	4.55	4.70	4.85	4.60	4.70	4.85	-	YES	
T3277-3	-	4.55	4.70	4.85	4.55	4.70	4.85	-	NO	
T4477-2	-	4.55	4.70	4.85	4.55	4.70	4.85	WKD-1	YES	
T4477-3	-	4.85	4.70	4.85	4.60	4.70	4.85	WKD-1	YES	
T4877-1*	13,24,37,48	4.20	4.30	4.40	4.20	4.30	4.40	-	NO	
T4877-3	-	4.95	5.10	5.25	4.95	5.10	5.25	-	YES	
T4877-4	-	5.45	5.60	5.63	5.45	5.60	5.63	-	YES	
T4877-5	-	2.40	2.50	2.60	2.40	2.50	2.60	-	NO	
T4877-6	-	5.45	5.60	5.63	5.45	5.60	5.63	-	NO	
T4877-7	-	4.95	5.10	5.25	4.95	5.10	5.25	-	YES	
T5677-1	-	5.20	5.30	5.40	5.20	5.30	5.40	-	YES	

\*\* NOTE: T4877-1 IS A CUSTOM 48L PKG. WITH 4 LEADS DEPOPULATED. TOTAL NUMBER OF LEADS ARE 44.

**DALLAS MAXIM SEMICONDUCTOR**  
 TITLE: PACKAGE OUTLINE  
 32, 44, 48, 56L THIN QFN, 7x7x0.8mm  
 APPROVAL: 21-0144 REV. E 2/2

- NOTES:
1. DIMENSIONING & TOLERANCING CONFORM TO ASME Y14.5M-1994.
  2. ALL DIMENSIONS ARE IN MILLIMETERS. ANGLES ARE IN DEGREES.
  3. N IS THE TOTAL NUMBER OF TERMINALS.
  4. THE TERMINAL #1 IDENTIFIER AND TERMINAL NUMBERING CONVENTION SHALL CONFORM TO JEDEC 95-1 SPP-012. DETAILS OF TERMINAL #1 IDENTIFIER ARE OPTIONAL, BUT MUST BE LOCATED WITHIN THE ZONE INDICATED. THE TERMINAL #1 IDENTIFIER MAY BE EITHER A MOLD OR MARKED FEATURE.
  5. DIMENSION b APPLIES TO METALLIZED TERMINAL AND IS MEASURED BETWEEN 0.25 mm AND 0.30 mm FROM TERMINAL TIP.
  6. ND AND NE REFER TO THE NUMBER OF TERMINALS ON EACH D AND E SIDE RESPECTIVELY.
  7. DEPOPULATION IS POSSIBLE IN A SYMMETRICAL FASHION.
  8. COPLANARITY APPLIES TO THE EXPOSED HEAT SINK SLUG AS WELL AS THE TERMINALS.
  9. DRAWING CONFORMS TO JEDEC MO220 EXCEPT THE EXPOSED PAD DIMENSIONS OF T4877-1/-3/-4/-5/-6 & T5677-1.
  10. WARPAGE SHALL NOT EXCEED 0.10 mm.
  11. MARKING IS FOR PACKAGE ORIENTATION REFERENCE ONLY.
  12. NUMBER OF LEADS SHOWN ARE FOR REFERENCE ONLY.

# Audio Processor with Pushbutton Interface

## Package Information (continued)

(The package drawing(s) in this data sheet may not reflect the most current specifications. For the latest package outline information, go to [www.maxim-ic.com/packages](http://www.maxim-ic.com/packages).)

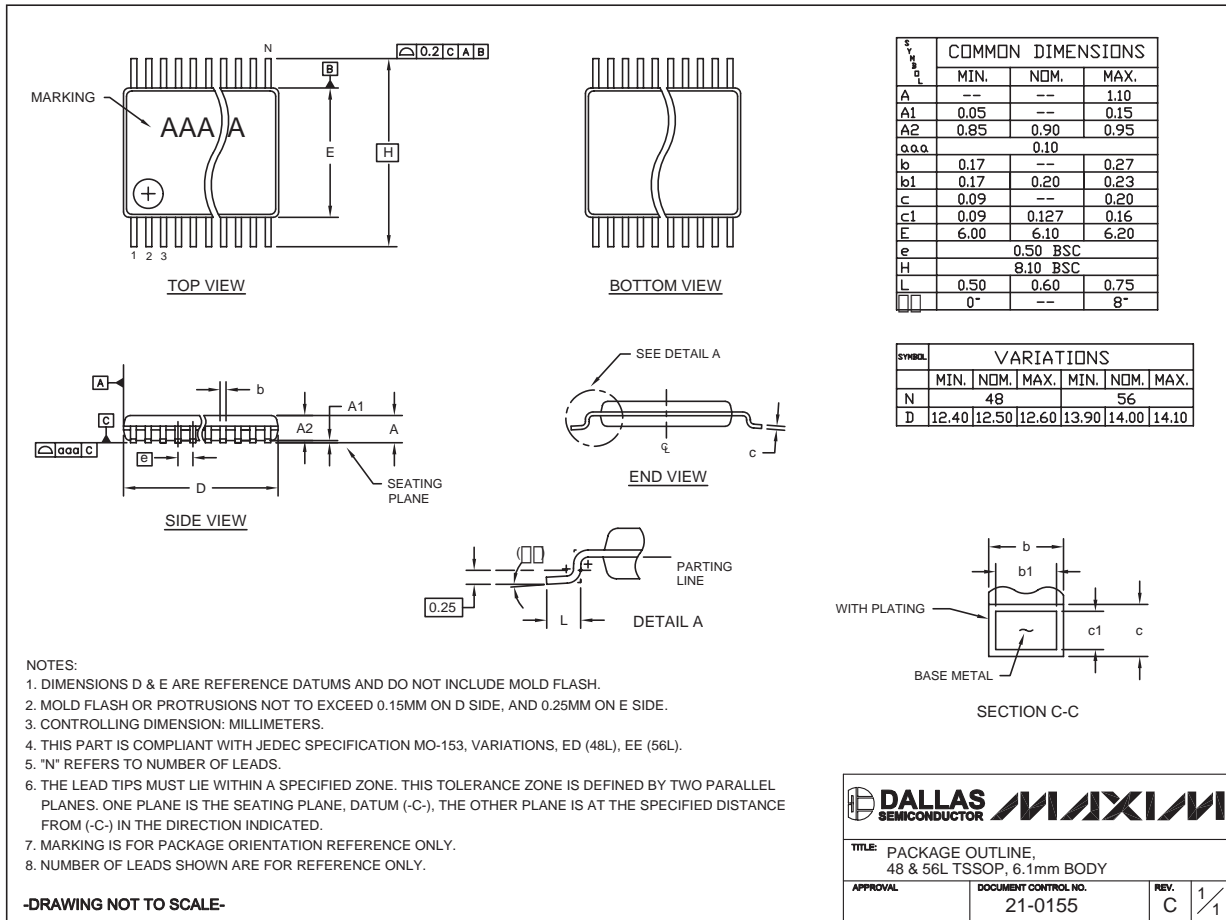

48L TSSOP-EPS

Maxim cannot assume responsibility for use of any circuitry other than circuitry entirely embodied in a Maxim product. No circuit patent licenses are implied. Maxim reserves the right to change the circuitry and specifications without notice at any time.

26 **Maxim Integrated Products, 120 San Gabriel Drive, Sunnyvale, CA 94086 408-737-7600**