

LG - 207

The LG - 207 photointerrupter combine high output GaAs IRED with photo IC.

The sensor makes possible easy development of objectdetecting systems with high performance, high reliability and small equipment size.

FEATURES

- Compatible to TTL and LSTTL
- Built in Amplifier and Schmitt Trigger
- Wide Vcc range

APPLICATIONS

- Floppy disk drives
- Copiers
- Facsimiles
- Paper sensors

DIMENSIONS

(Unit : mm)

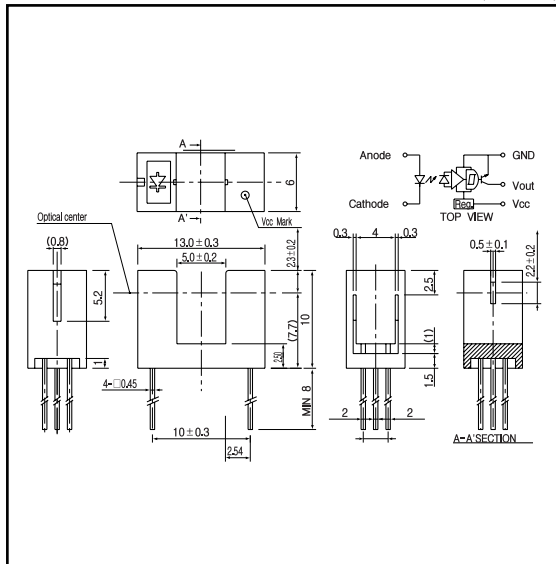

MAXIMUM RATINGS

(Ta=25)

Item	Symbol	Rating	Unit	
Input	Power dissipation	P _o	100	mW
	Reverse voltage	V _R	5	V
	Forward current	I _F	60	mA
Output	Supply voltage	V _{CC}	16	V
	Low level output current	I _{OL}	30	mA
	Power dissipation	P	200	mW
Operating temp.		Topr.	- 20 ~ + 85	
Storage temp.		Tstg.	- 30 ~ + 85	
Soldering temp.*1		Tsol.	240	

*1. For MAX. 5 seconds at the position of 1mm from the package

ELECTRO-OPTICAL CHARACTERISTICS

(Ta=25)

Item	Symbol	Conditions	Min.	Typ.	Max.	Unit.
Input	Forward voltage	I _F =60mA		1.3	1.6	V
	Reverse current	V _R =5V			10	μA
	Capacitance	V=0V, f=1MHz		25		pF
Output	Operating supply voltage range		4.5		16	V
	Low level output voltage	I _{OL} =16mA, V _{CC} =5V, I _F =0			0.4	V
	High level output voltage*2	I _F =10mA, V _{CC} =5V, R _L =10K	4			V
	Low level supply current	V _{CC} =5V, I _F =0		2	7	mA
	High level supply current	V _{CC} =5V, I _F =10mA		2	7	mA
Trans - mission	L _F H threshold input current	V _{CC} =5V		6		mA
	Hysteresis	V _{CC} =5V		0.75		-
	L _F H propagation time*3	V _{CC} =5V, I _F =10mA		2		μsec.
	H _F L propagation time*3	R _L =280		1		

*2,*3. refer to measurement diagram as right side.

Photointerrupters(Transmissive)

LG - 207

Power dissipation Vs. Ambient temperature

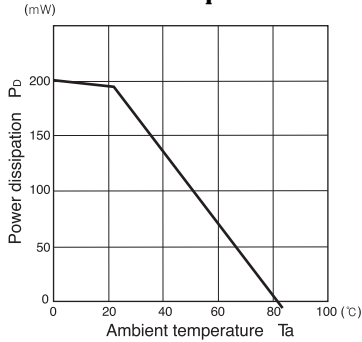

Forward current Vs. Forward voltage

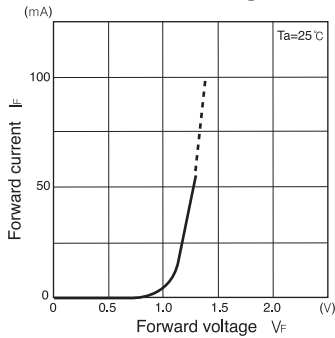

Low level output voltage Vs. Low level output current

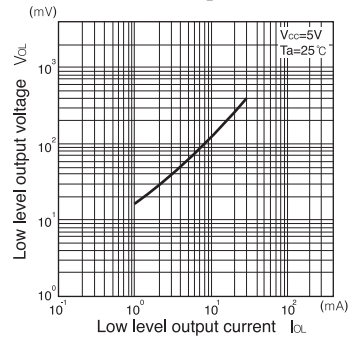

Relative threshold input current Vs. Supply voltage

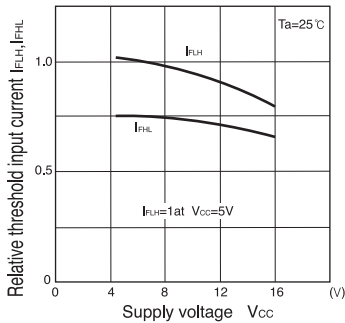

Relative threshold input current Vs. Ambient temperature

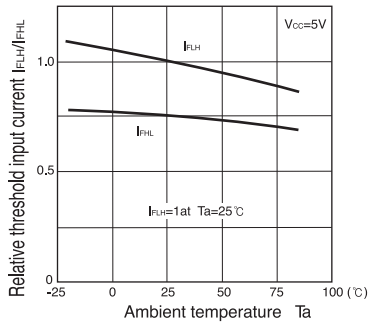

Measurement of high level output voltage

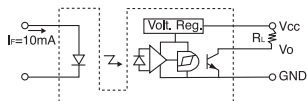

Measurement of propagation time

