



AUDIO PROCESSOR

■GENERAL DESCRIPTION

The NJW1142A is a sound processor includes all of the functions required to process the audio signal for TV, such as tone control, balance, volume, mute, and AGC functions.

Also the NJW1142A performs NJRC Surround "eala" which is regenerated 3D surround sound with only two speakers.

All of the internal status and variables are controlled by I²C BUS interface.

■ PACKAGE OUTLINE



NJW1142AV

■FEATURES

- Operating Voltage 8 to 10V
- Internal 4 Input Audio Selectors and Monitor Output
- Low Noise VCA
- NJRC Surround "eala"
- Simulated Stereo
- Variable AGC Compression Level via I²C (4-levels)
- Bi-CMOS Technology
- Package Outline SSOP32

■BLOCK DIAGRAM

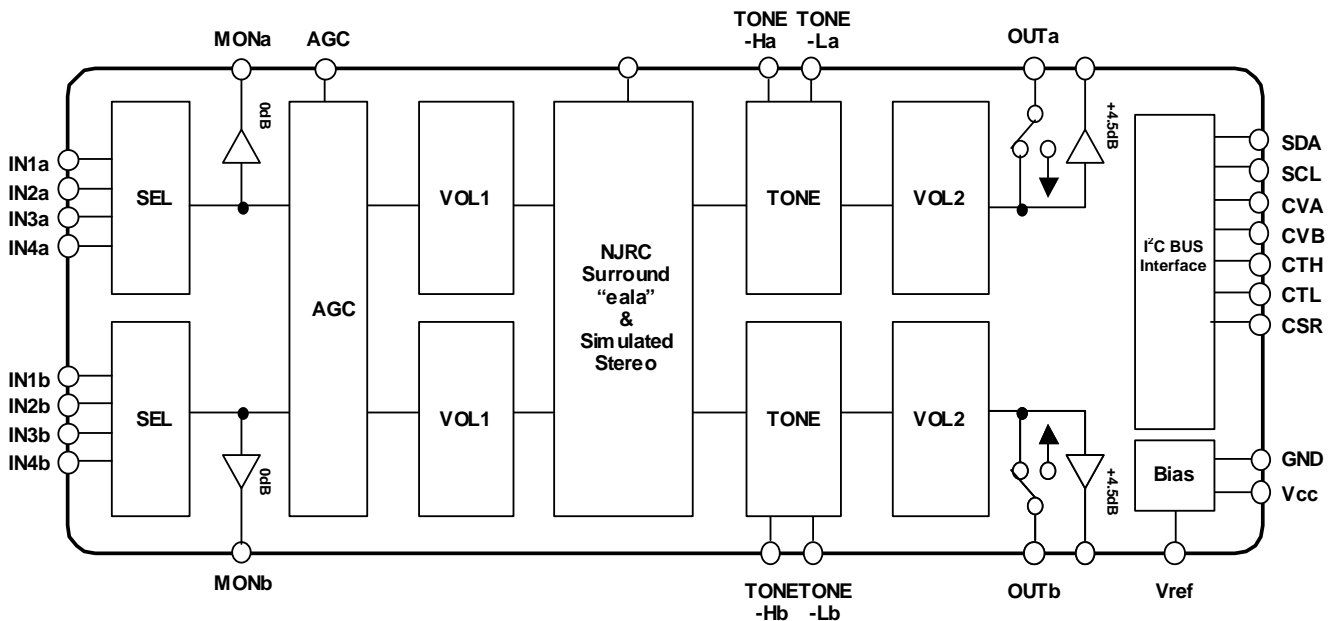

■PIN CONFIGURATION

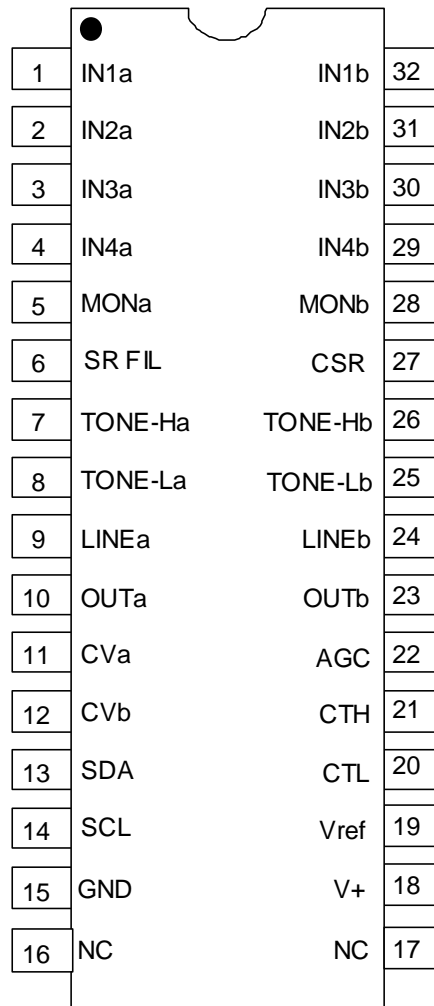

No.	Symbol	Function	Symbol	Function	
1	IN1a	Ach Input 1	17	NC	No Connect
2	IN2a	Ach Input 2	18	V+	Power Supply Terminal
3	IN3a	Ach Input 3	19	Vref	Reference Voltage
4	IN4a	Ach Input 4	20	CTL	Pop Noise reduction for Bass Control
5	MONa	Ach Monitor Output	21	CTH	Pop Noise reduction for Treble Control
6	SR FIL	Surround Filter	22	AGC	AGC Filter
7	TONE-Ha	Ach Treble Filter	23	OUTb	Bch Output
8	TONE-La	Ach Bass Filter	24	LINEb	Bch LINE Output (+4.5dB)
9	LINEa	Ach LINE Output (+4.5dB)	25	TONE-Lb	Bch Bass Filter
10	OUTa	Ach Output	26	TONE-Hb	Bch Treble Filter
11	CVA	Pop Noise Reduction for Ach Volume & Balance	27	CSR	Pop Noise Reduction for Surround Control
12	CVB	Pop Noise Reduction for Bch Volume & Balance	28	MONb	Bch Monitor Output
13	SDA	SDA Data Input (I ² C BUS)	29	IN4b	Bch Input 4
14	SCL	SCL Clock Input (I ² C BUS)	30	IN3b	Bch Input 3
15	GND	GND Terminal	31	IN2b	Bch Input 2
16	NC	No Connect	32	IN1b	Bch Input 1

■ABSOLUTE MAXIMUM RATING (Ta=25°C)

PARAMETER	SYMBOL	RATING	UNIT
Supply Voltage	V ⁺	12	V
Power Dissipation	P _D	800 NOTE: EIA/JEDEC STANDARD Test board (76.2x114.3x1.6mm, 2layer, FR-4) mounting	mW
Operating Temperature Range	T _{opr}	-20 to +75	°C
Storage Temperature Range	T _{stg}	-40 to +125	°C

■ELECTRICAL CHARACTERISTICS (Ta=25°C, V⁺=9V, R_g=600Ω, R_L=47kΩ, Vin=100mVrms/1kHz)

PARAMETER	SYMBOL	TEST CONDITION	MIN.	TYP.	MAX.	UNIT
Operating Voltage	V ⁺		8.0	9.0	10.0	V
Supply Current	I _{CC}	No Signal	-	10.0	25.0	mA
Reference Voltage	V _{REF}	No Signal	4.0	4.5	5.0	V
Maximum Input Voltage	V _{IM}	VOL=-20dB, THD=3%	2.8	3.0	-	Vrms
Maximum Output Voltage1	V _{OM1}	OUTPUT VOL=0dB, THD=1%	-	2.5	-	Vrms
Maximum Output Voltage2	V _{OM2}	LINEOUT VOL=0dB, THD=1%	-	2.5	-	Vrms
MON OUT Gain	G _{VMON}	MON OUT	-1.0	0.0	1.0	dB
LINEOUT Gain	G _{VLINE}	LINEOUT, VOL=0dB	2.5	4.5	6.5	dB
Maximum Gain	G _{VMAX}	VOL=0dB	-2.0	0.0	2.0	dB
Minimum Gain	G _{VMIN}	VOL=Mute, Vin=1Vrms BW=400Hz to 30kHz	-	-	-70	dB
Channel Balance	G _{CB}	VOL=0dB	-1.5	0.0	1.5	dB
Balance Boost A	BA _{BST}	CHS="0",BAL="11111"	-2.0	0.0	2.0	dB
Balance Cut A	BA _{CUT}	CHS="1",BAL="11111" Vin = 1Vrms BW=400Hz to 30kHz	-	-	-70	dB
Balance Boost B	BB _{BST}	CHS="1",BAL="11111"	-2.0	0.0	2.0	dB
Balance Cut B	BB _{CUT}	CHS="0",BAL="11111" Vin = 1Vrms BW=400Hz to 30kHz	-	-	-70	dB
Total Harmonic Distortion	THD	Vo=0.5Vrms BW=400Hz to 30kHz	-	-	0.5	%
Input Selector Cross Talk	CT	Vin=1Vrms BW=400Hz to 30kHz	-	-	-70	dB
Channel Separation	CS	Vin=1Vrms BW=400Hz to 30kHz	-	-	-70	dB
Output Noise 1	V _{NO1}	VOL=0dB BW=400Hz to 30kHz	-	-90 (31.6)	-85 (56.2)	dBV (μVrms)
Output Noise 2	V _{NO2}	VOL=Mute BW=400Hz to 30kHz	-	-106 (5.0)	-96 (15.8)	dBV (μVrms)
Output Noise 3	V _{NO3}	LINEOUT, VOL=0dB BW=400Hz to 30kHz	-	-85 (56.2)	-80 (100)	dBV (μVrms)
Output Noise 4	V _{NO4}	LINEOUT, VOL=Mute BW=400Hz to 30kHz	-	-101 (8.9)	-91 (28.2)	dBV (μVrms)

■ **ELECTRICAL CHARACTERISTICS** ($T_a=25^{\circ}\text{C}$, $V^+=9\text{V}$, $R_g=600\Omega$, $R_L=47\text{k}\Omega$, $V_{in}=100\text{mVrms}/1\text{kHz}$)

• **TONE CONTROL** (Tone Control-ON)

PARAMETER	SYMBOL	TEST CONDITION	MIN.	TYP.	MAX.	UNIT
High Frequency Boost	HF _{BST}	TREBLE=+15dB, f=10kHz	12.5	15.0	17.5	dB
High Frequency Flat	HF _{FLT}	TRBE=0dB, f=10kHz	-2.0	0.0	2.0	dB
High Frequency Cut	HF _{CUT}	TREBLE=-15dB, f=10kHz	-17.5	-15.0	-12.5	dB
Low Frequency Boost	LF _{BST}	BASS=+15dB, f=100Hz	12.5	15.0	17.5	dB
Low Frequency Flat	LF _{FLT}	BASS=0dB, f=100Hz	-2.0	0.0	2.0	dB
Low Frequency Cut	LF _{CUT}	BASS=-15dB, f=100Hz	-17.5	-15.0	-12.5	dB

• **AGC** (AGC-ON)

PARAMETER	SYMBOL	TEST CONDITION	MIN.	TYP.	MAX.	UNIT
AGC BOOST	AGC _{BST}	$V_{in}=50\text{mVrms}$	1.5	3.5	5.5	dB
AGC FLAT 1	AGC _{FLT1}	$V_{in}=300\text{mVrms}$	-2.5	0.0	2.5	dB
AGC FLAT 2	AGC _{FLT2}	$V_{in}=400\text{mVrms}$	-2.5	0.0	2.5	dB
AGC FLAT 3	AGC _{FLT3}	$V_{in}=500\text{mVrms}$	-2.5	0.0	2.5	dB
AGC FLAT 4	AGC _{FLT4}	$V_{in}=600\text{mVrms}$	-2.5	0.0	2.5	dB
AGC CUT	AGC _{CUT}	$V_{in}=2\text{Vrms}$	-14	-10	-6.0	dB

• **SURROUND** (SURROUND-ON)

PARAMETER	SYMBOL	TEST CONDITION	MIN.	TYP.	MAX.	UNIT
Simulated Stereo A	SR _{SIMA}	$A_{in}+B_{in} \rightarrow A_{out}$, f=1kHz	1.0	3.0	5.0	dB
Simulated Stereo B	SR _{SIMB}	$A_{in}+B_{in} \rightarrow B_{out}$, f=1kHz	1.0	3.0	5.0	dB
Surround 3D1	SR _{3D1}	$A_{in} \rightarrow A_{out}$, f=100Hz	8.0	10.0	12.0	dB
Surround 3D2	SR _{3D2}	$A_{in} \rightarrow A_{out}$, f=10kHz	-2.0	0.0	2.0	dB
Surround 3D3	SR _{3D3}	$A_{in} \rightarrow B_{out}$, f=100Hz	4.5	6.5	8.5	dB

■ I²C BUS BLOCK CHARACTERISTICS (SDA,SCL)

I²C BUS Load Conditions: Pull up resistance 4kΩ (Connected to +5V), Load capacitance 200pF (Connected to GND)

PARAMETER	SYMBOL	Standard mode			Fast mode			UNIT
		MIN.	TYP.	MAX.	MIN.	TYP.	MAX.	
Low Level Input Voltage	V _{IL}	0.0	-	1.5	0.0	-	1.5	V
High Level Input Voltage	V _{IH}	2.7	-	5.0	2.7	-	5.0	V
Hysteresis of Schmitt trigger inputs	V _{hys}	-	-	-	0.25	-	-	V
Low level output voltage (3mA at SDA pin)	V _{OL}	0	-	0.4	0	-	0.4	V
Output fall time from V _{IHmin} to V _{ILmax} with a bus capacitance from 10pF to 400pF	t _{of}	-	-	250	20 +0.1C _b	-	250	ns
Pulse width of spikes which must be suppressed by the input filter	t _{SP}	-	-	-	0	-	50	ns
Input current each I/O pin with an input voltage between 0.1V _{DD} and 0.9V _{DDmax}	I _i	-10	-	10	-10	-	10	μA
Capacitance for each I/O pin	C _i	-	-	10	-	-	10	pF
SCL clock frequency	f _{SCL}	-	-	100	-	-	400	kHz
Hold time (repeated) START condition.	t _{HD:STA}	4.0	-	-	0.6	-	-	μs
Low period of the SCL clock	t _{LOW}	4.7	-	-	1.3	-	-	μs
High period of the SCL clock	t _{HIGH}	4.0	-	-	0.6	-	-	μs
Set-up time for a repeated START condition	t _{SU:STA}	4.7	-	-	0.6	-	-	μs
Data hold time	t _{HD:DAT}	0	-	3.45	0	-	0.9	μs
Data set-up time	t _{SU:DAT}	250	-	-	100	-	-	ns
Rise time of both SDA and SCL signals	t _r	-	-	1000	-	-	300	ns
Fall time of both SDA and SCL signals	t _f	-	-	300	-	-	300	ns
Set-up time for STOP condition	t _{SU:STO}	4.0	-	-	0.6	-	-	μs
Bus free time between a STOP and START condition	t _{BUF}	4.7	-	-	1.3	-	-	μs
Capacitive load for each bus line	C _b	-	-	400	-	-	400	pF
Noise margin at the Low level	V _{nL}	0.5	-	-	0.5	-	-	V
Noise margin at the High level	V _{nH}	1	-	-	1	-	-	V

C_b ; total capacitance of one bus line in pF.

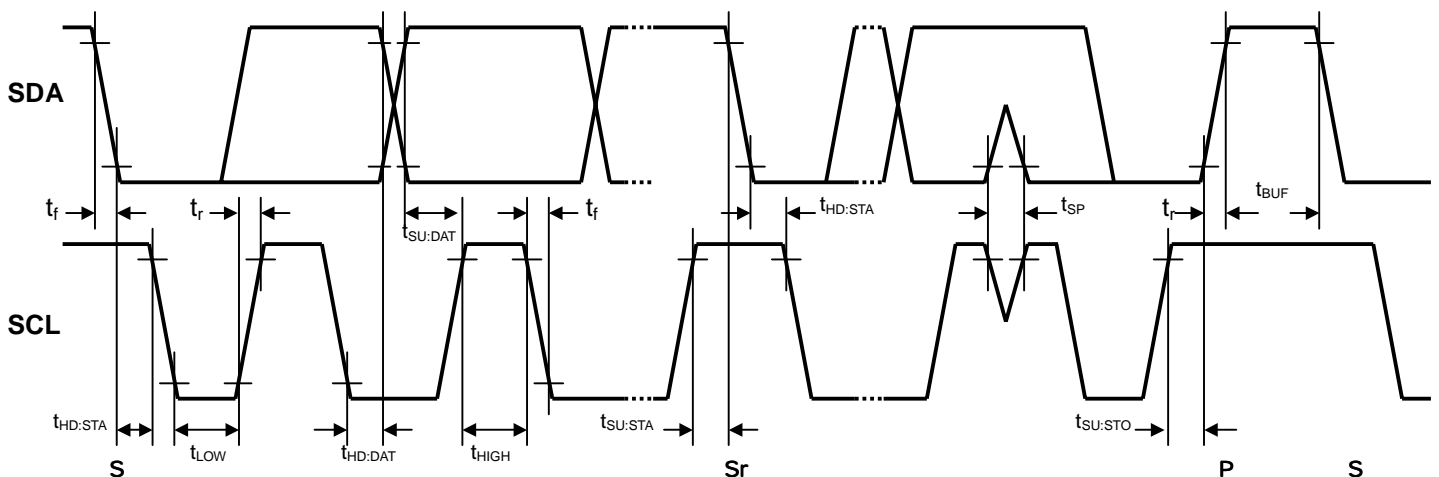

■TERMINAL DESCRIPTION

No.	SYMBOL	FUNCTION	EQUIVALENT CIRCUIT	VOLTAGE
1 2 3 4 29 30 31 32	IN1a IN2a IN3a IN4a IN4b IN3b IN2b IN1b	Ach Input 1 Ach Input 2 Ach Input 3 Ach Input 4 Bch Input 4 Bch Input 3 Bch Input 2 Bch Input 1		V+/2
5 9 10 23 24 28	MONa LINEa OUTa OUTb LINEb MONb	Ach Monitor Output (0dB) Ach LINE Output (4.5dB) Ach Output (0dB) Bch Output (0dB) Bch LINE Output (4.5dB) Bch Monitor Output (0dB)		V+/2
6	SR FIL	Surround Filter		V+/2
7 26	TONE-Ha TONE-Hb	Ach Treble Filter Bch Treble Filter		V+/2
8 25	TONE-La TONE-Lb	Ach Bass Filter Bch Bass Filter		V+/2

■ TERMINAL DESCRIPTION

No.	SYMBOL	FUNCTION	EQUIVALENT CIRCUIT	VOLTAGE
22	AGC	AGC Filter		0.6V
11 12	CVa CVb	Pop Noise Reduction for Ach Volume & Balance Pop Noise Reduction for Bch Volume & Balance		$V+/2 - 0.7V$
13 14	SDA SCL	SDA Data Input (I ² C BUS) SCL Clock Input (I ² C BUS)		-
15	GND	GND Terminal	—————	0V
18	V+	Power Supply Terminal	—————	V+
19	Vref	Reference Voltage		$V+/2$

■ TERMINAL DESCRIPTION

No.	SYMBOL	FUNCTION	EQUIVALENT CIRCUIT	VOLTAGE
20 21	CTL CTH	Pop Noise reduction for Bass Control Pop Noise reduction for Treble Control		$V_{+}/2 - 0.7V$
27	CSR	Pop Noise Reduction for Surround Control		0.6V

APPLICATION CIRCUIT

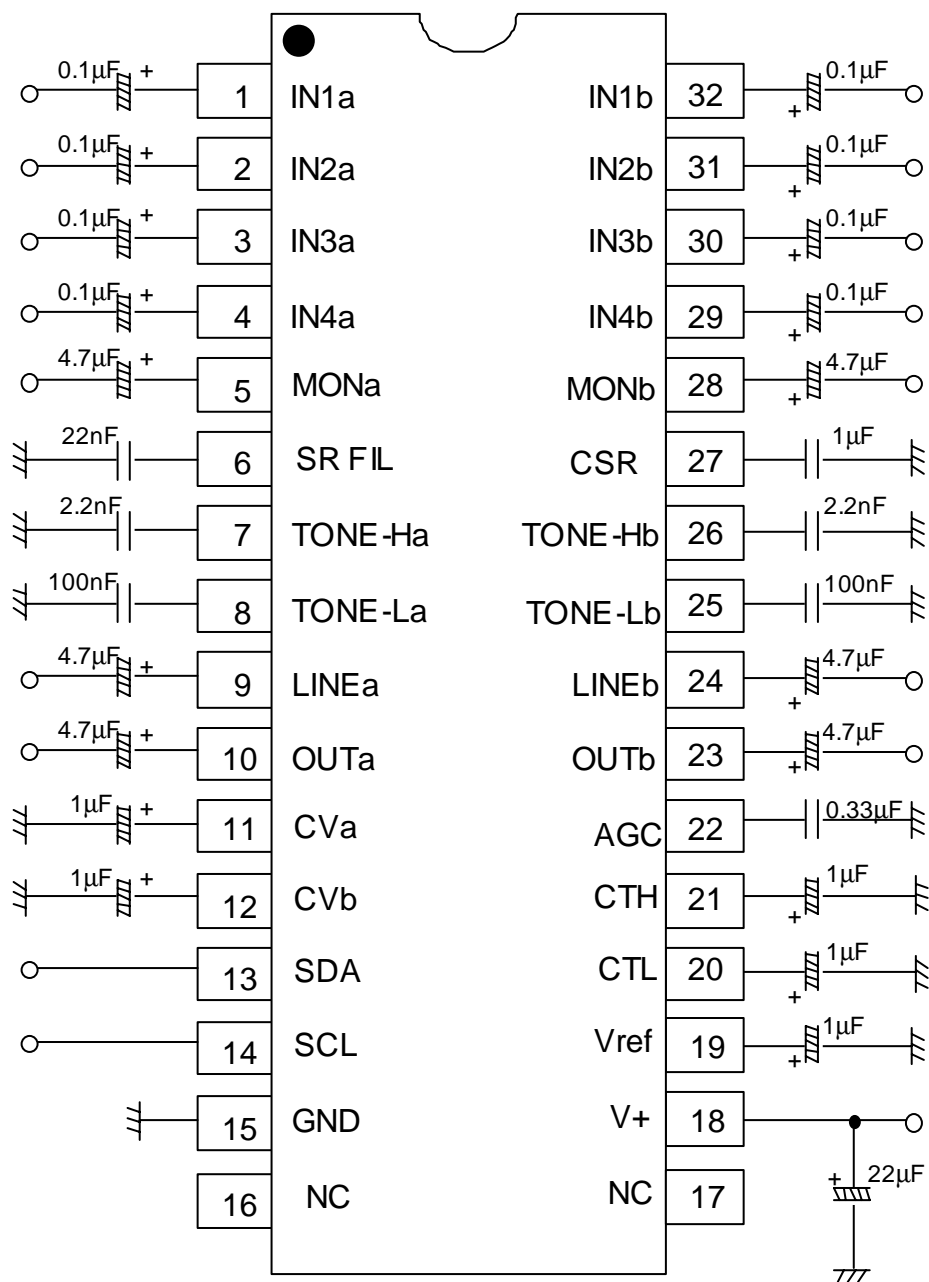

(NOTE)

1. Separate the I²C bus line from the following terminals for avoiding digital noise problem.

Pin No.	Symbol	Pin No.	Symbol	Pin No.	Symbol
6	SS FIL	8	TONE-La	26	TONE-Hb
7	TONE-Ha	25	TONE-Lb	-	-

■ DEFINITION OF I²C REGISTER

◆ I²C BUS FORMAT

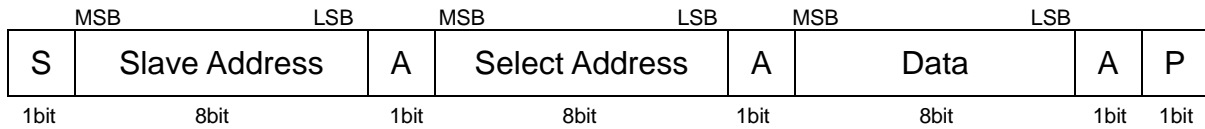

S: Starting Term
 A: Acknowledge Bit
 P: Ending Term

◆ SLAVE ADDRESS

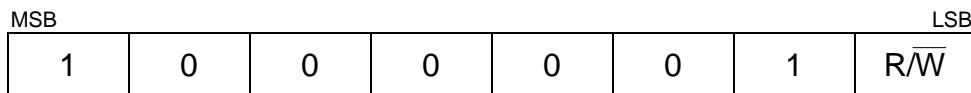

R/W=0: Write mode for register setting
 R/W=1: Not available

◆ CONTROL REGISTER TABLE

The select address sets each function (Volume, Balance, AGC, Surround, Tone Control, AUX).
 The auto increment function cycles the select address as follows.
 00H→01H→02H→03H→04H→05H→00H

Select Address	BIT							
	D7	D6	D5	D4	D3	D2	D1	D0
00H	VOL							
01H	CHS	BAL					SUR1	SUR0
02H	BCB	BASS			BCSB	SUB-BASS		
03H	BCT	TREB			BCST	SUB-TREB		
04H	Don't Care							
05H	OUT	SEL			AGC1	AGC0	AGC	Don't Care

◆ CONTROL REGISTER DEFAULT VALUE

Control register default value is all "0".

Select Address	BIT							
	D7	D6	D5	D4	D3	D2	D1	D0
00H	0	0	0	0	0	0	0	0
01H	0	0	0	0	0	0	0	0
02H	0	0	0	0	0	0	0	0
03H	0	0	0	0	0	0	0	0
04H	0	0	0	0	0	0	0	0
05H	0	0	0	0	0	0	0	0

■ I²C CONTROL COMMAND DESCRIPTION

• MASTER VOLUME CONTROL

Select Address	BIT							
	D7	D6	D5	D4	D3	D2	D1	D0
00H	VOL							

The volume control for both Ach and Bch (0.33dB/step).

The volume is consisted of volume1 and volume2 and the level is divided into half to each volume1 and volume2.

• BALANCE, AGC AND SURROUND SETTING

Select Address	BIT							
	D7	D6	D5	D4	D3	D2	D1	D0
01H	CHS	BAL					SR1	SR0

- CHS: Channel select for balance control

“0”: Ach “Bch is attenuated”

“1”: Bch “Ach is attenuated”

- BAL: Balance control for both Ach and Bch (1dB/Step)

The balance is consisted of volume1 and volume2 and the level is divided into half to each volume1 and volume2.

- “SR1”, “SR0”: Surround Mode select

Surround Mode	SR1 (D1)	SR0 (D0)
Surround Off (Bypass)	0	0
Simulated Stereo	0	1
eala effect large	1	0
eala effect small	1	1

• TONE CONTROL BASS SETTING

Select Address	BIT							
	D7	D6	D5	D4	D3	D2	D1	D0
02H	BCB	BASS					BCSB	SUB-BASS

- BCB: Boost cut select for Bass control

“0”: Cut

“1”: Boost

- BASS: BASS control

Cut Level: -15dB to 0dB (1dB/Step)

Boost Level: 0dB to +15dB (1dB/Step)

- BCSB: Boost cut select for SUB-BASS control

“0”: Cut

“1”: Boost

- SUB-BASS: SUB- BASS control (1dB/Step)

Sub-Cut Level: -3dB to 0dB (1dB/Step)

Sub-Boost Level: 0dB to +3dB (1dB/Step)

• TONE CONTROL TREBLE SETTING

Select Address	BIT							
	D7	D6	D5	D4	D3	D2	D1	D0
03H	BCT	TREB				BCST	SUB-TREB	

- BCT: Boost cut select for Treble control
 “0”: Cut
 “1”: Boost
- TREB: Treble control (1dB/step)
 Cut Level: -15dB to 0dB (1dB/Step)
 Boost Level: 0dB to +15dB (1dB/Step)
- BCST: Boost cut select for Sub-Treble control
 “0”: Cut
 “1”: Boost
- SUB-TREB: Sub-Treble control (1dB/step)
 Sub-Cut Level: -3dB to 0dB (1dB/Step)
 Sub-Boost Level: 0dB to +3dB (1dB/Step)

• OUTPUT AND AUXILIARY SETTING

Select Address	BIT							
	D7	D6	D5	D4	D3	D2	D1	D0
05H	OUT	SEL			AGC1	AGC0	AGC	Don't Care

- OUT: ON/OFF Switch for OUTPUT
 “0”: OFF (MUTE)
 “1”: ON

- SEL: Input Selector

Input Select	SEL		
	D6	D5	D4
IN1a and IN1b	0	1	0
IN2a and IN2b	0	1	1
IN3a and IN3b	1	0	0
IN4a and IN4b	1	0	1

- AGC1: AGC Level Setting

AGC Level	AGC1 (D3)	AGC0 (D2)	AGC (D1)
AGC Flat 1 (300mVrms)	0	0	1
AGC Flat 2 (400mVrms)	0	1	1
AGC Flat 3 (500mVrms)	1	0	1
AGC Flat 4 (600mVrms)	1	1	1
AGC Off	*	*	0

* Don't Care

■MASTER VOLUME (Select Address: 00H)

		VOL							
Gain (dB)	HEX	D7	D6	D5	D4	D3	D2	D1	D0
0	FF	1	1	1	1	1	1	1	1
-1	FC	1	1	1	1	1	1	0	0
-2	F9	1	1	1	1	1	0	0	1
-3	F6	1	1	1	1	0	1	1	0
-4	F3	1	1	1	1	0	0	1	1
-5	F0	1	1	1	1	0	0	0	0
-6	ED	1	1	1	0	1	1	0	1
-7	EA	1	1	1	0	1	0	1	0
-8	E7	1	1	1	0	0	1	1	1
-9	E4	1	1	1	0	0	1	0	0
-10	E1	1	1	1	0	0	0	0	1
-11	DE	1	1	0	1	1	1	1	0
-12	DB	1	1	0	1	1	0	1	1
-13	D8	1	1	0	1	1	0	0	0
-14	D5	1	1	0	1	0	1	0	1
-15	D2	1	1	0	1	0	0	1	0
-16	CF	1	1	0	0	1	1	1	1
-17	CC	1	1	0	0	1	1	0	0
-18	C9	1	1	0	0	1	0	0	1
-19	C6	1	1	0	0	0	1	1	0
-20	C3	1	1	0	0	0	0	1	1
-21	C0	1	1	0	0	0	0	0	0
-22	BD	1	0	1	1	1	1	0	1
-23	BA	1	0	1	1	1	0	1	0
-24	B7	1	0	1	1	0	1	1	1
-25	B4	1	0	1	1	0	1	0	0
-26	B1	1	0	1	1	0	0	0	1
-27	AE	1	0	1	0	1	1	1	0
-28	AB	1	0	1	0	1	0	1	1
-29	A8	1	0	1	0	1	0	0	0
-30	A5	1	0	1	0	0	1	0	1
-31	A2	1	0	1	0	0	0	1	0
-32	9F	1	0	0	1	1	1	1	1
-33	9C	1	0	0	1	1	1	0	0
-34	99	1	0	0	1	1	0	0	1
-35	96	1	0	0	1	0	1	1	0
-36	93	1	0	0	1	0	0	1	1
-37	90	1	0	0	1	0	0	0	0
-38	8D	1	0	0	0	1	1	0	1
-39	8A	1	0	0	0	1	0	1	0
-40	87	1	0	0	0	0	1	1	1
-41	84	1	0	0	0	0	1	0	0
-42	81	1	0	0	0	0	0	0	1

NJW1142A

■MASTER VOLUME (Cont'd)

		VOL							
Gain (dB)	HEX	D7	D6	D5	D4	D3	D2	D1	D0
-43	7E	0	1	1	1	1	1	1	0
-44	7B	0	1	1	1	1	0	1	1
-45	78	0	1	1	1	1	0	0	0
-46	75	0	1	1	1	0	1	0	1
-47	72	0	1	1	1	0	0	1	0
-48	6F	0	1	1	0	1	1	1	1
-49	6C	0	1	1	0	1	1	0	0
-50	69	0	1	1	0	1	0	0	1
-51	66	0	1	1	0	0	1	1	0
-52	63	0	1	1	0	0	0	1	1
-53	60	0	1	1	0	0	0	0	0
-54	5D	0	1	0	1	1	1	0	1
-55	5A	0	1	0	1	1	0	1	0
-56	57	0	1	0	1	0	1	1	1
-57	54	0	1	0	1	0	1	0	0
-58	51	0	1	0	1	0	0	0	1
-59	4E	0	1	0	0	1	1	1	0
-60	4B	0	1	0	0	1	0	1	1
-61	48	0	1	0	0	1	0	0	0
-62	45	0	1	0	0	0	1	0	1
-63	42	0	1	0	0	0	0	1	0
-64	3F	0	0	1	1	1	1	1	1
-65	3C	0	0	1	1	1	1	0	0
-66	39	0	0	1	1	1	0	0	1
-67	36	0	0	1	1	0	1	1	0
-68	33	0	0	1	1	0	0	1	1
-69	30	0	0	1	1	0	0	0	0
-70	2D	0	0	1	0	1	1	0	1
-71	2A	0	0	1	0	1	0	1	0
-72	27	0	0	1	0	0	1	1	1
-73	24	0	0	1	0	0	1	0	0
-74	21	0	0	1	0	0	0	0	1
-75	1E	0	0	0	1	1	1	1	0
-76	1B	0	0	0	1	1	0	1	1
-77	18	0	0	0	1	1	0	0	0
-78	15	0	0	0	1	0	1	0	1
-79	12	0	0	0	1	0	0	1	0
-80	0F	0	0	0	0	1	1	1	1
-81	0C	0	0	0	0	1	1	0	0
-82	09	0	0	0	0	1	0	0	1
-83	06	0	0	0	0	0	1	1	0
-84	03	0	0	0	0	0	0	1	1
Mute	00	0	0	0	0	0	0	0	0

■BALANCE (Select Address: 01H)

Channel Select (CHS)	D7
Ach (Bch is attenuated)	0
Bch (Ach is attenuated)	1

Gain (dB)	BAL				
	D6	D5	D4	D3	D2
0	0	0	0	0	0
-1	0	0	0	0	1
-2	0	0	0	1	0
-3	0	0	0	1	1
-4	0	0	1	0	0
-5	0	0	1	0	1
-6	0	0	1	1	0
-7	0	0	1	1	1
-8	0	1	0	0	0
-9	0	1	0	0	1
-10	0	1	0	1	0
-11	0	1	0	1	1
-12	0	1	1	0	0
-13	0	1	1	0	1
-14	0	1	1	1	0
-15	0	1	1	1	1
-16	1	0	0	0	0
-17	1	0	0	0	1
-18	1	0	0	1	0
-19	1	0	0	1	1
-20	1	0	1	0	0
-21	1	0	1	0	1
-22	1	0	1	1	0
-23	1	0	1	1	1
-24	1	1	0	0	0
-25	1	1	0	0	1
-26	1	1	0	1	0
-27	1	1	0	1	1
-28	1	1	1	0	0
-29	1	1	1	0	1
-30	1	1	1	1	0
Mute	1	1	1	1	1

■TONE CONTROL BASS (Select Address: 02H)

Bass Cut or Boost	BCB
	D7
Cut	0
Boost	1

		BASS			
		D6	D5	D4	D3
Cut Gain (dB)	Boost Gain (dB)				
-15	15	1	1	1	1
-14	14	1	1	1	0
-13	13	1	1	0	1
-12	12	1	1	0	0
-11	11	1	0	1	1
-10	10	1	0	1	0
-9	9	1	0	0	1
-8	8	1	0	0	0
-7	7	0	1	1	1
-6	6	0	1	1	0
-5	5	0	1	0	1
-4	4	0	1	0	0
-3	3	0	0	1	1
-2	2	0	0	1	0
-1	1	0	0	0	1
0	0	0	0	0	0

■TONE CONTROL SUB-BASS (Select Address: 02H)

Sub-Bass Cut or Boost	BCSB
	D2
Cut	0
Boost	1

		SUB-BASS	
		D1	D0
Cut Gain (dB)	Boost Gain (dB)		
-3	3	1	1
-2	2	1	0
-1	1	0	1
0	0	0	0

■TONE CONTROL TREBLE (Select Address: 03H)

Treble Cut or Boost	BCT
	D7
Cut	0
Boost	1

		TREB			
		D6	D5	D4	D3
Cut Gain (dB)	Boost Gain (dB)				
-15	15	1	1	1	1
-14	14	1	1	1	0
-13	13	1	1	0	1
-12	12	1	1	0	0
-11	11	1	0	1	1
-10	10	1	0	1	0
-9	9	1	0	0	1
-8	8	1	0	0	0
-7	7	0	1	1	1
-6	6	0	1	1	0
-5	5	0	1	0	1
-4	4	0	1	0	0
-3	3	0	0	1	1
-2	2	0	0	1	0
-1	1	0	0	0	1
0	0	0	0	0	0

■TONE CONTROL SUB-TREBLE (Select Address: 03H)

Sub-Treble Cut or Boost	BCST
	D2
Cut	0
Boost	1

		SUB-TREB	
		D1	D1
Cut Gain (dB)	Boost Gain (dB)		
-3	3	1	1
-2	2	1	0
-1	1	0	1
0	0	0	0

■ TYPICAL CHARACTERISTICS

Supply Current vs Supply Voltage

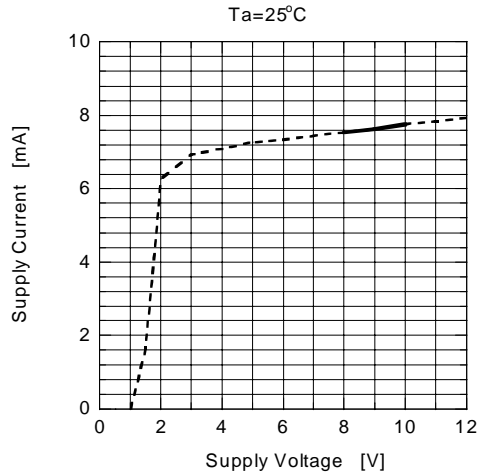

Supply Current vs Temperature

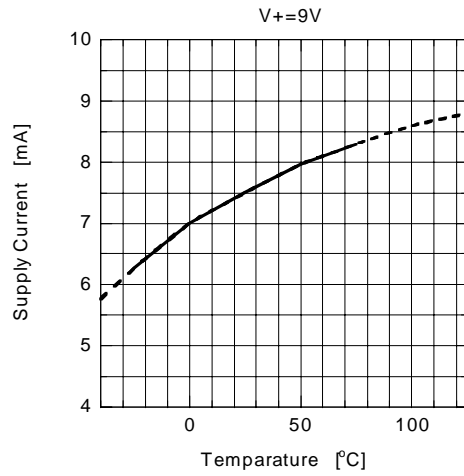

Gain vs Volume Control

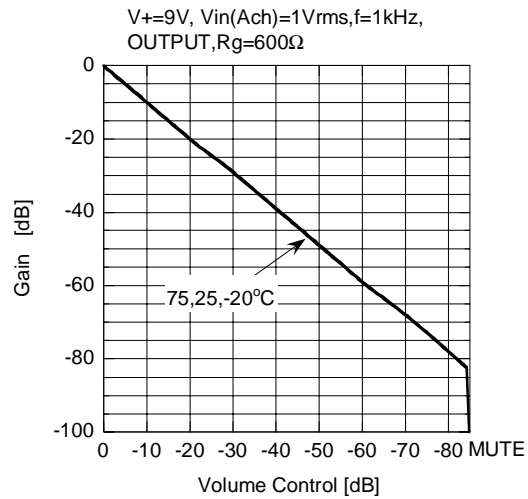

Gain vs Balance Control

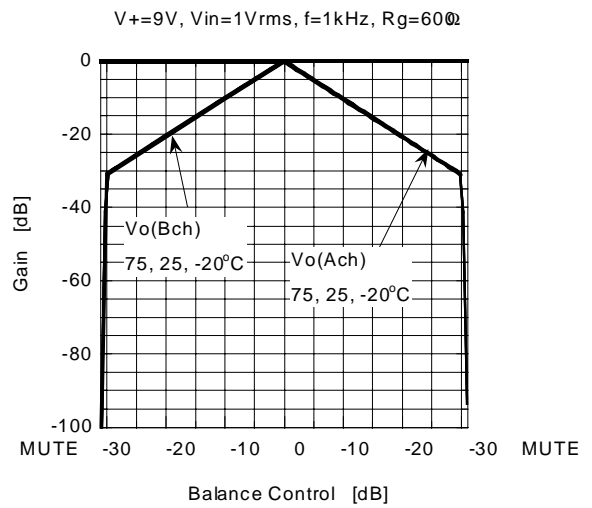

Output Noise vs Volume Control

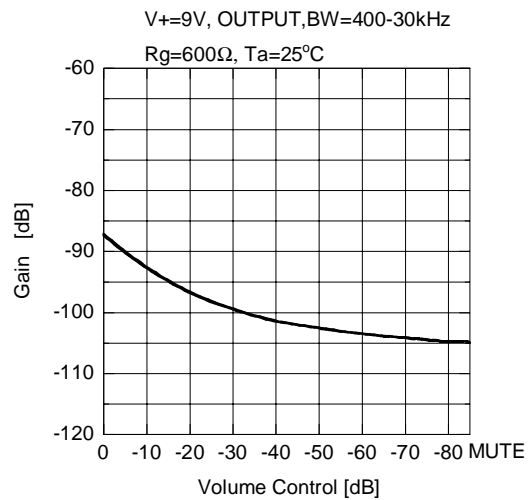

Output Noise vs Temperature

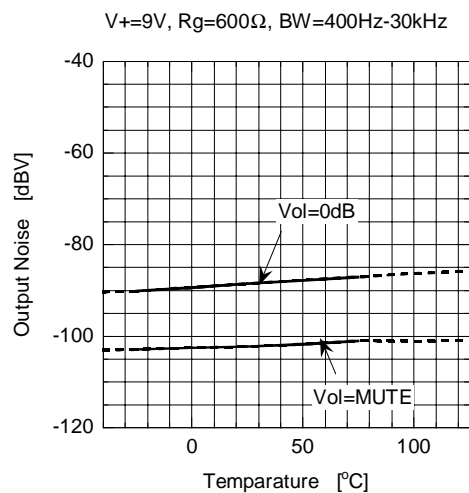

TYPICAL CHARACTERISTICS

THD+N vs Input Voltage

$V_{+}=9V$, $V_{in}(Ach)$, $f=1kHz$, $V_{o}(Ach)OUTPUT$
 $R_g=600\Omega$, $BW=400Hz-30kHz$, $T_a=25^{\circ}C$

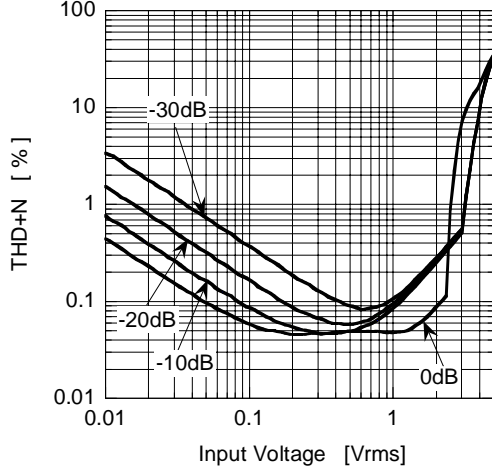

THD+N vs Input Voltage

$V_{+}=9V$, $V_{in}(Ach)$, $f=1kHz$, $V_{o}(Ach)OUTPUT$
 $R_g=600\Omega$, $BW=400Hz-30kHz$, $V_{ol}=-20dB$

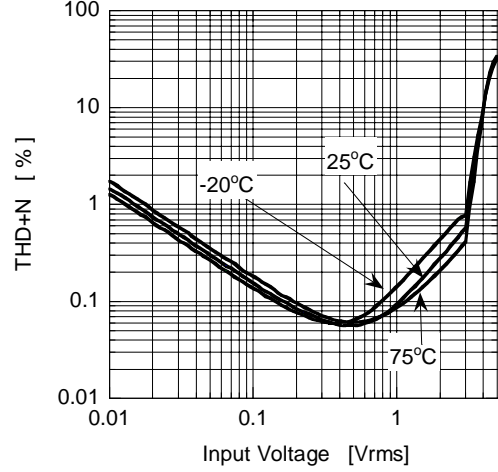

THD+N vs Output Voltage

$V_{+}=9V$, $V_{in}(Ach)$, $f=1kHz$, $V_{o}(Ach)OUTPUT$
 $BW=400Hz-30kHz$, $R_g=600\Omega$, $T_a=25^{\circ}C$

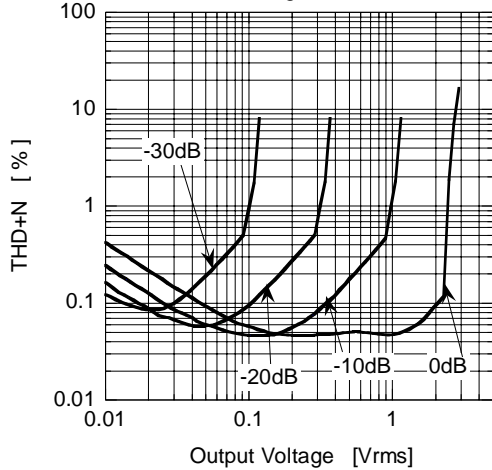

THD+N vs Output Voltage

$V_{+}=9V$, $V_{in}(Ach)$, $f=1kHz$, $V_{o}(Ach)OUTPUT$
 $R_g=600\Omega$, $BW=400Hz-30kHz$, $V_{ol}=0dB$

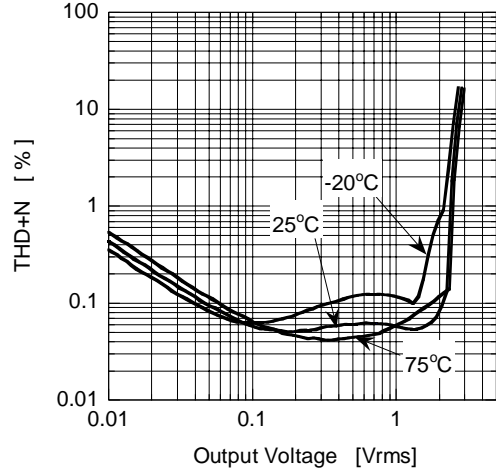

MUTE Level vs Frequency

$V_{+}=9V$, $V_{in}(Ach)=1V_{rms}$, $V_{ol}=MUTE$
 $V_{o}(Ach)OUTPUT$, $R_g=600\Omega$, $T_a=25^{\circ}C$

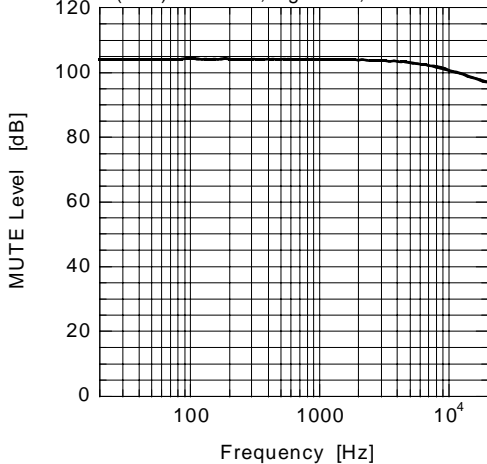

Channel Separation vs Frequency

$V_{+}=9V$, $V_{in}=1V_{rms}$, $f=1kHz$, $V_{o}=OUTPUT$
 $R_g=600\Omega$, $V_{ol}=0dB$, $T_a=25^{\circ}C$

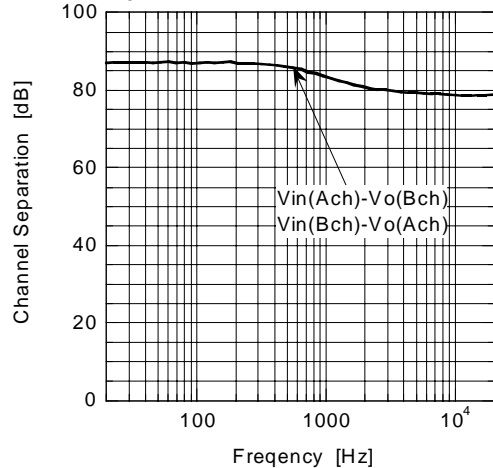

■TYPICAL CHARACTERISTICS

Gain vs Frequency (TONE)

V+=9V, Vin(Ach)=0.1Vrms, Gv:3dB steps
Vo(Ach), Rg=600Ω, Ta=25°C

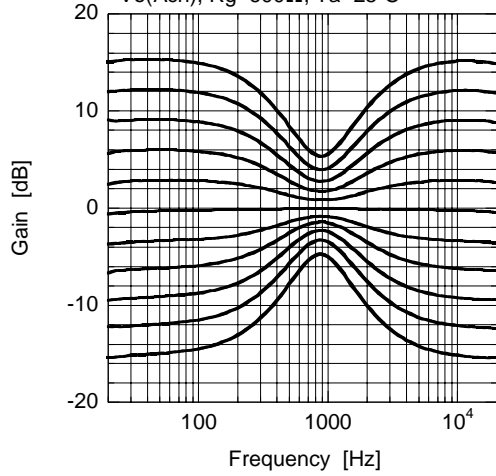

AGC Control

V+=9V, Vin(Ach+Bch), f=1kHz, Vo(Ach)OUTPUT
Rg=600Ω, Ta=25°C

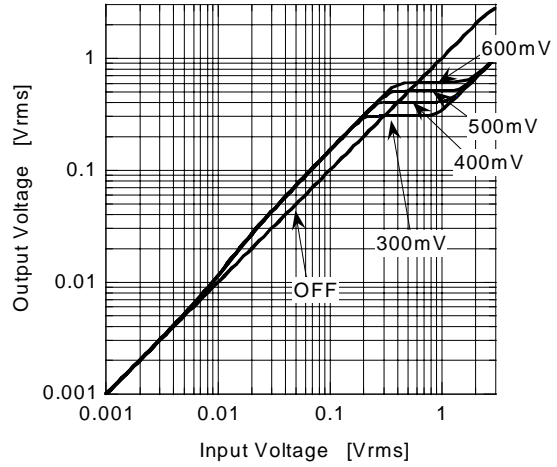

AGC Attack Time (C:20pin=0.33μF)

V+=9V, Vin(Ach+Bch)=1Vrms, f=20kHz, Vo(Ach)OUTPUT
AGC level=0.3V, Rg=600Ω, Ta=25°C

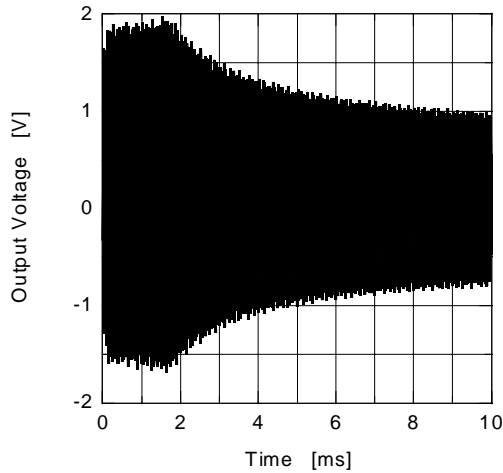

AGC Recovery Time (C:20pin=0.33μF)

V+=9V, Vin(Ach+Bch)=1Vrms, f=10kHz, Vo(Ach)OUTPUT
AGC level=0.3V, Rg=600Ω, Ta=25°C

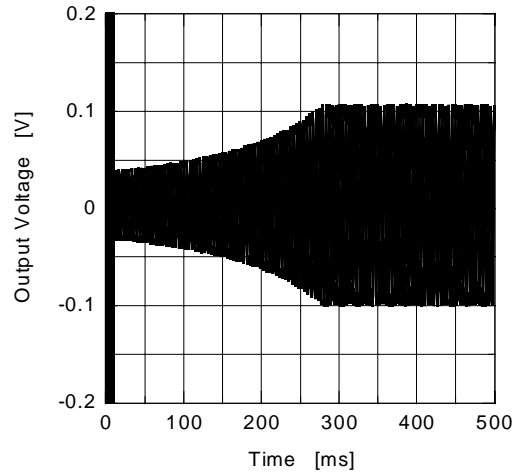

Gain vs Frequency (eala&Simulated)

V+=9V, Vin=0.1Vrms, OUTPUT, Rg=600Ω,
Ta=25°C

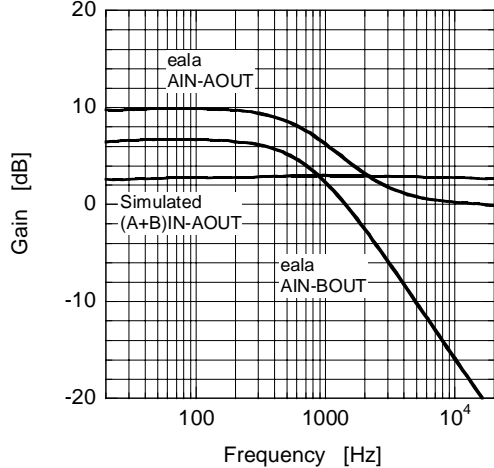

Phase vs Frequency (Simulated)

V+=9V, Vin(A+Bch)=0.1Vrms, Rg=600Ω,
Ta=25°C

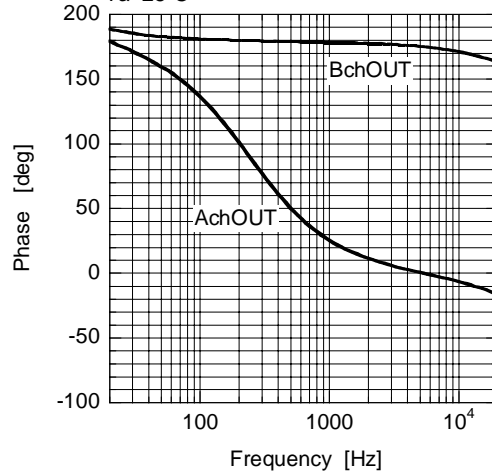

[CAUTION]

The specifications on this databook are only given for information, without any guarantee as regards either mistakes or omissions. The application circuits in this databook are described only to show representative usages of the product and not intended for the guarantee or permission of any right including the industrial rights.