

20–40 GHz Amplifier

Technical Data

HMMC-5040

Features

- **Large Bandwidth:**
20 - 44 GHz Typical
21 - 40 GHz Specified
- **High Gain:** 22 dB Typical
- **Saturated Output Power:**
21 dBm Typical
- **Supply Bias:**
≤ 4.5 volts @ ≤ 300 mA

Description

The HMMC-5040 is a high-gain broadband MMIC amplifier designed for both military applications and commercial communication systems. This four stage amplifier has input and output matching circuitry for use in 50 ohm environments. It is fabricated using a PHEMT integrated circuit structure that provides exceptional broadband performance. The backside of the chip is both RF and DC ground. This helps simplify the assembly process and reduces assembly related performance variations and costs. This MMIC is a cost effective alternative to hybrid (discrete-FET) amplifiers that require complex tuning and assembly processes.

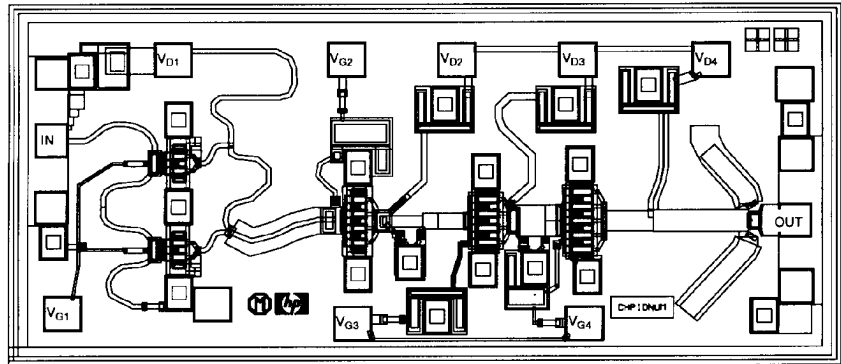

Chip Size: 1720 x 760 μm (67.7 x 29.9 mils)
 Chip Size Tolerance: $\pm 10 \mu\text{m}$ (± 0.4 mils)
 Chip Thickness: $127 \pm 15 \mu\text{m}$ (5.0 ± 0.6 mils)
 Pad Dimensions: $80 \times 80 \mu\text{m}$ (3.1×3.1 mils)

Absolute Maximum Ratings^[1]

Symbol	Parameters/Conditions	Units	Min.	Max.
$V_{D1,2-3-4}$	Drain Supply Voltages	V		5
$V_{G1,2-3-4}$	Gate Supply Voltages	V	-3.0	0.5
I_{DD}	Total Drain Current	mA		400
P_{in}	RF Input Power	dBm		21
T_{ch}	Channel Temperature ^[2]	$^{\circ}\text{C}$		+160
T_A	Backside Ambient Temp.	$^{\circ}\text{C}$	-55	+75
T_{STG}	Storage Temperature	$^{\circ}\text{C}$	-65	+165
T_{max}	Maximum Assembly Temp.	$^{\circ}\text{C}$		+300

Note:

1. Absolute maximum ratings for continuous operation unless otherwise noted.
2. Refer to DC Specifications/Physical Properties table for derating information.

HMMC-5040 DC Specifications/Physical Properties^[1]

Symbol	Parameters and Test Conditions	Units	Min.	Typ.	Max.
$V_{D1,2-3-4}$	Drain Supply Operating Voltages	V	2	4.5	5
I_{D1}	First Stage Drain Supply Current ($V_{DD} = 4.5\text{ V}$, $V_{G1} = -0.6\text{ V}$)	mA		55	
I_{D2-3-4}	Total Drain Supply Current for Stages 2, 3, and 4 ($V_{DD} = 4.5\text{ V}$, $V_{GG} = -0.6\text{ V}$)	mA		24.5	
$V_{G1,2,3-4}$	Gate Supply Operating Voltages ($I_{DD} = 300\text{ mA}$)	V		-0.6	
V_p	Pinch-off Voltage ($V_{DD} = 4.5\text{ V}$, $I_{DD} \leq 10\text{ mA}$)	V	-2	-1.2	-0.8
θ_{ch-bs}	Thermal Resistance ^[2] (Channel-to-Backside @ $T_{ch} = 160^\circ\text{C}$)	$^\circ\text{C/W}$		62	
T_{ch}	Channel Temperature ^[3] ($T_A = 125^\circ\text{C}$, MTTF > 10^6 hrs, $V_{DD} = 4.5\text{ V}$, $I_{DD} = 300\text{ mA}$)	$^\circ\text{C}$		160	

Notes:

1. Backside ambient operating temperature $T_A = 25^\circ\text{C}$ unless otherwise noted.
2. Thermal resistance ($^\circ\text{C/Watt}$) at a channel temperature T ($^\circ\text{C}$) can be *estimated* using the equation:
 $\theta(T) \cong 62 \times [T(^\circ\text{C}) + 273] / [160^\circ\text{C} + 273]$.
3. Derate MTTF by a factor of two for every 8°C above T_{ch} .

HMMC-5040 RF Specifications, $T_A = 25^\circ\text{C}$, $V_{DD} = 4.5\text{ V}$, $I_{DD} = 300\text{ mA}$, $Z_o = 50\ \Omega$

Symbol	Parameters/Conditions	Units	Broadband Specifications			Narrow Band Performance		
			Min.	Typ.	Max.	Typical		
BW	Operating Bandwidth	GHz	21	20–44	40	21–24	27–29	37–40
S_{21}	Small Signal Gain	dB	20	22		25	23	22
ΔS_{21}	Small Signal Gain Flatness	dB		± 15		± 1	± 0.75	± 0.3
$(RL_{in})_{MIN}$	Minimum Input Return Loss	dB	8	10		9	10	14
$(RL_{out})_{MIN}$	Minimum Output Return Loss	dB	8	10		10	11	12
S_{12}	Reverse Isolation	dB		54		54	54	54
P_{-1dB}	Output Power (@ 1dB Gain Compression)	dBm		18		18	18	18
P_{sat}	Saturated Output Power @ 3 dB Gain Compression	dBm	20	21		21	21	21

HMMC-5040 Applications

The HMMC-5040 broadband amplifier is designed for both military (35 GHz) applications and wireless communication systems that operate at 23, 28, and 38 GHz. It is also suitable for use as a frequency multiplier due to excellent below-band input return loss and high gain.

Biassing and Operation

The recommended DC bias condition is with all drains connected to single 4.5 volt (or less) supply and all gates connected to an adjustable negative voltage supply as shown in Figure 12a. The gate voltage is adjusted for a total drain supply current of typically up to 300 mA. Figures 4, 5, 8, and 9 can be used to help estimate the minimum drain voltage and current necessary for a given RF gain and output power.

The second, third, and fourth stage DC drain bias lines are connected internally (Figure 1) and therefore require only a single bond wire. An additional bond wire is needed for the first stage DC drain bias, V_{D1} .

Only the third and fourth stage DC gate bias lines are connected internally. A total of three DC gate bond wires are required: one for V_{G1} , one for V_{G2} , and one for the V_{G3} -to- V_{G4} connection. The RF input has matching circuitry that creates a 50 ohm DC and RF path to ground. A DC blocking capacitor should be used in the RF input transmission line. Any DC voltage applied to the RF input must be maintained below 1 volt. The RF output is AC-coupled.

No ground wires are needed since ground connections are made with plated through-holes to the backside of the device.

The HMMC-5040 can also be used to double, triple, or quadruple the frequency of input signals. Many bias schemes may be used to generate and amplify desired harmonics within the device. The information given here is intended to be used by the customer as a starting point for such applications. Optimum conversion efficiency is obtained with approximately 14 dBm input drive level.

As a doubler, the device can multiply an input signal in the 10-20 GHz frequency range up to 20-40 GHz with conversion gain for output frequencies exceeding 30 GHz. Similarly, 5-10 GHz signals can be quadrupled to 20-40 GHz with some conversion loss. Frequency doubling or quadrupling is accomplished by operating the first gain stage at pinch-off ($V_{G1} = V_P \cong -1.2$ volts). Stages 2, 3, and 4 are biased for normal amplification. The assembly diagram shown in Figure 12b can be used.

To operate the device as a frequency *tripler* the drain voltage can be reduced to approximately 2.5 volts and the gate voltage can be set at about -0.4 volts or adjusted to minimize second harmonics if needed. Either of Figures 12a or Figure 12b can be used.

Contact your local HP sales representative for additional information concerning multiplier performance and operating conditions.

Assembly Techniques

Solder die attach using a fluxless gold-tin (AuSn) solder preform is the recommended assembly method. A conductive epoxy such as ABLEBOND® 71-1LM1 or ABLEBOND® 36-2 may also be used for die attaching provided the Absolute Maximum Ratings are not exceeded. The device should be attached to an electrically conductive surface to complete the DC and RF ground paths. The backside metallization on the device is gold.

It is recommended that the RF input and output connections be made using either 500 lines/inch (or equivalent) gold wire mesh. The RF connections should be kept as short as possible to minimize inductance. The DC bias supply wires can be 0.7 mil diameter gold.

Thermosonic wedge is the preferred method for wire bonding to the gold bond pads. Mesh wires can be attached using a 2 mil round tacking tool and a tool force of approximately 22 grams with an ultrasonic power of roughly 55 dB for a duration of 76 ± 8 msec. A guided-wedge at an ultrasonic power level of 64 dB can be used for the 0.7 mil wire. The recommended wire bond stage temperature is $150 \pm 2^\circ\text{C}$.

For more detailed information see HP application note #999 "GaAs MMIC Assembly and Handling Guidelines."

GaAs MMICs are ESD sensitive. Proper precautions should be used when handling these devices.

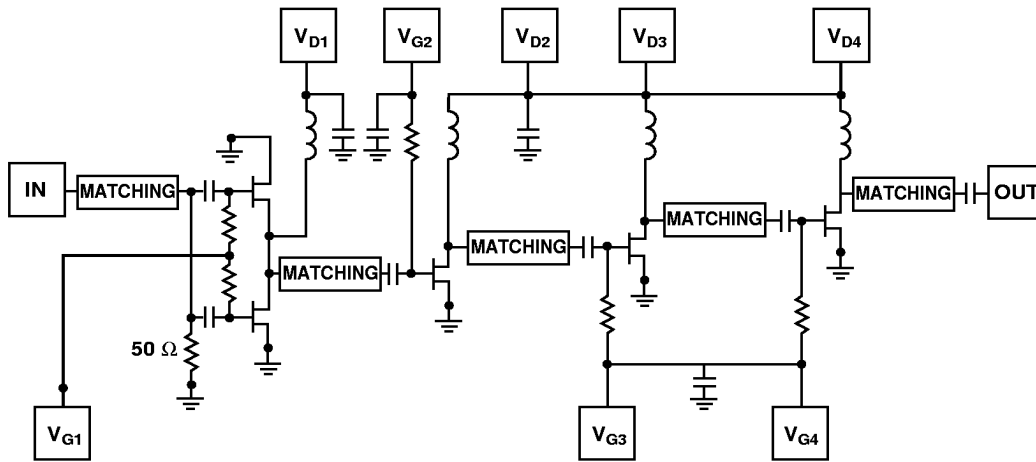

Figure 1. HMMC-5040 Simplified Schematic Diagram.

HMMC-5040 Typical Performance

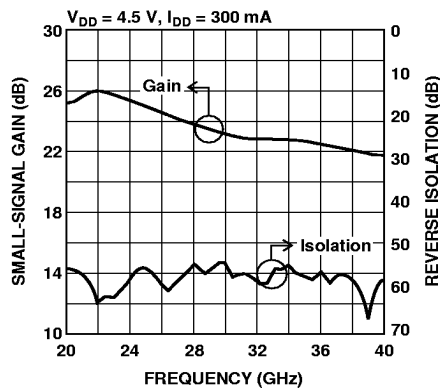

Figure 2. Typical Gain and Isolation vs. Frequency.[1]

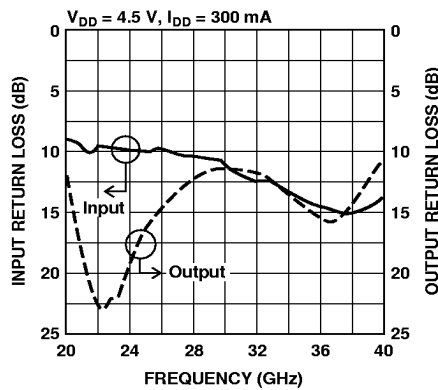

Figure 3. Typical Input and Output Return Loss vs. Frequency.[1]

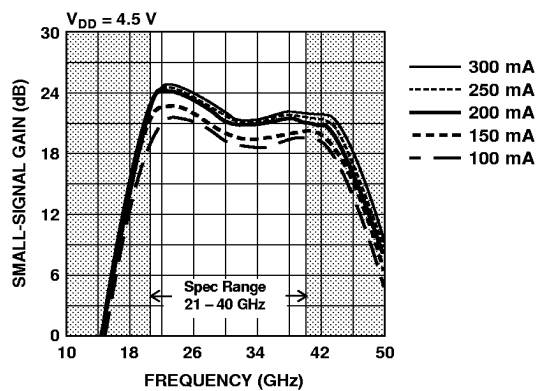

Figure 4. Broadband Gain as a Function of Drain Current vs. Frequency with $V_{DD} = 4.5$ V.[1]

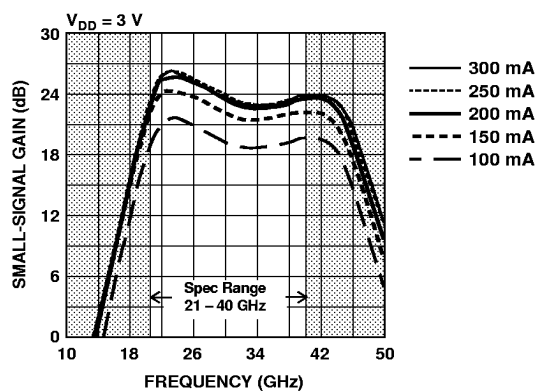

Figure 5. Broadband Gain as a Function of Drain Current vs. Frequency with $V_{DD} = 3$ V.[1]

Note:

1. Wafer-probed measurements

HMMC-5040 Typical Performance, continued

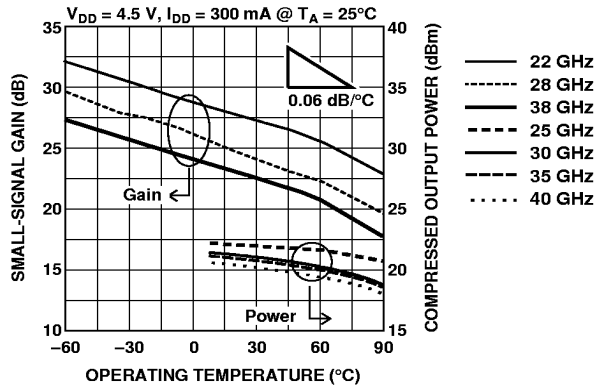

Figure 6. Small-Signal Gain^[3] and Compressed Power^[1] vs. Temperature.

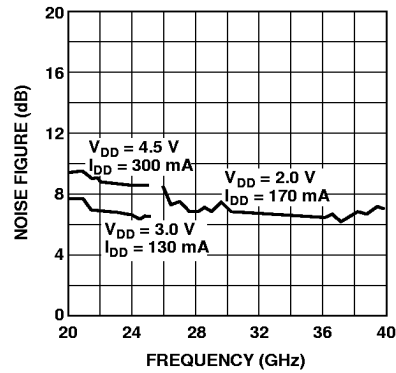

Figure 7. Noise Figure vs. Frequency.

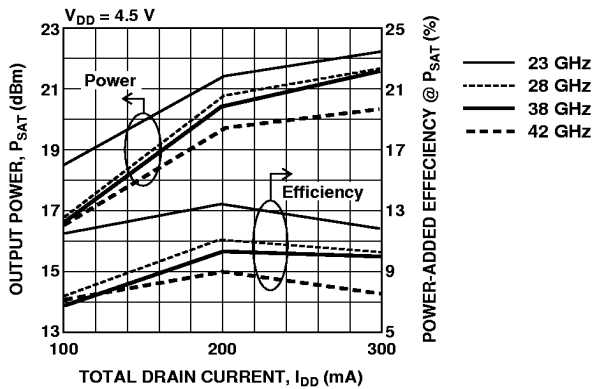

Figure 8. Output Power^[1] and Efficiency vs. Drain Current with $V_{DD} = 4.5$ V.

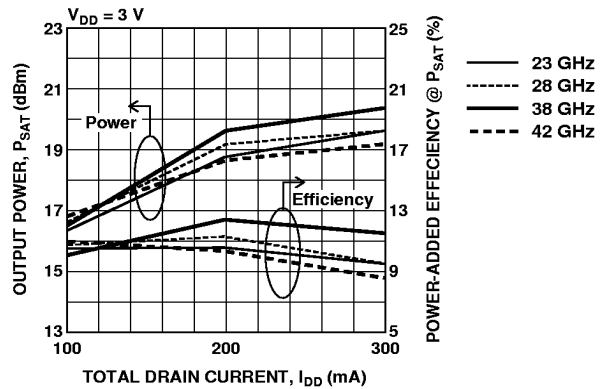

Figure 9. Output Power^[1] and Efficiency vs. Drain Current with $V_{DD} = 3$ V.

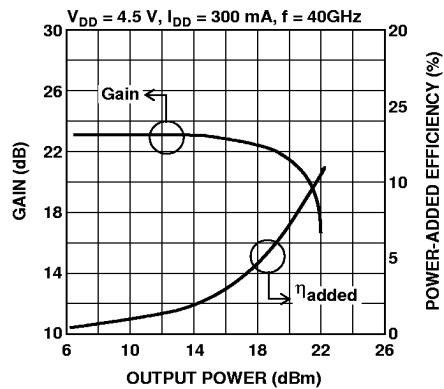

Figure 10. Gain Compression and Efficiency Characteristics.^[2]

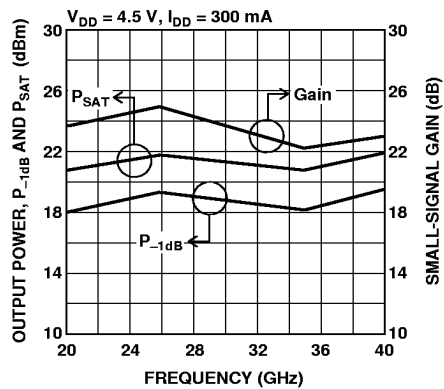

Figure 11. Output Power and Gain vs. Frequency Characteristics.^[2]

Notes:

1. Output power into 50 Ω with 2 dBm input power. Wafer-probed measurements.
2. Wafer-probed measurements.
3. Measurements taken on a device mounted in a connectorized package calibrated at the connector terminals.

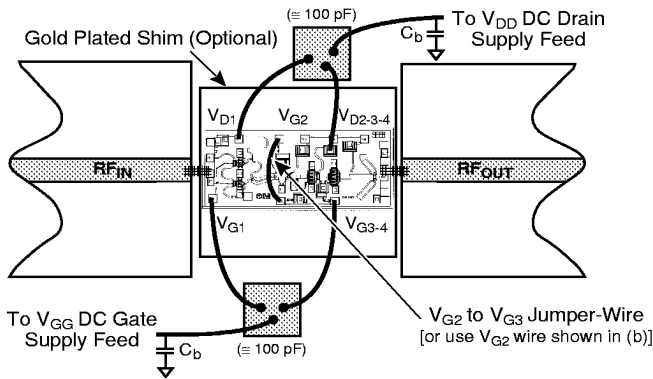

Figure 12a. Single drain and single gate supply assembly for tripler and standard amplifier applications.

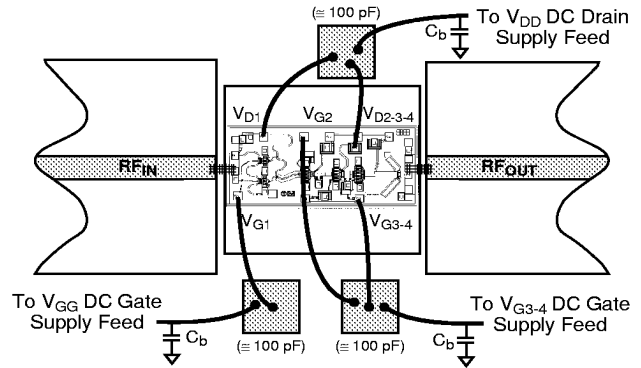

Figure 12b. Separate first-stage gate bias supply for any multiplier or amplifier application. This diagram shows an optional variation to the V_{G2} jumper-wire bonding scheme presented in (a).

Figure 12. HMMC-5040 Common Assembly Diagrams.

(Note: To assure stable operation, bias supply feeds should be bypassed to ground with a capacitor, $C_b > 100$ nF typical.)

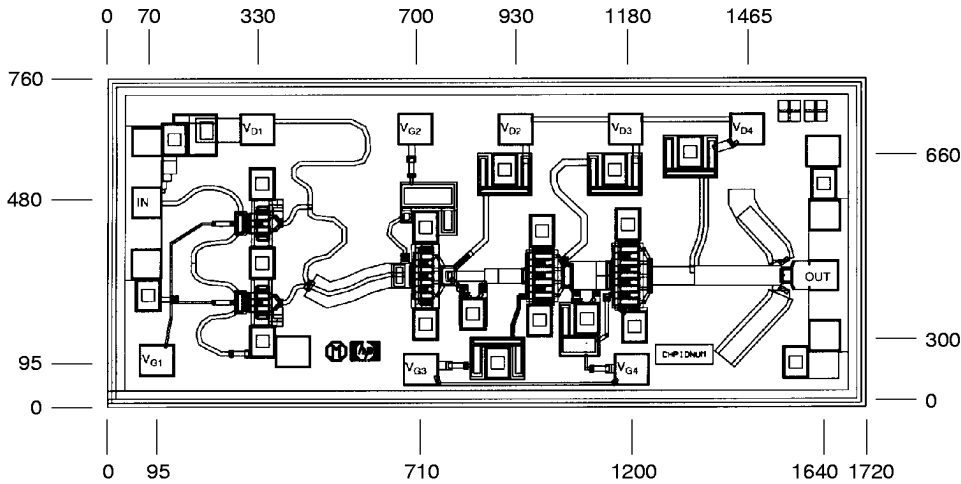

Figure 13. HMMC-5040 Bonding Pad Locations. (Dimensions in micrometers)

This data sheet contains a variety of typical and guaranteed performance data. The information supplied should not be interpreted as a complete list of circuit specifications. In this data sheet the term *typical* refers to the 50th percentile performance. For additional information contact your local HP sales representative.