

DATA SHEET

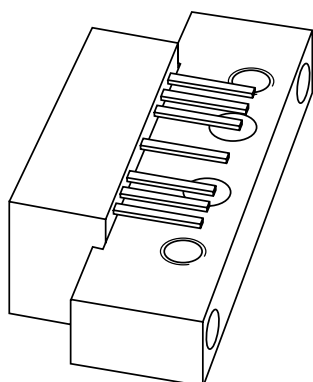

BGD906; BGD906MI 860 MHz, 21.5 dB gain power doubler amplifier

Product specification
Supersedes data of 2000 Mar 28

2001 Nov 01

860 MHz, 21.5 dB gain power doubler amplifier BGD906; BGD906MI

FEATURES

- Excellent linearity
- Extremely low noise
- Excellent return loss properties
- Silicon nitride passivation
- Rugged construction
- Gold metallization ensures excellent reliability.

APPLICATIONS

- CATV systems operating in the 40 to 900 MHz frequency range.

DESCRIPTION

Hybrid amplifier modules in a SOT115J package operating with a voltage supply of 24 V (DC). Both modules are electrically identical, only the pinning is different.

PINNING - SOT115J

PIN	DESCRIPTION	
	BGD906	BGD906MI
1	input	output
2, 3	common	common
5	+V _B	+V _B
7, 8	common	common
9	output	input

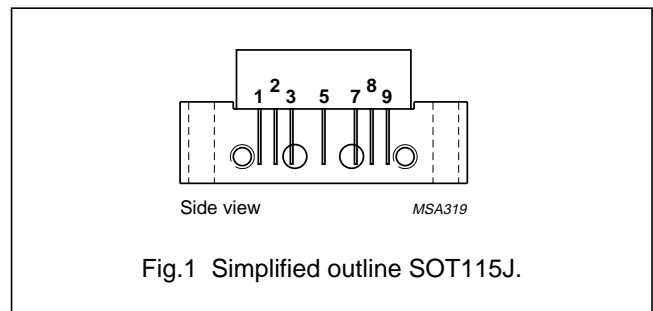

QUICK REFERENCE DATA

SYMBOL	PARAMETER	CONDITIONS	MIN.	MAX.	UNIT
G _p	power gain	f = 50 MHz	21.2	21.8	dB
		f = 900 MHz	22	23	dB
I _{tot}	total current consumption (DC)	V _B = 24 V; T _{mb} = 35 °C	405	435	mA

LIMITING VALUES

In accordance with the Absolute Maximum Rating System (IEC 60134).

SYMBOL	PARAMETER	MIN.	MAX.	UNIT
V _B	supply voltage	-	30	V
V _i	RF input voltage	-	70	dBmV
T _{stg}	storage temperature	-40	+100	°C
T _{mb}	operating mounting base temperature	-20	+100	°C

860 MHz, 21.5 dB gain power doubler amplifier

BGD906; BGD906MI

CHARACTERISTICSBandwidth 40 to 900 MHz; $V_B = 24$ V; $T_{mb} = 35$ °C; $Z_S = Z_L = 75$ Ω

SYMBOL	PARAMETER	CONDITIONS	MIN.	TYP.	MAX.	UNIT
G _p	power gain	f = 50 MHz	21.2	21.5	21.8	dB
		f = 900 MHz	22	22.5	23	dB
SL	slope straight line	f = 40 to 900 MHz	0.5	1	1.5	dB
FL	flatness straight line	f = 40 to 900 MHz	–	–	±0.35	dB
S ₁₁	input return losses	f = 40 to 80 MHz	22	25	–	dB
		f = 80 to 160 MHz	21	24	–	dB
		f = 160 to 320 MHz	18	23	–	dB
		f = 320 to 550 MHz	17	23	–	dB
		f = 550 to 900 MHz	16	20	–	dB
S ₂₂	output return losses	f = 40 to 80 MHz	22	25	–	dB
		f = 80 to 160 MHz	21	25	–	dB
		f = 160 to 320 MHz	20	23	–	dB
		f = 320 to 550 MHz	19	22	–	dB
		f = 550 to 650 MHz	18	24	–	dB
		f = 650 to 750 MHz	17	23	–	dB
		f = 750 to 900 MHz	16	21	–	dB
S ₂₁	phase response	f = 50 MHz	–45	–	+45	deg
CTB	composite triple beat	49 chs flat; V _o = 47 dBmV; f _m = 859.25 MHz	–	–68.5	–66	dB
		77 chs flat; V _o = 44 dBmV; f _m = 547.25 MHz	–	–70	–67	dB
		110 chs flat; V _o = 44 dBmV; f _m = 745.25 MHz	–	–63	–61	dB
		129 chs flat; V _o = 44 dBmV; f _m = 859.25 MHz	–	–59	–57	dB
		110 chs; f _m = 397.25 MHz; V _o = 49 dBmV at 550 MHz; note 1	–	–62.5	–60.5	dB
		129 chs; f _m = 697.25 MHz; V _o = 49.5 dBmV at 860 MHz; note 2	–	–57	–54.5	dB
X _{mod}	cross modulation	49 chs flat; V _o = 47 dBmV; f _m = 55.25 MHz	–	–64	–62	dB
		77 chs flat; V _o = 44 dBmV; f _m = 55.25 MHz	–	–67.5	–65	dB
		110 chs flat; V _o = 44 dBmV; f _m = 55.25 MHz	–	–64	–61.5	dB
		129 chs flat; V _o = 44 dBmV; f _m = 55.25 MHz	–	–61	–60	dB
		110 chs; f _m = 397.25 MHz; V _o = 49 dBmV at 550 MHz; note 1	–	–60	–58	dB
		129 chs; f _m = 859.25 MHz; V _o = 49.5 dBmV at 860 MHz; note 2	–	–56.5	–55	dB

860 MHz, 21.5 dB gain power doubler amplifier

BGD906; BGD906MI

SYMBOL	PARAMETER	CONDITIONS	MIN.	TYP.	MAX.	UNIT
CSO	composite second order distortion	49 chs flat; $V_o = 47$ dBmV; $f_m = 860.5$ MHz	–	–63	–59	dB
		77 chs flat; $V_o = 44$ dBmV; $f_m = 548.5$ MHz	–	–74	–65	dB
		110 chs flat; $V_o = 44$ dBmV; $f_m = 746.5$ MHz	–	–66	–58	dB
		129 chs flat; $V_o = 44$ dBmV; $f_m = 860.5$ MHz	–	–59	–54	dB
		110 chs; $f_m = 150$ MHz; $V_o = 49$ dBmV at 550 MHz; note 1	–	–64	–60	dB
		129 chs; $f_m = 150$ MHz; $V_o = 49.5$ dBmV at 860 MHz; note 2	–	–60	–54	dB
d_2	second order distortion	note 3	–	–83	–70	dB
		note 4	–	–81.5	–73	dB
		note 5	–	–79	–76	dB
V_o	output voltage	$d_{im} = -60$ dB; note 6	63.5	64.5	–	dBmV
		$d_{im} = -60$ dB; note 7	64.5	66.5	–	dBmV
		$d_{im} = -60$ dB; note 8	66.5	69	–	dBmV
		CTB compression = 1 dB; 129 chs flat; $f = 859.25$ MHz	48.5	49	–	dBmV
		CSO compression = 1 dB; 129 chs flat; $f = 860.5$ MHz	51	54	–	dBmV
NF	noise figure	$f = 50$ MHz	–	5	5.5	dB
		$f = 550$ MHz	–	4.5	5	dB
		$f = 750$ MHz	–	5	6	dB
		$f = 900$ MHz	–	6	7.5	dB
I_{tot}	total current consumption (DC)	note 9	405	420	435	mA

Notes

- Tilt = 9 dB (50 to 550 MHz)
tilt = 3.5 dB at –6 dB offset (550 to 750 MHz).
- Tilt = 12.5 dB (50 to 860 MHz).
- $f_p = 55.25$ MHz; $V_p = 44$ dBmV;
 $f_q = 805.25$ MHz; $V_q = 44$ dBmV;
measured at $f_p + f_q = 860.5$ MHz.
- $f_p = 55.25$ MHz; $V_p = 44$ dBmV;
 $f_q = 691.25$ MHz; $V_q = 44$ dBmV;
measured at $f_p + f_q = 746.5$ MHz.
- $f_p = 55.25$ MHz; $V_p = 44$ dBmV;
 $f_q = 493.25$ MHz; $V_q = 44$ dBmV;
measured at $f_p + f_q = 548.5$ MHz.
- Measured according to DIN45004B:
 $f_p = 851.25$ MHz; $V_p = V_o$;
 $f_q = 858.25$ MHz; $V_q = V_o - 6$ dB;
 $f_r = 860.25$ MHz; $V_r = V_o - 6$ dB;
measured at $f_p + f_q - f_r = 849.25$ MHz.
- Measured according to DIN45004B:
 $f_p = 740.25$ MHz; $V_p = V_o$;
 $f_q = 747.25$ MHz; $V_q = V_o - 6$ dB;
 $f_r = 749.25$ MHz; $V_r = V_o - 6$ dB;
measured at $f_p + f_q - f_r = 738.25$ MHz.
- Measured according to DIN45004B:
 $f_p = 540.25$ MHz; $V_p = V_o$;
 $f_q = 547.25$ MHz; $V_q = V_o - 6$ dB;
 $f_r = 549.25$ MHz; $V_r = V_o - 6$ dB;
measured at $f_p + f_q - f_r = 538.25$ MHz.
- The module normally operates at $V_B = 24$ V, but is able to withstand supply transients up to 35 V.

860 MHz, 21.5 dB gain power doubler amplifier

BGD906; BGD906MI

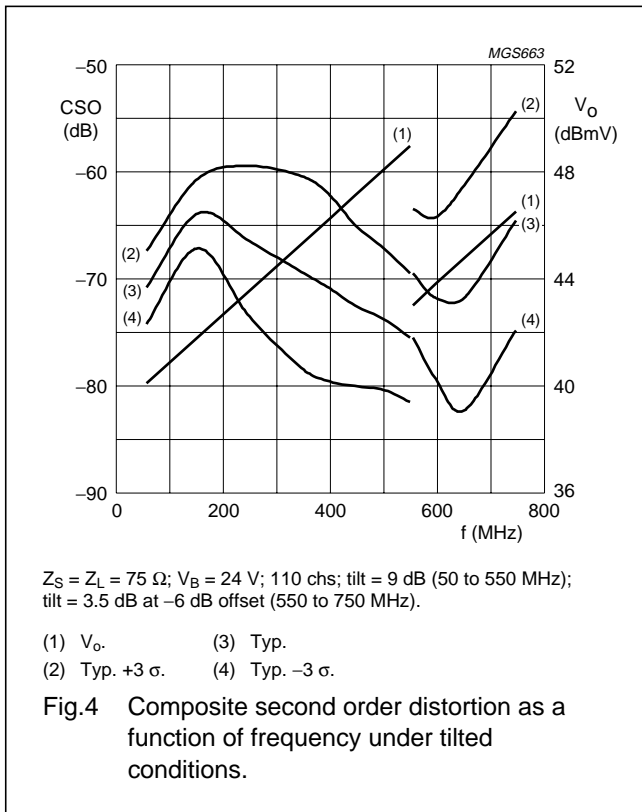
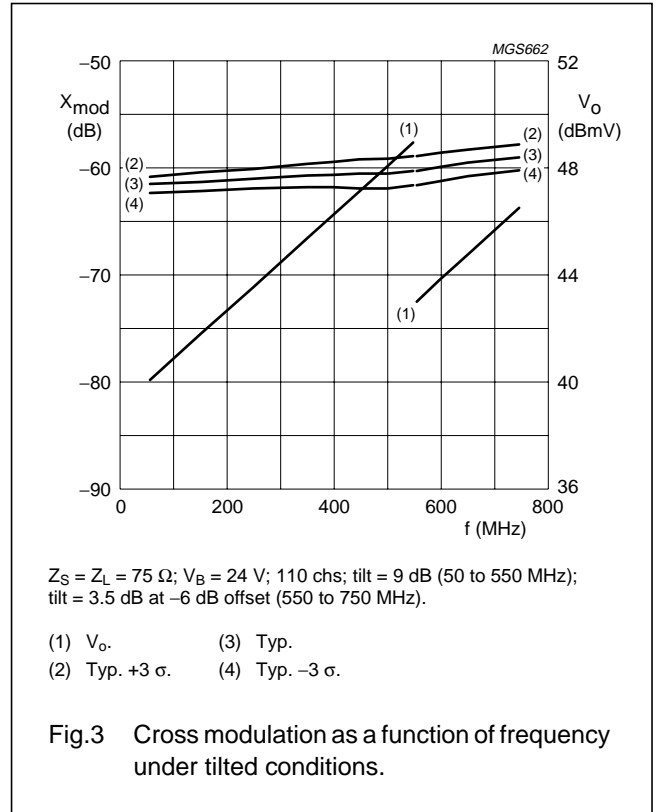
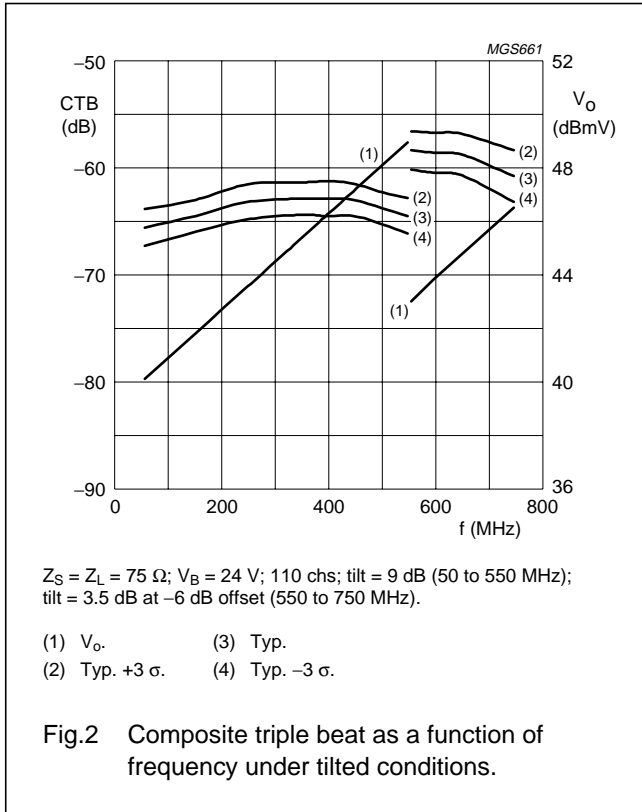

860 MHz, 21.5 dB gain power doubler amplifier

BGD906; BGD906MI

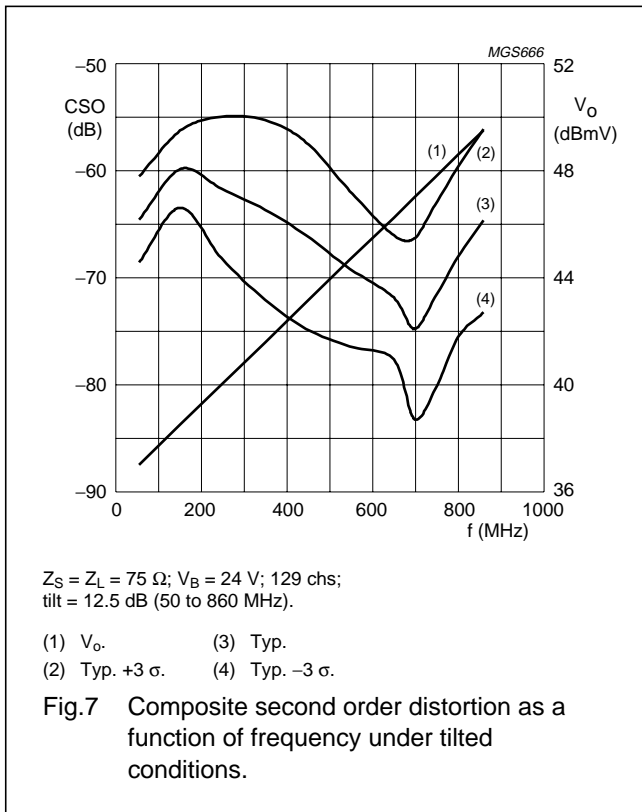
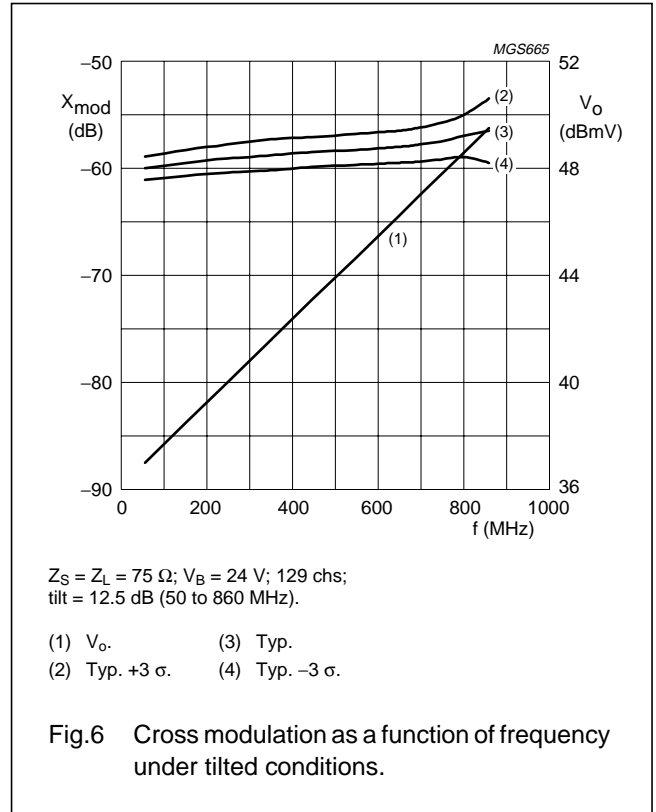
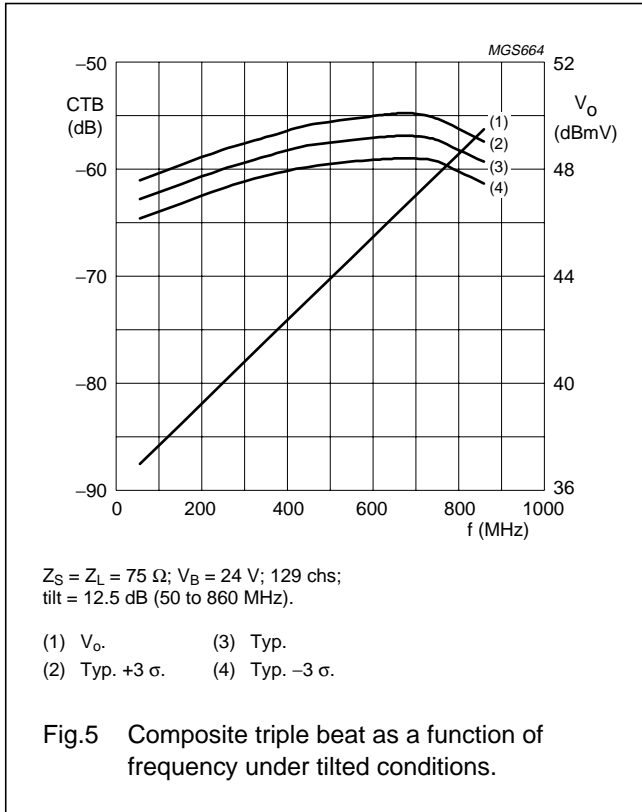

860 MHz, 21.5 dB gain power doubler amplifier

BGD906; BGD906MI

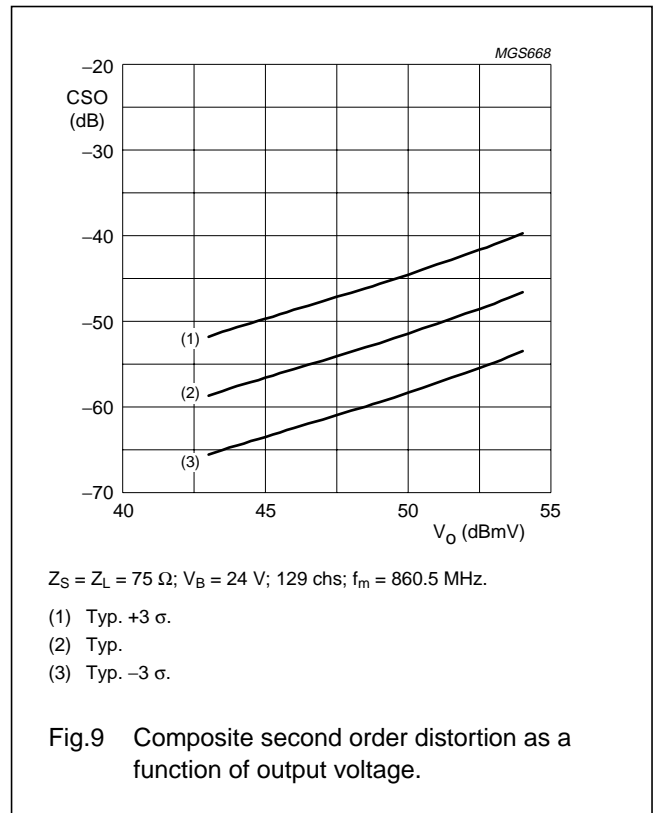
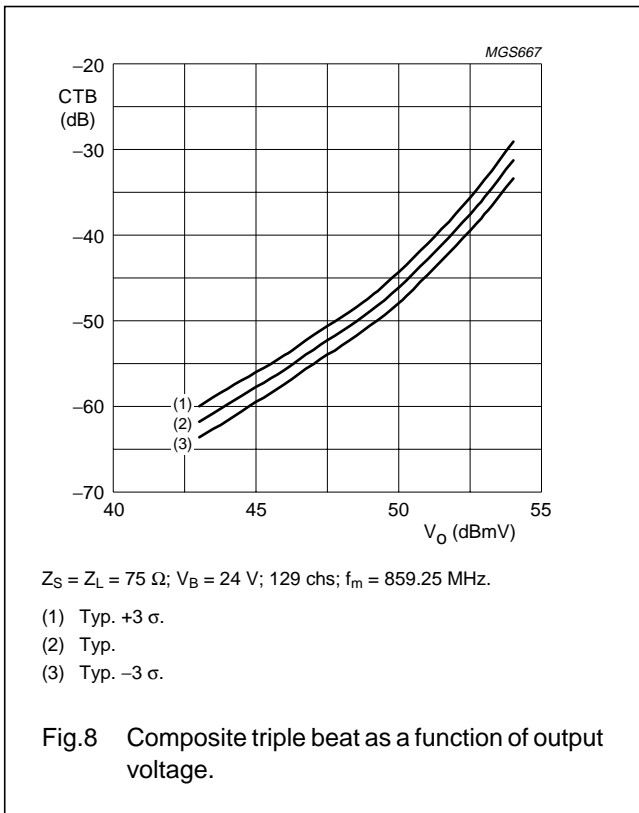

860 MHz, 21.5 dB gain power doubler amplifier

BGD906; BGD906MI

PACKAGE OUTLINE

Rectangular single-ended package; aluminium flange; 2 vertical mounting holes; 2 x 6-32 UNC and 2 extra horizontal mounting holes; 7 gold-plated in-line leads

SOT115J

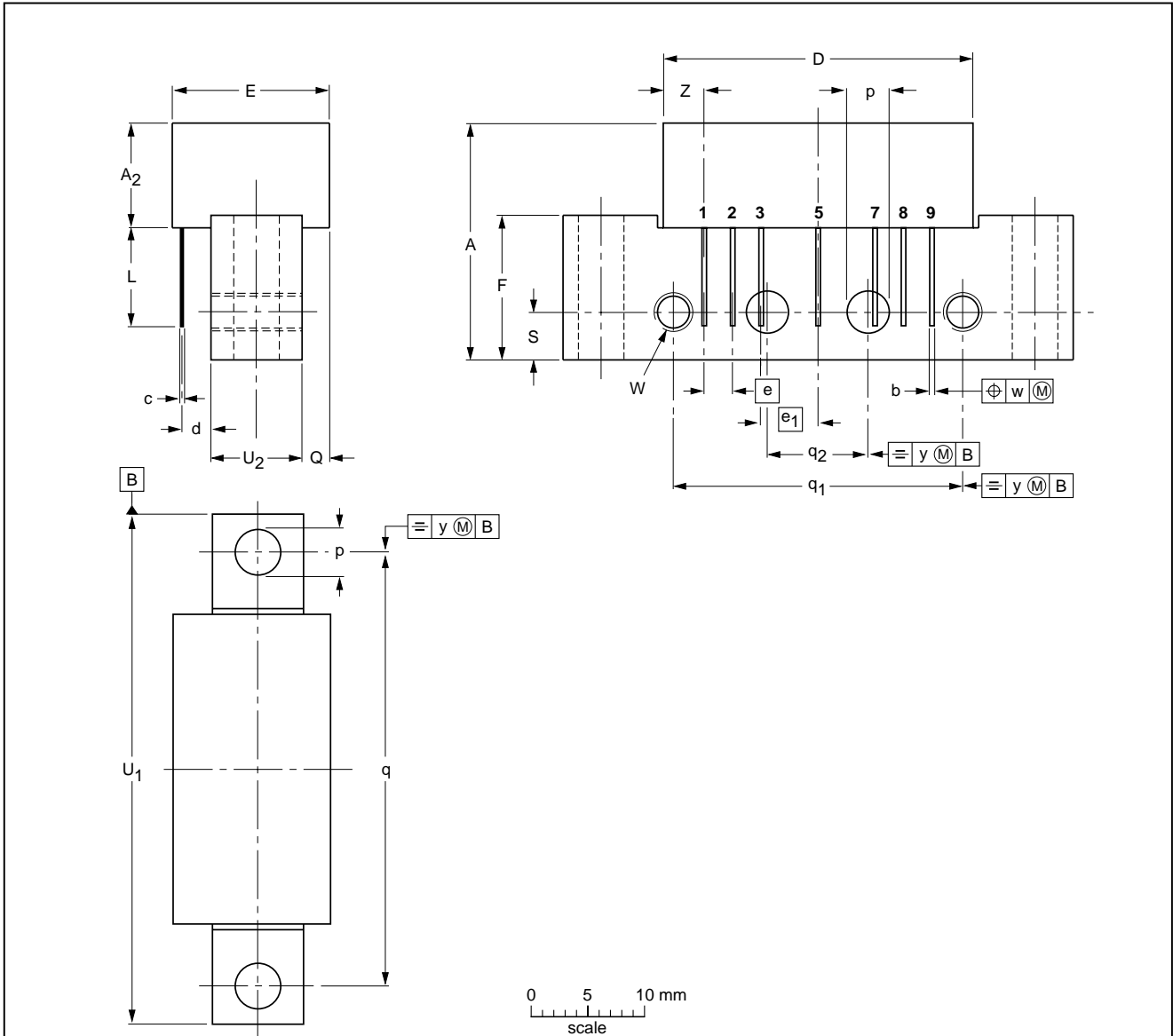

DIMENSIONS (mm are the original dimensions)

UNIT	A max.	A ₂ max.	b	c	D max.	d max.	E max.	e	e ₁	F	L min.	p	Q max.	q	q ₁	q ₂	S	U ₁ max.	U ₂	W	w	y	Z max.
mm	20.8	9.1	0.51 0.38	0.25	27.2	2.54	13.75	2.54	5.08	12.7	8.8	4.15 3.85	2.4	38.1	25.4	10.2	4.2	44.75	8	6-32 UNC	0.25	0.1	3.8

OUTLINE VERSION	REFERENCES				EUROPEAN PROJECTION	ISSUE DATE
	IEC	JEDEC	EIAJ			
SOT115J						99-02-06

860 MHz, 21.5 dB gain power doubler amplifier

BGD906; BGD906MI

DATA SHEET STATUS

DATA SHEET STATUS ⁽¹⁾	PRODUCT STATUS ⁽²⁾	DEFINITIONS
Objective data	Development	This data sheet contains data from the objective specification for product development. Philips Semiconductors reserves the right to change the specification in any manner without notice.
Preliminary data	Qualification	This data sheet contains data from the preliminary specification. Supplementary data will be published at a later date. Philips Semiconductors reserves the right to change the specification without notice, in order to improve the design and supply the best possible product.
Product data	Production	This data sheet contains data from the product specification. Philips Semiconductors reserves the right to make changes at any time in order to improve the design, manufacturing and supply. Changes will be communicated according to the Customer Product/Process Change Notification (CPCN) procedure SNW-SQ-650A.

Notes

1. Please consult the most recently issued data sheet before initiating or completing a design.
2. The product status of the device(s) described in this data sheet may have changed since this data sheet was published. The latest information is available on the Internet at URL <http://www.semiconductors.philips.com>.

DEFINITIONS

Short-form specification — The data in a short-form specification is extracted from a full data sheet with the same type number and title. For detailed information see the relevant data sheet or data handbook.

Limiting values definition — Limiting values given are in accordance with the Absolute Maximum Rating System (IEC 60134). Stress above one or more of the limiting values may cause permanent damage to the device. These are stress ratings only and operation of the device at these or at any other conditions above those given in the Characteristics sections of the specification is not implied. Exposure to limiting values for extended periods may affect device reliability.

Application information — Applications that are described herein for any of these products are for illustrative purposes only. Philips Semiconductors make no representation or warranty that such applications will be suitable for the specified use without further testing or modification.

DISCLAIMERS

Life support applications — These products are not designed for use in life support appliances, devices, or systems where malfunction of these products can reasonably be expected to result in personal injury. Philips Semiconductors customers using or selling these products for use in such applications do so at their own risk and agree to fully indemnify Philips Semiconductors for any damages resulting from such application.

Right to make changes — Philips Semiconductors reserves the right to make changes, without notice, in the products, including circuits, standard cells, and/or software, described or contained herein in order to improve design and/or performance. Philips Semiconductors assumes no responsibility or liability for the use of any of these products, conveys no licence or title under any patent, copyright, or mask work right to these products, and makes no representations or warranties that these products are free from patent, copyright, or mask work right infringement, unless otherwise specified.

860 MHz, 21.5 dB gain power doubler amplifier

BGD906; BGD906MI

NOTES

860 MHz, 21.5 dB gain power doubler amplifier

BGD906; BGD906MI

NOTES

Philips Semiconductors – a worldwide company

Contact information

For additional information please visit <http://www.semiconductors.philips.com>. Fax: +31 40 27 24825

For sales offices addresses send e-mail to: sales.addresses@www.semiconductors.philips.com.

© Koninklijke Philips Electronics N.V. 2001

SCA73

All rights are reserved. Reproduction in whole or in part is prohibited without the prior written consent of the copyright owner.

The information presented in this document does not form part of any quotation or contract, is believed to be accurate and reliable and may be changed without notice. No liability will be accepted by the publisher for any consequence of its use. Publication thereof does not convey nor imply any license under patent- or other industrial or intellectual property rights.

Printed in The Netherlands

613518/04/pp12

Date of release: 2001 Nov 01

Document order number: 9397 750 08863

Let's make things better.

**Philips
Semiconductors**



PHILIPS