

## Product Description

Sirenza Microdevices' SGA-1263 is a Silicon Germanium HBT Heterostructure Bipolar Transistor (SiGe HBT) amplifier that offers excellent isolation and flat gain response for applications to 4 GHz.

This RFIC is a 2-stage design that provides high isolation of up to 40dB at 2 GHz and is fabricated using the latest SiGe HBT 50 GHz  $F_T$  process, featuring 1 micron emitters with  $V_{ceo} > 7V$ .

These unconditionally stable amplifiers have less than 1dB gain drift over 125°C operating range (-40C to +85C) and are ideal for use as buffer amplifiers in oscillator applications covering cellular, ISM and narrowband PCS bands.

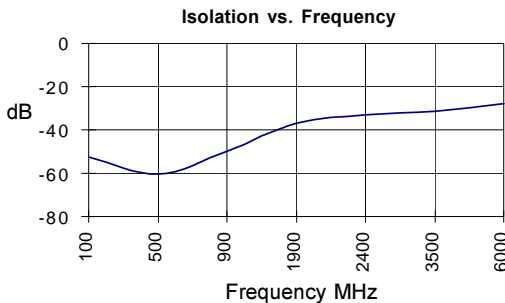

## SGA-1263

### DC-4000 MHz Silicon Germanium HBT Cascadeable Gain Block



### Product Features

- DC-4000 MHz Operation
- Single Supply Voltage
- Excellent Isolation, >50 dB at 900 MHz
- 50 Ohms In/Out, Broadband Match for Operation from DC-4 GHz
- Unconditionally Stable

### Applications

- Buffer Amplifier for Oscillator Applications
- Broadband Gain Blocks
- IF Amp

Symbol	Parameters: Test Conditions: $Z_0 = 50 \text{ Ohms}$ , $I_d = 8 \text{ mA}$ , $T = 25^\circ\text{C}$		Units	Min.	Typ.	Max.
$P_{1dB}$	Output Power at 1dB Compression	$f = 850 \text{ MHz}$ $f = 1950 \text{ MHz}$	dBm dBm		-7.8 -7.4	
$S_{21}$	Small Signal Gain	$f = \text{DC} - 1000 \text{ MHz}$ $f = 1000 - 2000 \text{ MHz}$ $f = 2000 - 4000 \text{ MHz}$	dB dB dB	14.3	15.9 15.2 12.3	
$S_{12}$	Reverse Isolation	$f = \text{DC} - 1000 \text{ MHz}$ $f = 1000 - 2000 \text{ MHz}$ $f = 2000 - 4000 \text{ MHz}$	dB dB dB		56.3 40.6 30.8	
$S_{11}$	Input VSWR	$f = \text{DC} - 2400 \text{ MHz}$ $f = 2400 - 4000 \text{ MHz}$	-		1.8:1 1.3:1	
$S_{22}$	Output VSWR	$f = \text{DC} - 2400 \text{ MHz}$ $f = 2400 - 4000 \text{ MHz}$	-		1.8:1 1.9:1	
$IP_3$	Third Order Intercept Point Power out per Tone = -20 dBm	$f = 850 \text{ MHz}$ $f = 1950 \text{ MHz}$	dBm dBm		2.6 2.8	
NF	Noise Figure	$f = \text{DC} - 1000 \text{ MHz}$ $f = 1000 - 2400 \text{ MHz}$	dB dB		2.7 2.9	
$T_D$	Group Delay	$f = 1000 \text{ MHz}$	pS		82	
$V_D$	Device Operating Voltage		V	2.5	2.8	3.1
$I_D$	Device Operating Current		mA	6	8	10

The information provided herein is believed to be reliable at press time. Sirenza Microdevices assumes no responsibility for inaccuracies or omissions. Sirenza Microdevices assumes no responsibility for the use of this information, and all such information shall be entirely at the user's own risk. Prices and specifications are subject to change without notice. No patent rights or licenses to any of the circuits described herein are implied or granted to any third party. Sirenza Microdevices does not authorize or warrant any Sirenza Microdevices product for use in life-support devices and/or systems. Copyright 2001 Sirenza Microdevices, Inc. All worldwide rights reserved.

Parameter	Specification				Test Condition
	Min	Typ.	Max.	Unit	
<b>Bandwidth</b> Frequency Range	DC		4000	MHz	T= 25C
<b>Device Bias</b> Operating Voltage Operating Current		2.8 8		V mA	T= 25C
<b>500 MHz</b> Gain Noise Figure Output IP3 Output P1dB Input Return Loss Isolation		16.0 2.7 4.0 -6.9 8.5 61.6		dB dB dBm dBm dB dB	T= 25C
<b>850 MHz</b> Gain Noise Figure Output IP3 Output P1dB Input Return Loss Isolation		15.7 2.7 2.6 -7.8 8.9 48.4		dB dB dBm dBm dB dB	T= 25C
<b>1950 MHz</b> Gain Noise Figure Output IP3 Output P1dB Input Return Loss Isolation		14.7 3.0 2.8 -7.4 8.8 35.6		dB dB dBm dBm dB dB	T= 25C
<b>2400 MHz</b> Gain Noise Figure Output IP3 Output P1dB Input Return Loss Isolation		14.2 2.8 0.2 -7.0 8.4 33.6		dB dB dBm dBm dB dB	T= 25C

### Absolute Maximum Ratings

Parameter	Absolute Limit
Max. Device Current ( $I_b$ )	20 mA
Max. Device Voltage ( $V_D$ )	5 V
Max. RF Input Power	-12 dBm
Max. Junction Temp. ( $T_J$ )	+150°C
Operating Temp. Range ( $T_L$ )	-40°C to +85°C
Max. Storage Temp.	+150°C

Operation of this device beyond any one of these limits may cause permanent damage. For reliable continuous operation, the device voltage and current must not exceed the maximum operating values specified in the table on page one.

Bias conditions should also satisfy the following expression:  

$$I_b V_D < (T_J - T_L) / R_{TH, J}$$

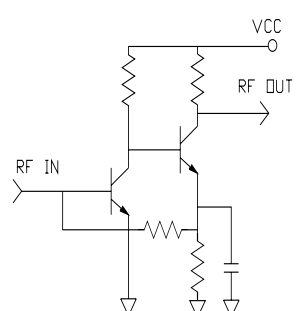
Pin #	Function	Description	Device Schematic
1	GND	Connection to ground. Use via holes for best performance to reduce lead inductance as close to ground leads as possible.	
2	GND	Sames as Pin 1	
3	RF IN	RF input pin. This pin requires the use of an external DC blocking capacitor chosen for the frequency of operation.	
4	Vcc	Supply Connection. This pin should be bypassed with a suitable capacitor(s).	
5	GND	Sames as Pin 1	
6	RF OUT	RF output and bias pin. DC voltage is present on this pin, therefore a DC blocking capacitor is necessary for proper operation.	

### Application Schematic for +5V Operation at 900 MHz

**Note: A bias resistor is needed for stability over temperature**

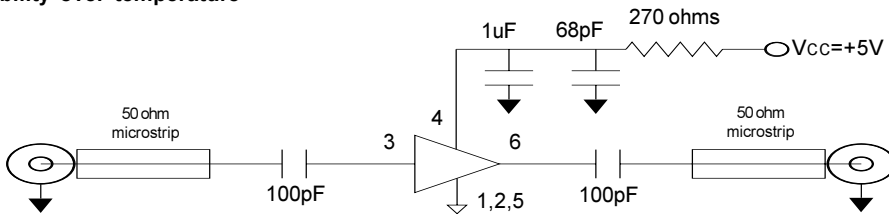

### Application Schematic for +5V Operation at 1900 MHz

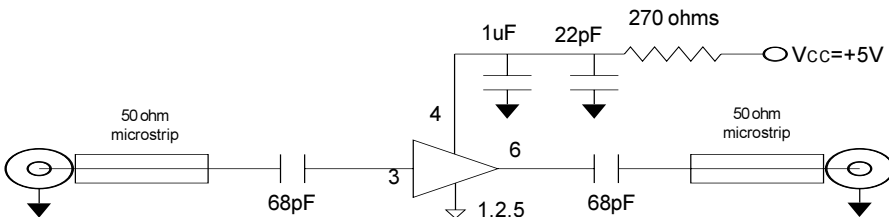

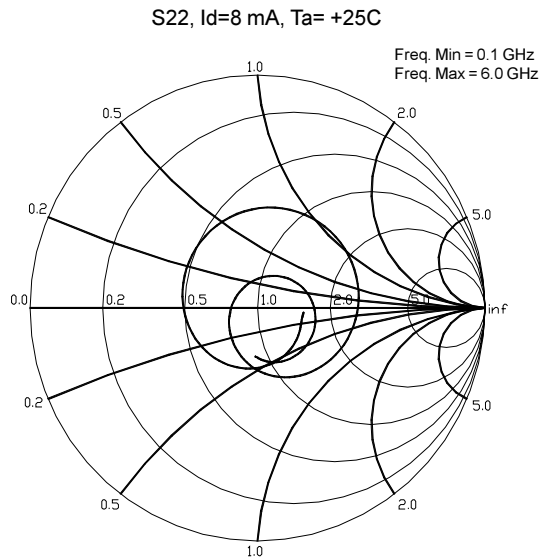
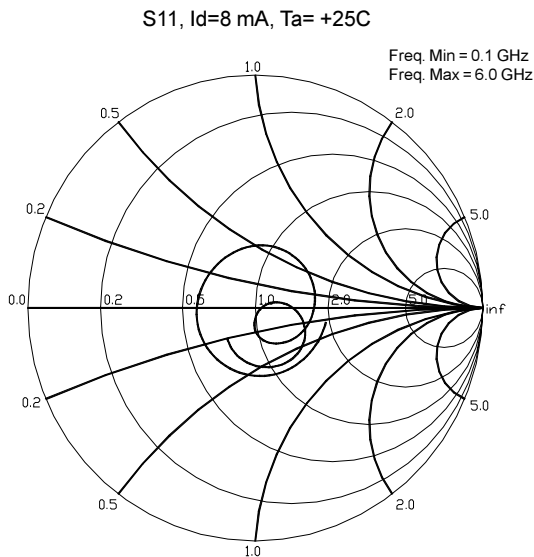
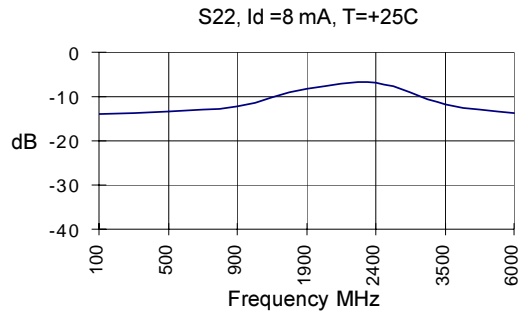
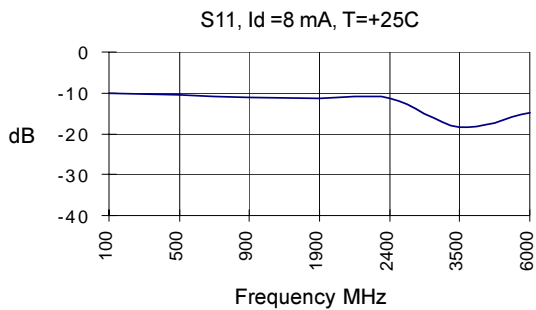
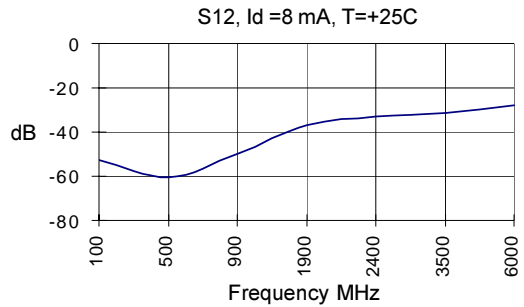
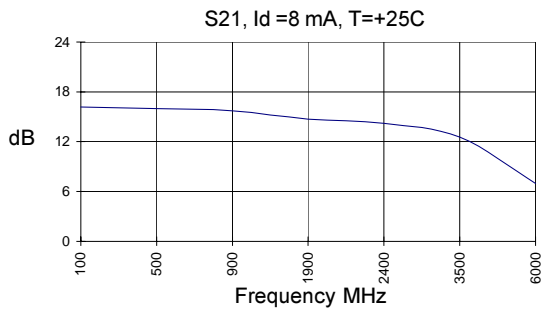

S21, Id=8 mA, T=-40C

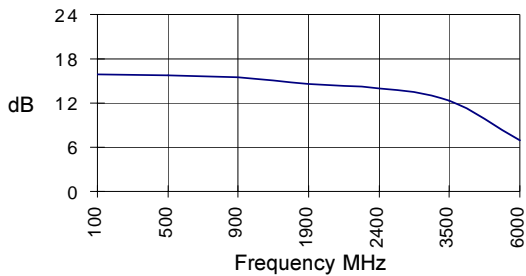

S12, Id=8 mA, T=-40C

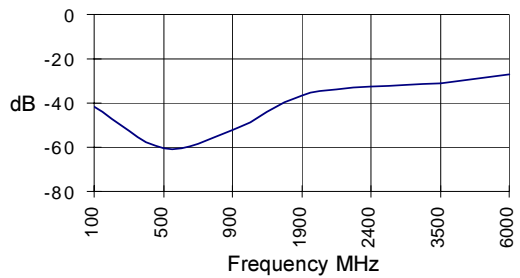

S11, Id=8 mA, T=-40C

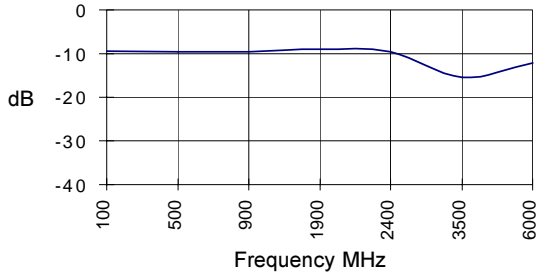

S22, Id=8 mA, T=-40C

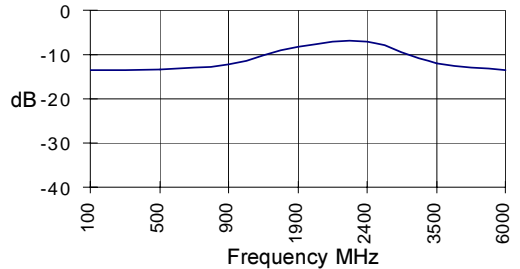

S11, Id=8 mA, T=-40C

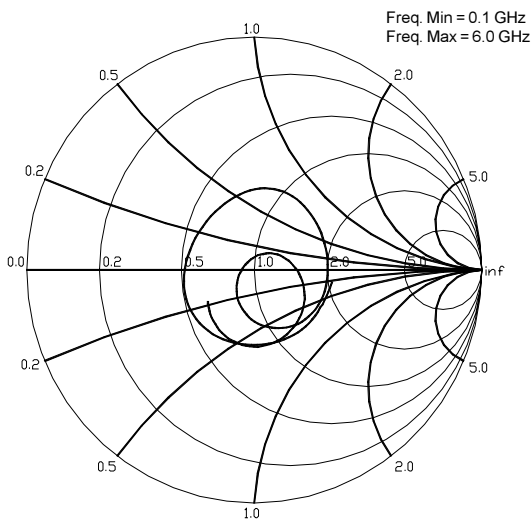

S22, Id=8 mA, T=-40C

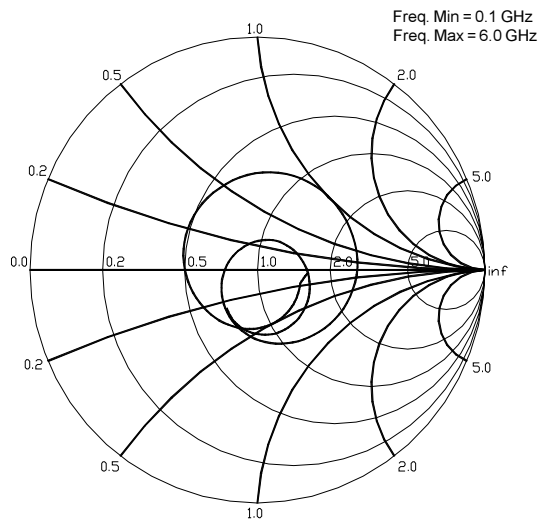

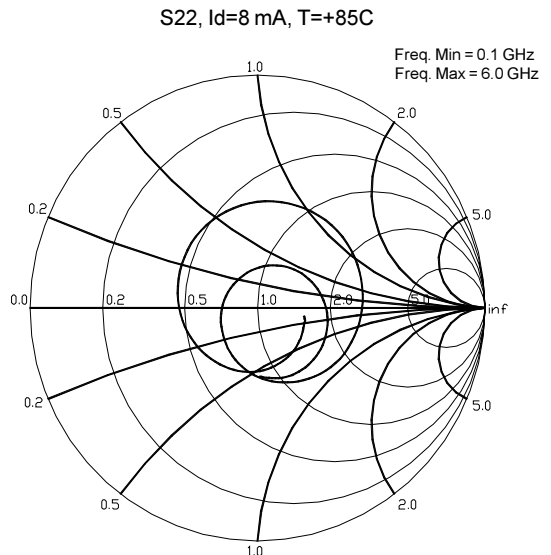
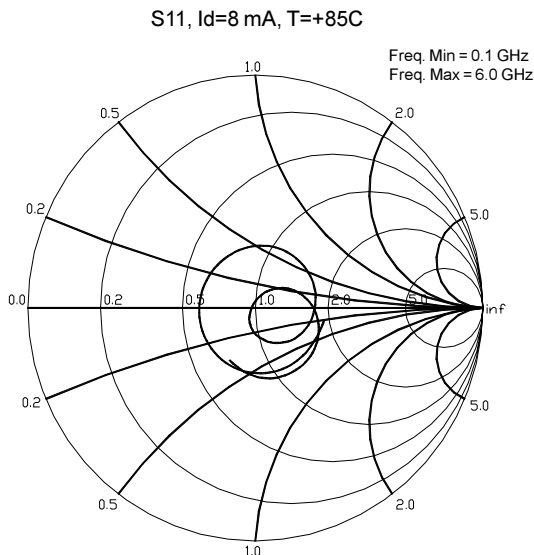
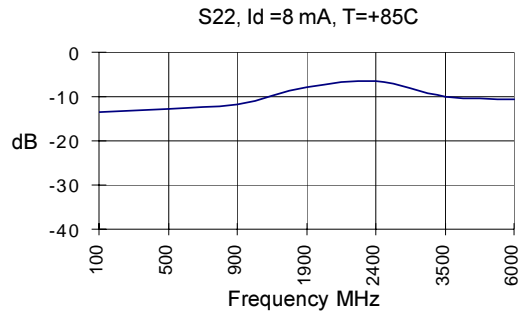
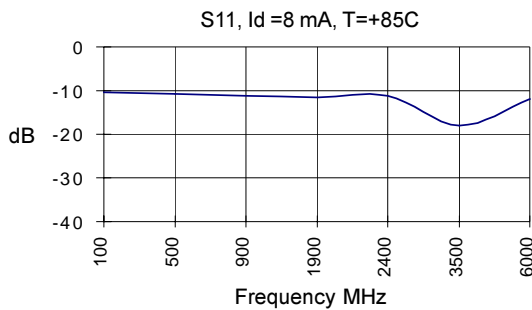
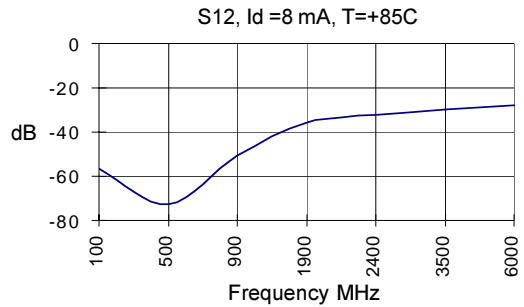
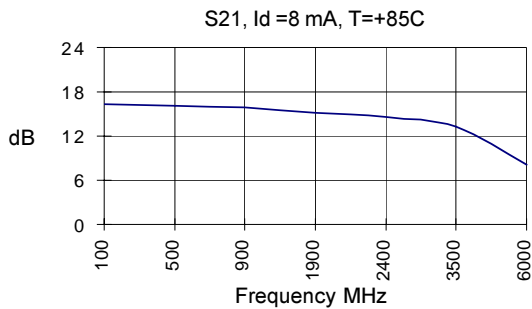

### Absolute Maximum Ratings

### Part Number Ordering Information

Part Number	Reel Size	Devices/Reel
SGA-1263-TR1	7"	3000

### Caution:



Operation of this device above any one of these parameters may cause permanent damage. Appropriate precautions in handling, packaging and testing devices must be observed.

Recommended Bias Resistor Values					
Supply Voltage (Vs)	3.6V	5V	7.5V	9V	12V
Rbias (Ohms)	100	275	588	775	1150

Thermal Resistance (Lead-Junction):  
255° C/W

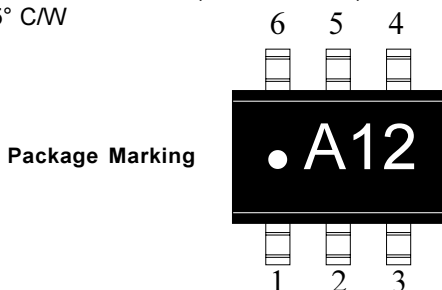

Pin Designation	
1	GND
2	GND
3	RF in
4	Vcc
5	GND
6	RF out

Note: Pin 1 is on lower left when you can read package marking

### Package Dimensions

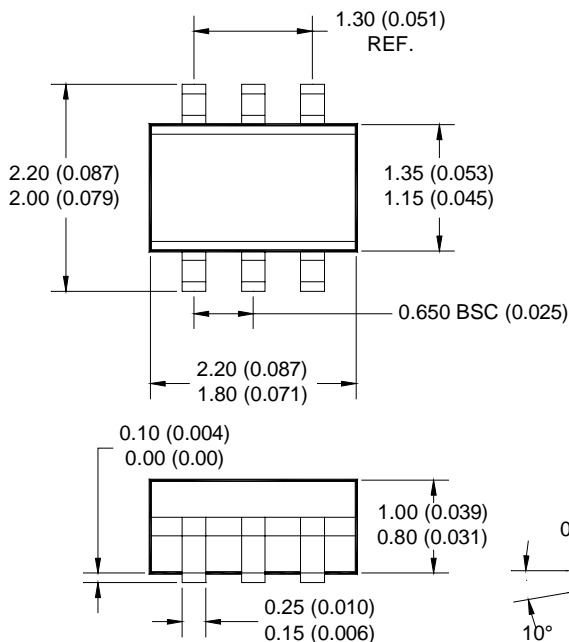

### Pad Layout

