

# Rectifier diodes schottky barrier

# PBYR3045PT series

## GENERAL DESCRIPTION

Dual, low leakage, platinum barrier, schottky rectifier diodes in a plastic envelope featuring low forward voltage drop and absence of stored charge. These devices can withstand reverse voltage transients and have guaranteed reverse surge capability. The devices are intended for use in switched mode power supplies and high frequency circuits in general where low conduction and zero switching losses are important.

## QUICK REFERENCE DATA

SYMBOL	PARAMETER	MAX.	MAX.	MAX.	UNIT
$V_{RRM}$	<b>PBYR30-</b> Repetitive peak reverse voltage Forward voltage Output current (both diodes conducting)	<b>35PT</b> 35	<b>40PT</b> 40	<b>45PT</b> 45	V
$V_F$		0.60	0.60	0.60	V
$I_{O(AV)}$		30	30	30	A

## PINNING - SOT93

PIN	DESCRIPTION
1	Anode 1 (a)
2	Cathode (k)
3	Anode 2 (a)
tab	Cathode (k)

## PIN CONFIGURATION

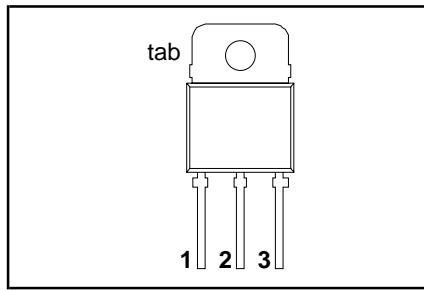

## SYMBOL

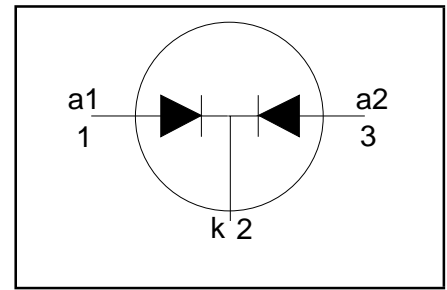

## LIMITING VALUES

Limiting values in accordance with the Absolute Maximum System (IEC 134).

SYMBOL	PARAMETER	CONDITIONS	MIN.	MAX.			UNIT
				-35	-40	-45	
$V_{RRM}$	Repetitive peak reverse voltage		-	35	40	45	V
$V_{RWM}$	Crest working reverse voltage		-	35	40	45	V
$V_R$	Continuous reverse voltage	$T_{mb} \leq 136\text{ }^\circ\text{C}$	-	35	40	45	V
$I_{O(AV)}$	Output current (both diodes conducting) <sup>1</sup>	square wave; $\delta = 0.5$ ; $T_{mb} \leq 130\text{ }^\circ\text{C}$	-	30			A
$I_{O(RMS)}$	RMS forward current		-	43			A
$I_{FRM}$	Repetitive peak forward current per diode	$t = 25\text{ }\mu\text{s}$ ; $\delta = 0.5$ ; $T_{mb} \leq 130\text{ }^\circ\text{C}$	-	30			A
$I_{FSM}$	Non-repetitive peak forward current per diode	$t = 10\text{ ms}$	-	180			A
		$t = 8.3\text{ ms}$	-	200			A
$I^2t$	$I^2t$ for fusing	$V_{RWM(max)}$	-	162			A <sup>2</sup> s
		$t = 10\text{ ms}$	-	2			A
$I_{RRM}$	Repetitive peak reverse current per diode.	$t_p = 2\text{ }\mu\text{s}$ ; $\delta = 0.001$	-	2			A
$I_{RSM}$	Non-repetitive peak reverse current per diode.	$t_p = 100\text{ }\mu\text{s}$	-	2			A
$T_{stg}$	Storage temperature		-65	175			$^\circ\text{C}$
$T_j$	Operating junction temperature		-	150			$^\circ\text{C}$

<sup>1</sup> For output currents in excess of 20 A connection should be made to the exposed metal mounting base.

---

**Rectifier diodes  
schottky barrier**

---

**PBYR3045PT series****THERMAL RESISTANCES**

SYMBOL	PARAMETER	CONDITIONS	MIN.	TYP.	MAX.	UNIT
$R_{th\ j-mb}$	Thermal resistance junction to mounting base	per diode	-	-	1.4	K/W
$R_{th\ j-a}$	Thermal resistance junction to ambient	both diodes in free air.	-	-	1.0	K/W
			-	45	-	K/W

**STATIC CHARACTERISTICS** $T_j = 25\text{ °C}$  unless otherwise stated

SYMBOL	PARAMETER	CONDITIONS	MIN.	TYP.	MAX.	UNIT
$V_F$	Forward voltage (per diode)	$I_F = 20\text{ A}; T_j = 125\text{ °C}$	-	0.55	0.60	V
		$I_F = 30\text{ A}; T_j = 125\text{ °C}$	-	0.67	0.72	V
		$I_F = 30\text{ A}$	-	0.71	0.76	
$I_R$	Reverse current (per diode)	$V_R = V_{RWM}$	-	100	200	$\mu\text{A}$
		$V_R = V_{RWM}; T_j = 125\text{ °C}$	-	12	40	$\text{mA}$
$C_d$	Junction capacitance (per diode)	$f = 1\text{ MHz}; V_R = 5\text{ V}; T_j = 25\text{ °C to } 125\text{ °C}$	-	800	-	$\text{pF}$

Rectifier diodes  
schottky barrier

PBYR3045PT series

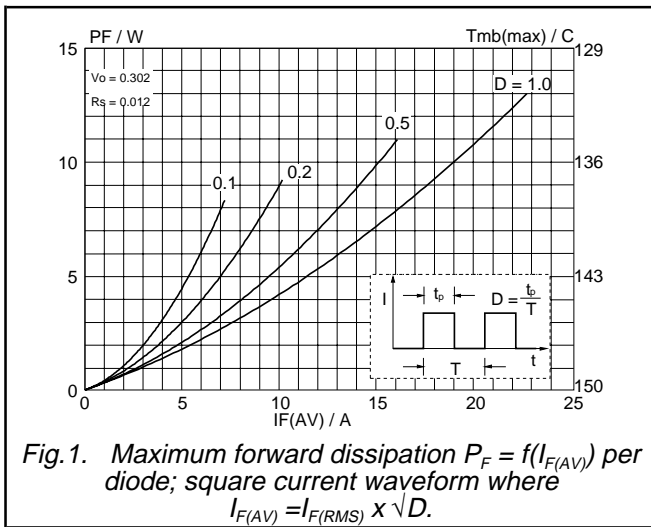

Fig.1. Maximum forward dissipation  $P_F = f(I_{F(AV)})$  per diode; square current waveform where  $I_{F(AV)} = I_{F(RMS)} \times \sqrt{D}$ .

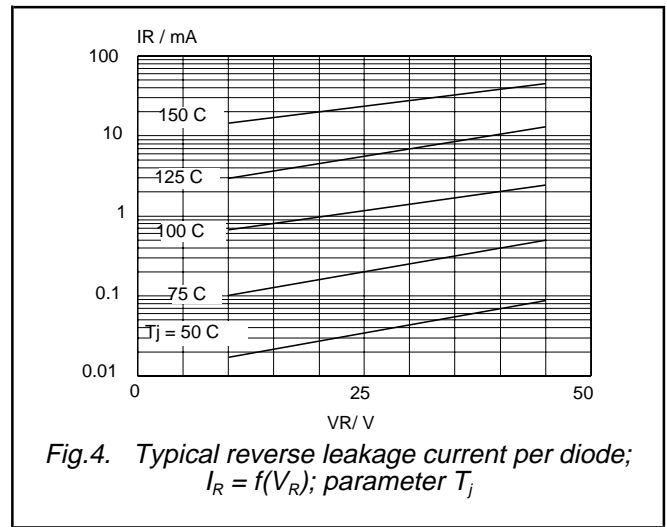

Fig.4. Typical reverse leakage current per diode;  $I_R = f(V_R)$ ; parameter  $T_j$

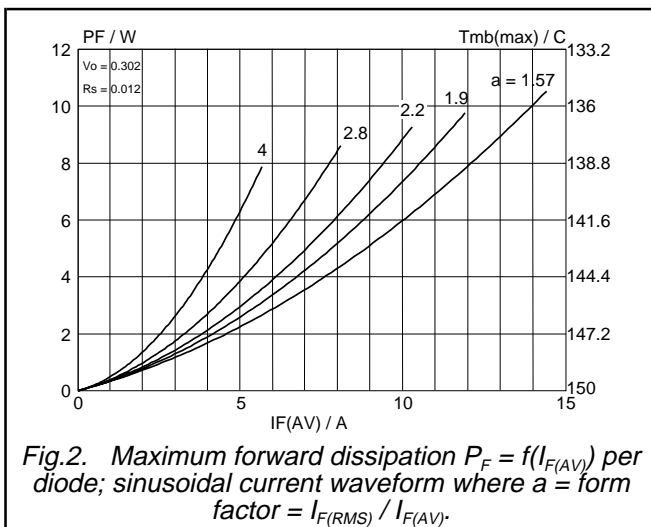

Fig.2. Maximum forward dissipation  $P_F = f(I_{F(AV)})$  per diode; sinusoidal current waveform where  $a =$  form factor  $= \frac{I_{F(RMS)}}{I_{F(AV)}}$ .

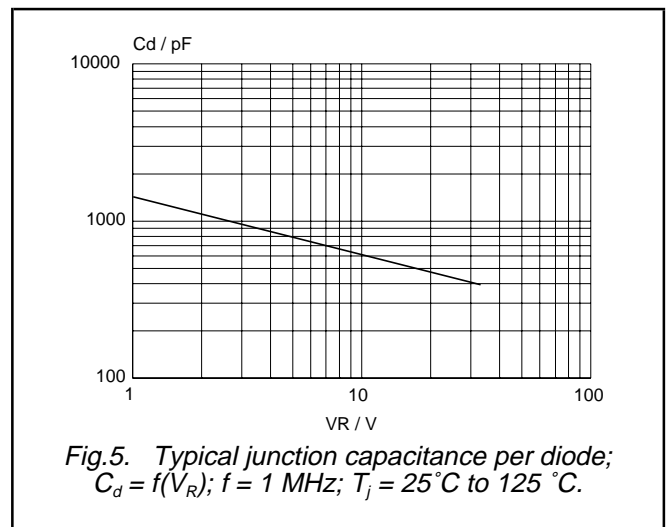

Fig.5. Typical junction capacitance per diode;  $C_d = f(V_R)$ ;  $f = 1$  MHz;  $T_j = 25$  °C to 125 °C.

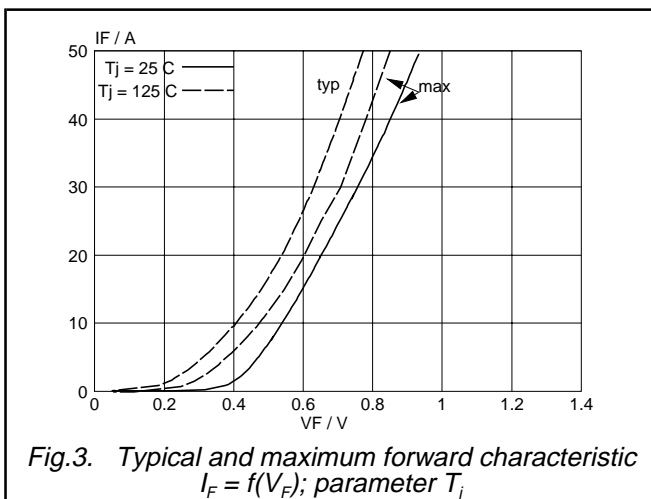

Fig.3. Typical and maximum forward characteristic  $I_F = f(V_F)$ ; parameter  $T_j$

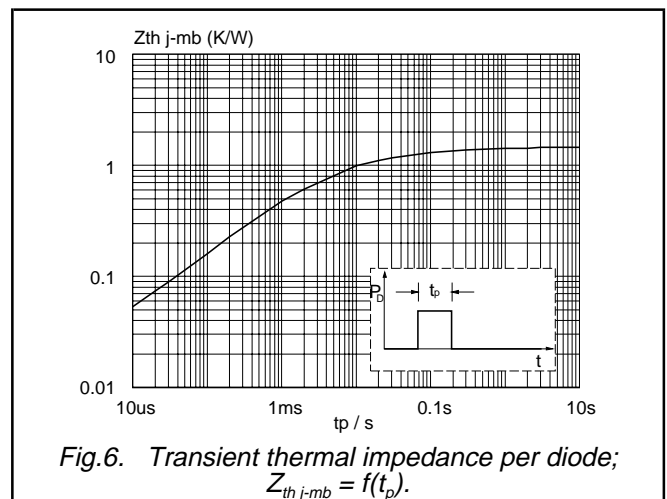
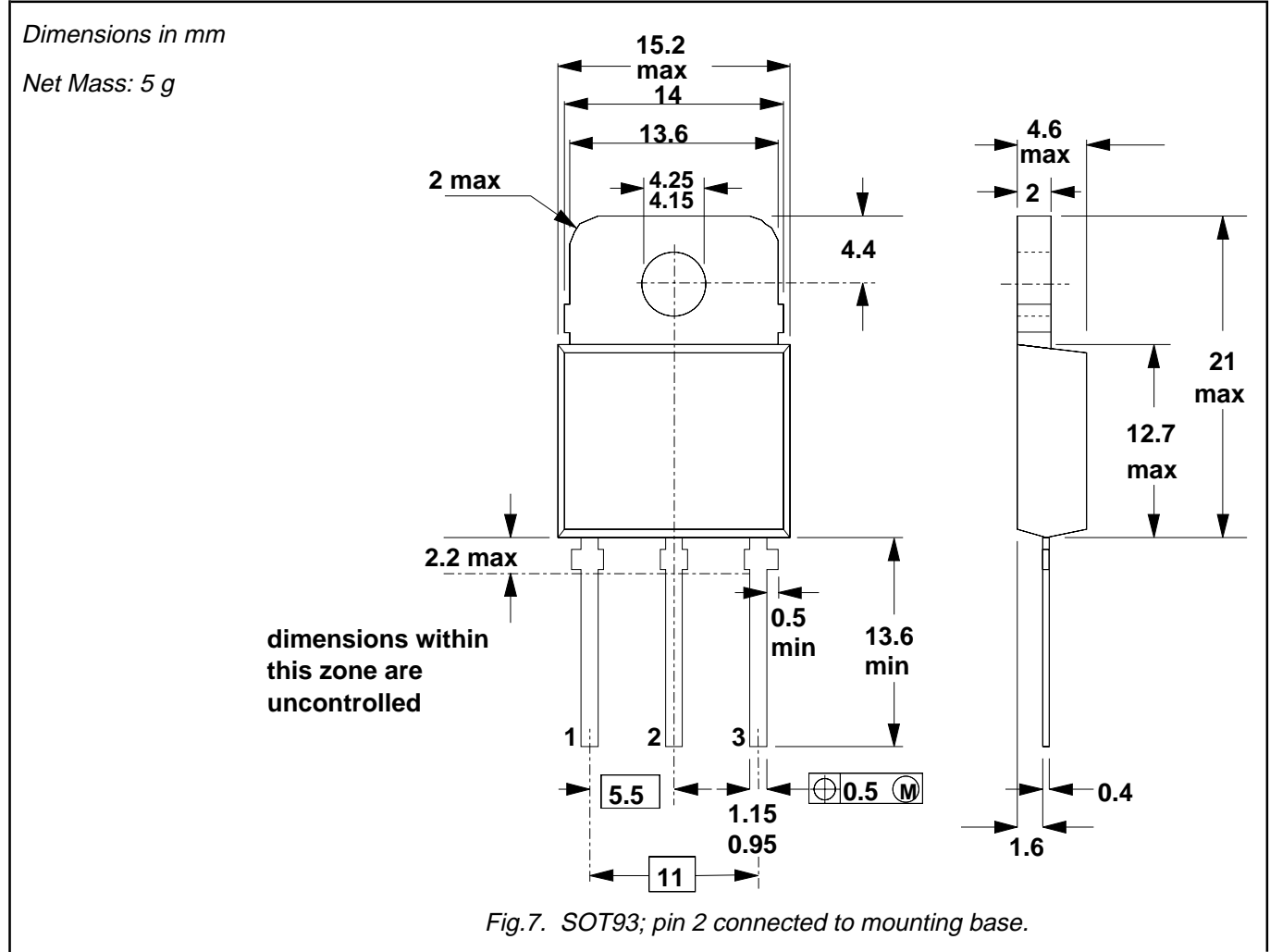

Fig.6. Transient thermal impedance per diode;  $Z_{th j-mb} = f(t_p)$ .

Rectifier diodes  
schottky barrier

PBYR3045PT series

**MECHANICAL DATA**



**Notes**

- 1. Refer to mounting instructions for SOT93 envelope.
- 2. Epoxy meets UL94 V0 at 1/8".

---

**Rectifier diodes  
schottky barrier**

---

**PBYR3045PT series**

---

**DEFINITIONS**

<b>Data sheet status</b>	
Objective specification	This data sheet contains target or goal specifications for product development.
Preliminary specification	This data sheet contains preliminary data; supplementary data may be published later.
Product specification	This data sheet contains final product specifications.
<b>Limiting values</b>	
Limiting values are given in accordance with the Absolute Maximum Rating System (IEC 134). Stress above one or more of the limiting values may cause permanent damage to the device. These are stress ratings only and operation of the device at these or at any other conditions above those given in the Characteristics sections of this specification is not implied. Exposure to limiting values for extended periods may affect device reliability.	
<b>Application information</b>	
Where application information is given, it is advisory and does not form part of the specification.	
<b>© Philips Electronics N.V. 1996</b>	
All rights are reserved. Reproduction in whole or in part is prohibited without the prior written consent of the copyright owner.	
The information presented in this document does not form part of any quotation or contract, it is believed to be accurate and reliable and may be changed without notice. No liability will be accepted by the publisher for any consequence of its use. Publication thereof does not convey nor imply any license under patent or other industrial or intellectual property rights.	

**LIFE SUPPORT APPLICATIONS**

These products are not designed for use in life support appliances, devices or systems where malfunction of these products can be reasonably expected to result in personal injury. Philips customers using or selling these products for use in such applications do so at their own risk and agree to fully indemnify Philips for any damages resulting from such improper use or sale.