

M62244FP

Li-ion Battery Charge Controller IC

REJ03F0067-0100Z

Rev.1.0

Sep.19.2003

Description

M62244FP is a semiconductor integrated circuit designed as Li-ion battery charge control IC.

Built-in constant current and constant voltage circuit allows for charging Li-ion battery.

Features

- Available for 4.2V battery
- Built-in high precision ref. voltage (charge voltage) $4.2V \pm 30mV$
- Available for constant current and constant voltage charge
- Built-in protection function for charge prohibition of over-discharged battery
- Built-in protection function for charge prohibition of high and low temperature battery
- Built-in trickle charge function
- Charge condition displayed by 2 system LEDs
- Built-in delay circuit for chattering prevention
- Built-in charge OFF function when adaptor is pulled out
- Built-in charge OFF function when adaptor voltage goes down
- Charge ON/OFF available by external control
- Built-in 3 kind of timer (externally variable)
 - Initial setting timer : about 5 min.
 - Recharge timer : about a hour
 - Charge timer : about 4 hour
- Built-in LED blinking function when abnormal

Application

Li-ion battery charger

Pin Configuration

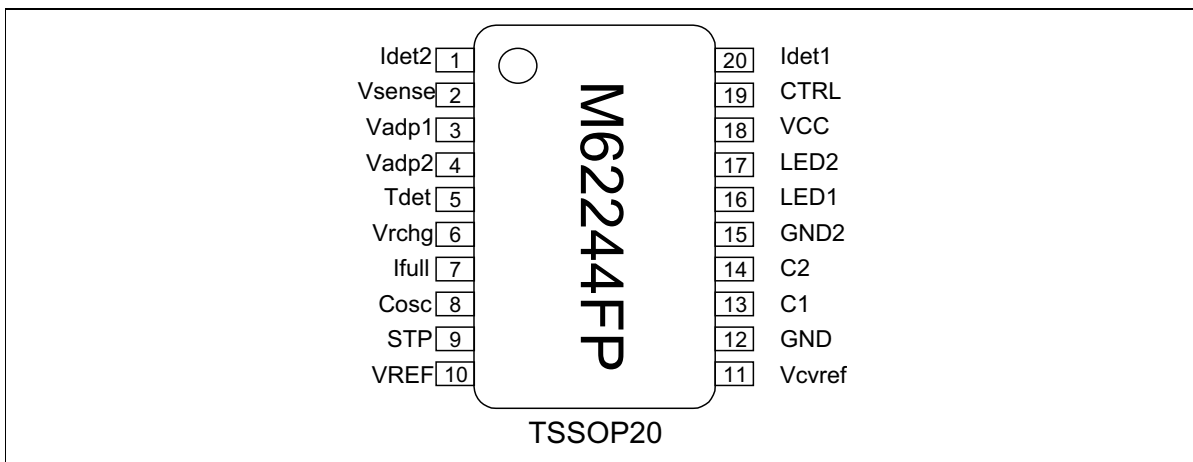

Description of pins

Pin No.	Pin name	I/O	Function	Protection diode	
				Positive	Negative
18	Vcc	—	Power-supply input	—	gnd1
16	LED1	O	LED drive	Vcc	gnd2
17	LED2	I/O	LED drive (with function for switching the LEDs' blinking period) The blinking period of LED1 is set to 0.6 Hz (typ.) by fixing this signal low.	Vcc	gnd2
15	GND2	—	Ground for power supply	—	—
9	STP	I	Forcible charge OFF H (or open): Charging possible, L: Charging stopped	Vcc	gnd1
8	COSC	—	For connection to the capacitor used to set the oscillator circuit's frequency	Vcc	gnd1
12	GND1	—	Ground	—	—
5	Tdet	I	Battery-temperature detection	Vcc	gnd1
10	Vref	O	Reference power-supply output	Vcc	gnd1
6	Vrchg	I	Adjustment of start-recharging voltage The pin voltage is set to 1.0 V (typ.). The voltage at which recharging starts (threshold) may be changed by using an external resistor etc. to adjust the voltage on this pin. The actual voltage is the voltage on this pin multiplied by 11.8 dB.	Vcc	gnd1
20	Idet1	I	Charging-current detection	—	gnd1
1	Idet2	I	The drop in voltage across an external resistor RS (connected between these pins) reflects the size of the charging current and is used to detect the completion of charging.		
2	Vsense	I/O	Battery-voltage detection Detects the battery-voltage value for use in charging control.	—	gnd1
7	Ifull	I	Charging-completed current switching Select the current taken as indicating the completion of charging by leaving this pin open or connecting it to ground. The charging-completed current is controlled by comparing the voltage on the Ifull pin with the level 12 dB above the voltage drop between Idet1 and Idet2.	Vcc	gnd1
13	C1	—	Compensation for the charge-control phase A capacitor between C1 and ground improves the stability of oscillation during charging at constant current and constant voltage.	Vcc	gnd1
14	C2	—	For connection of a capacitor that comes into play during switching of the charging current Reduces overshooting of the charging current when the charging current is switched.	Vcc	gnd1
19	CTRL	O	Output for charge control Controls the base (gate of a p-ch transistor) of an external pnp transistor so that constant-current or constant-voltage charging is applied.	—	gnd2
3	Vadp1	I	For adjusting the adapter-detection voltage 1 (detection voltage when charging has stopped) Pin-voltage is set to 1.0 V (typ.). The value to be taken as adapter-detection voltage 1 is controlled by using an external resistor etc. to adjust the voltage on this pin. The actual voltage is the voltage on this pin multiplied by 14.3.	Vcc	gnd1
4	Vadp2	I	For adjusting the adapter-detection voltage 2 (detection voltage during charging) Pin-voltage is set to 1.0 V (typ.). The value to be taken as adapter-detection voltage 2 is controlled by using an external resistor etc. to adjust the voltage on this pin. The actual voltage is the voltage on this pin multiplied by 13.9dB.	Vcc	gnd1
11	Vcvref	O	Reference voltage for constant-voltage control	Vcc	gnd1

Pin Description

No.	Pin name	Equivalent circuit	No.	Pin name	Equivalent circuit	No.	Pin name	Equivalent circuit
16	LED1		6	Vrchg		14	C2	
17	LED2		20	Idet1		19	CTRL	
9	STP		1	Idet2		3	Vadp1	
8	COSC		2	Vsense		4	Vadp2	
5	Tdet		7	Ifull		11	Vcvref	
10	Vref		13	C1				

Absolute maximum ratings

($T_a=25^{\circ}\text{C}$, unless otherwise noted)

Item	Symbol	Rating	Unit	Remarks
Max. applied voltage	V_{max}	7.0	V	
CTRL pin: drive current	I_{ctrl}	30	mA	
LED drive current	I_{led}	20	mA	
Vcvref pin: output current	I_{cvref}	-5	mA	
Allowable dissipation	P_d	800	mW	When mounted on a single-layered board (70 mm × 70 mm × 1.6 mm) (natural convection condition)
Thermal derating	$K\theta$	-8	mW/ $^{\circ}\text{C}$	
Operating temperature range	T_{opr}	-20 to +85	$^{\circ}\text{C}$	
Storage temperature range	T_{stg}	-40 to +125	$^{\circ}\text{C}$	

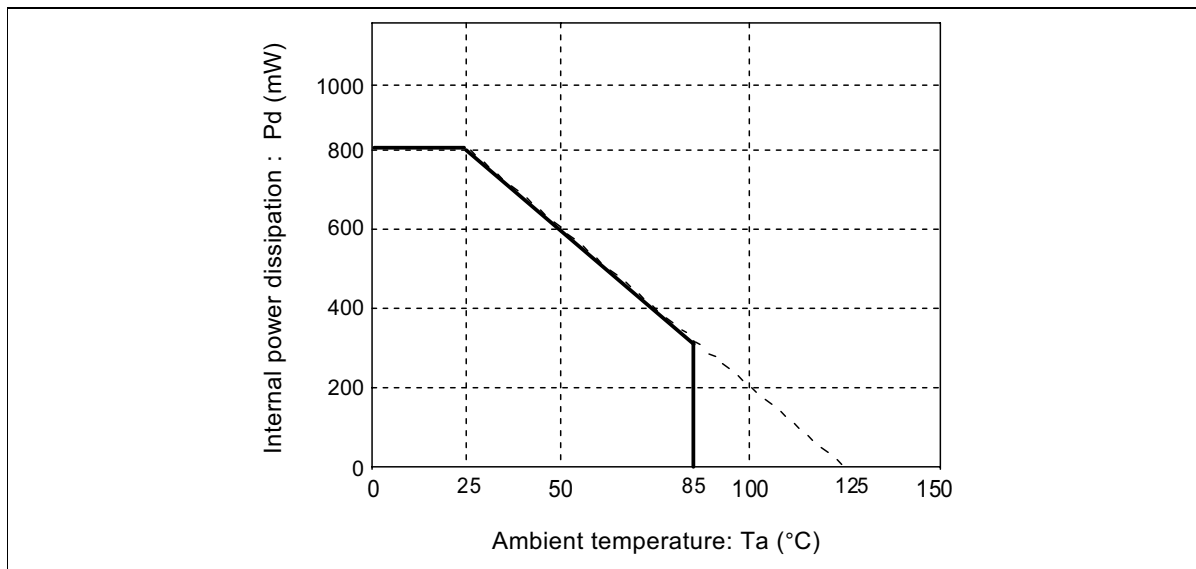

Figure 1 Thermal derating curve

Electrical Characteristics

Unless otherwise specified, Ta = 25°C, VCC = 5.5 V, resistor for current detection = 0.2 Ω, and pins for adjustment Vstrt, Vstp, Ifull, and Vrchg are open-circuit.)

Block	Item	Symbol	Rated value			Unit	Remarks	
			Min.	Typ.	Max.			
All	Power-supply voltage range for charge-control	VCC	3.0	5.5	6.5	V		
	Circuit current	Icc	—	—	5.0	mA	When not connected to a battery	
	Battery-discharge current (when not charging)	Ibatout	—	—	1.50	μA	Battery is discharged to the IC when VBAT = 4.2 V (through pins Idet1, Idet2, Vsense)	
	Reference voltage	Vref	1.176	1.200	1.224	V		
	Reference voltage for IL=-1mA	Vcvref1	2.076	2.100	2.124	V		
	constant-voltage control	Vcvref2	2.07	2.10	2.13	V		
Battery-voltage detector	Excessive-discharge detection voltage	Vlv	1.9	2.0	2.1	V	Precharge 2 start voltage	
	Hysteresis in excessive-discharge detection voltage	Vlvhis	25	50	75	mV		
	Fast-charge start voltage	Vfchg	2.8	2.9	3.0	V	Fast charge start voltage	
	Hysteresis in fast-charge start voltage	Vfchghis	250	300	350	mV		
	Recharge-start voltage	Vrchg	3.85	3.90	3.95	V	When no external resistor is connected to Vrchg. Selectable by an external resistor	
	Charging-completed voltage	Vfull	Vrchg +0.03	Vrchg +0.05	Vrchg +0.07	V	Hysteresis in the recharge-start voltage	
	Charge control voltage	Ta = 15 to 35°C	Vchg11	4.190	4.200	4.210	V	When Ichg = 130 mA (RS = 0.2 Ω). See note 1.
		Ta = 20 to 85°C	Vchg12	4.170	4.200	4.230	V	
		Ta = 15 to 35°C	Vchg21	4.187	4.200	4.213	V	When Ichg = 130 mA (RS = 0.2 Ω). See note 2.
		Ta = 20 to 85°C	Vchg22	4.167	4.200	4.233	V	
		Ta = 0 to 50°C	Vchg31	4.170	4.200	4.230	V	When Ichg = 130 mA (RS = 0.2 Ω), no external resistor
		Ta = 20 to 85°C	Vchg32	4.150	4.200	4.250	V	
	Excessive voltage detection	Vov	4.30	4.35	4.40	V		
Charging current detector	Precharge current 1	Ipre1	2	3	5	mA		
	Precharge current 2	Ipre2	10	20	30	mV	Voltage across Rs when VBAT = 2.6 V	
	Fast-charge current	Ichg	190	200	210	mV	Voltage across Rs when VBAT = 3.6 V	
	Charging-completed current	Ifullchg1	19	25	31	mV	Voltage across Rs when Ifull is open-circuit.	
		Ifullchg2	9	15	21	mV	Voltage across Rs when Ifull is connected to ground.	
	Excessive current detection	Ioc	250	300	350	mV		

Block	Item	Symbol	Rated value			Unit	Remarks
			Min.	Typ.	Max.		
Temperature detector	Battery temperature detection, cold end (-3°C)	Tth2	75.49 (-2.0°C)	76.67 (-3.5°C)	77.94 (-5.0°C)	%	Note 3
	Hysteresis at the cold end (at -5°C or equivalent)	Tthis2	10	20	30	mV	
	Battery temperature detection, hot-end 1 (43°C)	Tth3	33.11 (44.5°C)	34.23 (43°C)	35.43 (41.5°C)	%	See note 3
	Battery temperature detection, hot-end 2 (55°C)	Tth4	25.05 (56.5°C)	25.94 (55°C)	26.89 (53.5°C)	%	See note 3
Battery connection detector	Battery connection-detected voltage, low extreme	Vbc1	0.8	1.0	1.2	V	
	Battery connection-detected voltage, high extreme	Vbc2	3.9	4.0	4.1	V	
	Battery connection-detected current	lbc1	14	20	26	mV	Voltage across Rs when Ifull is open-circuit.
		lbc2	3	9	15	mV	Voltage across Rs when Ifull is connected to ground.

Flowcharts

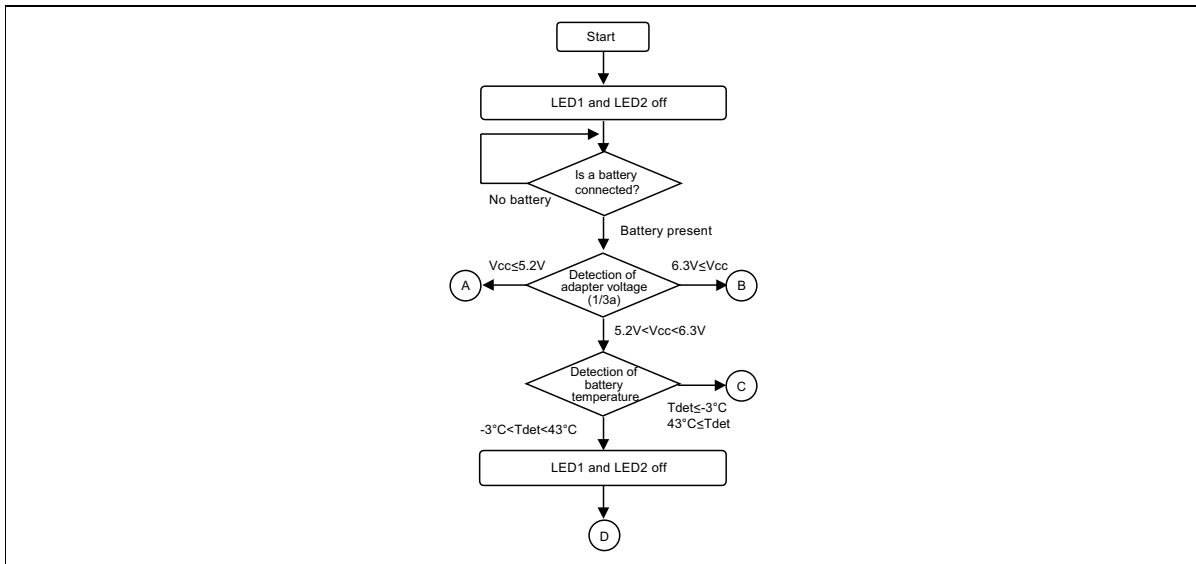

Item for detection	Time detection takes	Conditions for detection
Battery connection	10 ms × 1 time = 10 ms	Constantly detected every 400 ms (when more than a specified amount of charge-current is flowing, this detection is omitted).
Battery temperature	4 consecutive 50-ms periods = 200 ms	Presence of a battery
1.0-V	3 consecutive 25-ms periods = 75 ms	Presence of a battery and detection of normal temperature
2.0-V	3 consecutive 200-ms periods = 600 ms	Presence of a battery and detection of normal temperature
2.9-V	3 consecutive 200-ms periods = 600 ms	Presence of a battery and detection of normal temperature
3.9-	4 consecutive 1.6-s periods = 6.4 s	Completion of charging for a connected battery
Excessive voltage	3 consecutive 400-ms periods = 1.2 s	Presence of a battery
Charge completion	3 consecutive 3.2-s periods = 9.6 s	Presence of a battery and detection of normal temperature
Excessive charge current	3 consecutive 400-ms periods = 1.2 s	Charging is in progress
Adapter voltage 1	4 consecutive 50-ms periods = 200 ms	Constant detection (whenever charging has stopped)
Adapter voltage 2	4 consecutive 50-ms periods = 200 ms	Constant detection (during charging)
Adapter voltage 3a/3b	4 consecutive 200-ms periods = 0.8 s	Constant detection

Notes: 1. The timer for precharge 1 and 2 and the charge timer continue to count in the adapter-voltage standby modes and battery-temperature standby modes. Counting by these timers restarts from the previous value when charging resumes.

2. Detection of adapter-voltage abnormality (5.2/4.95/6.3 V) and battery connection is constant.

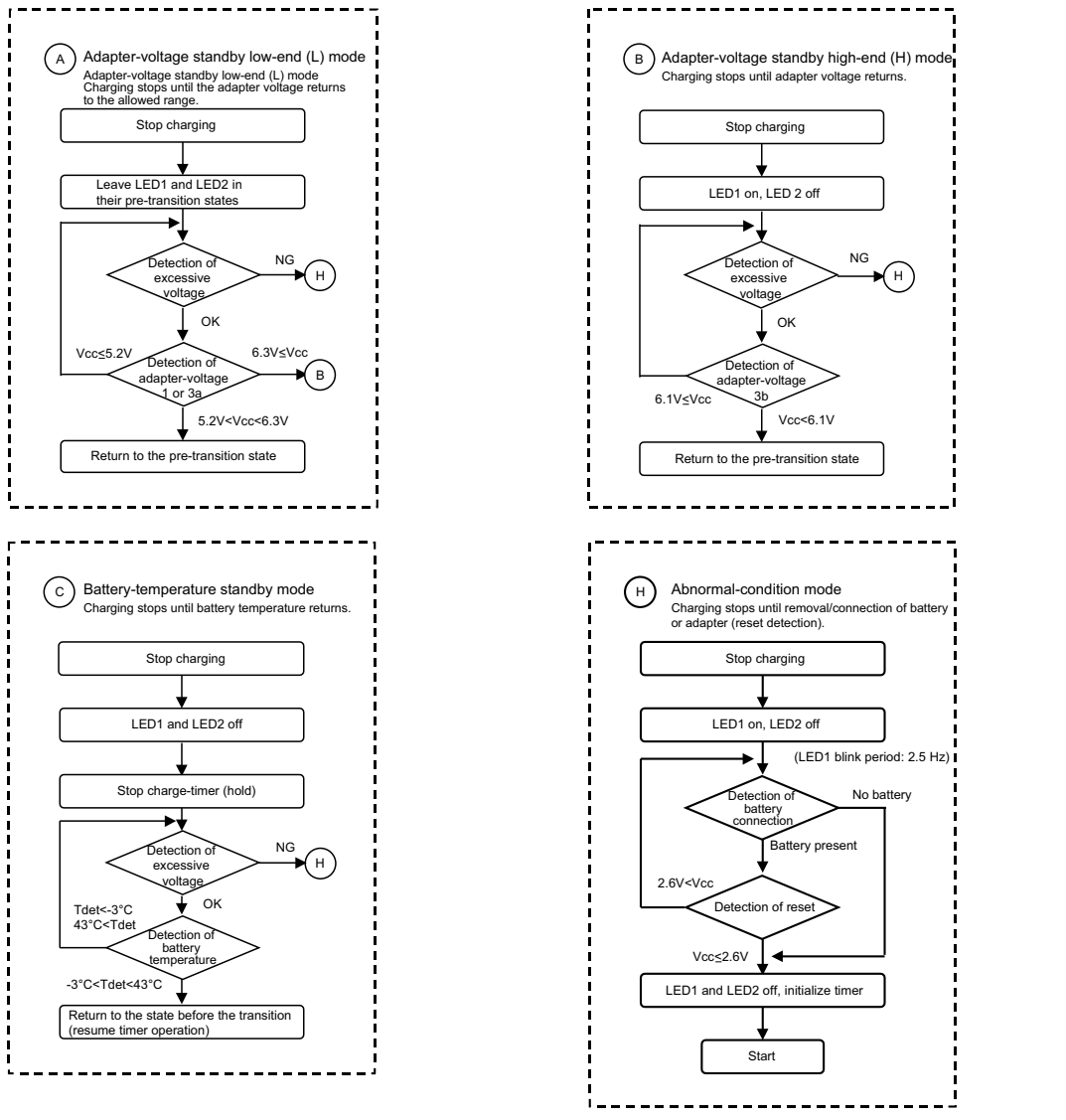

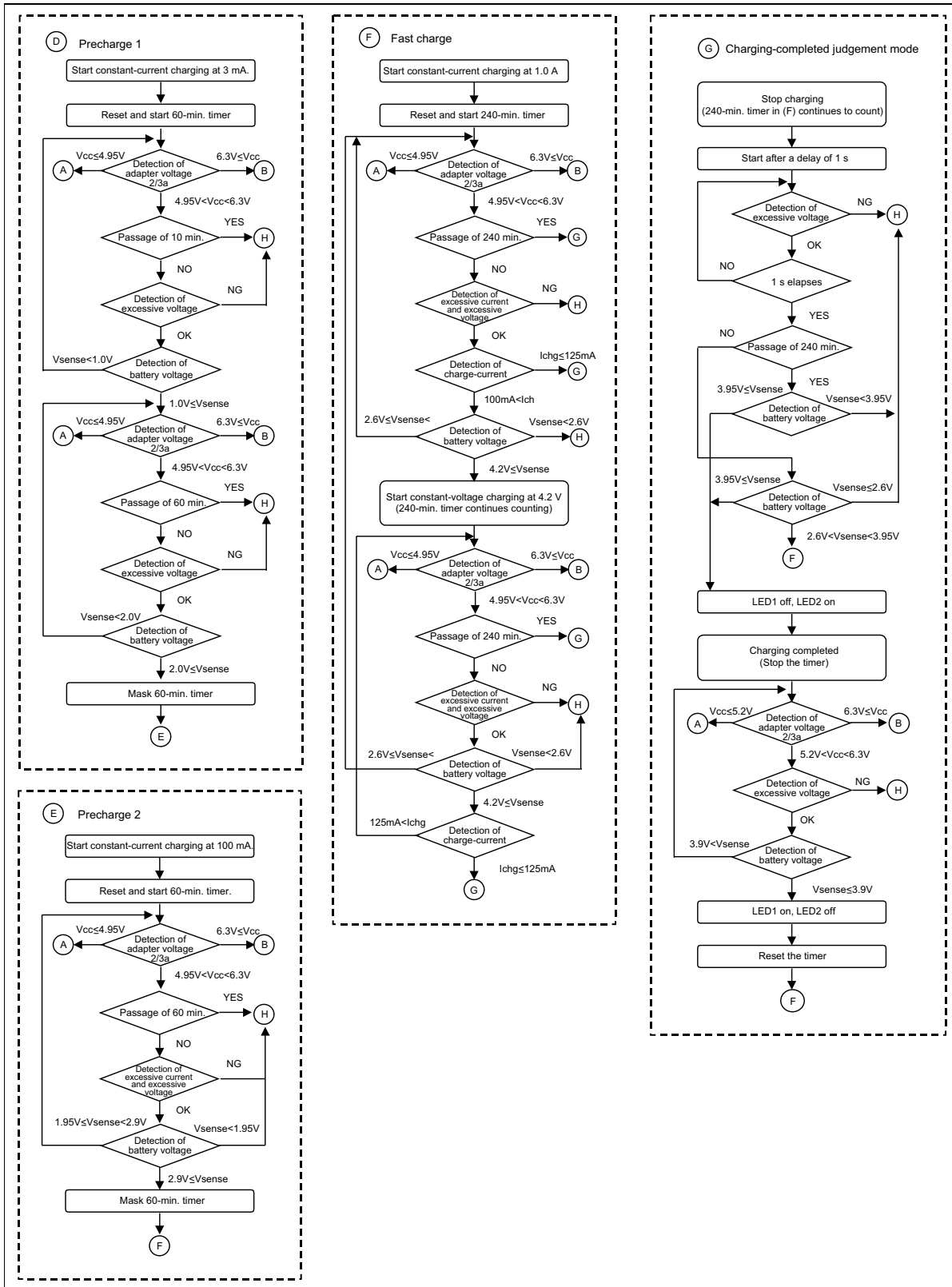

Timing chart

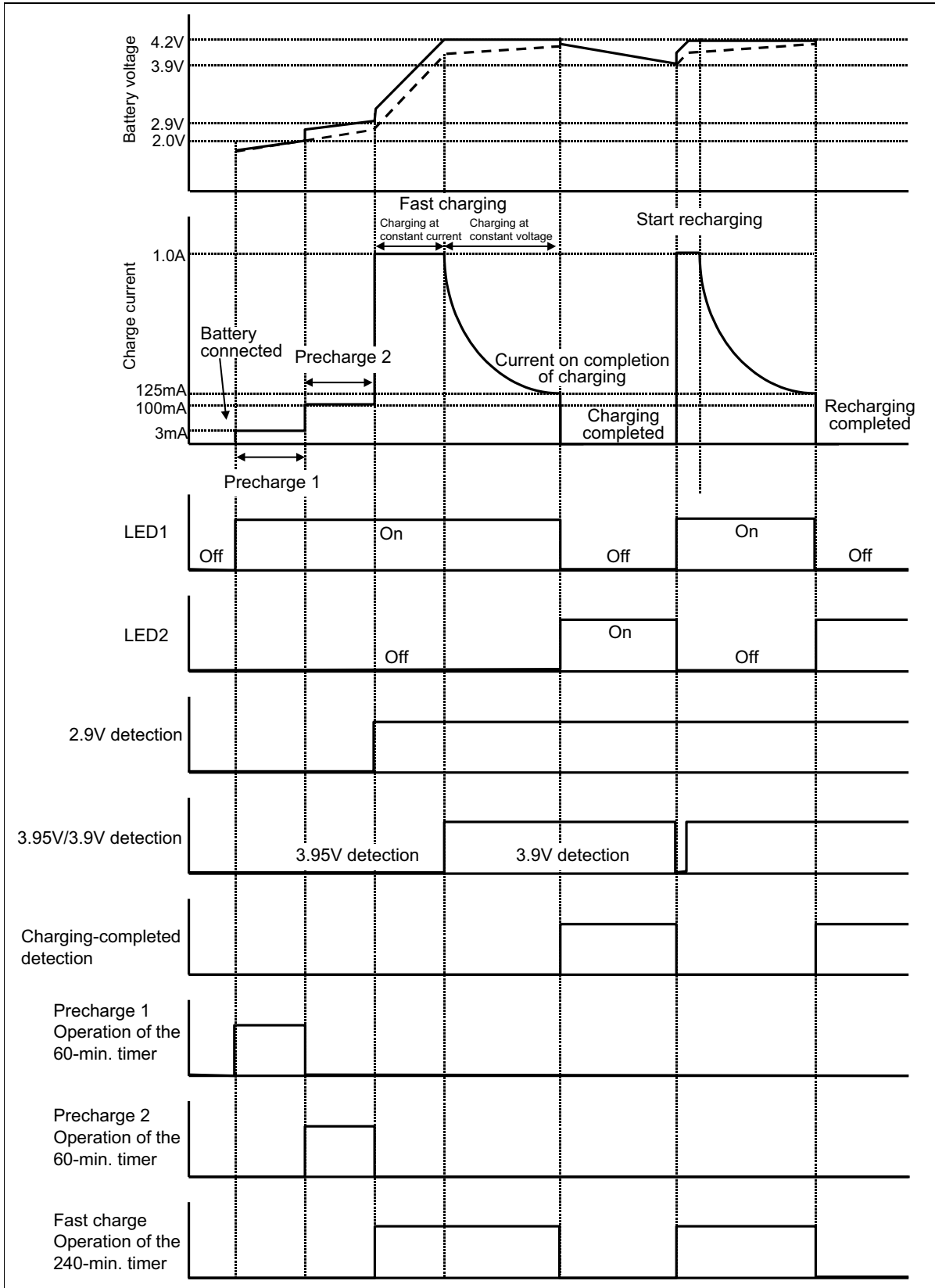

Description of operation

The detection times given in this section are for $T_{chg} = 240$ minutes.

The voltage values are all typical values.

The charge-current values are for $R_S = 0.2 \Omega$.

1. Detecting the adapter-voltage

When an adapter is connected, the voltage from the adapter is the V_{cc} -pin voltage for the power supply of the IC. Detection of the adapter voltage thus takes the form of monitoring of the V_{cc} -pin voltage; when this voltage departs from the specified range, charging stops, and the standby state (adapter-voltage standby mode) is entered. Detection is used to set up the following conditions.

When the adapter voltage falls:

- (1) When charging has stopped (adapter-detection voltage 1)
 - (a) If $V_{cc} > 5.2$ V, the IC enters the charging-enabled state.
 - (b) When $V_{cc} \leq 5.2$ V, the IC enters the corresponding charge-standby state (adapter-voltage standby, L mode).
- (2) During charging (adapter-detection voltage 2)
 - (a) As long as $V_{cc} > 4.95$ V, charging is continued.
 - (b) When $V_{cc} \leq 4.95$ V, the IC enters the corresponding charge-standby state (adapter-voltage standby, L mode).

When the adapter voltage rises:

- (1) When $V_{cc} \geq 6.3$ V, the IC enters the corresponding charge-standby state (adapter-voltage standby, H mode).
- (2) When $V_{cc} \leq 6.1$ V, the IC returns to the normal state.

Charging stops in adapter-voltage standby L mode, and the LEDs retain the states they had before the mode transition.

Charging stops in adapter-voltage standby H mode, but in this case LED1 blinks, and LED2 is turned off.

On normal resumption from either of the above modes, the system returns to the state before the mode transition.

Triggering of resets:

- (1) When $V_{cc} \leq 2.6$ V, operation of the IC is terminated (outside the operating range).
- (2) When $V_{cc} \geq 2.8$ V, the IC starts operation from the reset state.

2. Detecting a connected battery

The IC uses the conditions below to test for battery connection. The conditions are designed for use with batteries in battery packs that do not include thermistor pins.

- (1) Either of the following conditions is assumed to indicate that a battery is connected.
 - (a) Detection of a battery voltage of 1.0 V or more
 - (b) During application of precharge 1 for 400 ms, the battery-voltage never rises above 4 V.
- (2) Either of the following conditions is assumed to indicate the absence of a battery.
 - (a) During charging
 - Charging current remains at or below 100 mA (when the I_{full} pin is open), and the battery voltage remains at or below 1.0 V when the charge-switch is turned off every 400 ms.
 - (b) When charging has stopped
 - Battery-voltage is 1.0 V or less, and the battery voltage becomes 4 V or more after the 10-ms charge-switch is turned on.

3. Detecting battery temperature

The voltage produced by division by the externally connected pull-up resistor (for V_{cvref}) and external thermistor is input to the Tdet pin. This voltage indicates the battery's temperature. How the temperature limits affect operation is described below.

(1) When charging is to start

Charging starts as long as the temperature is within the range from -3.5°C to 43°C .

(2) While charging

Charging stops and the IC enters the corresponding standby mode (battery-temperature standby mode) if the temperature departs from the -5°C to 55°C range.

4. Precharge 1 (3-mA constant-current charge)

Precharge 1 starts when a connected battery is detected and one of the conditions below are satisfied. The 3-mA current value for precharge 1 is an internal setting.

(1) $V_{cc} \geq 5.2\text{ V}$

(2) Battery temperature is greater than or equal to -3°C and less than 43°C

Transitions from pre-charge 1 to other modes occur under the following conditions.

(1) When the battery voltage is 2.0 V or more, the 60-min. timer is masked and the IC makes the transition to precharge 2.

(2) The IC enters the abnormal mode when the battery voltage is 1.0 V or less 10 minutes after the start of a period in precharge 1.

(3) The IC enters the abnormal mode when the battery-voltage is 2.0 V or less 60 minutes after the start of a period in precharge 2.

5. Precharge 2 (100-mA constant-current charge)

When the battery-voltage is 2.0 V or more but less than 2.9 V during precharge-1 operation, the IC enters precharge 2. The current value of precharge 2 is controlled so that the voltage between pins Idet1 and Idet2 is 20 mV, which is an internal setting. When $R_S = 0.2\ \Omega$, constant-current control obtains $20\text{ mV}/0.2\ \Omega = 100\text{ mA}$.

Transitions from precharge 2 to other modes occur under one of the following conditions.

(1) When the battery voltage is 2.9 V or more, the 60-min. timer is masked and the IC makes the transition to fast-charge mode.

(2) The IC enters the abnormal mode when the battery-voltage is 2.9 V or less 60 minutes after the start of a period in precharge2.

(3) The IC enters the abnormal mode when the battery voltage is below 1.95 V.

6. Fast charge (1.0-A constant-current charge/4.2-V constant voltage charge)

When the IC is in either precharge mode and the battery-voltage is 2.9 V or more, the IC starts fast charging, during which the battery is charged at constant current and then constant voltage.

Constant-current control is applied while the battery-voltage is 2.9 V or more but less than 4.2 V. During constant-current charging, the voltage between pins Idet1 and Idet2 is 200 mV. This is an internal setting. Accordingly, when $R_S = 0.2\ \Omega$, the constant-current value is $200\text{ mV}/0.2\ \Omega = 1.0\text{ A}$.

Constant-voltage control is applied while the battery voltage is 4.2 V. In charging at constant voltage, the charge current is controlled to keep the battery voltage at 4.2 V.

The following conditions govern transitions from fast charging to other modes.

(1) When the charging current is less than the charging-completed current, the IC makes the transition to the charging-completed judgement mode. An internally set voltage of 25 mV is the default measure for charging-completed current, so when $R_S = 0.2\ \Omega$, the current threshold is $25\text{ mV}/0.2\ \Omega = 125\text{ mA}$. When the Ifull pin is open-circuit, the above default value is selected; ground connection of Ifull selects a value of 15 mV.

(2) When the charge-current does not fall below the charging-completed current within 240 minutes of the start of fast charging, the IC makes the transition to the charging-completed judgement mode. Note, however, that the judgement being made in the completion-judgement mode differs from that for the transition of item (1).

(3) The IC enters the abnormal mode when the battery voltage is 2.6 V or less.

7. Charging-completed judgement

- (1) When fast charging is in progress and the charging current falls below the charging-completed current, charging stops. One second later, the battery voltage is detected, and the IC performs one of the following operations according to the detected value.
 - (a) If the voltage is 3.95 V or more, LED1 is turned off and LED2 is turned on. This indicates the completion of charging.
 - (b) If the battery-voltage is 2.6 V or more but below 3.95 V, the IC makes the transition to fast charging.
 - (c) If the battery-voltage is below 2.6 V, the IC enters the abnormal mode.
- (2) When the charging current is not below the charging-completed current 240 minutes after the start of fast charging, charging stops. One second later, the battery voltage is detected, and the IC performs one of the following operations according to the detected voltage value.
 - (a) If the battery-voltage is 3.95 V or more, LED1 is turned off and LED2 is turned. This indicates the completion of charging.
 - (b) If the battery-voltage is below 3.95 V, the IC enters the abnormal mode.

8. Recharging

On completion of charging, the IC continues to detect the battery voltage. When the voltage is 3.9 V or less, the timer is initialized and recharging in the form of fast charging starts up.

9. Detecting abnormality

When a condition in the list below is detected, the IC judges that the current state is abnormal and stops charging (abnormal mode). Other than as described in item (8) below, the battery or adapter is disconnected and then connected to make operation resume from the abnormal mode .

- (1) The battery voltage is 1.0 V or less after 10 minutes in precharge 1.
- (2) The battery voltage is 2.0 V or less after 60 minutes in precharge 1.
- (3) Charging in the precharge-2 mode has continued for 60 minutes.
- (4) The battery voltage is 2.6 V or less during fast charging.
- (5) The battery voltage is 2.6 V or less at charging-completed judgement.
- (6) The battery voltage is 4.35 V or more and excessive voltage is detected.
- (7) The charging current is 1.5 A or more and excessive current is detected.
- (8) The adapter voltage (voltage on the Vcc pin) is 6.3 V or more and excessive adapter-voltage is detected. Note, however, that when 6.1 V or less is detected, the IC returns to a normal state (adapter-voltage standby H mode).
- (9) The battery-voltage is below 1.95 V in the precharge-2 mode.
- (10) The battery-voltage is below 3.95 V 240 minutes after the start of fast charging.

10. LED display

State	LED1 (red)	LED2 (green)
Battery disconnected	Off	Off
Charging in progress	On	Off
Charging completed	Off	On
Temperature-standby mode	Off	Off
Adapter-voltage standby L mode	Retains the previous state	Retains the previous state
Adapter-voltage standby H mode	Blinking	Off
Abnormal mode	Blinking	Off

When LED2 (green) is not in use, fixing the LED2 pin to low level selects a blinking period of 0.625 Hz (typ.) for LED1 (red).

Note: When LED2 (green) is not in use, the LED2 pin must either be pulled up by a resistor or connected to ground.

11. Setting the voltages

The recharge-start voltage, adapter-detection voltage 1, and adapter-detection voltage 2 can be adjusted to desired thresholds through the connection of external resistors that adjust the voltages on the Vrchg, Vadv1, and Vadv2 pins, respectively.

When a pin is open, the corresponding voltage is the IC's internal setting as specified in the electrical characteristics.

When the Vadv1 pin, Vadv2 pin, and Vrchg pin are open-circuit, the output voltage is the VBG voltage (constant voltage source used inside the IC) divided by 20 kΩ and 100 kΩ, as shown in section 2, Pin-Internal Equivalent Circuits. The settings are given below.

<Method of setting>

Let the detection voltages when the recharge-start voltage, adapter-detection voltage 1, and adapter-detection voltage 2 pins are open-circuit be Vrchg_o (V), Vadv1_o (V), and Vadv2_o (V), respectively, and the required detection-voltage values be Vrchg_c (V), Vadv1_c (V), and Vadv2_c (V), respectively. The voltage to be applied to each of the adjustment pins is then obtained by the equations under (1), (2), and (3) below.

(1) Recharge-start voltage

$$\text{Voltage setting on the Vrchg pin (V)} = \frac{\text{Voltage on the Vrchg pin (open-circuit)}}{\text{Vrchg}_o} \times \text{Vrchg}_c$$

(2) Adapter-detection voltage 1

$$\text{Voltage setting on the Vadv1 pin (V)} = \frac{\text{Voltage on the Vadv1 pin (open-circuit)}}{\text{Vadv1}_o} \times \text{Vadv1}_c$$

(3) Adapter-detection voltage 2

$$\text{Voltage setting on the Vadv2 pin (V)} = \frac{\text{Voltage on the Vadv2 pin (open-circuit)}}{\text{Vadv2}_o} \times \text{Vadv2}_c$$

Desired detection values are obtained by using external resistors to apply the voltages obtained by the above equations to the corresponding pins.

Either connect a resistor between the adjustment pin and ground, or connect one resistor between the Vcvref pin and adjustment pin and another between the adjustment pin and ground. Note, however, when using the Vcvref pin, that -5 mA is specified as the maximum load-current for this pin. Take care in selecting the resistor values.

Note: In the descriptions of pins Vrchg, Vadv1, and Vadv2 pins in section 1, Description of pins, decibel units are used to describe how the voltages on these pins set the detection voltages. The values used in the above equations are calculated after changing the values as shown below. The calculation is on the assumption that each pin carries the rated voltage of 1.0 V when in its open-circuit state.

(4) Recharge-start voltage

$$\frac{\text{Vrchg}_c}{\text{Voltage on the Vrchg pin}} = \frac{\text{Vrchg}_o}{\text{Voltage on the Vrchg pin (open-circuit)}} \quad 3.95 \rightarrow 11.8\text{dB}$$

(5) Adapter-detection voltage 1

$$\frac{V_{rchg_c}}{\text{Voltage on the Vadp1 pin}} = \frac{V_{rchg_o}}{\text{Voltage on the Vadp1 pin (open-circuit)}} \quad 5.20 \rightarrow 14.3\text{dB}$$

(6) Adapter-detection voltage 2

$$\frac{V_{rchg_c}}{\text{Voltage on the Vadp2 pin}} = \frac{V_{rchg_o}}{\text{Voltage on the Vadp2 pin (open-circuit)}} \quad 4.95 \rightarrow 13.9\text{dB}$$

12. Forcible termination of charging

Charge is forcibly stopped by setting the STOP signal to low level. At this time, the LEDs are turned off and all timers are initialized.

13. Frequency of oscillation

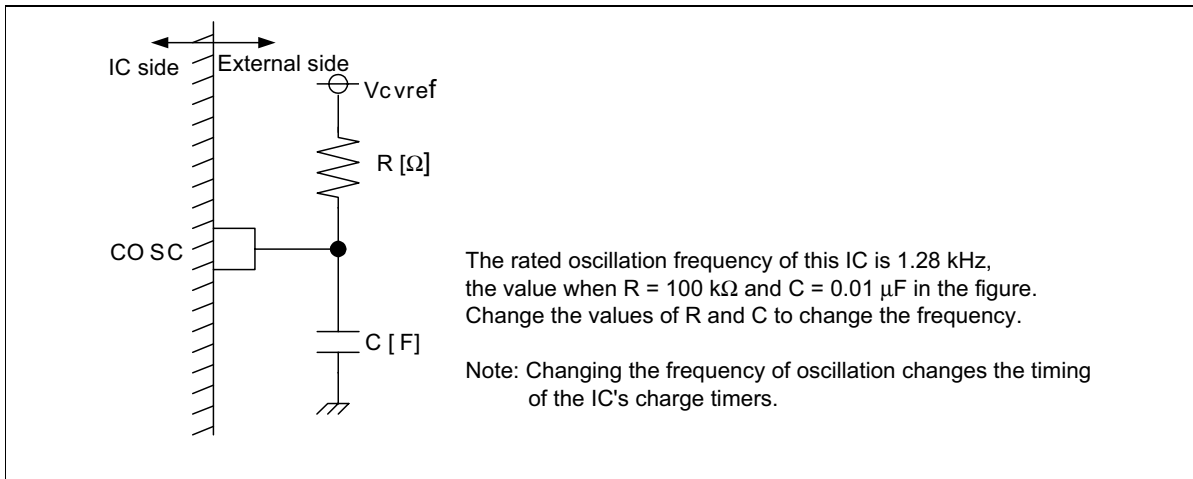

(1) External C, R, and oscillation frequency

		C [μF]					
		0.0022	0.047	0.01	0.022	0.047	0.1
R [Ω]	82k	5.695	2.666	1.253	0.570	0.267	0.125
	91k	5.878	2.751	1.298	0.588	0.275	0.129
	100k	5.818	2.723	1.280	0.582	0.272	0.128
	110k	5.647	2.643	1.242	0.565	0.264	0.124
	120k	5.435	2.544	1.196	0.543	0.254	0.120
	130k	5.210	2.439	1.146	0.521	0.244	0.115

Note: Frequency is in kHz. Variation of C and R values is not taken into account.

(2) Relation between the frequency of oscillation and timing, for each timer

Item	Value (frequency of oscillation = Fosc (Hz))
Charge timer (min.)	1.28k/Fosc × 240
Precharge timer 1 (min.)	1.28k/Fosc × 10
Precharge timer 2 (min.)	1.28k/Fosc × 60
Frequency of LED1 blinking (LED2 = high) (Hz)	Fosc/1.28k × 2.5
Frequency of LED1 blinking (LED2 = ground) (Hz)	Fosc/1.28k × 0.625

Sample application circuit

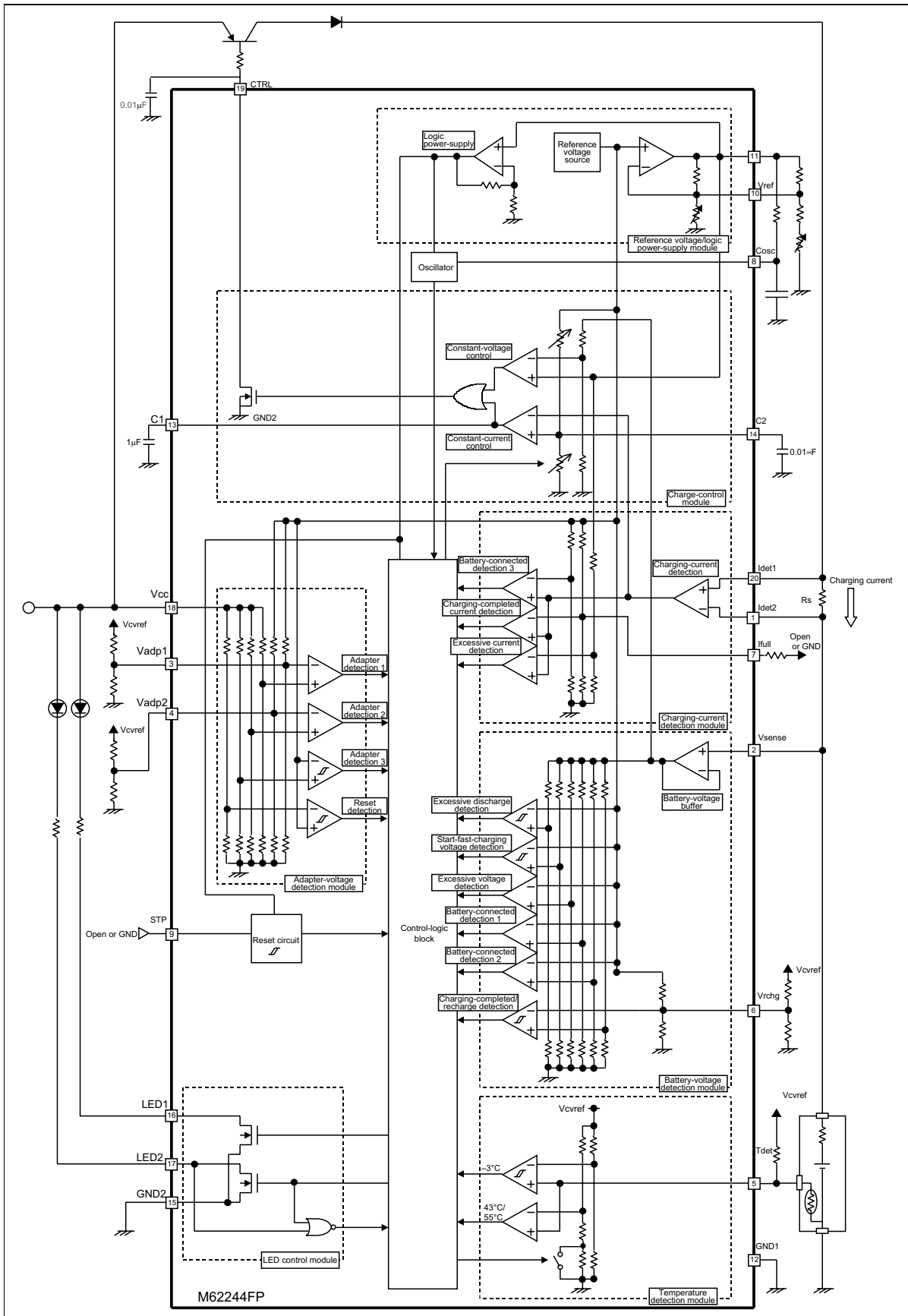

Package Dimensions

20T2X

Note : Please contact Renesas Technology Corporation for further details.

RENESAS Technology Corp. Sales Strategic Planning Div. Nippon Bldg., 2-6-2, Ohte-machi, Chiyoda-ku, Tokyo 100-0004, Japan

Keep safety first in your circuit designs!

1. Renesas Technology Corp. puts the maximum effort into making semiconductor products better and more reliable, but there is always the possibility that trouble may occur with them. Trouble with semiconductors may lead to personal injury, fire or property damage.
Remember to give due consideration to safety when making your circuit designs, with appropriate measures such as (i) placement of substitutive, auxiliary circuits, (ii) use of nonflammable material or (iii) prevention against any malfunction or mishap.

Notes regarding these materials

1. These materials are intended as a reference to assist our customers in the selection of the Renesas Technology Corp. product best suited to the customer's application; they do not convey any license under any intellectual property rights, or any other rights, belonging to Renesas Technology Corp. or a third party.
 2. Renesas Technology Corp. assumes no responsibility for any damage, or infringement of any third-party's rights, originating in the use of any product data, diagrams, charts, programs, algorithms, or circuit application examples contained in these materials.
 3. All information contained in these materials, including product data, diagrams, charts, programs and algorithms represents information on products at the time of publication of these materials, and are subject to change by Renesas Technology Corp. without notice due to product improvements or other reasons. It is therefore recommended that customers contact Renesas Technology Corp. or an authorized Renesas Technology Corp. product distributor for the latest product information before purchasing a product listed herein.
The information described here may contain technical inaccuracies or typographical errors.
Renesas Technology Corp. assumes no responsibility for any damage, liability, or other loss rising from these inaccuracies or errors.
Please also pay attention to information published by Renesas Technology Corp. by various means, including the Renesas Technology Corp. Semiconductor home page (<http://www.renesas.com>).
 4. When using any or all of the information contained in these materials, including product data, diagrams, charts, programs, and algorithms, please be sure to evaluate all information as a total system before making a final decision on the applicability of the information and products. Renesas Technology Corp. assumes no responsibility for any damage, liability or other loss resulting from the information contained herein.
 5. Renesas Technology Corp. semiconductors are not designed or manufactured for use in a device or system that is used under circumstances in which human life is potentially at stake. Please contact Renesas Technology Corp. or an authorized Renesas Technology Corp. product distributor when considering the use of a product contained herein for any specific purposes, such as apparatus or systems for transportation, vehicular, medical, aerospace, nuclear, or undersea repeater use.
 6. The prior written approval of Renesas Technology Corp. is necessary to reprint or reproduce in whole or in part these materials.
 7. If these products or technologies are subject to the Japanese export control restrictions, they must be exported under a license from the Japanese government and cannot be imported into a country other than the approved destination.
Any diversion or reexport contrary to the export control laws and regulations of Japan and/or the country of destination is prohibited.
 8. Please contact Renesas Technology Corp. for further details on these materials or the products contained therein.
-



RENESAS SALES OFFICES

<http://www.renesas.com>

Renesas Technology America, Inc.
450 Holger Way, San Jose, CA 95134-1368, U.S.A
Tel: <1> (408) 382-7500 Fax: <1> (408) 382-7501

Renesas Technology Europe Limited.
Dukes Meadow, Millboard Road, Bourne End, Buckinghamshire, SL8 5FH, United Kingdom
Tel: <44> (1628) 585 100, Fax: <44> (1628) 585 900

Renesas Technology Europe GmbH
Dornacher Str. 3, D-85622 Feldkirchen, Germany
Tel: <49> (89) 380 70 0, Fax: <49> (89) 929 30 11

Renesas Technology Hong Kong Ltd.
7/F., North Tower, World Finance Centre, Harbour City, Canton Road, Hong Kong
Tel: <852> 2265-6688, Fax: <852> 2375-6836

Renesas Technology Taiwan Co., Ltd.
FL 10, #99, Fu-Hsing N. Rd., Taipei, Taiwan
Tel: <886> (2) 2715-2888, Fax: <886> (2) 2713-2999

Renesas Technology (Shanghai) Co., Ltd.
26/F., Ruijin Building, No.205 Maoming Road (S), Shanghai 200020, China
Tel: <86> (21) 6472-1001, Fax: <86> (21) 6415-2952

Renesas Technology Singapore Pte. Ltd.
1, Harbour Front Avenue, #06-10, Keppel Bay Tower, Singapore 098632
Tel: <65> 6213-0200, Fax: <65> 6278-8001