



# 2SB1455/2SD2203

## 80V/7A High-Current Switching Applications

### Features

- Low collector-to-emitter saturation voltage.
- Large current capacity.
- Micaless package facilitating easy mounting.

### Package Dimensions

unit:mm  
2041A

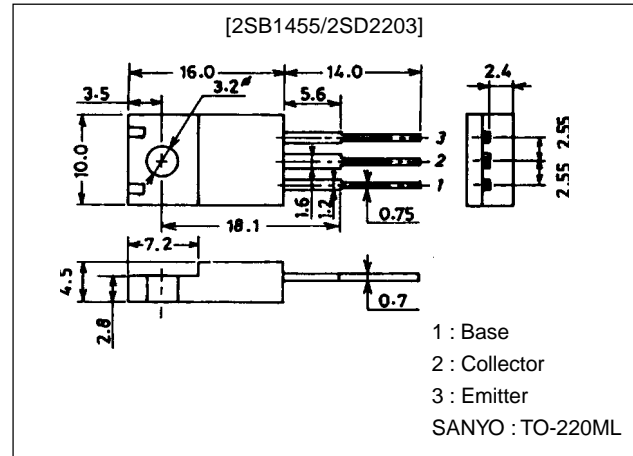

( ) : 2SB1455

### Specifications

#### Absolute Maximum Ratings at Ta = 25°C

Parameter	Symbol	Conditions	Ratings	Unit
Collector-to-Base Voltage	$V_{CB0}$		(-)90	V
Collector-to-Emitter Voltage	$V_{CE0}$		(-)80	V
Emitter-to-Base Voltage	$V_{EB0}$		(-)6	V
Collector Current	$I_C$		(-)7	A
Collector Current (Pulse)	$I_{CP}$		(-)12	A
Collector Dissipation	$P_C$		2.0	W
		$T_c=25^\circ\text{C}$	30	W
Junction Temperature	$T_J$		150	°C
Storage Temperature	$T_{stg}$		-55 to +150	°C

#### Electrical Characteristics at Ta = 25°C

Parameter	Symbol	Conditions	Ratings			Unit
			min	typ	max	
Collector Cutoff Current	$I_{CBO}$	$V_{CB}=-80\text{V}, I_E=0$			(-)0.1	mA
Emitter Cutoff Current	$I_{EBO}$	$V_{EB}=-4\text{V}, I_C=0$			(-)0.1	mA
DC Current Gain	$h_{FE1}$	$V_{CE}=-2\text{V}, I_C=-1\text{A}$	70*		280*	
	$h_{FE2}$	$V_{CE}=-2\text{V}, I_C=-4\text{A}$	30			
Gain-Bandwidth Product	$f_T$	$V_{CE}=-5\text{V}, I_C=-1\text{A}$		20		MHz
Collector-to-Emitter Saturation Voltage	$V_{CE(sat)}$	$I_C=-4\text{A}, I_B=-0.4\text{A}$			0.4	V
					(-)0.5	V

\* : The 2SB1455/2SD2203 are classified by 1A  $h_{FE}$  as follows :

70	Q	140	100	R	200	140	S	280
----	---	-----	-----	---	-----	-----	---	-----

■ Any and all SANYO products described or contained herein do not have specifications that can handle applications that require extremely high levels of reliability, such as life-support systems, aircraft's control systems, or other applications whose failure can be reasonably expected to result in serious physical and/or material damage. Consult with your SANYO representative nearest you before using any SANYO products described or contained herein in such applications.

■ SANYO assumes no responsibility for equipment failures that result from using products at values that exceed, even momentarily, rated values (such as maximum ratings, operating condition ranges, or other parameters) listed in products specifications of any and all SANYO products described or contained herein.

**SANYO Electric Co., Ltd. Semiconductor Business Headquarters**

TOKYO OFFICE Tokyo Bldg., 1-10, 1 Chome, Ueno, Taito-ku, TOKYO, 110-8534 JAPAN

N1098HA (KT)/5111MH (KOTO) No.3250-1/4

## 2SB1455/2SD2203

Parameter	Symbol	Conditions	Ratings			Unit
			min	typ	max	
Collector-to-Base Breakdown Voltage	$V_{(BR)CBO}$	$I_C = (-)1mA, I_E = 0$	(-)90			V
Collector-to-Emitter Breakdown Voltage	$V_{(BR)CEO}$	$I_C = (-)1mA, R_{BE} = \infty$	(-)80			V
Emitter-to-Base Breakdown Voltage	$V_{(BR)EBO}$	$I_E = (-)1mA, I_C = 0$	(-)6			V
Turn-ON Time	$t_{on}$	See specified test circuit.		(0.2)		$\mu s$
				0.1		$\mu s$
Storage Time	$t_{stg}$	See specified test circuit.		(0.7)		$\mu s$
				1.6		$\mu s$
Fall Time	$t_f$	See specified test circuit.		(0.2)		$\mu s$
				0.4		$\mu s$

### Switching Time Test Circuit

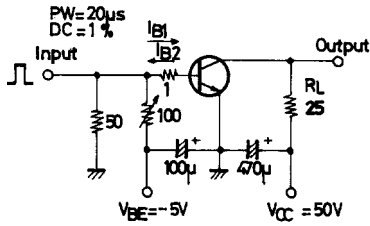

$$10 I_{B1} = -10 I_{B2} = I_C = 2A$$

For PNP, the polarity is reversed.

Unit (resistance :  $\Omega$ , capacitance : F)

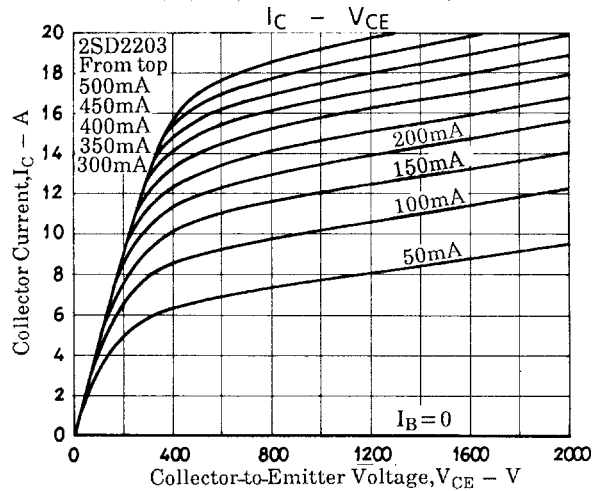
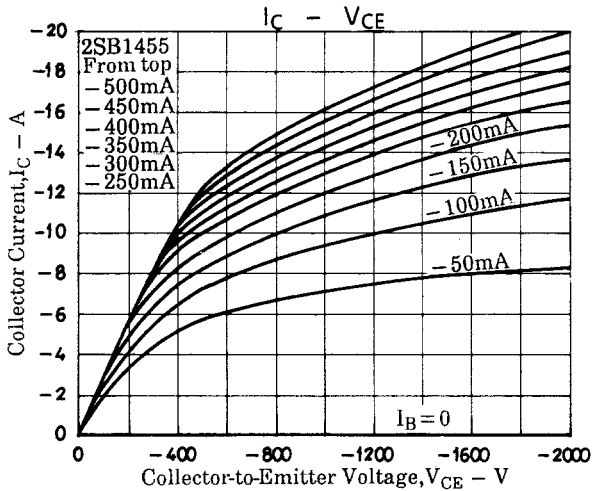
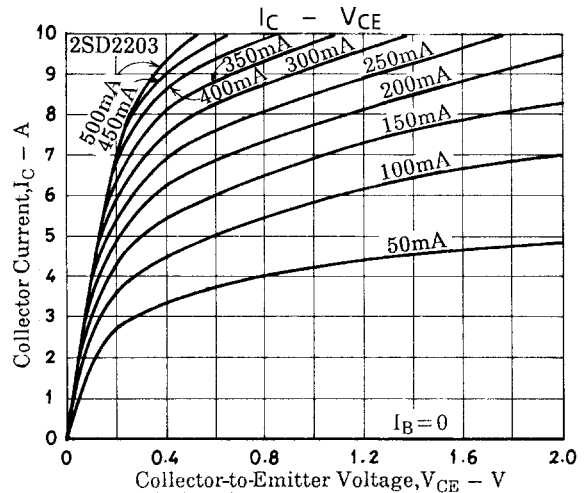
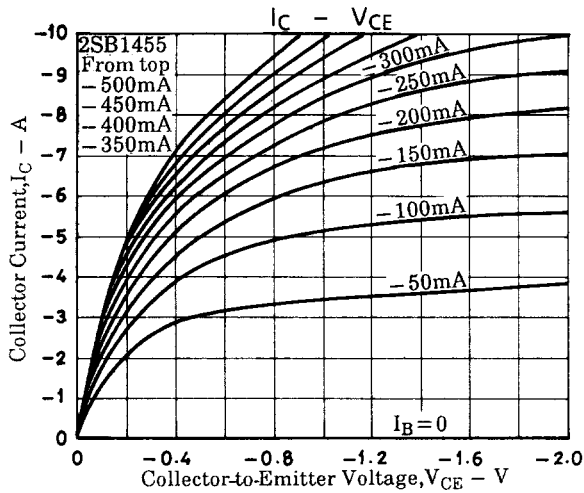

# 2SB1455/2SD2203

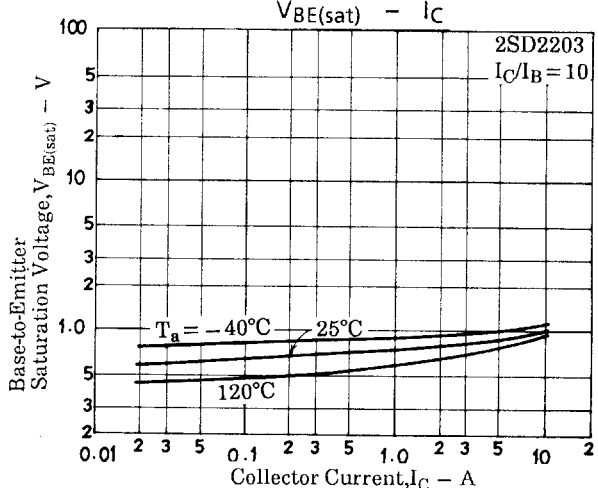
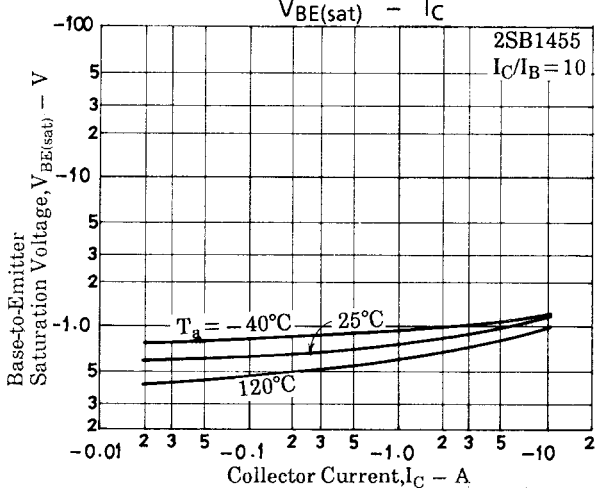
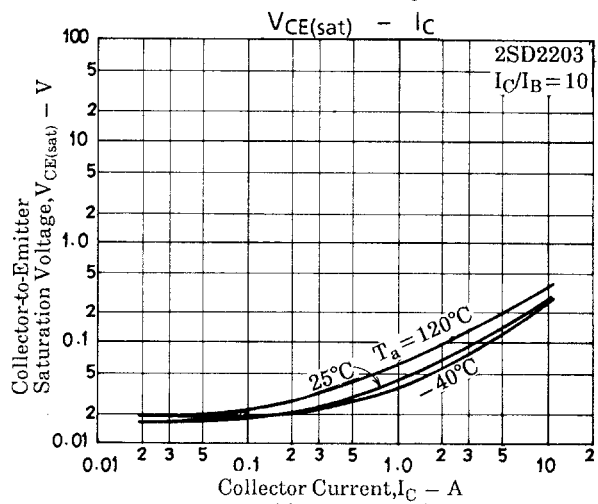
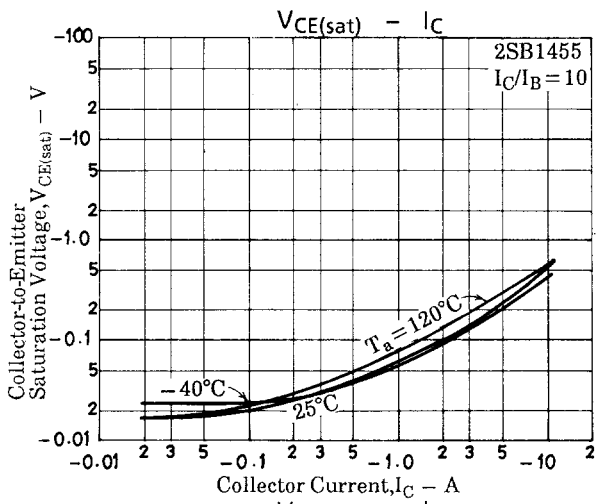
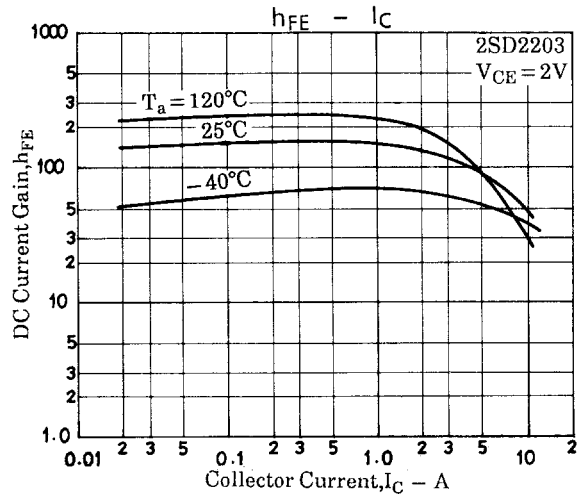
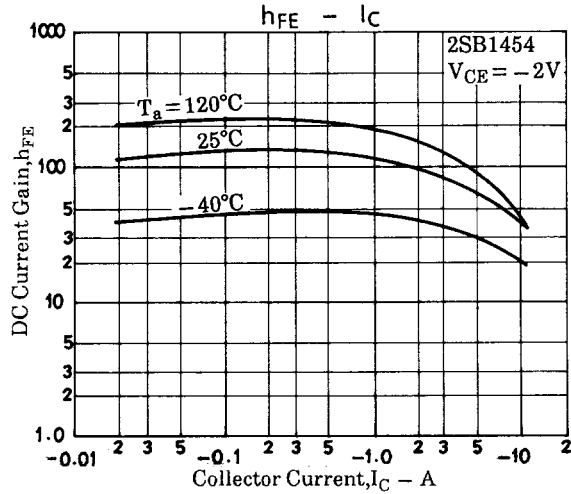
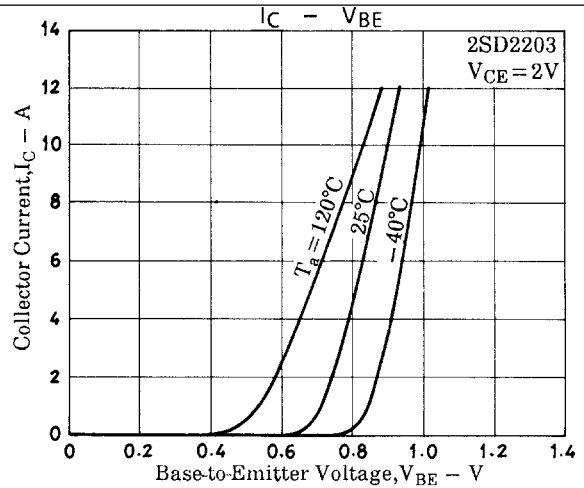
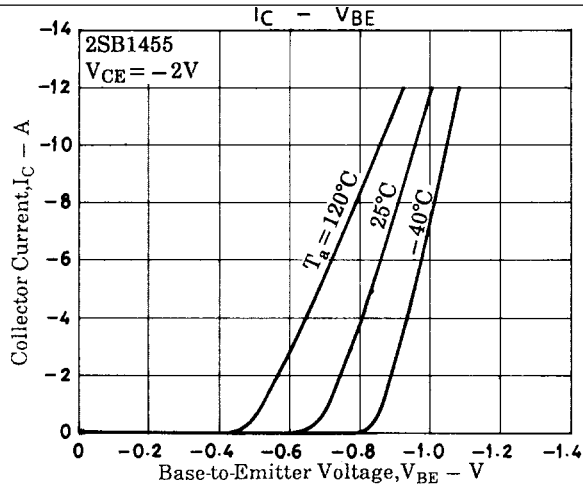

## 2SB1455/2SD2203

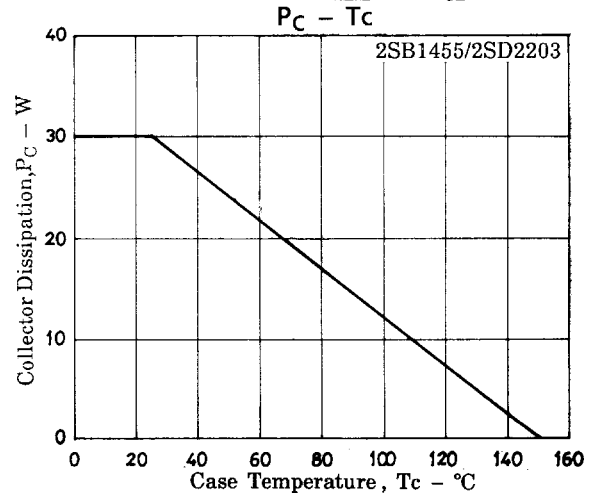
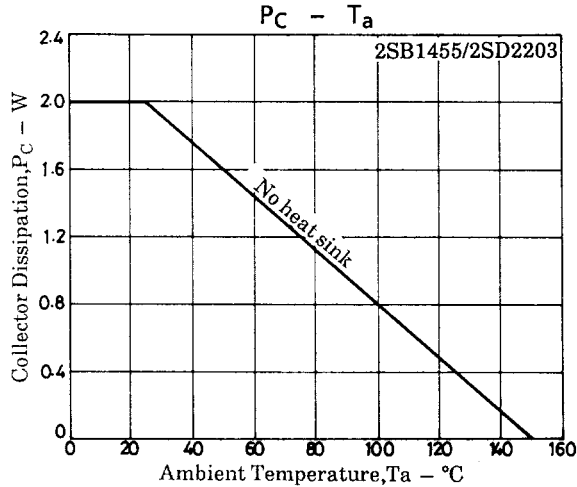
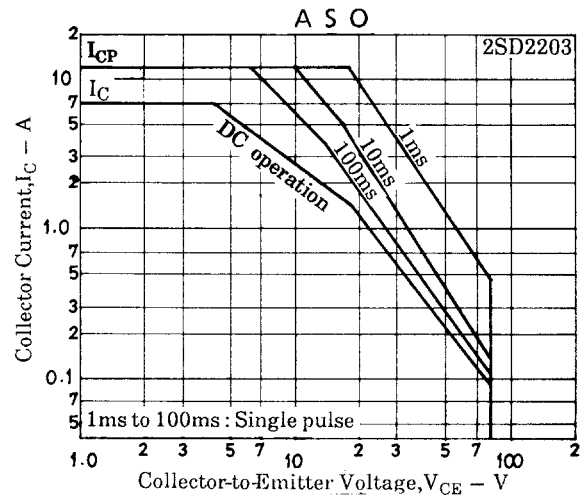
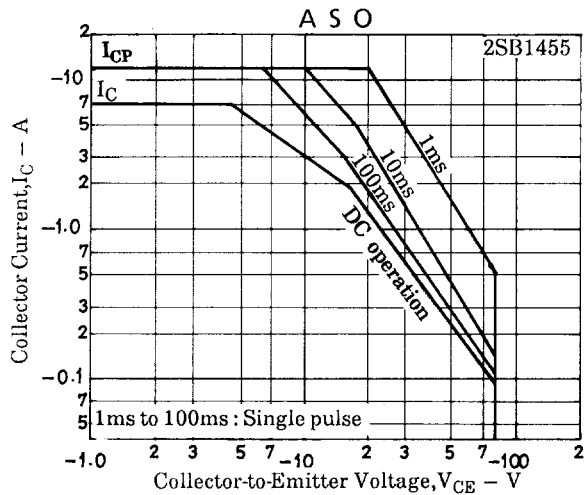

- Specifications of any and all SANYO products described or contained herein stipulate the performance, characteristics, and functions of the described products in the independent state, and are not guarantees of the performance, characteristics, and functions of the described products as mounted in the customer's products or equipment. To verify symptoms and states that cannot be evaluated in an independent device, the customer should always evaluate and test devices mounted in the customer's products or equipment.
- SANYO Electric Co., Ltd. strives to supply high-quality high-reliability products. However, any and all semiconductor products fail with some probability. It is possible that these probabilistic failures could give rise to accidents or events that could endanger human lives, that could give rise to smoke or fire, or that could cause damage to other property. When designing equipment, adopt safety measures so that these kinds of accidents or events cannot occur. Such measures include but are not limited to protective circuits and error prevention circuits for safe design, redundant design, and structural design.
- In the event that any or all SANYO products (including technical data, services) described or contained herein are controlled under any of applicable local export control laws and regulations, such products must not be exported without obtaining the export license from the authorities concerned in accordance with the above law.
- No part of this publication may be reproduced or transmitted in any form or by any means, electronic or mechanical, including photocopying and recording, or any information storage or retrieval system, or otherwise, without the prior written permission of SANYO Electric Co., Ltd.
- Any and all information described or contained herein are subject to change without notice due to product/technology improvement, etc. When designing equipment, refer to the "Delivery Specification" for the SANYO product that you intend to use.
- Information (including circuit diagrams and circuit parameters) herein is for example only; it is not guaranteed for volume production. SANYO believes information herein is accurate and reliable, but no guarantees are made or implied regarding its use or any infringements of intellectual property rights or other rights of third parties.

This catalog provides information as of November, 1998. Specifications and information herein are subject to change without notice.