

M54539P

6-UNIT 700mA TRANSISTOR ARRAY WITH CLAMP DIODE

DESCRIPTION

M54539P six-circuit transistor arrays. The circuits are made of NPN transistors. Both the semiconductor integrated circuits perform high-current driving with extremely low input-current supply.

FEATURES

- Medium breakdown voltage ($BV_{CEO} \geq 20V$)
- High-current driving ($I_{c(max)} = 700mA$)
- With output clamping diodes
- Wide operating temperature range ($T_a = -20$ to $+75^\circ C$)

APPLICATION

Drives of relays and printers, digit drives of indication elements (LEDs and lamps), and drives of thermal printer

FUNCTION

The M54539P have six circuits consisting of NPN transistors. Resistance of $2k\Omega$ is connected to the inputs. The output transistor emitters are connected to the GND pin (pin 8). A spick-killer clamping diode is provided between each collector and COM pin (pin 9), V_{cc} is connected to pin 16. The collector current is 700 mA maximum. Collector-emitter supply voltage is 20V maximum.

PIN CONFIGURATION (TOP VIEW)

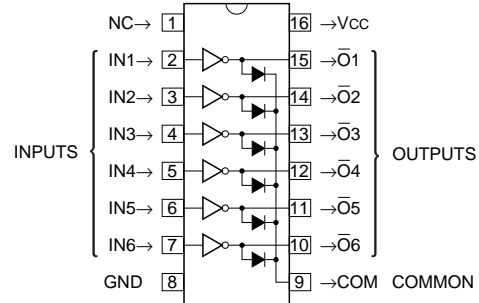

Outline 16P4(P)

NC : No connection

CIRCUIT SCHEMATIC

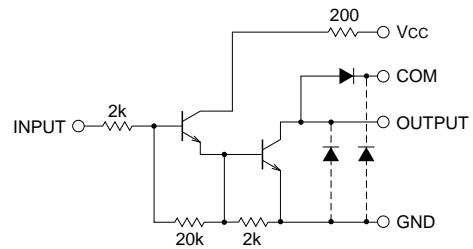

The six circuits share the V_{cc} , COM and GND.

The diodes shown by broken line are parasite diodes and must not be used.

Unit : Ω

ABSOLUTE MAXIMUM RATINGS (Unless otherwise noted, $T_a = -20 \sim +75^\circ C$)

Symbol	Parameter	Conditions	Ratings	Unit
V_{cc}	Supply voltage		10	V
V_{CEO}	Collector-emitter voltage	Output, H	$-0.5 \sim +20$	V
I_C	Collector current	Current per circuit output, L	700	mA
V_I	Input voltage		$-0.5 \sim +10$	V
V_R	Clamping diode reverse voltage		20	V
I_F	Clamping diode forward current	Pulse Width $\leq 35ms$, Duty Cycle $\leq 5\%$	700	mA
			350	
P_d	Power dissipation	$T_a = 25^\circ C$, when mounted on board	1.47	W
T_{opr}	Operating temperature		$-20 \sim +75$	$^\circ C$
T_{stg}	Storage temperature		$-55 \sim +125$	$^\circ C$

6-UNIT 700mA TRANSISTOR ARRAY WITH CLAMP DIODE

RECOMMENDED OPERATING CONDITIONS (Unless otherwise noted, Ta = -20 ~ +75°C)

Symbol	Parameter	Limits			Unit	
		min	typ	max		
Vcc	Supply voltage	3	5	7	V	
Vo	Output voltage	0	—	20	V	
Ic	Collector current per channel	Vcc = 6.5V, The three outputs conducting simultaneously Percent duty cycle less than 20%	0	—	700	mA
		Vcc = 6.5V, The three outputs conducting simultaneously Percent duty cycle less than 90%	0	—	200	
VIH	"H" input voltage	IC ≤ 450mA			V	
VIL	"L" input voltage	0	—	0.3	V	

ELECTRICAL CHARACTERISTICS (Unless otherwise noted, Ta = -20 ~ +75°C)

Symbol	Parameter	Test conditions	Limits			Unit
			min	typ*	max	
V (BR) CEO	Collector-emitter breakdown voltage	VCC = 7V, ICEO = 100µA	20	—	—	V
VCE (sat)	Collector-emitter saturation voltage	VI = 3V, VCC = 5V, IC = 450mA	—	0.46	0.8	V
		VI = 3V, VCC = 5V, IC = 200mA	—	0.2	0.45	
II	Input current	VCC = 7V, VI = 3.2V	—	0.75	1.4	mA
IR	Clamping diode reverse current	VR = 20V	—	—	100	µA
VF	Clamping diode forward voltage	IF = 350mA	—	1.5	2.7	V
ICC	Supply current	VCC = 7V, VI = 3.2V (Per operating one circuit)	—	27.5	50	mA
hFE	DC amplification factor	VCE = 4V, VCC = 6V, IC = 300mA, Ta = 25°C	3000	8000	—	—

* : The typical values are those measured under ambient temperature (Ta) of 25°C. There is no guarantee that these values are obtained under any conditions.

SWITCHING CHARACTERISTICS (Unless otherwise noted, Ta = 25°C)

Symbol	Parameter	Test conditions	Limits			Unit
			min	typ	max	
ton	Turn-on time	CL = 15pF (note 1)	—	16	—	ns
toff	Turn-off time		—	1000	—	ns

NOTE 1 TEST CIRCUIT

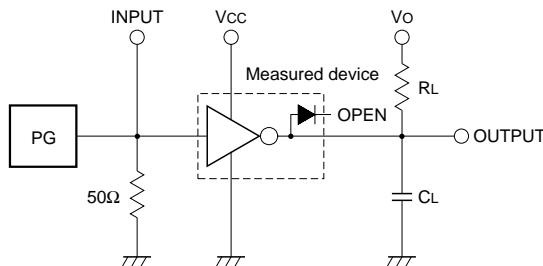

- (1) Pulse generator (PG) characteristics : PRR = 1kHz, tw = 10µs, tr = 6ns, tf = 6ns, ZO = 50Ω, VP = 3VP-P
- (2) Input-output conditions : RL = 22.5Ω, Vo = 10V, Vcc = 5V
- (3) Electrostatic capacity CL includes floating capacitance at connections and input capacitance at probes

TIMING DIAGRAM

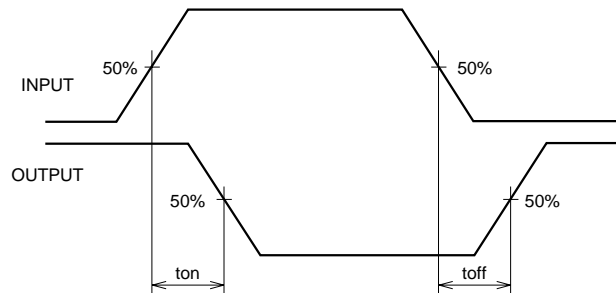

TYPICAL CHARACTERISTICS

Thermal Derating Factor Characteristics

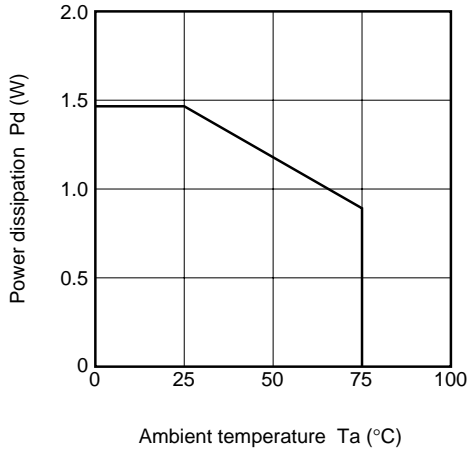

Output Saturation Voltage Collector Current Characteristics

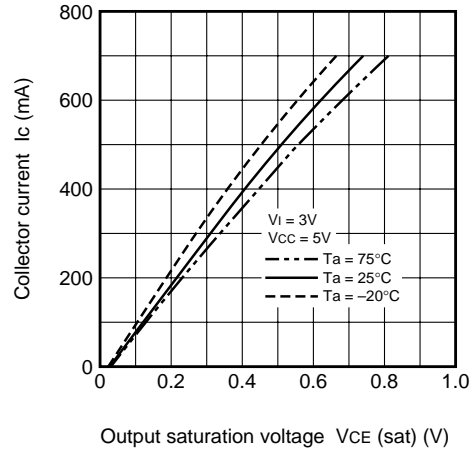

Duty-Cycle-Collector Characteristics

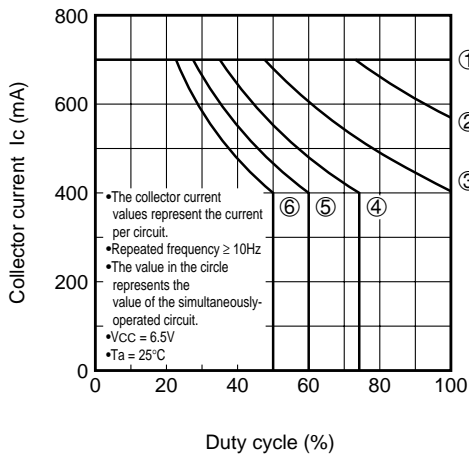

Duty-Cycle-Collector Characteristics

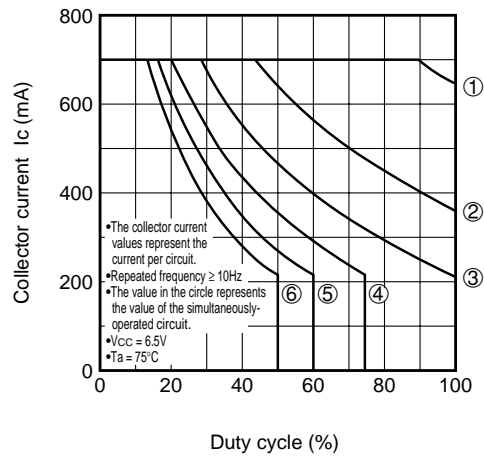

DC Amplification Factor Collector Current Characteristics

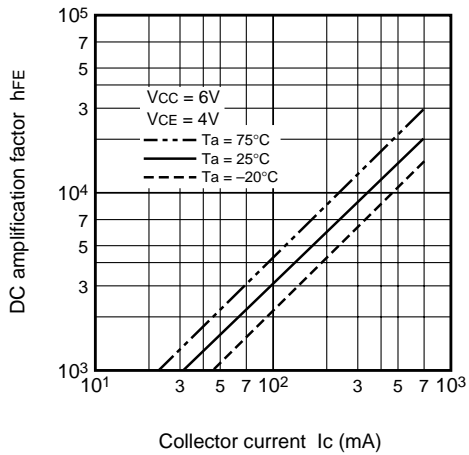

Grounded Emitter Transfer Characteristics

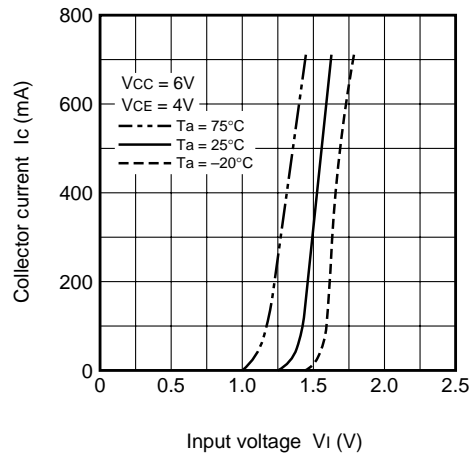

Input Characteristics

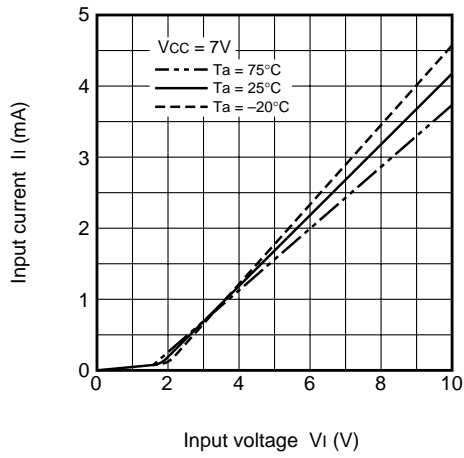

Supply Current Characteristics

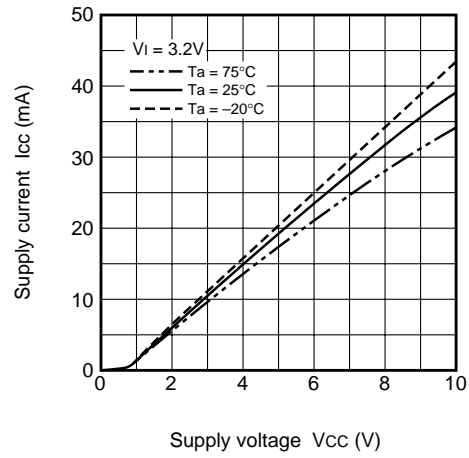

Clamping Diode Characteristics

