



# LA4508

## 8.5W 2-Channel AF Power Amplifier

### Features

- Low idling current (20mA/2 channels).
- Output power 8.5W × 2 typ. ( $R_L=3\Omega$ ).
- High ripple rejection (60dB at steady state).
- Small pop noise at the time of power supply ON.
- Thermal protector.
- Adoption of SIP14H ( $\theta_{j-c}=3^\circ\text{C/W}$ ) facilitates thermal design.

### Package Dimensions

unit:mm

3023A-SIP14H

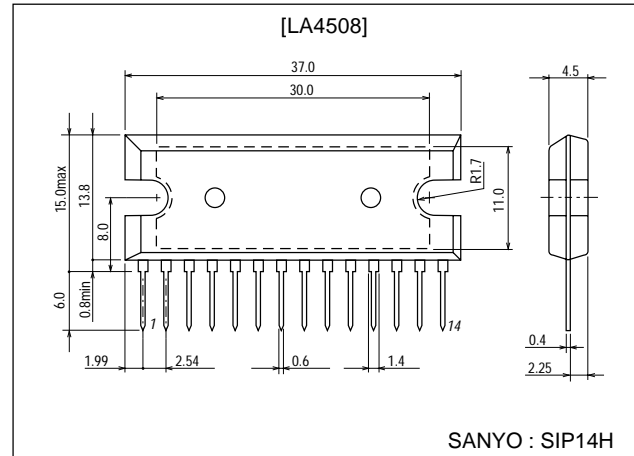

### Specifications

#### Absolute Maximum Ratings at $T_a = 25^\circ\text{C}$

Parameter	Symbol	Conditions	Ratings	Unit
Maximum supply voltage	$V_{CC\text{ max}}$		24	V
Allowable power dissipation	$P_d\text{ max}$	With infinite heat sink	15	W
Maximum output current	$I_O\text{ peak}$	1 channel	2.5	A
Operating temperature	$T_{opr}$		-20 to +75	$^\circ\text{C}$
Storage temperature	$T_{stg}$		-40 to +150	$^\circ\text{C}$

#### Operating Conditions at $T_a = 25^\circ\text{C}$

Parameter	Symbol	Conditions	Ratings	Unit
Recommended supply voltage	$V_{CC}$		15	V
Operating voltage range	$V_{CC}^*$	$P_d\text{ max}$ must not be exceeded.	9 to 23	V
Recommended load resistance	$R_L$	2 channels	3	$\Omega$

#### Operating Characteristics at $T_a = 25^\circ\text{C}$ , $V_{CC}=15\text{V}$ , $R_L=3\Omega$ (2 channels), $f=1\text{kHz}$ , $R_g=600\Omega$ ,

See specified test circuit.

Parameter	Symbol	Conditions	Ratings			Unit
			min	typ	max	
Quiescent current	$I_{CCO}$	2 channels	10	20	30	mA
Voltage gain	VG		42	44	46	dB
Voltage gain difference	$\Delta\text{VG}$	ch1, ch2			$\pm 1$	dB
Output power	$P_O$	THD=10%	7.5	8.5		W

Continued on next page.

■ Any and all SANYO products described or contained herein do not have specifications that can handle applications that require extremely high levels of reliability, such as life-support systems, aircraft's control systems, or other applications whose failure can be reasonably expected to result in serious physical and/or material damage. Consult with your SANYO representative nearest you before using any SANYO products described or contained herein in such applications.

■ SANYO assumes no responsibility for equipment failures that result from using products at values that exceed, even momentarily, rated values (such as maximum ratings, operating condition ranges, or other parameters) listed in products specifications of any and all SANYO products described or contained herein.

**SANYO Electric Co., Ltd. Semiconductor Company**

TOKYO OFFICE Tokyo Bldg., 1-10, 1 Chome, Ueno, Taito-ku, TOKYO, 110-8534 JAPAN

21500TN (KT)/D0994JN/O147KI/8056/8064/N283 No.1440-1/7

# LA4508

Continued from preceding page.

Parameter	Symbol	Conditions	Ratings			Unit
			min	typ	max	
Total harmonic distortion	THD	$V_O=2V$		0.15	1.0	%
Input resistance	$r_i$			30		k $\Omega$
Output noise voltage	$V_{NO1}$	$R_g=0, f=20\text{Hz to }20\text{kHz, B.P.F}$		0.2	0.5	mV
	$V_{NO2}$	$R_g=10\text{k}\Omega, f=20\text{Hz to }20\text{kHz, B.P.F}$		0.3	1.0	mV
Ripple rejection	$R_r$		45	60		dB
Channel separation	ch sep		45	55		dB

## Equivalent Circuit

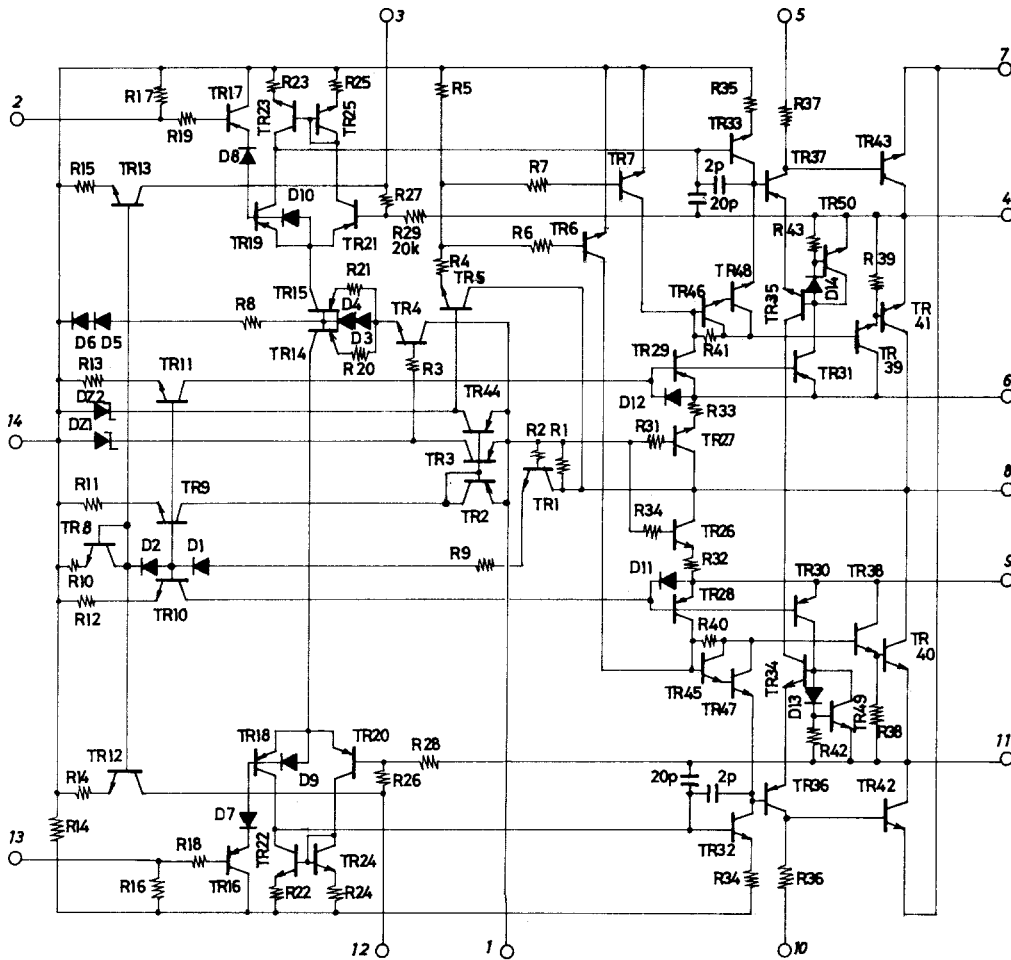

Unit (resistance:  $\Omega$ , capacitance: F)

## Sample Application Circuit

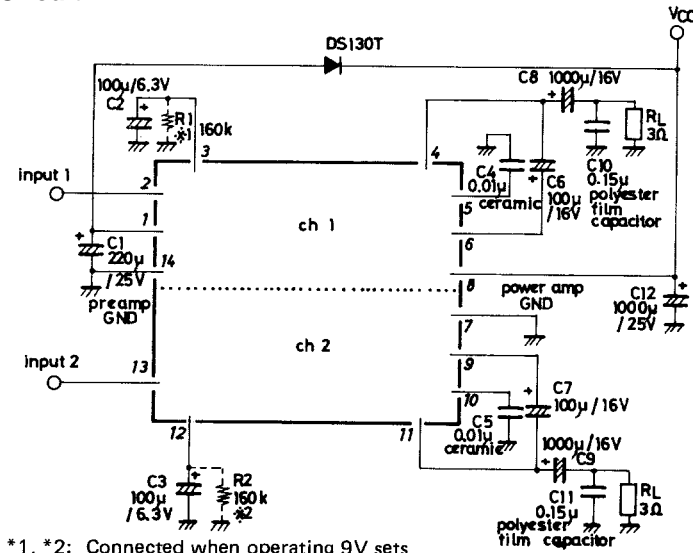

Sample Printed Circuit Pattern (Cu-foiled area)

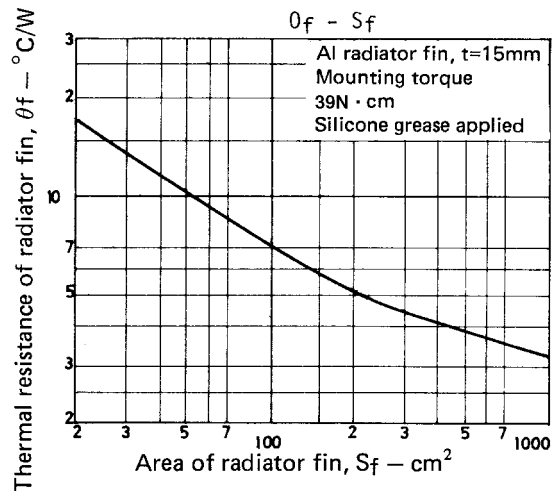
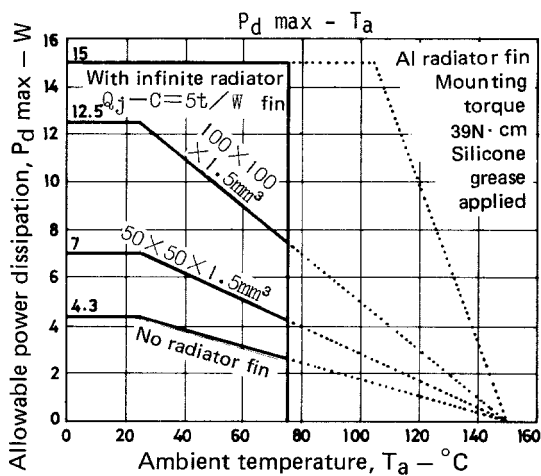
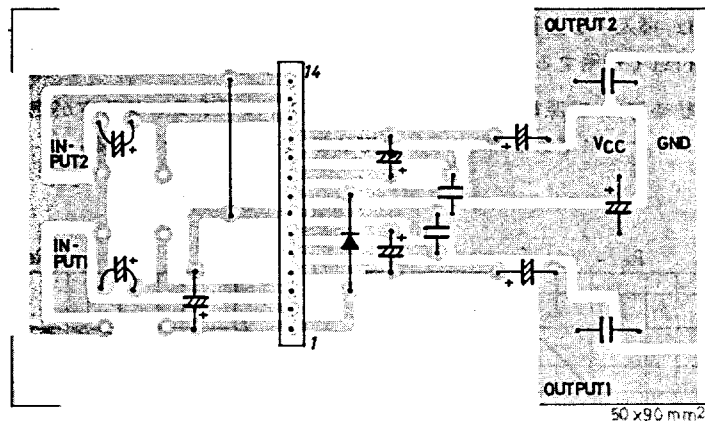

Description of External Parts

- $C_1$  : Decoupling capacitor  
Used for the ripple filter. Since the rejection effect is saturated at a certain capacity, it is meaningless to increase the capacity more than needed. This capacitor, being also used for the time constant of the pop noise preventer, affects the starting time. Too small a capacity makes the pop noise level higher.  
(Recommended value : 100 $\mu\text{F}$  to 330 $\mu\text{F}$ )
- $C_2$  ( $C_3$ ) : Feedback capacitor  
Since the low cutoff frequency depends on this feedback capacitor, the required bandwidth must be considered before determining the value of this feedback capacitor. This feedback capacitor also affects the starting time.
- $C_4$  ( $C_5$ ) : Switching distortion suppressing capacitor  
Used to suppress switching distortion which often appears at high frequencies in overinput mode. The recommended value is 0.01 $\mu\text{F}$  (ceramic capacitor).
- $C_6$  ( $C_7$ ) : Bootstrap capacitor  
The output at low frequencies depends on this capacitor. If the capacity is decreased, the output at low frequencies goes lower. 47 $\mu\text{F}$  min. is required. (This, however, does not apply if load  $R_L$  is light.)
- $C_8$  ( $C_9$ ) : Output capacitor  
The low cutoff frequency depends on this output capacitor. (Refer to the characteristic graph.)
- $C_{10}$  ( $C_{11}$ ) : Oscillation blocking capacitor  
Polyester film capacitor, being excellent in temperature characteristic, frequency characteristic, is used. The use of an aluminum electrolytic capacitor or ceramic capacitor may cause oscillation to occur at low temperatures.
- $C_{12}$  : Power source capacitor.  
This power source capacitor must accommodate loads (motor, etc.) in the power line or ripple in the transformer output. This recommended value is 1000 $\mu\text{F}$  to 2200 $\mu\text{F}$ .

Continued on next page.

Continued from preceding page.

$R_1 (R_2)$  : Normally, this resistor is required.

If the IC is used at  $V_{CC}=9V$  or thereabouts, clip balance may be disturbed. This resistor can be used to correct such disturbance.

$D_1$  :

When a motor is started, or in similar modes, the supply voltage drops abruptly, causing the filter transistor to be saturated. This diode is a bypass diode and can be used to prevent such saturation from occurring. Whether or not to use this diode depends on the set to be made.

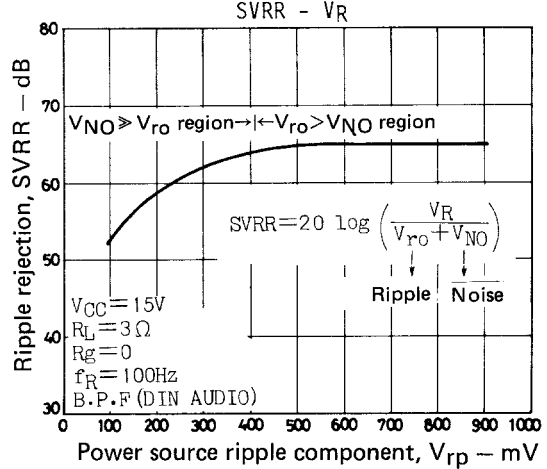
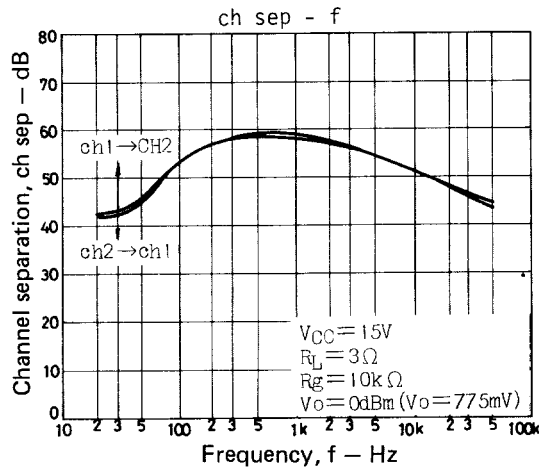
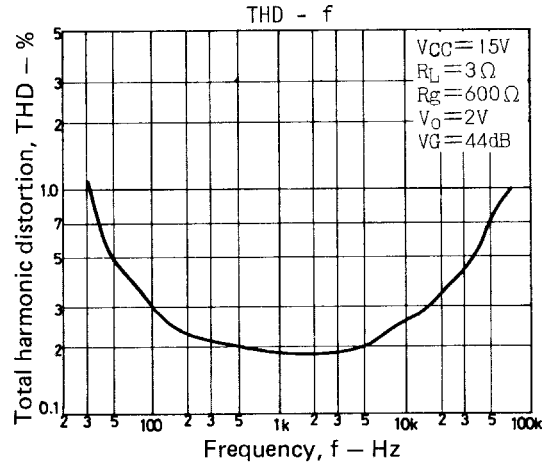
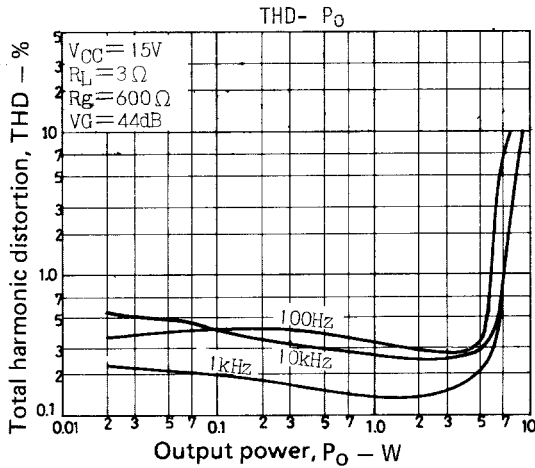
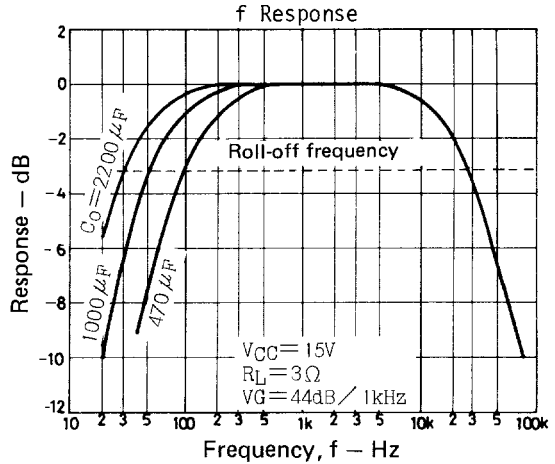
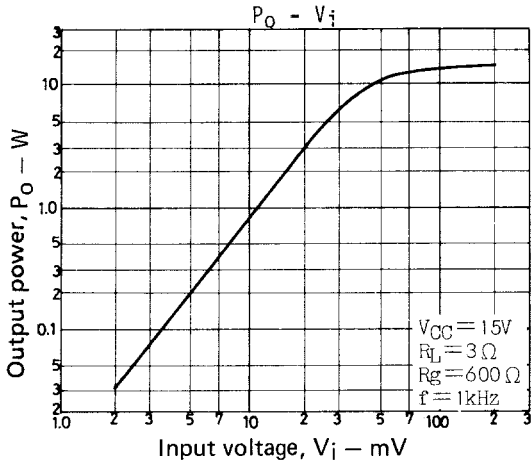

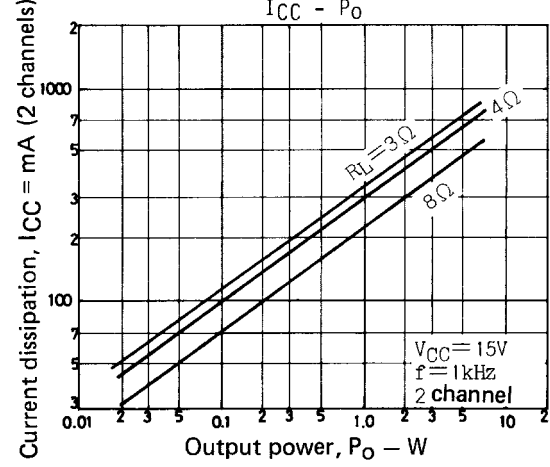
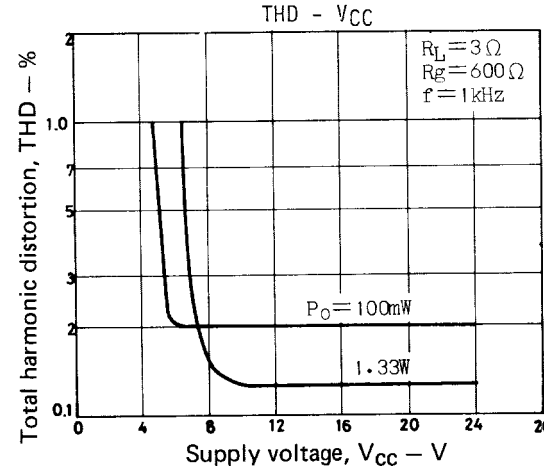
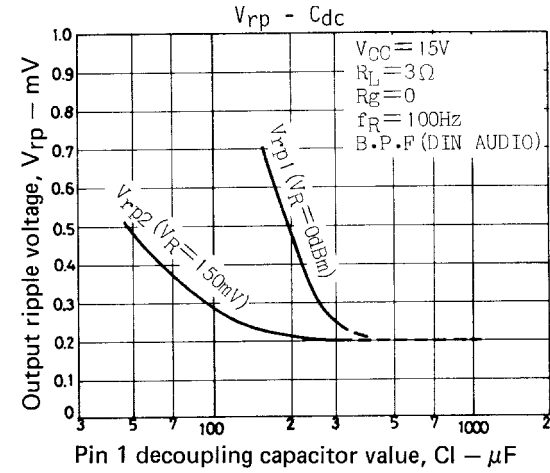
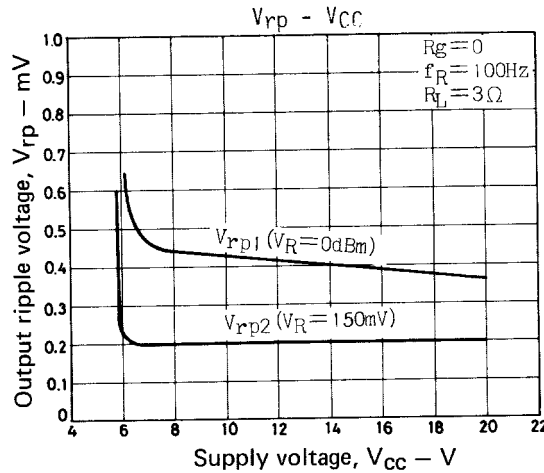
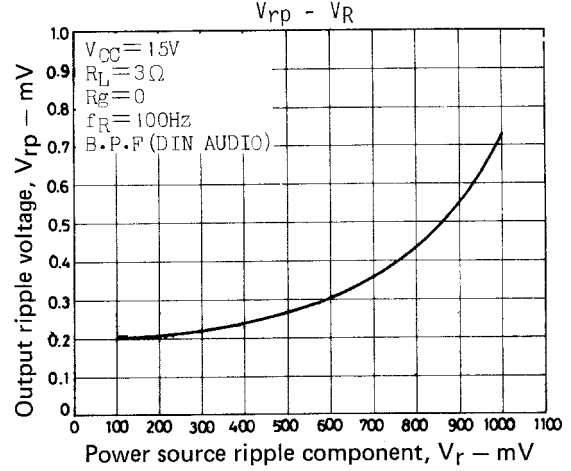
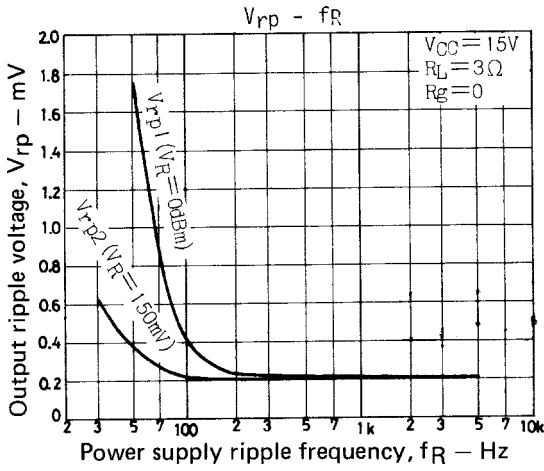
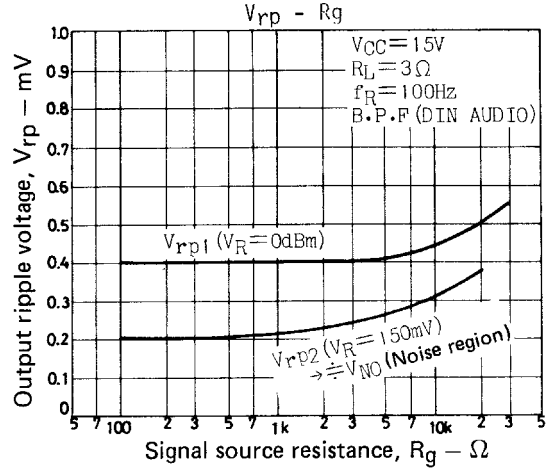
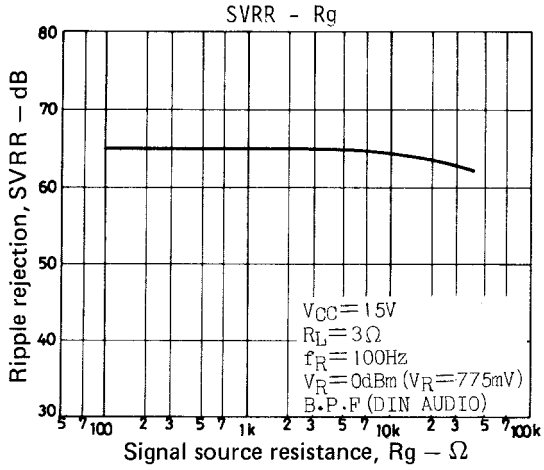

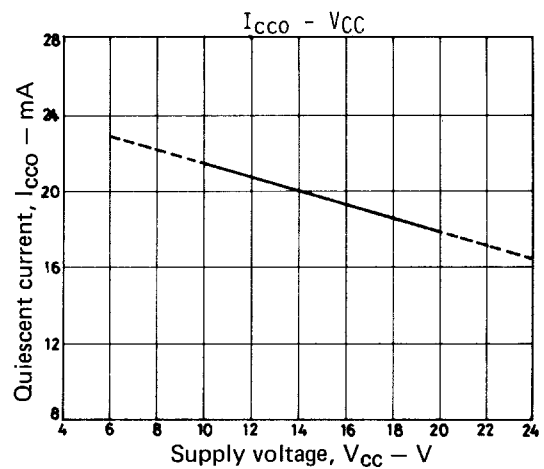
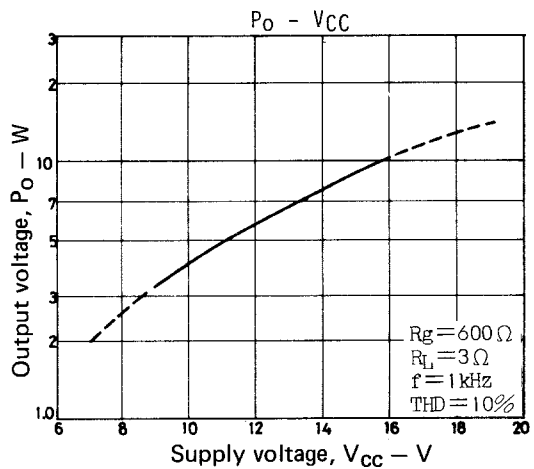
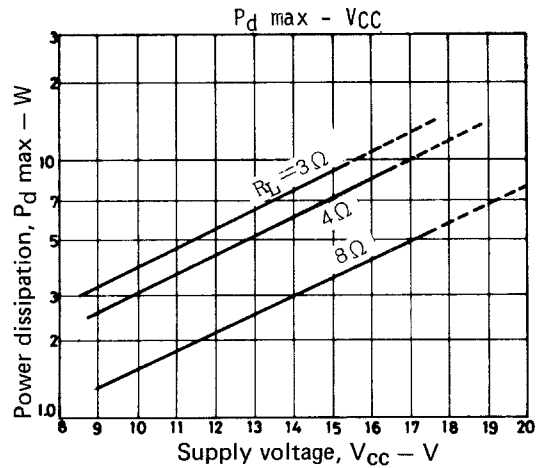
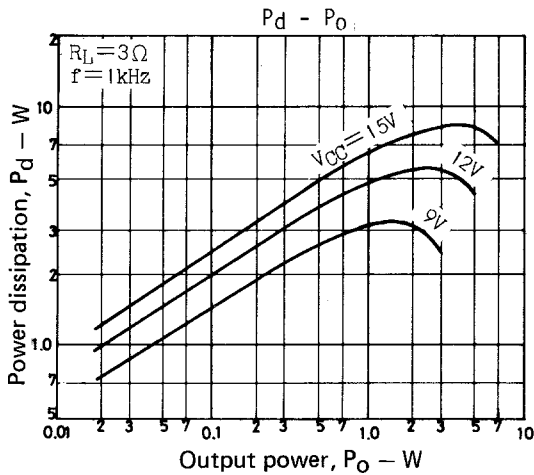

**Proper Cares in Using IC**

1. If the IC is used in the vicinity of the maximum rating, even a slight variation in conditions may cause the maximum rating to be exceeded, thereby leading to breakdown. Allow an ample margin of variation for supply voltage, etc. and use the IC in the range where the maximum ratings is not exceeded.
2. Pin-to-pin short, inverted insertion  
If supply voltage is applied when the space between pins is shorted, breakdown or deterioration may occur. When mounting the IC on the board or applying supply voltage, make sure that the space between pins is not shorted with solder, etc. If the IC is inserted inversely, it may be broken down momentarily because of pin 7 : Power Gnd, pin 8 :  $V_{CC}$ .
3. Load short  
If the IC is used with the load shorted for a long time, breakdown or deterioration may occur. Be sure not to short the load.
4. Change in closed-loop gain  
By connecting  $R_{NF}$  in series with pins 3, 12 (NF pin), the gain can be reduced, but the following must be noted.
  - a. If  $R_{NF}$  is connected, the ripple bypass effect brought about by the NF capacitor is lessened, leading to insufficient ripple rejection.
  - b. Do not operate at 40dB or less so that stable oscillation is maintained.
5. When the IC is used in radios or radio-cassette tape recorders, keep a good distance between IC and bar antenna.  
A capacitor of  $0.022\mu F$  or more (polyester film capacitor) connected between pins 9 and 7 and between pins 6 and 7 acts effectively against radiation to the SW band.
6. Printed circuit board  
When making the board, refer to the sample printed circuit pattern. No feedback loop must be formed between input and output and make the line thick and short so that no common resistor exists between pre-GND and power-GND.

Continued on next page.

Continued from preceding page.

7. Some plug jacks to be used for connecting to the external speaker are such that both poles are short-circuited once when connecting. In this case, the load is short-circuited, which may break down the IC.
8. Improvement in reduced voltage characteristic (Reference example).

By connecting parts as shown below, distortion-free operation can be performed at a supply voltage down to  $V_{CC}=4.5V$  or thereabouts. The capacitor of  $100\mu F$  is connected to suppress pop noise.

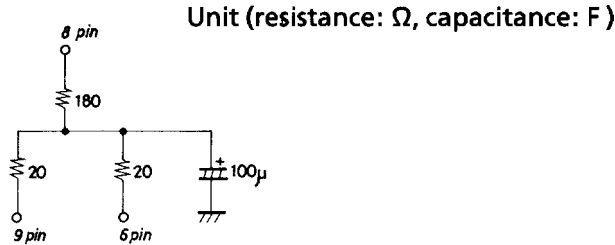

**Proper Cares in Mousing Radiator Fin**

1. The mounting torque is in the range of 39 to 59N · cm.
2. The distance between screw holes of the radiator fin must coincide with the distance between screw holes of the IC. With case outline dimensions L and R referred to, the screws must be tightened with the distance between them as close to each other as possible.

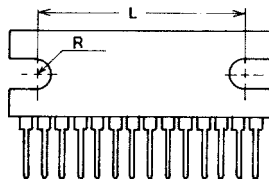

3. The screw to be used must have a head equivalent to the truss machine screw or binder machine screw defined by JIS. Washers must be also used to protect the IC case.
4. No foreign matter such as cutting particles shall exist between heat sink and radiator fin. When applying grease on the junction surface, it must be applied uniformly on the whole surface.
5. IC lead pins are soldered to the printed circuit board after the radiator fin is mounted on the IC.

- Specifications of any and all SANYO products described or contained herein stipulate the performance, characteristics, and functions of the described products in the independent state, and are not guarantees of the performance, characteristics, and functions of the described products as mounted in the customer's products or equipment. To verify symptoms and states that cannot be evaluated in an independent device, the customer should always evaluate and test devices mounted in the customer's products or equipment.
- SANYO Electric Co., Ltd. strives to supply high-quality high-reliability products. However, any and all semiconductor products fail with some probability. It is possible that these probabilistic failures could give rise to accidents or events that could endanger human lives, that could give rise to smoke or fire, or that could cause damage to other property. When designing equipment, adopt safety measures so that these kinds of accidents or events cannot occur. Such measures include but are not limited to protective circuits and error prevention circuits for safe design, redundant design, and structural design.
- In the event that any or all SANYO products(including technical data, services) described or contained herein are controlled under any of applicable local export control laws and regulations, such products must not be exported without obtaining the export license from the authorities concerned in accordance with the above law.
- No part of this publication may be reproduced or transmitted in any form or by any means, electronic or mechanical, including photocopying and recording, or any information storage or retrieval system, or otherwise, without the prior written permission of SANYO Electric Co., Ltd.
- Any and all information described or contained herein are subject to change without notice due to product/technology improvement, etc. When designing equipment, refer to the "Delivery Specification" for the SANYO product that you intend to use.
- Information (including circuit diagrams and circuit parameters) herein is for example only ; it is not guaranteed for volume production. SANYO believes information herein is accurate and reliable, but no guarantees are made or implied regarding its use or any infringements of intellectual property rights or other rights of third parties.

This catalog provides information as of February, 2000. Specifications and information herein are subject to change without notice.