



# 80mW, Fixed-Gain, DirectDrive, Stereo Headphone Amplifier with Shutdown

## General Description

The MAX4411 fixed-gain, stereo headphone amplifier is designed for portable equipment where board space is at a premium. The MAX4411 uses a unique, patented DirectDrive architecture to produce a ground-referenced output from a single supply, eliminating the need for large DC-blocking capacitors, saving cost, board space, and component height. Additionally, the gain of the amplifier is set internally (-1.5V/V, MAX4411 and -2V/V, MAX4411B), further reducing component count.

The MAX4411 delivers up to 80mW per channel into a 16Ω load and has low 0.003% THD+N. An 86dB at 217Hz power-supply rejection ratio (PSRR) allows this device to operate from noisy digital supplies without an additional linear regulator. The MAX4411 includes ±8kV ESD protection on the headphone outputs. Comprehensive click-and-pop circuitry suppresses audible clicks and pops on startup and shutdown. Independent left/right, low-power shutdown controls make it possible to optimize power savings in mixed-mode, mono/stereo applications.

The MAX4411 operates from a single 1.8V to 3.6V supply, consumes only 5mA of supply current, has short-circuit and thermal-overload protection, and is specified over the extended -40°C to +85°C temperature range. The MAX4411 is available in a tiny (2mm × 2mm × 0.6mm), 16-bump chip-scale package (UCSP™) and a 20-pin thin QFN package (4mm × 4mm × 0.8mm).

## Applications

Notebook PCs	MP3 Players
Cellular Phones	Smart Phones
PDA's	Portable Audio Equipment

UCSP is a trademark of Maxim Integrated Products, Inc.

## Features

- ◆ No Bulky DC-Blocking Capacitors Required
- ◆ Fixed -1.5V/V Gain Eliminates External Feedback Network
  - MAX4411: -1.5V/V
  - MAX4411B: -2V/V
- ◆ Ground-Referenced Outputs Eliminate DC-Bias Voltages on Headphone Ground Pin
- ◆ No Degradation of Low-Frequency Response Due to Output Capacitors
- ◆ 80mW per Channel into 16Ω
- ◆ Low 0.003% THD+N
- ◆ High PSRR (86dB at 217Hz)
- ◆ Integrated Click-and-Pop Suppression
- ◆ 1.8V to 3.6V Single-Supply Operation
- ◆ Low Quiescent Current (5mA)
- ◆ Independent Left/Right, Low-Power Shutdown Controls
- ◆ Short-Circuit and Thermal-Overload Protection
- ◆ ±8kV ESD-Protected Amplifier Outputs
- ◆ Available in Space-Saving Packages
  - 16-Bump UCSP (2mm × 2mm × 0.6mm)
  - 20-Pin Thin QFN (4mm × 4mm × 0.8mm)

## Ordering Information

PART	TEMP RANGE	PIN/BUMP-PACKAGE	GAIN (V/V)
MAX4411EBE-T	-40°C to +85°C	16 UCSP-16	-1.5
MAX4411ETP	-40°C to +85°C	20 Thin QFN	-1.5
MAX4411BEBE-T	-40°C to +85°C	16 UCSP-16	-2
MAX4411BETP	-40°C to +85°C	20 Thin QFN	-2

## Functional Diagram

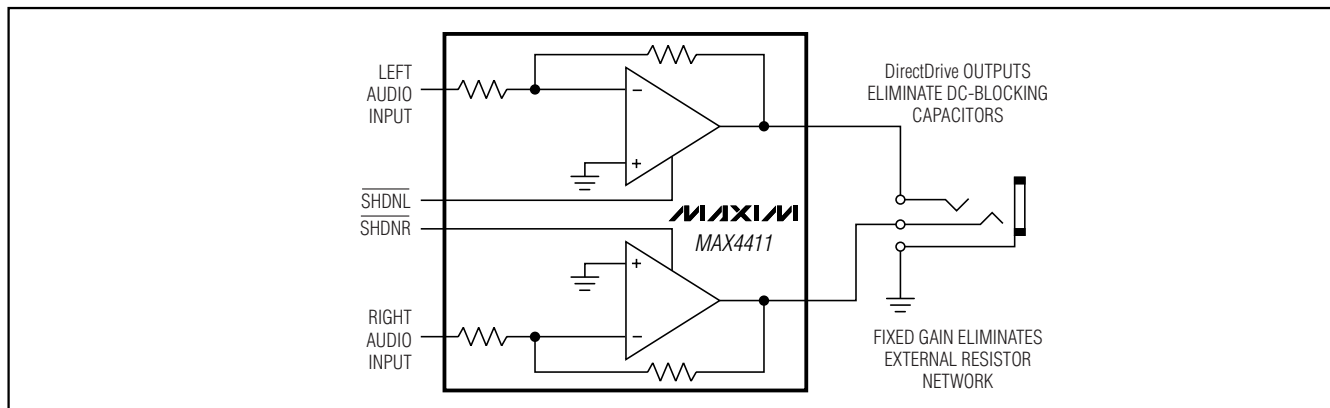

Pin Configurations and Typical Application Circuit appear at end of data sheet.



# 80mW, Fixed-Gain, DirectDrive, Stereo Headphone Amplifier with Shutdown

## ABSOLUTE MAXIMUM RATINGS

PGND to SGND .....	-0.3V to +0.3V	Output Short Circuit to GND or V <sub>DD</sub> .....	Continuous
PV <sub>DD</sub> to SV <sub>DD</sub> .....	-0.3V to +0.3V	Continuous Power Dissipation (T <sub>A</sub> = +70°C)	
PV <sub>SS</sub> to SV <sub>SS</sub> .....	-0.3V to +0.3V	16-Bump UCSP (derate 7.4mW/°C above +70°C).....	589mW
PV <sub>DD</sub> and SV <sub>DD</sub> to PGND or SGND .....	-0.3V to +4V	20-Pin Thin QFN (derate 16.9mW/°C above +70°C) ..	1349mW
PV <sub>SS</sub> and SV <sub>SS</sub> to PGND or SGND .....	-4V to +0.3V	Junction Temperature .....	+150°C
IN <sub>-</sub> to SGND .....	(SV <sub>SS</sub> - 0.3V) to (SV <sub>DD</sub> + 0.3V)	Operating Temperature Range .....	-40°C to +85°C
$\overline{\text{SHDN}}_{-}$ to SGND .....	(SGND - 0.3V) to (SV <sub>DD</sub> + 0.3V)	Storage Temperature Range .....	-65°C to +150°C
OUT <sub>-</sub> to SGND .....	(SV <sub>SS</sub> - 0.3V) to (SV <sub>DD</sub> + 0.3V)	Bump Temperature (soldering)	
C1P to PGND .....	(PGND - 0.3V) to (PV <sub>DD</sub> + 0.3V)	Reflow .....	+230°C
C1N to PGND .....	(PV <sub>SS</sub> - 0.3V) to (PGND + 0.3V)	Lead Temperature (soldering, 10s) .....	+300°C

Stresses beyond those listed under "Absolute Maximum Ratings" may cause permanent damage to the device. These are stress ratings only, and functional operation of the device at these or any other conditions beyond those indicated in the operational sections of the specifications is not implied. Exposure to absolute maximum rating conditions for extended periods may affect device reliability.

## ELECTRICAL CHARACTERISTICS

(PV<sub>DD</sub> = SV<sub>DD</sub> = 3V, PGND = SGND = 0V,  $\overline{\text{SHDN}}_{-}$  =  $\overline{\text{SHDN}}_{+}$  = SV<sub>DD</sub>, C1 = C2 = 2.2 $\mu$ F, C<sub>IN</sub> = 1 $\mu$ F, R<sub>L</sub> =  $\infty$ , T<sub>A</sub> = T<sub>MIN</sub> to T<sub>MAX</sub>, unless otherwise noted. Typical values are at T<sub>A</sub> = +25°C.) (Note 1)

PARAMETER	SYMBOL	CONDITIONS		MIN	TYP	MAX	UNITS
Supply Voltage Range	V <sub>DD</sub>	Guaranteed by PSRR test		1.8		3.6	V
Quiescent Supply Current	I <sub>DD</sub>	One channel enabled			3.2		mA
		Two channels enabled			5	8.4	
Shutdown Supply Current	I $\overline{\text{SHDN}}$	$\overline{\text{SHDN}}_{-}$ = $\overline{\text{SHDN}}_{+}$ = GND			6	10	$\mu$ A
$\overline{\text{SHDN}}_{-}$ Thresholds		V <sub>IH</sub>		0.7 x SV <sub>DD</sub>			V
		V <sub>IL</sub>				0.3 x SV <sub>DD</sub>	
$\overline{\text{SHDN}}_{-}$ Input Leakage Current				-1		+1	$\mu$ A
$\overline{\text{SHDN}}_{-}$ to Full Operation	t <sub>SON</sub>				175		$\mu$ s
<b>CHARGE PUMP</b>							
Oscillator Frequency	f <sub>OSC</sub>			272	320	368	kHz
<b>AMPLIFIERS</b>							
Voltage Gain	A <sub>v</sub>	MAX4411		-1.55	-1.5	-1.45	V/V
		MAX4411B		-2.1	-2	-1.9	
Gain Match	$\Delta$ A <sub>v</sub>				1		%
Total Output Offset Voltage	V <sub>OS</sub>	Input AC-coupled	MAX4411		0.7	2.8	mV
			MAX4411B		0.75	3.0	
Input Resistance	R <sub>IN</sub>			10	14	19	k $\Omega$
Power-Supply Rejection Ratio	PSRR	1.8V $\leq$ V <sub>DD</sub> $\leq$ 3.6V, MAX4411	DC (Note 2)	72	86		dB
			V <sub>DD</sub> = 3.0V, 200mV <sub>p-p</sub> ripple, MAX4411 (Note 3)	f <sub>RIPPLE</sub> = 217Hz		86	
		f <sub>RIPPLE</sub> = 1kHz			75		
		f <sub>RIPPLE</sub> = 20kHz			53		

# 80mW, Fixed-Gain, DirectDrive, Stereo Headphone Amplifier with Shutdown

## ELECTRICAL CHARACTERISTICS (continued)

( $P_{VDD} = S_{VDD} = 3V$ ,  $P_{GND} = S_{GND} = 0V$ ,  $\overline{SHDNL} = \overline{SHDNR} = S_{VDD}$ ,  $C_1 = C_2 = 2.2\mu F$ ,  $C_{IN} = 1\mu F$ ,  $R_L = \infty$ ,  $T_A = T_{MIN}$  to  $T_{MAX}$ , unless otherwise noted. Typical values are at  $T_A = +25^\circ C$ .) (Note 1)

PARAMETER	SYMBOL	CONDITIONS		MIN	TYP	MAX	UNITS	
Power-Supply Rejection Ratio	PSRR	$1.8V \leq V_{DD} \leq 3.6V$ , MAX4411B	DC (Note 2)	69	86		dB	
			$V_{DD} = 3.0V$ , 200mVp-p ripple, MAX4411B (Note 3)	$f_{RIPPLE} = 217Hz$		86		
			$f_{RIPPLE} = 1kHz$		73			
Output Power	$P_{OUT}$	THD+N $\leq 1\%$ $T_A = +25^\circ C$	$R_L = 32\Omega$		65		mW	
			$R_L = 16\Omega$	55	80			
Total Harmonic Distortion Plus Noise	THD+N	$f_{IN} = 1kHz$	$R_L = 32\Omega$ , $P_{OUT} = 50mW$		0.003		%	
			$R_L = 16\Omega$ , $P_{OUT} = 60mW$		0.004			
Signal-to-Noise Ratio	SNR	$R_L = 32\Omega$ , $P_{OUT} = 20mW$ , $f_{IN} = 1kHz$ , BW = 22Hz to 22kHz	MAX4411		94		dB	
			MAX4411B		95			
Slew Rate	SR				0.8		V/ $\mu s$	
Maximum Capacitive Load	$C_L$	No sustained oscillations			150		pF	
Crosstalk		$R_L = 16\Omega$ , $P_{OUT} = 1.6mW$ , $f_{IN} = 10kHz$			90		dB	
Thermal Shutdown Threshold					140		$^\circ C$	
Thermal Shutdown Hysteresis					15		$^\circ C$	
ESD Protection		Human Body Model (OUTR, OUTL)			$\pm 8$		kV	

**Note 1:** All specifications are 100% tested at  $T_A = +25^\circ C$ ; temperature limits are guaranteed by design.

**Note 2:** Inputs are connected directly to GND.

**Note 3:** Inputs are AC-coupled to ground.

## Typical Operating Characteristics

( $C_1 = C_2 = 2.2\mu F$ , THD+N measurement bandwidth = 22Hz to 22kHz,  $T_A = +25^\circ C$ , unless otherwise noted.)

**TOTAL HARMONIC DISTORTION PLUS NOISE vs. FREQUENCY**

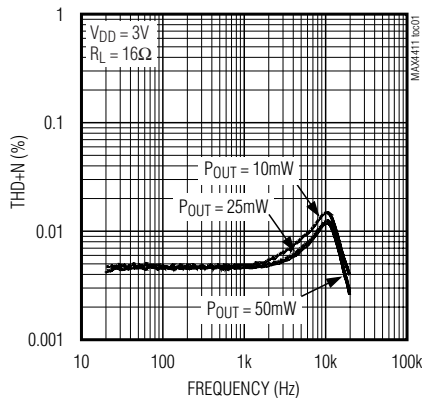

**TOTAL HARMONIC DISTORTION PLUS NOISE vs. FREQUENCY**

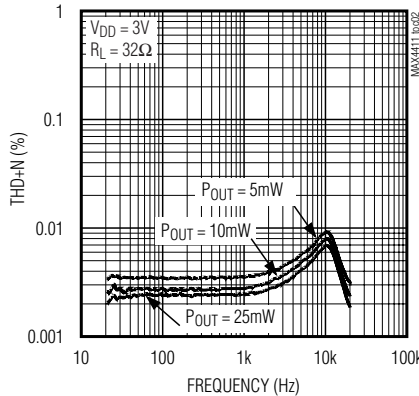

**TOTAL HARMONIC DISTORTION PLUS NOISE vs. FREQUENCY**

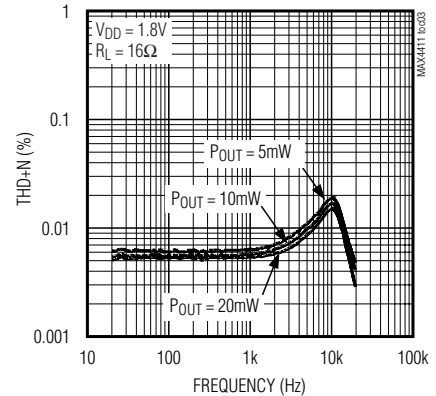

# 80mW, Fixed-Gain, DirectDrive, Stereo Headphone Amplifier with Shutdown

## Typical Operating Characteristics (continued)

(C1 = C2 = 2.2µF, THD+N measurement bandwidth = 22Hz to 22kHz, T<sub>A</sub> = +25°C, unless otherwise noted.)

**TOTAL HARMONIC DISTORTION PLUS NOISE vs. FREQUENCY**

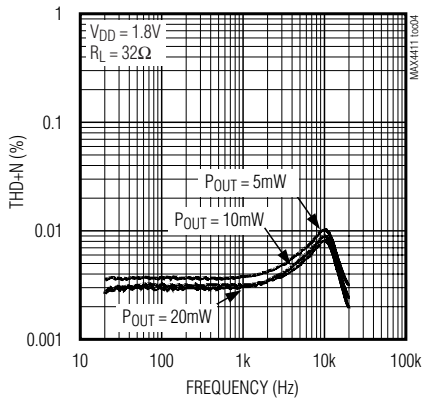

**TOTAL HARMONIC DISTORTION PLUS NOISE vs. OUTPUT POWER**

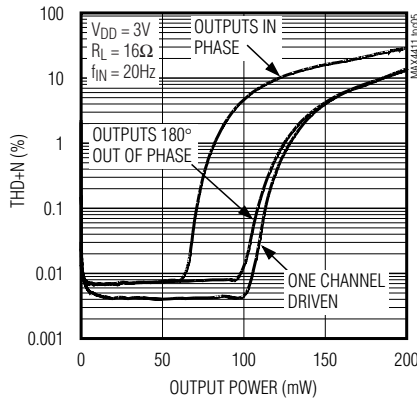

**TOTAL HARMONIC DISTORTION PLUS NOISE vs. OUTPUT POWER**

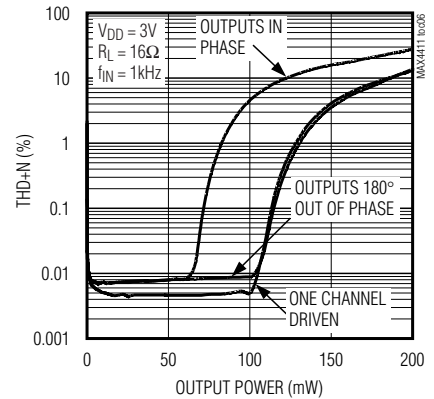

**TOTAL HARMONIC DISTORTION PLUS NOISE vs. OUTPUT POWER**

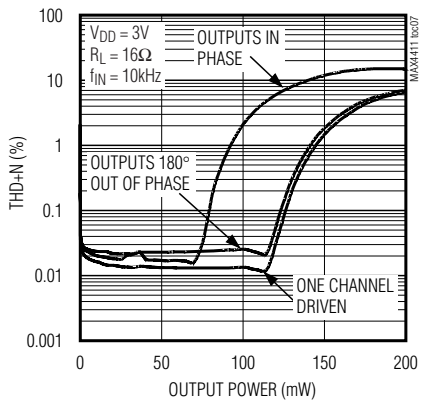

**TOTAL HARMONIC DISTORTION PLUS NOISE vs. OUTPUT POWER**

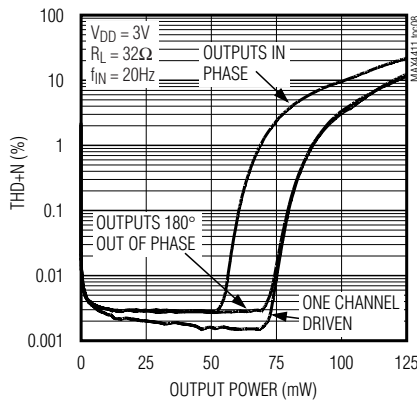

**TOTAL HARMONIC DISTORTION PLUS NOISE vs. OUTPUT POWER**

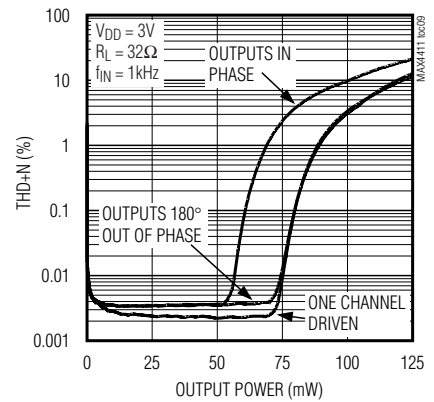

**TOTAL HARMONIC DISTORTION PLUS NOISE vs. OUTPUT POWER**

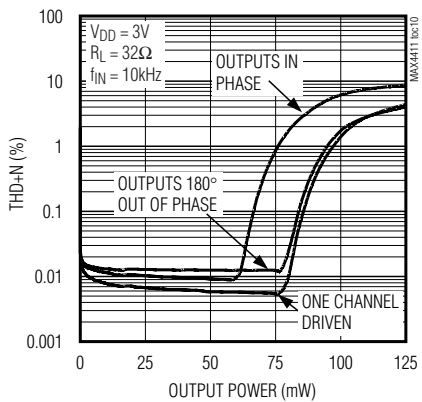

**TOTAL HARMONIC DISTORTION PLUS NOISE vs. OUTPUT POWER**

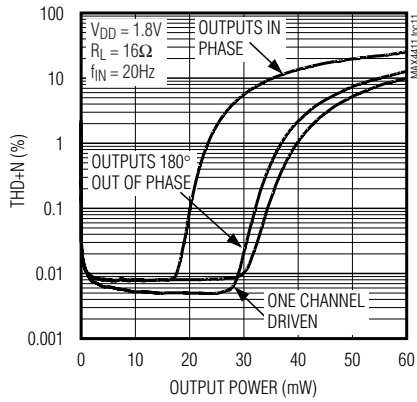

**TOTAL HARMONIC DISTORTION PLUS NOISE vs. OUTPUT POWER**

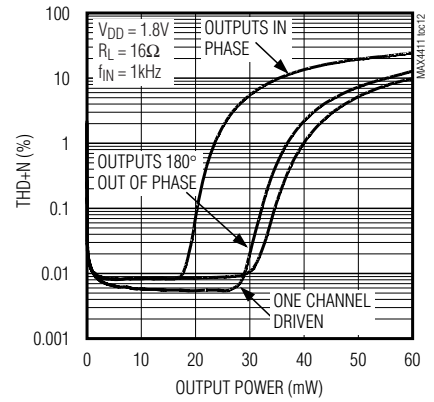

# 80mW, Fixed-Gain, DirectDrive, Stereo Headphone Amplifier with Shutdown

MAX4411

## Typical Operating Characteristics (continued)

(C1 = C2 = 2.2μF, THD+N measurement bandwidth = 22Hz to 22kHz, T<sub>A</sub> = +25°C, unless otherwise noted.)

**TOTAL HARMONIC DISTORTION PLUS NOISE vs. OUTPUT POWER**

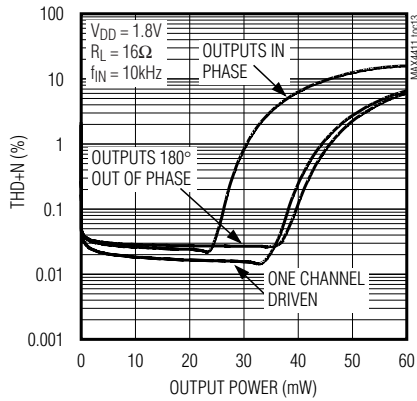

**TOTAL HARMONIC DISTORTION PLUS NOISE vs. OUTPUT POWER**

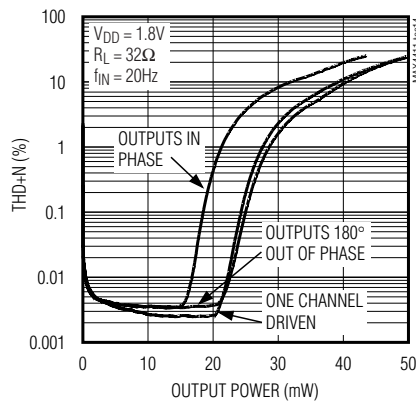

**TOTAL HARMONIC DISTORTION PLUS NOISE vs. OUTPUT POWER**

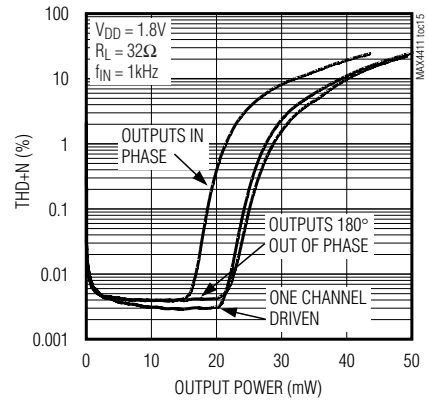

**TOTAL HARMONIC DISTORTION PLUS NOISE vs. OUTPUT POWER**

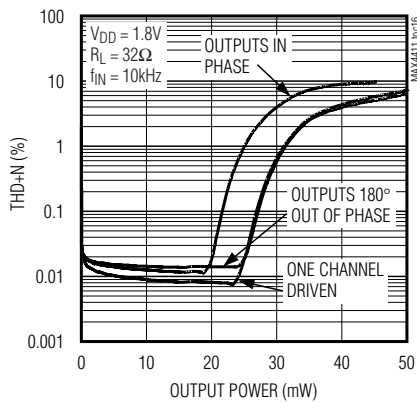

**POWER-SUPPLY REJECTION RATIO vs. FREQUENCY**

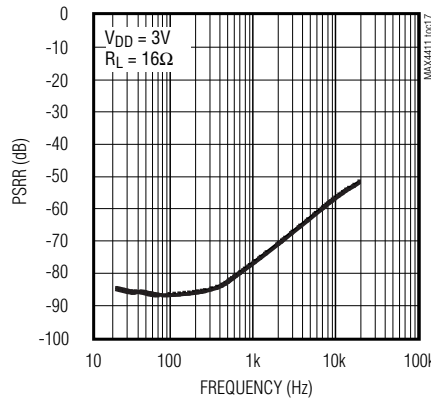

**POWER-SUPPLY REJECTION RATIO vs. FREQUENCY**

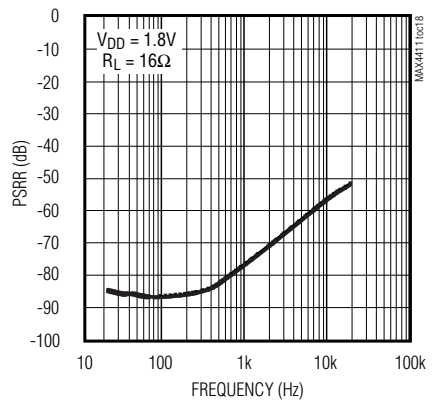

**POWER-SUPPLY REJECTION RATIO vs. FREQUENCY**

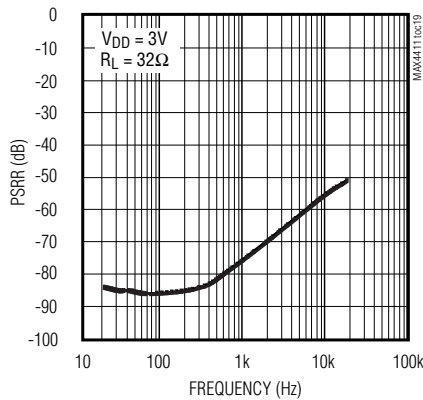

**POWER-SUPPLY REJECTION RATIO vs. FREQUENCY**

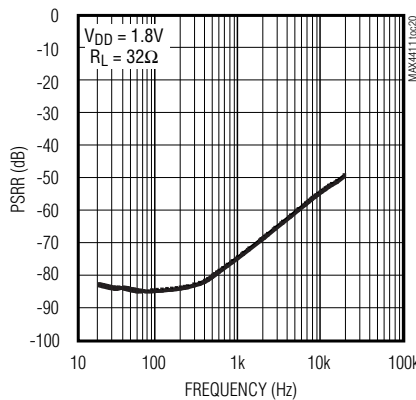

**CROSSTALK vs. FREQUENCY**

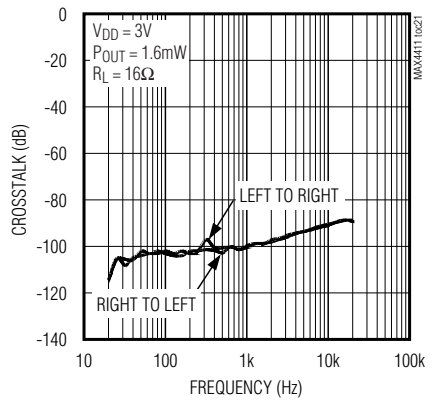

# 80mW, Fixed-Gain, DirectDrive, Stereo Headphone Amplifier with Shutdown

## Typical Operating Characteristics (continued)

(C1 = C2 = 2.2µF, THD+N measurement bandwidth = 22Hz to 22kHz, T<sub>A</sub> = +25°C, unless otherwise noted.)

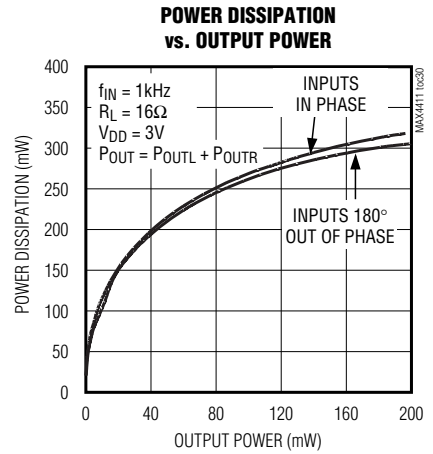
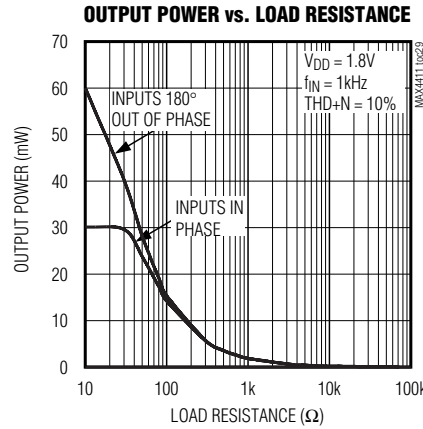
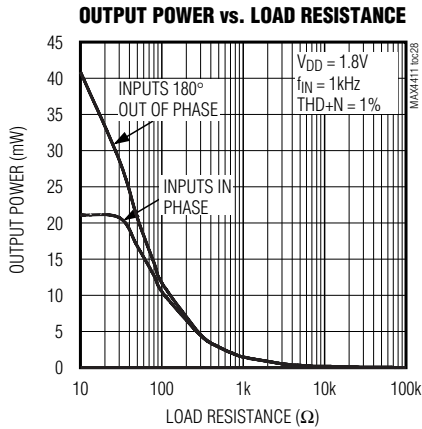
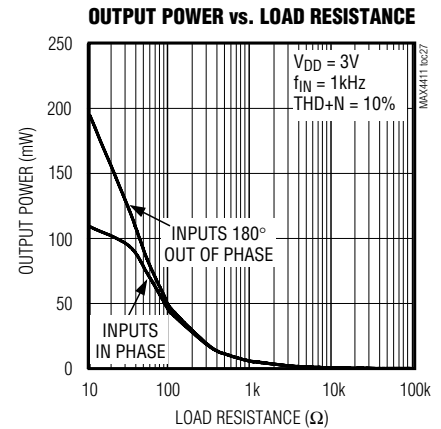
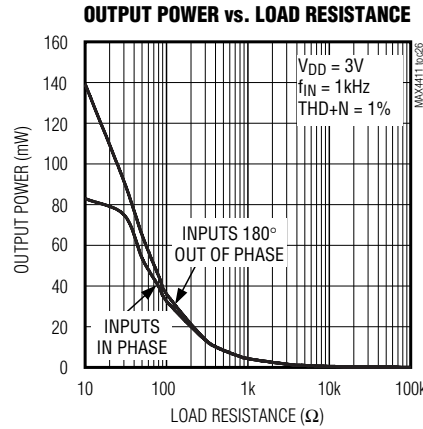
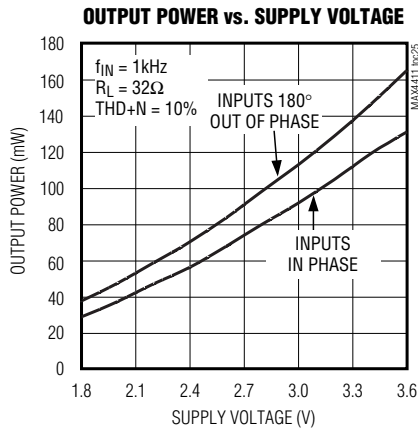
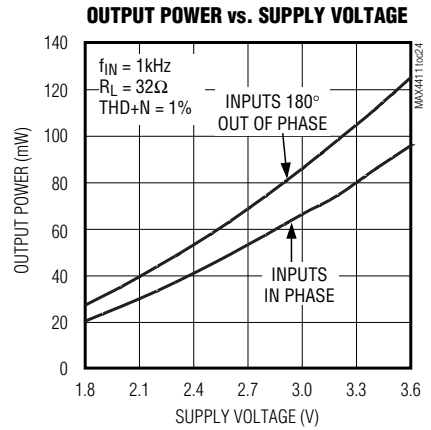
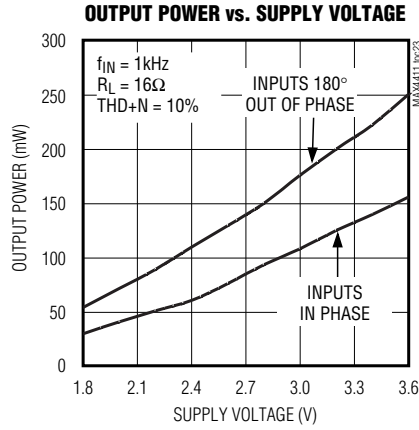
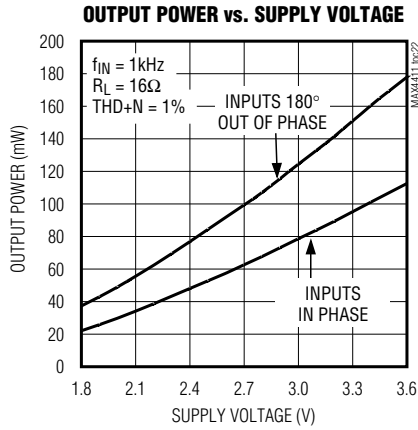

# 80mW, Fixed-Gain, DirectDrive, Stereo Headphone Amplifier with Shutdown

MAX4411

## Typical Operating Characteristics (continued)

(C1 = C2 = 2.2μF, THD+N measurement bandwidth = 22Hz to 22kHz, T<sub>A</sub> = +25°C, unless otherwise noted.)

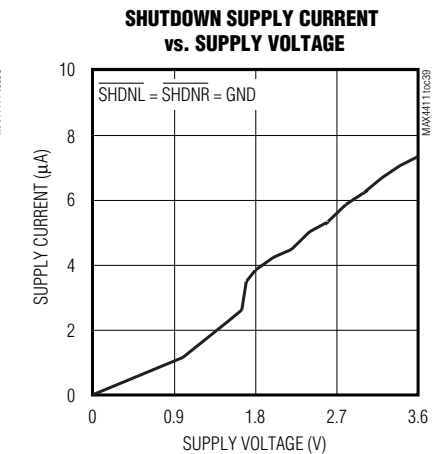
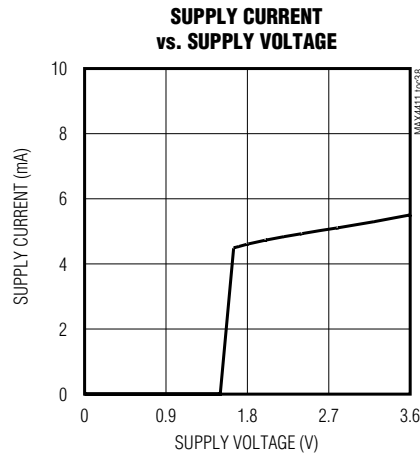
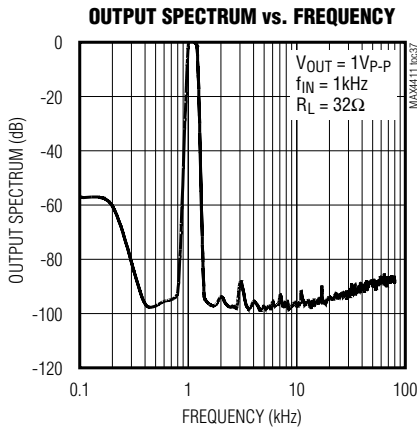
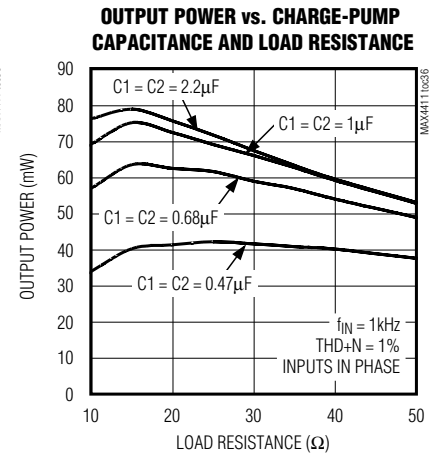
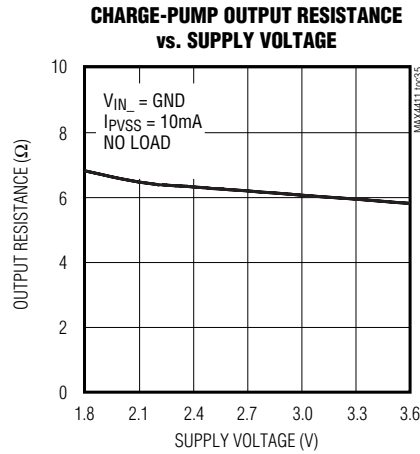
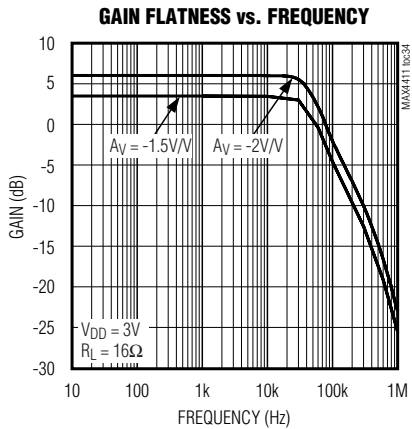
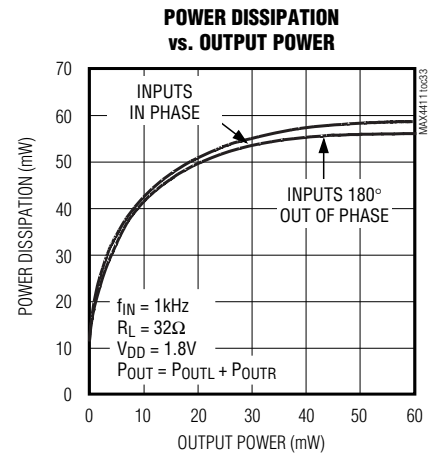
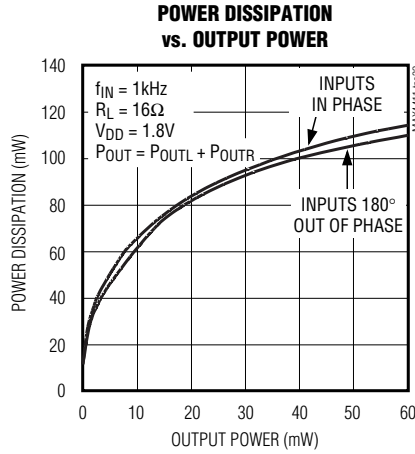
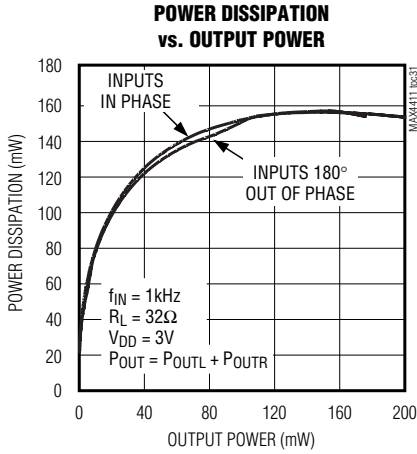

# 80mW, Fixed-Gain, DirectDrive, Stereo Headphone Amplifier with Shutdown

## Typical Operating Characteristics (continued)

(C1 = C2 = 2.2 $\mu$ F, THD+N measurement bandwidth = 22Hz to 22kHz, T<sub>A</sub> = +25°C, unless otherwise noted.)

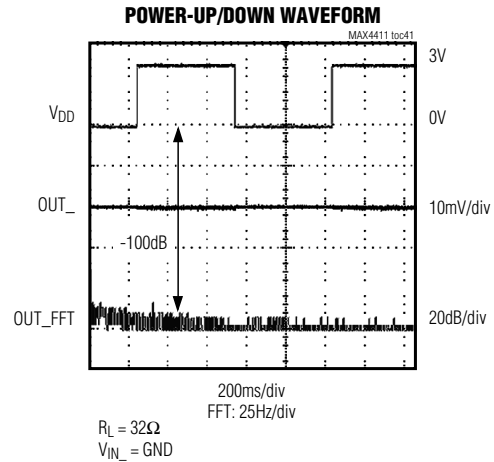
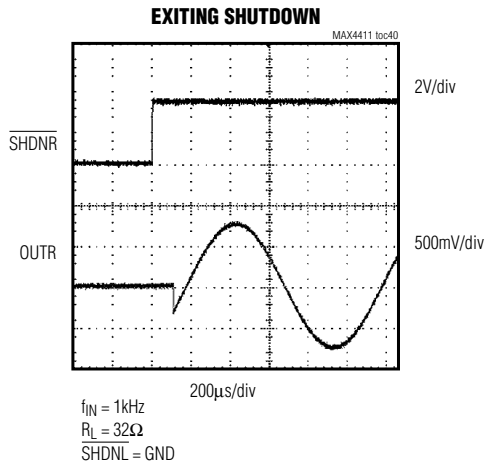

## Pin Description

PIN	BUMP	NAME	FUNCTION
QFN	UCSP		
1	A4	C1P	Flying Capacitor Positive Terminal
2	B4	PGND	Power Ground. Connect to ground (0V).
3	C4	C1N	Flying Capacitor Negative Terminal
4, 6, 8, 12, 16, 20	—	N.C.	No Connection. Not internally connected.
5	D4	PVSS	Charge-Pump Output
7	D3	SVSS	Amplifier Negative Power Supply. Connect to PVSS.
9	D2	OUTL	Left-Channel Output
10	D1	SVDD	Amplifier Positive Power Supply. Connect to positive supply (1.8V to 3.6V).
11	C2	OUTR	Right-Channel Output
13	C1	INL	Left-Channel Audio Input
14	B1	$\overline{\text{SHDNR}}$	Active-Low Right-Channel Shutdown. Connect to V <sub>DD</sub> for normal operation.
15	A1	INR	Right-Channel Audio Input
17	A2	SGND	Signal Ground. Connect to ground (0V).
18	B2	$\overline{\text{SHDNL}}$	Active-Low Left-Channel Shutdown. Connect to V <sub>DD</sub> for normal operation.
19	A3	PVDD	Charge-Pump Power Supply. Powers charge-pump inverter, charge-pump logic, and oscillator. Connect to positive supply (1.8V to 3.6V).
—	—	EP	Exposed Paddle. Leave this connection floating. <b>Do not tie to either GND or V<sub>DD</sub>.</b>



# 80mW, Fixed-Gain, DirectDrive, Stereo Headphone Amplifier with Shutdown

## Detailed Description

The MAX4411 fixed-gain, stereo headphone driver features Maxim's patented DirectDrive architecture, eliminating the large output-coupling capacitors required by conventional single-supply headphone drivers. The device consists of two 80mW Class AB headphone drivers, internal feedback network, undervoltage lockout (UVLO)/shutdown control, charge pump, and comprehensive click-and-pop suppression circuitry (see *Typical Application Circuit*). The charge pump inverts the positive supply ( $V_{DD}$ ), creating a negative supply ( $V_{SS}$ ). The headphone drivers operate from these bipolar supplies with their outputs biased about GND (Figure 1). The drivers have almost twice the supply range compared to other 3V single-supply drivers, increasing the available output power. The benefit of this GND bias is that the driver outputs do not have a DC component typically  $V_{DD}/2$ . The large DC-blocking capacitors required with conventional headphone drivers are unnecessary, thus conserving board space, system cost, and improving frequency response.

Each channel has independent left/right, active-low shutdown controls, optimizing power savings in mixed-mode, mono/stereo operation. The device features an undervoltage lockout that prevents operation from an insufficient power supply and click-and-pop suppression that eliminates audible transients on startup and shutdown. Additionally, the MAX4411 features thermal-overload and short-circuit protection and can withstand  $\pm 8\text{kV}$  ESD strikes on the output pins.

### Fixed Gain

The MAX4411 utilizes an internally fixed gain configuration of either  $-1.5\text{V/V}$  (MAX4411) or  $-2\text{V/V}$  (MAX4411B). All gain-setting resistors are integrated into the device, reducing external component count. The internally set gain, in combination with DirectDrive, results in a headphone amplifier that requires only five tiny  $1\mu\text{F}$  capacitors to complete the amplifier circuit: two for the charge pump, two for audio input coupling, and one for power-supply bypassing (see *Typical Application Circuit*).

### DirectDrive

Conventional single-supply headphone drivers have their outputs biased about a nominal DC voltage (typically half the supply) for maximum dynamic range. Large coupling capacitors are needed to block this DC bias from the headphone. Without these capacitors, a significant amount of DC current flows to the headphone, resulting in unnecessary power dissipation and possible damage to both headphone and headphone driver.

Maxim's patented DirectDrive architecture uses a charge pump to create an internal negative supply volt-

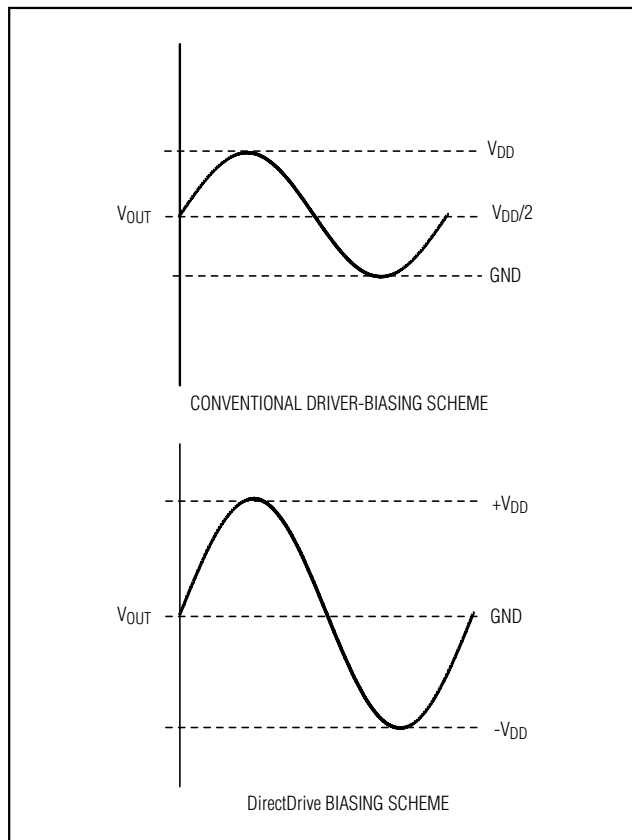

Figure 1. Conventional Driver Output Waveform vs. MAX4411 Output Waveform

age. This allows the MAX4411 outputs to be biased about GND, almost doubling dynamic range while operating from a single supply. With no DC component, there is no need for the large DC-blocking capacitors. Instead of two large ( $220\mu\text{F}$ , typ) tantalum capacitors, the MAX4411 charge pump requires two small ceramic capacitors, conserving board space, reducing cost, and improving the frequency response of the headphone driver. See the Output Power vs. Charge-Pump Capacitance and Load Resistance graph in the *Typical Operating Characteristics* for details of the possible capacitor sizes. There is a low DC voltage on the driver outputs due to amplifier offset. However, the offset of the MAX4411 is typically  $0.7\text{mV}$ , which, when combined with a  $32\Omega$  load, results in less than  $23\mu\text{A}$  of DC current flow to the headphones.

Previous attempts to eliminate the output-coupling capacitors involved biasing the headphone return (sleeve) to the DC-bias voltage of the headphone amplifiers. This

# 80mW, Fixed-Gain, DirectDrive, Stereo Headphone Amplifier with Shutdown

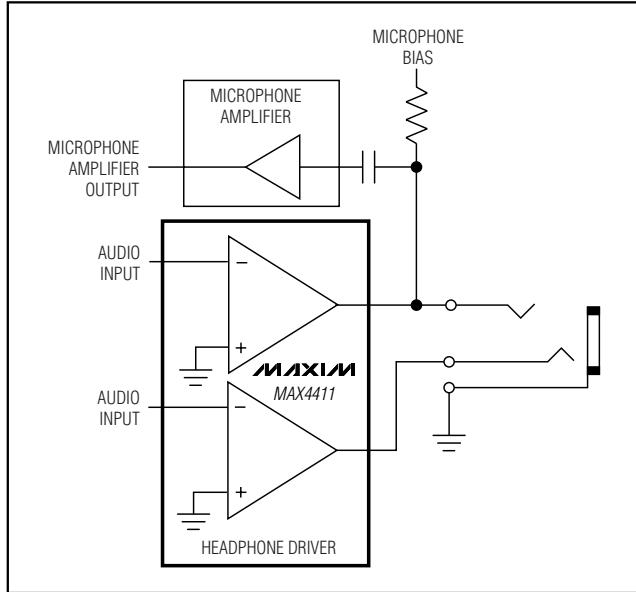

Figure 2. Earbud Speaker/Microphone Combination Headset Configuration

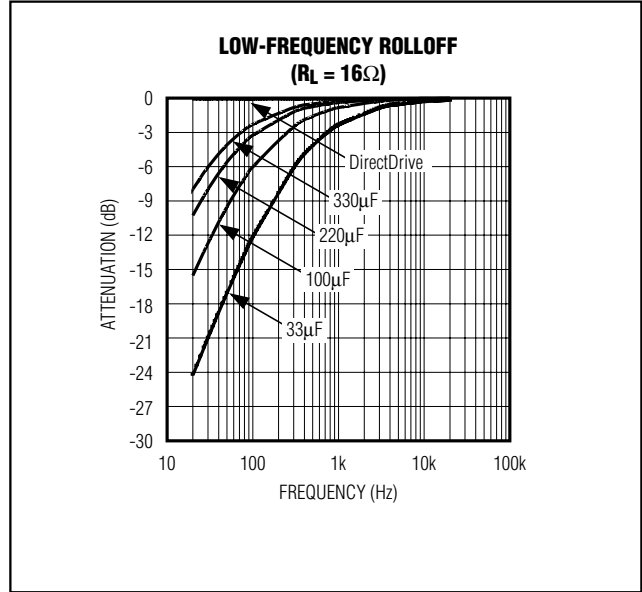

Figure 3. Low-Frequency Attenuation for Common DC-Blocking Capacitor Values

method raises some issues:

- The sleeve is typically grounded to the chassis. Using this biasing approach, the sleeve must be isolated from system ground, complicating product design.
- During an ESD strike, the driver's ESD structures are the only path to system ground. Thus, the driver must be able to withstand the full ESD strike.
- When using the headphone jack as a line out to other equipment, the bias voltage on the sleeve may conflict with the ground potential from other equipment, resulting in possible damage to the drivers.
- When using a combination microphone and speaker headset, the microphone typically requires a GND reference. The driver DC bias on the sleeve conflicts with the microphone requirements (Figure 2).

### Low-Frequency Response

In addition to the cost and size disadvantages of the DC-blocking capacitors required by conventional headphone amplifiers, these capacitors limit the amplifier's low-frequency response and can distort the audio signal:

- 1) The impedance of the headphone load and the DC-blocking capacitor forms a highpass filter with the -3dB point set by:

$$f_{-3dB} = \frac{1}{2\pi R_L C_{OUT}}$$

where  $R_L$  is the impedance of the headphone and  $C_{OUT}$  is the value of the DC-blocking capacitor.

The highpass filter is required by conventional single-ended, single power-supply headphone drivers to block the midrail DC-bias component of the audio signal from the headphones. The drawback to the filter is that it can attenuate low-frequency signals. Larger values of  $C_{OUT}$  reduce this effect but result in physically larger, more expensive capacitors. Figure 3 shows the relationship between the size of  $C_{OUT}$  and the resulting low-frequency attenuation. Note that the -3dB point for a  $16\Omega$  headphone with a  $100\mu F$  blocking capacitor is 100Hz, well within the normal audio band, resulting in low-frequency attenuation of the reproduced signal.

- 2) The voltage coefficient of the DC-blocking capacitor contributes distortion to the reproduced audio signal as the capacitance value varies as the function of the voltage across the capacitor changes. At low frequencies, the reactance of the capacitor dominates at frequencies below the -3dB point and the voltage coefficient appears as frequency-dependent distortion. Figure 4 shows the THD+N intro-

# 80mW, Fixed-Gain, DirectDrive, Stereo Headphone Amplifier with Shutdown

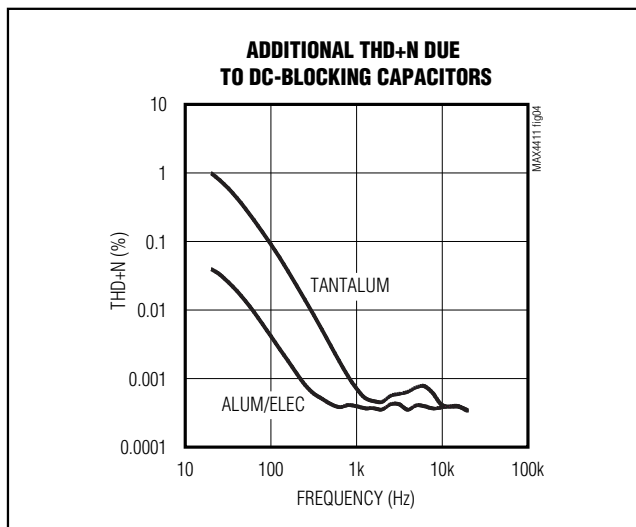

Figure 4. Distortion Contributed by DC-Blocking Capacitors

duced by two different capacitor dielectric types. Note that below 100Hz, THD+N increases rapidly.

The combination of low-frequency attenuation and frequency-dependent distortion compromises audio reproduction in portable audio equipment that emphasizes low-frequency effects such as multimedia laptops, as well as MP3, CD, and DVD players. By eliminating the DC-blocking capacitors through DirectDrive technology, these capacitor-related deficiencies are eliminated.

### Charge Pump

The MAX4411 features a low-noise charge pump. The 320kHz switching frequency is well beyond the audio range, and thus does not interfere with the audio signals. The switch drivers feature a controlled switching speed that minimizes noise generated by turn-on and turn-off transients. By limiting the switching speed of the charge pump, the di/dt noise caused by the parasitic bond wire and trace inductance is minimized. Although not typically required, additional high-frequency noise attenuation can be achieved by increasing the size of C2 (see *Typical Application Circuit*).

### Shutdown

The MAX4411 features two shutdown controls allowing either channel to be shut down or muted independently.  $\overline{\text{SHDNL}}$  controls the left channel while  $\overline{\text{SHDNR}}$  controls the right channel. Driving either  $\overline{\text{SHDN}}$  low disables the respective channel, sets the driver output impedance to 1k $\Omega$ , and reduces the supply current. When both  $\overline{\text{SHDN}}$  inputs are driven low, the charge pump is also disabled, further reducing supply current draw to

6 $\mu$ A. The charge pump is enabled once either  $\overline{\text{SHDN}}$  input is driven high.

### Click-and-Pop Suppression

In conventional single-supply audio drivers, the output-coupling capacitor is a major contributor of audible clicks and pops. Upon startup, the driver charges the coupling capacitor to its bias voltage, typically half the supply. Likewise, on shutdown, the capacitor is discharged to GND. This results in a DC shift across the capacitor, which in turn, appears as an audible transient at the speaker. Since the MAX4411 does not require output-coupling capacitors, this does not arise.

Additionally, the MAX4411 features extensive click-and-pop suppression that eliminates any audible transient sources internal to the device. The Power-Up/Down Waveform in the *Typical Operating Characteristics* shows that there are minimal spectral components in the audible range at the output upon startup or shutdown.

In most applications, the output of the preamplifier driving the MAX4411 has a DC bias of typically half the supply. At startup, the input-coupling capacitor is charged to the preamplifier's DC-bias voltage through the  $R_{\text{F}}$  of the MAX4411, resulting in a DC shift across the capacitor and an audible click/pop. Delaying the rise of the  $\overline{\text{SHDN}}$  signals 4 to 5 time constants (80ms to 100ms) based on  $R_{\text{IN}}$  and  $C_{\text{IN}}$ , relative to the startup of the preamplifier, eliminates this click/pop caused by the input filter.

## Applications Information

### Power Dissipation

Under normal operating conditions, linear power amplifiers can dissipate a significant amount of power. The maximum power dissipation for each package is given in the *Absolute Maximum Ratings* section under Continuous Power Dissipation or can be calculated by the following equation:

$$P_{\text{DISSPKG(MAX)}} = \frac{T_{\text{J(MAX)}} - T_{\text{A}}}{\theta_{\text{JA}}}$$

where  $T_{\text{J(MAX)}}$  is +150°C,  $T_{\text{A}}$  is the ambient temperature, and  $\theta_{\text{JA}}$  is the reciprocal of the derating factor in °C/W as specified in the *Absolute Maximum Ratings* section. For example,  $\theta_{\text{JA}}$  of the QFN package is +59.3°C/W.

The MAX4411 has two power dissipation sources, the charge pump and the two drivers. If the power dissipation for a given application exceeds the maximum allowed for a given package, either reduce  $V_{\text{DD}}$ , increase load impedance, decrease the ambient temperature, or add heatsinking to the device. Large

# 80mW, Fixed-Gain, DirectDrive, Stereo Headphone Amplifier with Shutdown

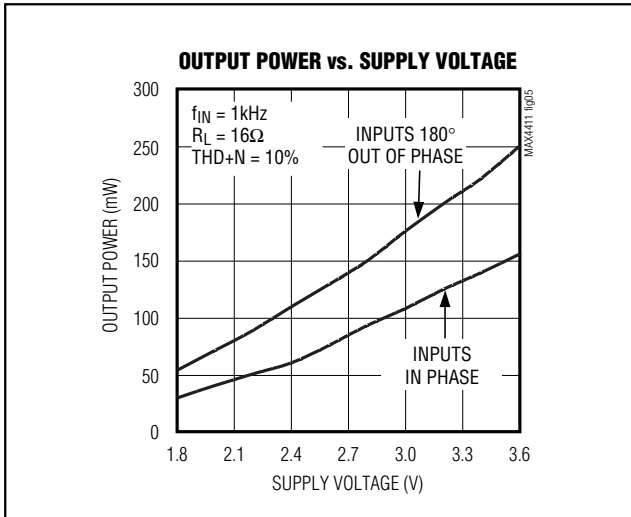

Figure 5. Output Power vs. Supply Voltage with Inputs In/Out of Phase

output, supply, and ground traces improve the maximum power dissipation in the package.

Thermal-overload protection limits total power dissipation in the MAX4411. When the junction temperature exceeds +140°C, the thermal protection circuitry disables the amplifier output stage. The amplifiers are enabled once the junction temperature cools by 15°C. This results in a pulsing output under continuous thermal-overload conditions.

### Output Power

The device has been specified for the worst-case scenario—when both inputs are in phase. Under this condition, the drivers simultaneously draw current from the charge pump, leading to a slight loss in headroom of V<sub>SS</sub>. In typical stereo audio applications, the left and right signals have differences in both magnitude and phase, subsequently leading to an increase in the maximum attainable output power. Figure 5 shows the two extreme cases for in and out of phase. In reality, the available power lies between these extremes.

### Powering Other Circuits from a Negative Supply

An additional benefit of the MAX4411 is the internally generated, negative supply voltage (PV<sub>SS</sub>). This voltage provides the ground-referenced output level. PV<sub>SS</sub> can, however, also be used to power other devices within a design limit current drawn from PV<sub>SS</sub> to 5mA; exceeding this affects the headphone driver operation. A typical application is a negative supply to adjust the contrast of LCD modules.

PV<sub>SS</sub> is roughly proportional to PV<sub>DD</sub> and is not a regulated voltage. The charge-pump output impedance must be taken into account when powering other devices from PV<sub>SS</sub>. The charge-pump output impedance plot appears in the *Typical Operating Characteristics*. For best results, use 2.2μF charge-pump capacitors.

### Component Selection

#### Input Filtering

The input capacitor (C<sub>IN</sub>), in conjunction with the internal R<sub>IN</sub>, forms a highpass filter that removes the DC bias from an incoming signal (see *Typical Application Circuit*). The AC-coupling capacitor allows the amplifier to bias the signal to an optimum DC level. Assuming zero-source impedance, the -3dB point of the highpass filter is given by:

$$f_{-3dB} = \frac{1}{2\pi R_{IN} C_{IN}}$$

R<sub>IN</sub> is the amplifier's internal input resistance value given in the *Electrical Characteristics*. Choose the C<sub>IN</sub> such that f<sub>-3dB</sub> is well below the lowest frequency of interest. Setting f<sub>-3dB</sub> too high affects the amplifier's low-frequency response. Use capacitors whose dielectrics have low-voltage coefficients, such as tantalum or aluminum electrolytic ones. Capacitors with high-voltage coefficients, such as ceramics, may result in increased distortion at low frequencies.

#### Charge-Pump Capacitor Selection

Use capacitors with an ESR less than 100mΩ for optimum performance. Low-ESR ceramic capacitors minimize the output resistance of the charge pump. For best performance over the extended temperature range, select capacitors with an X7R dielectric. Table 1 lists suggested manufacturers.

#### Flying Capacitor (C1)

The value of the flying capacitor (C1) affects the charge pump's load regulation and output resistance. A C1 value that is too small degrades the device's ability to provide sufficient current drive, which leads to a loss of output voltage. Increasing the value of C1 improves load regulation and reduces the charge-pump output resistance to an extent. See the Output Power vs. Charge-Pump Capacitance and Load Resistance graph in the *Typical Operating Characteristics*. Above 2.2μF, the on-resistance of the switches and the ESR of C1 and C2 dominate.

#### Hold Capacitor (C2)

The hold capacitor value and ESR directly affect the ripple at PV<sub>SS</sub>. Increasing the value of C2 reduces

# 80mW, Fixed-Gain, DirectDrive, Stereo Headphone Amplifier with Shutdown

**Table 1. Suggested Capacitor Manufacturers**

SUPPLIER	PHONE	FAX	WEBSITE
Taiyo Yuden	800-348-2496	847-925-0899	www.t-yuden.com
TDK	847-803-6100	847-390-4405	www.component.tdk.com

**Note:** Please indicate you are using the MAX4411 when contacting these component suppliers.

output ripple. Likewise, decreasing the ESR of C2 reduces both ripple and output resistance. Lower capacitance values can be used in systems with low maximum output power levels. See the Output Power vs. Charge-Pump Capacitance and Load Resistance graph in the *Typical Operating Characteristics*.

### Power-Supply Bypass Capacitor

The power-supply bypass capacitor (C3) lowers the output impedance of the power supply, and reduces the impact of the MAX4411's charge-pump switching transients. Bypass PVDD with C3, the same value as C1, and place it physically close to the PVDD and PGND pins.

### Adding Volume Control

The addition of a digital potentiometer provides simple volume control. Figure 6 shows the MAX4411 with the MAX5408 dual log taper digital potentiometer used as an input attenuator. Connect the high terminal of the MAX5408 to the audio input, the low terminal to ground, and the wiper to CIN. Setting the wiper to the top position passes the audio signal unattenuated. Setting the wiper to the lowest position fully attenuates the input.

### Layout and Grounding

Proper layout and grounding are essential for optimum performance. Connect PGND and SGND together at a single point on the PC board. Connect all components associated with the charge pump (C2 and C3) to the PGND plane. Connect PVDD and SVDD together at the

device. Connect PVSS and SVSS together at the device. Bypassing of both supplies is accomplished by charge-pump capacitors C2 and C3 (see *Typical Application Circuit*). Place capacitors C2 and C3 as close to the device as possible. Route PGND and all traces that carry switching transients away from SGND and the traces and components in the audio signal path.

The QFN package features an exposed paddle that improves thermal efficiency of the package. However, the MAX4411 does not require additional heatsinking. **Ensure that the exposed paddle is isolated from GND or VDD. Do not connect the exposed paddle to GND or VDD.**

When using the MAX4411 in a UCSP package, make sure the traces to OUTR (bump C2) are wide enough to handle the maximum expected current flow. Multiple traces may be necessary.

### UCSP Applications Information

For the latest application details on UCSP construction, dimensions, tape carrier information, printed circuit board techniques, bump-pad layout, and recommended reflow temperature profile, as well as the latest information on reliability testing results, go to Maxim's website at [www.maxim-ic.com/ucsp](http://www.maxim-ic.com/ucsp) and look up the Application Note: *UCSP-A Wafer-Level Chip-Scale Package*.

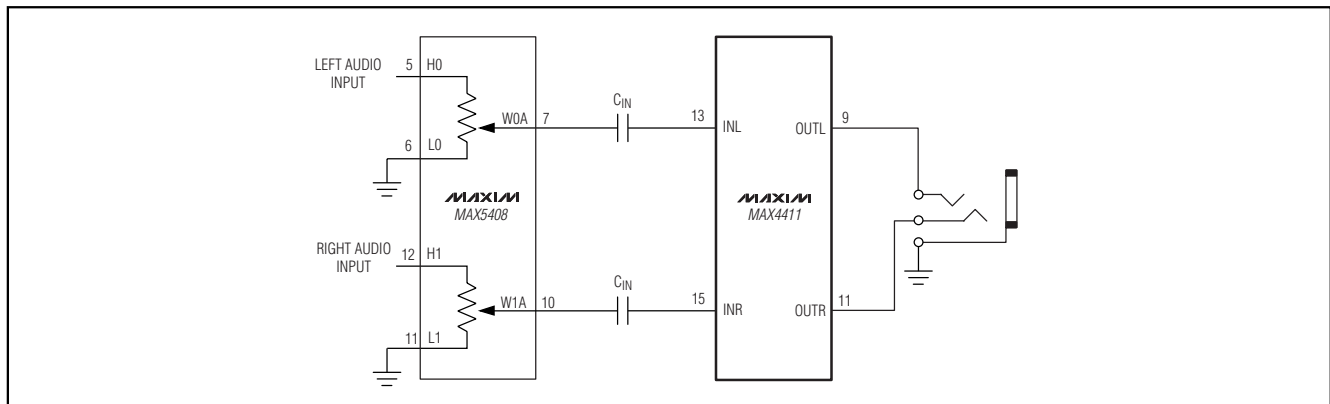
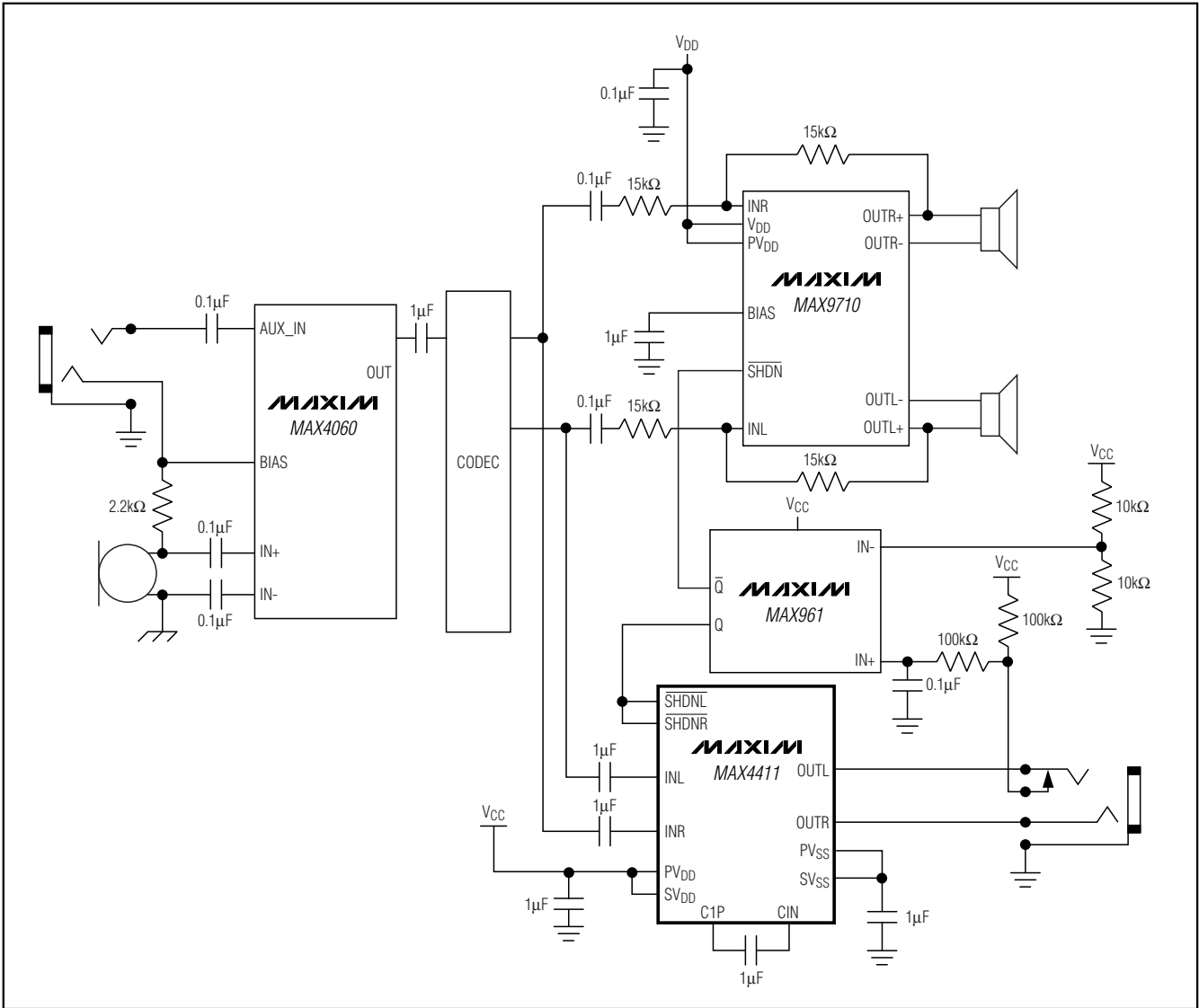

Figure 6. MAX4411 and MAX5408 Volume Control Circuit

# 80mW, Fixed-Gain, DirectDrive, Stereo Headphone Amplifier with Shutdown

System Diagram



# 80mW, Fixed-Gain, DirectDrive, Stereo Headphone Amplifier with Shutdown

## Typical Application Circuit

MAX4411

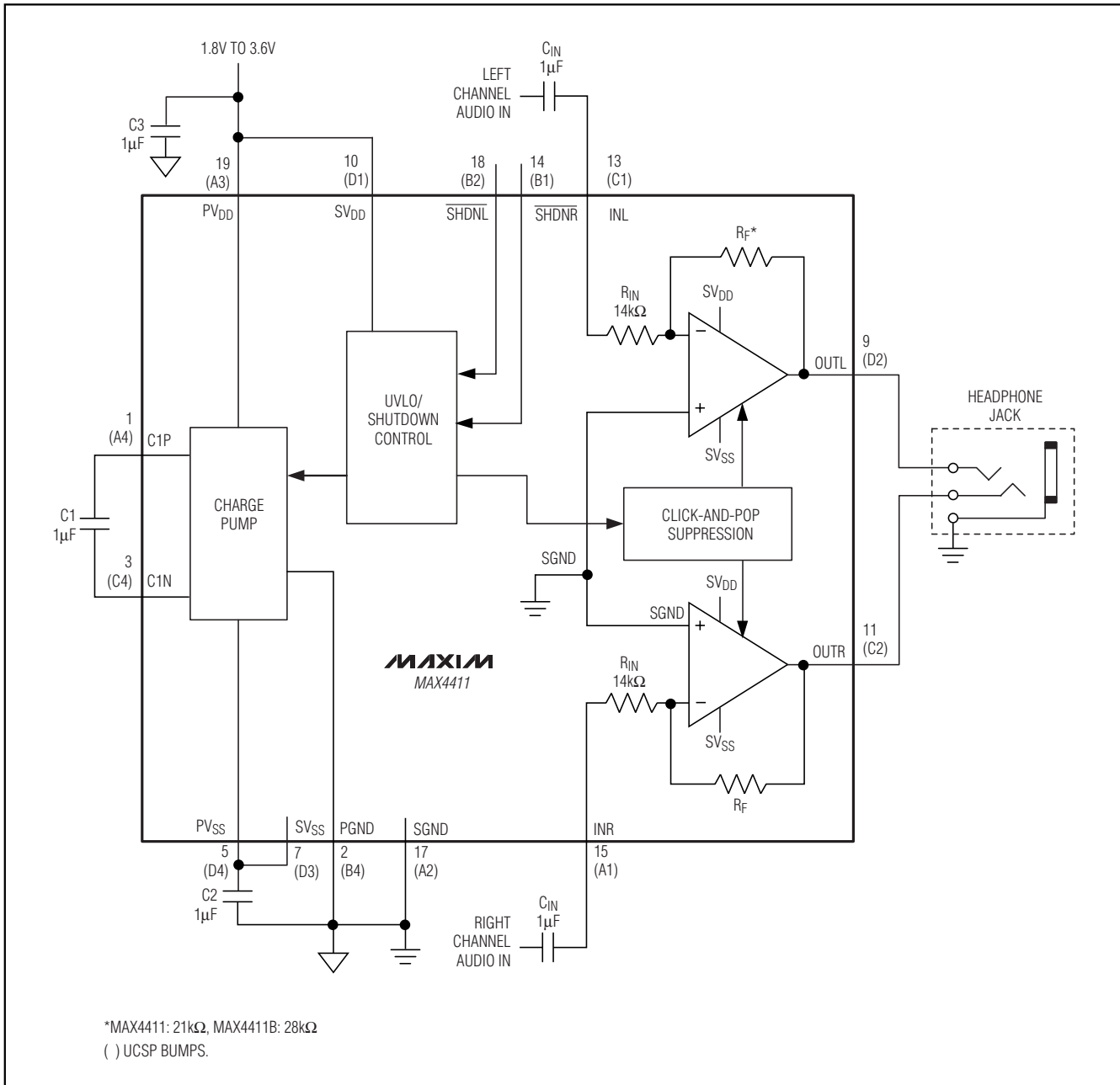

# 80mW, Fixed-Gain, DirectDrive, Stereo Headphone Amplifier with Shutdown

## Pin Configurations

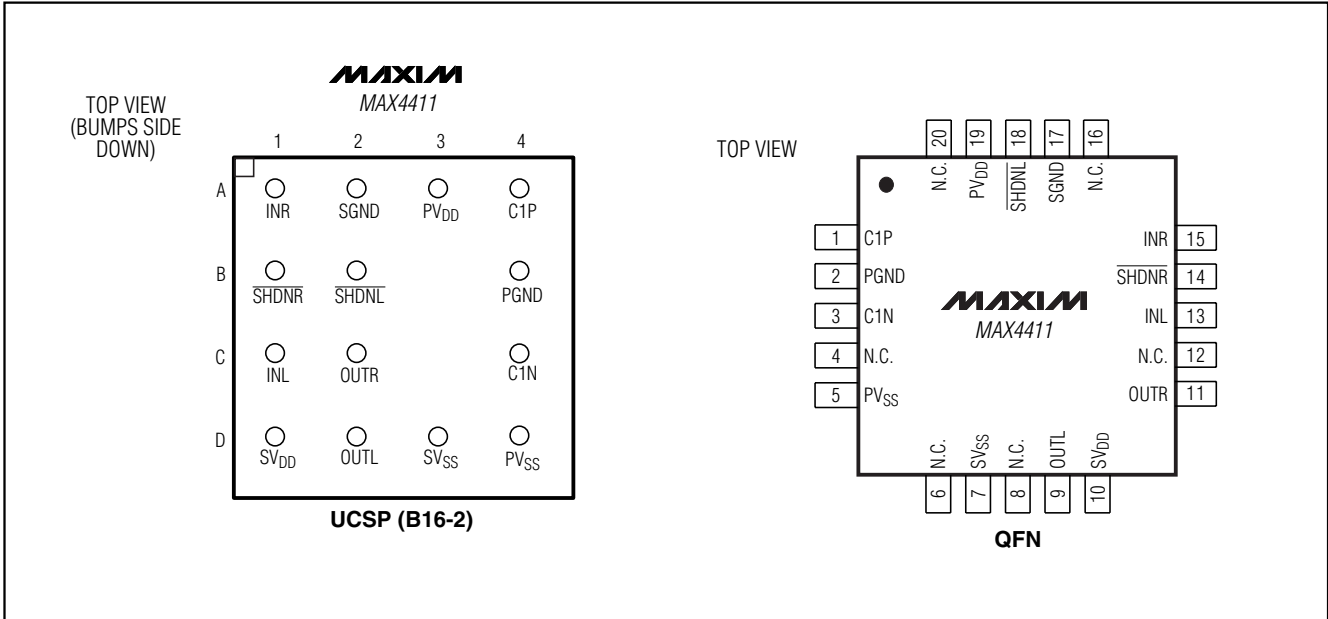

## Chip Information

TRANSISTOR COUNT: 4295

PROCESS: BiCMOS



# 80mW, Fixed-Gain, DirectDrive, Stereo Headphone Amplifier with Shutdown

## Package Information

(The package drawing(s) in this data sheet may not reflect the most current specifications. For the latest package outline information, go to [www.maxim-ic.com/packages](http://www.maxim-ic.com/packages).)

MAX4411

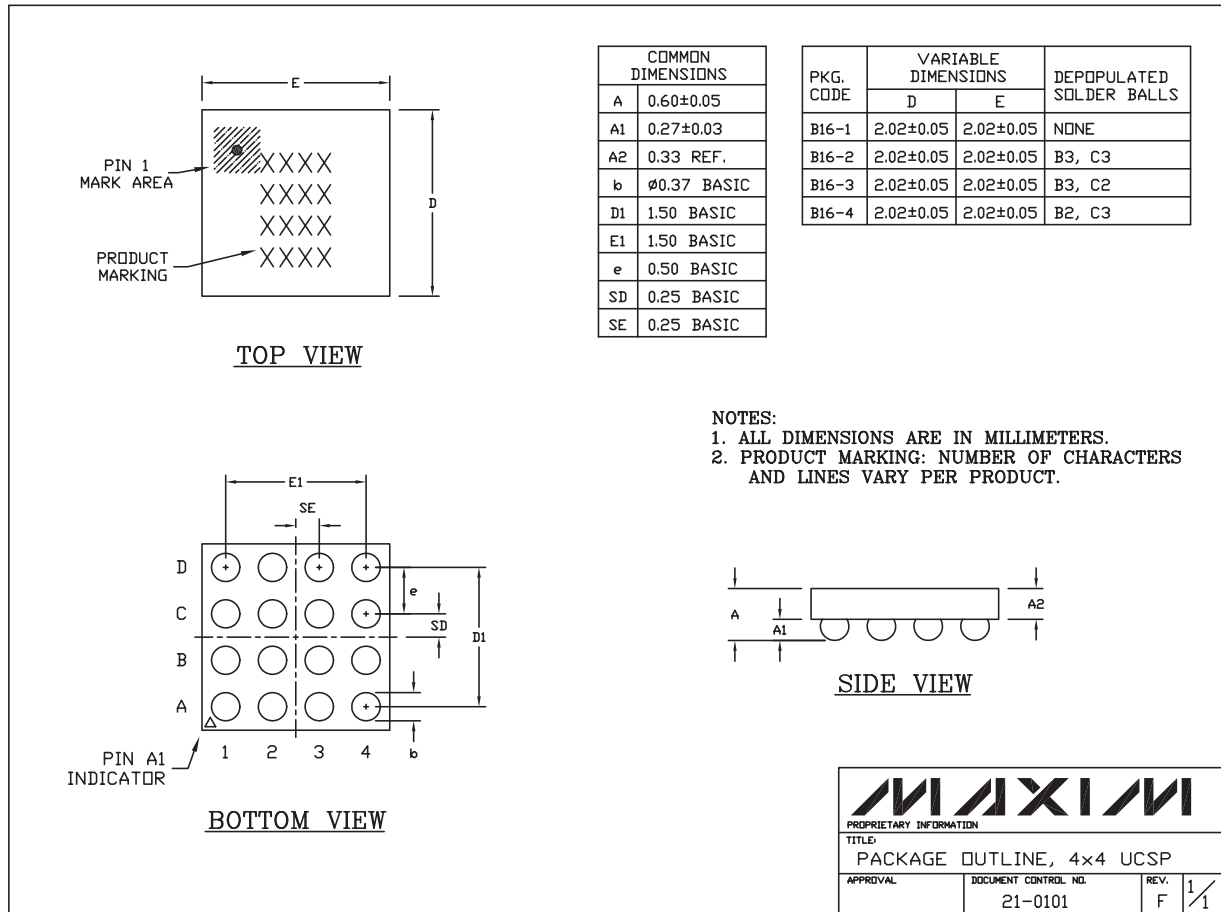

16L UCSP:EPS

# 80mW, Fixed-Gain, DirectDrive, Stereo Headphone Amplifier with Shutdown

## Package Information (continued)

(The package drawing(s) in this data sheet may not reflect the most current specifications. For the latest package outline information, go to [www.maxim-ic.com/packages](http://www.maxim-ic.com/packages).)

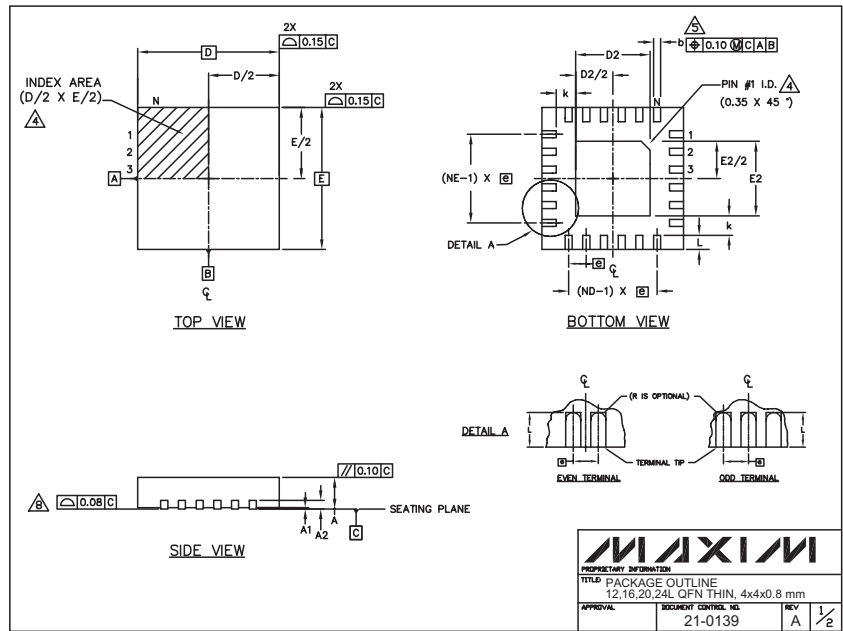

COMMON DIMENSIONS													EXPOSED PAD VARIATIONS							
PKG REF.	12L 4x4			16L 4x4			20L 4x4			24L 4x4			PKG CODES	D2			E2			
	MIN.	NDM.	MAX.	MIN.	NDM.	MAX.	MIN.	NDM.	MAX.	MIN.	NDM.	MAX.		MIN.	NDM.	MAX.	MIN.	NDM.	MAX.	
A	0.70	0.75	0.80	0.70	0.75	0.80	0.70	0.75	0.80	0.70	0.75	0.80	T1244-2	1.95	2.10	2.25	1.95	2.10	2.25	
A1	0.0	0.02	0.05	0.0	0.02	0.05	0.0	0.02	0.05	0.0	0.02	0.05	T1644-2	1.95	2.10	2.25	1.95	2.10	2.25	
A2	0.20 REF			0.20 REF			0.20 REF			0.20 REF			T2044-1	1.95	2.10	2.25	1.95	2.10	2.25	
b	0.25	0.30	0.35	0.25	0.30	0.35	0.20	0.25	0.30	0.18	0.23	0.30	T2444-1	2.45	2.60	2.63	2.45	2.60	2.63	
D	3.90	4.00	4.10	3.90	4.00	4.10	3.90	4.00	4.10	3.90	4.00	4.10								
E	3.90	4.00	4.10	3.90	4.00	4.10	3.90	4.00	4.10	3.90	4.00	4.10								
e	0.80 BSC.			0.65 BSC.			0.50 BSC.			0.50 BSC.										
k	0.25	-	-	0.25	-	-	0.25	-	-	0.25	-	-								
L	0.45	0.55	0.65	0.45	0.55	0.65	0.45	0.55	0.65	0.30	0.40	0.50								
N	12			16			20			24										
ND	3			4			5			6										
NE	3			4			5			6										
JeDEC Var.	WGGB			WGGC			WGGD-1			WGGD-2										

**NOTES:**

- DIMENSIONING & TOLERANCING CONFORM TO ASME Y14.5M-1994.
- ALL DIMENSIONS ARE IN MILLIMETERS. ANGLES ARE IN DEGREES.
- N IS THE TOTAL NUMBER OF TERMINALS.
- THE TERMINAL #1 IDENTIFIER AND TERMINAL NUMBERING CONVENTION SHALL CONFORM TO JEDEC 95-1 SPP-012. DETAILS OF TERMINAL #1 IDENTIFIER ARE OPTIONAL, BUT MUST BE LOCATED WITHIN THE ZONE INDICATED. THE TERMINAL #1 IDENTIFIER MAY BE EITHER A MOLD OR MARKED FEATURE.
- DIMENSION b APPLIES TO METALLIZED TERMINAL AND IS MEASURED BETWEEN 0.25 mm AND 0.30 mm FROM TERMINAL TIP.
- ND AND NE REFER TO THE NUMBER OF TERMINALS ON EACH D AND E SIDE RESPECTIVELY.
- DEPOPULATION IS POSSIBLE IN A SYMMETRICAL FASHION.
- COPLANARITY APPLIES TO THE EXPOSED HEAT SINK SLUG AS WELL AS THE TERMINALS.
- DRAWING CONFORMS TO JEDEC MO220.

Maxim cannot assume responsibility for use of any circuitry other than circuitry entirely embodied in a Maxim product. No circuit patent licenses are implied. Maxim reserves the right to change the circuitry and specifications without notice at any time.

18 **Maxim Integrated Products, 120 San Gabriel Drive, Sunnyvale, CA 94086 408-737-7600**