

**LA2110****FM Noise Canceller****Overview**

The LA2110 has the capability to effectively remove external noise (pulse noise) caused by engine, etc. and is used in conjunction with a PLL FM multiplex stereo demodulator (such as LA3375) with pilot signal canceller.

**Features**

- Pilot signal compensation function.
- By using in conjunction with PLL FM multiplex stereo demodulator with pilot signal canceller, adverse effect caused by pilot signal can be compensated.
- Low distortion factor : THD=0.02%, 300mV.
- Good space facator due to single end package.
- Variable input type noise AGC system. This system widens the noise detector's dynamic range, so that pulse noise can be satisfactorily detected even in a weak electric field, and pulse noise is removed without adversely affecting distortion factor.

**Package Dimensions**

unit:mm

3193-SIP16Z

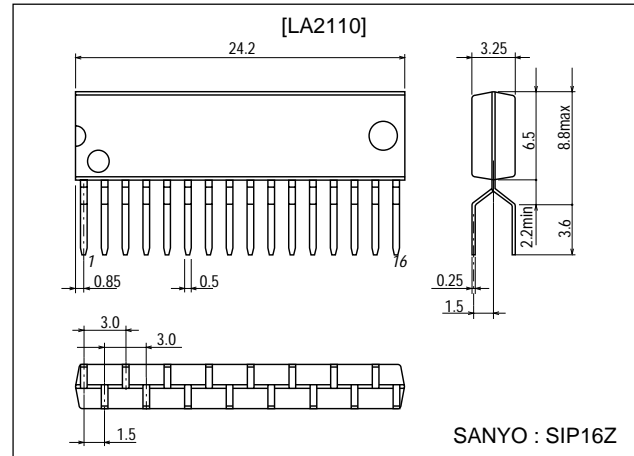
**Specifications****Absolute Maximum Ratings** at  $T_a = 25^\circ\text{C}$ 

Parameter	Symbol	Conditions	Ratings	Unit
Maximum Supply Voltage	$V_{CC \text{ max}}$		16	V
Allowable Power Dissipation	$P_d \text{ max}$	$T_a \leq 50^\circ\text{C}$	450	mW
Operating Temperature	$T_{opr}$		-20 to +75	$^\circ\text{C}$
Storage Temperature	$T_{stg}$		-40 to +125	$^\circ\text{C}$

**Recommended Operating Conditions** at  $T_a = 25^\circ\text{C}$ 

Parameter	Symbol	Conditions	Ratings	Unit
Recommended Supply Voltage	$V_{CC}$		12	V
Operating Voltage Range	$V_{CC \text{ op}}$		8 to 15	V

■ Any and all SANYO products described or contained herein do not have specifications that can handle applications that require extremely high levels of reliability, such as life-support systems, aircraft's control systems, or other applications whose failure can be reasonably expected to result in serious physical and/or material damage. Consult with your SANYO representative nearest you before using any SANYO products described or contained herein in such applications.

■ SANYO assumes no responsibility for equipment failures that result from using products at values that exceed, even momentarily, rated values (such as maximum ratings, operating condition ranges, or other parameters) listed in products specifications of any and all SANYO products described or contained herein.

**SANYO Electric Co.,Ltd. Semiconductor Company**

TOKYO OFFICE Tokyo Bldg., 1-10, 1 Chome, Ueno, Taito-ku, TOKYO, 110-8534 JAPAN

# LA2110

**Operating Conditions** at  $T_a = 25^\circ\text{C}$ ,  $V_{CC}=12\text{V}$ , See specified Test Circuit

Parameter	Symbol	Conditions		Ratings			Unit
		(input pin)	(output pin)	min	typ	max	
Quiescent Current	$I_{CCO}$				16	25	mA
Voltage Gain	VG	$V_7=300\text{mV}$ , $f=1\text{kHz}$	Output	-0.2	+0.8	+1.8	dB
Input Signal Dynamic Range	$V_D$	$V_7$ , $f=1\text{kHz}$	Output, THD=1%	1.3			V
Input Impedance	$Z_{in}$	$V_7=300\text{mV}$ , $f=1\text{kHz}$		36k	51k	67k	$\Omega$
Total Harmonic Distortion	THD	$V_7=300\text{mV}$ , $f=1\text{kHz}$	Output		0.01	0.03	%
Low-pass Amp Gain	$V_{GL}$	$V_5=300\text{mV}$ , $f=1\text{kHz}$	$V_4$	1.0	1.1	1.2	times
High-pass Amp Gain	$V_{GH}$	$V_9=100\text{mV}$ , $f=200\text{kHz}$	$V_{10}$	1.2	1.4	1.65	times
Inverting Amp Distortion Factor	THD <sub>I</sub>	$V_{15}=100\text{mV}$ , $f=19\text{kHz}$	Output			0.1	%
Inverting Amp Dynamic Range	$V_{DI}$	$V_{15}$ , $f=19\text{kHz}$	Output, THD=1%	300			mV
Inverting Amp Gain	$V_{GI}$	$V_{15}=100\text{mV}$ , $f=19\text{kHz}$	Output	1.0	1.3	1.6	times
Output Noise Voltage	$V_{NO}$	$V_7, V_{15}$ shorted to GND	Output, 100kHz low-pass filter		30	60	$\mu\text{V}$
Gate Time	$t_{gate}$	$V_7=100\text{mVp-p}$ , $1\mu\text{s}$ , $f=1\text{kHz}$	Output	13	21	30	$\mu\text{s}$
Noise Sensitivity	$S_N$	$V_7$ , $1\mu\text{s}$ , $f=1\text{kHz}$	Output			30	mVp-o

## Test Circuit

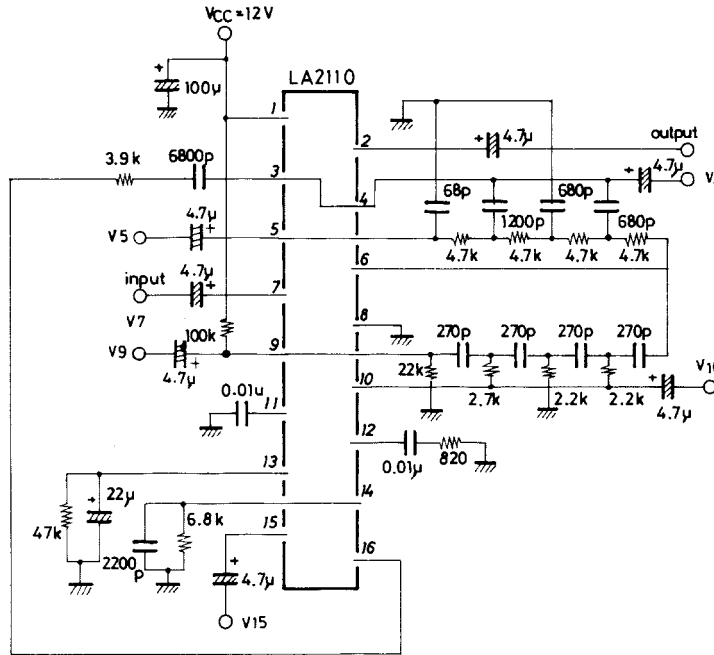

Unit (resistance:  $\Omega$ , capacitance: F)

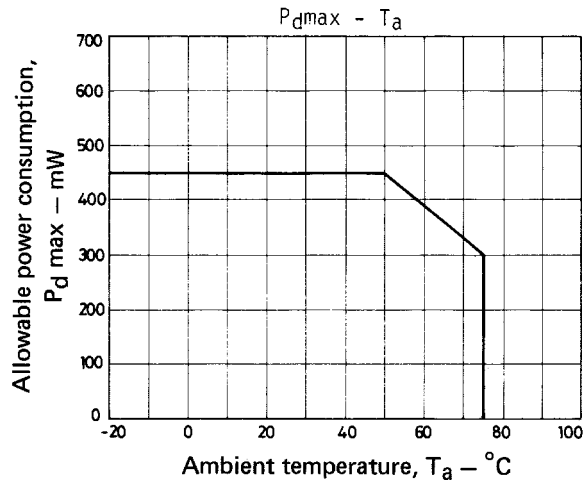

Equivalent Circuit Block Diagram

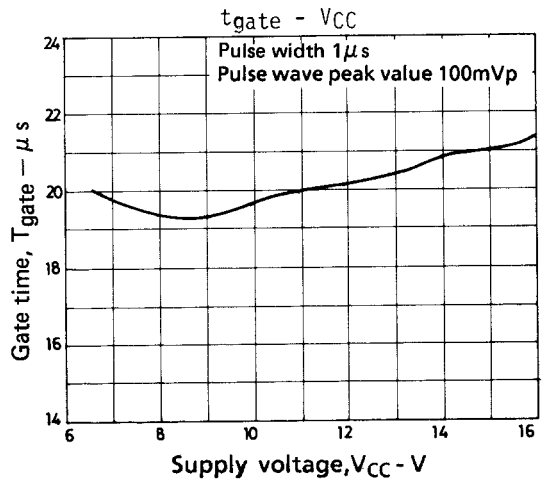
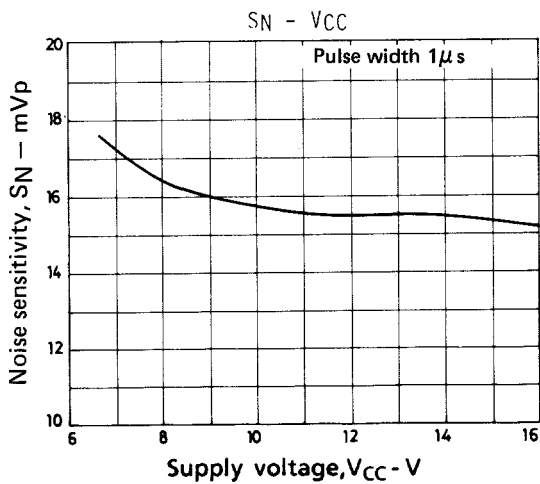
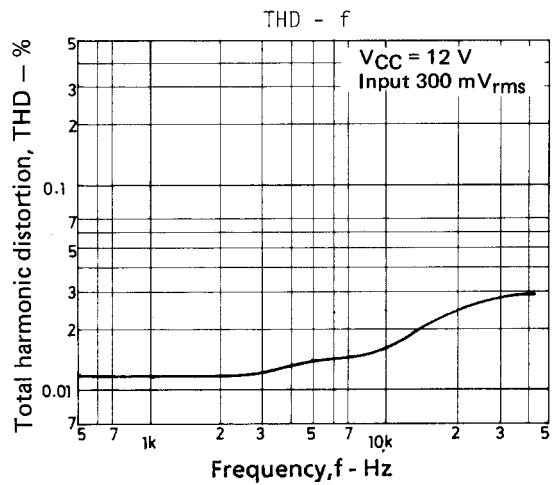
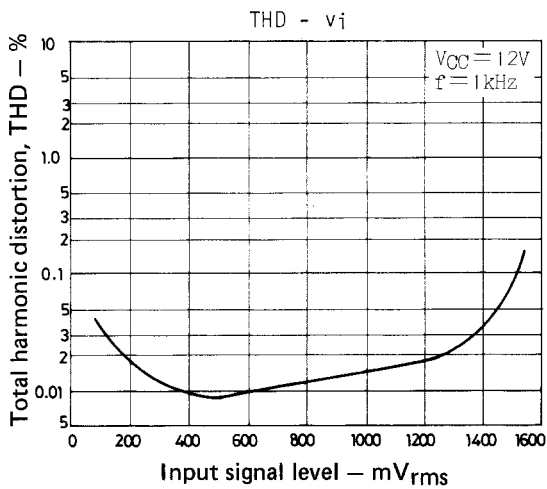
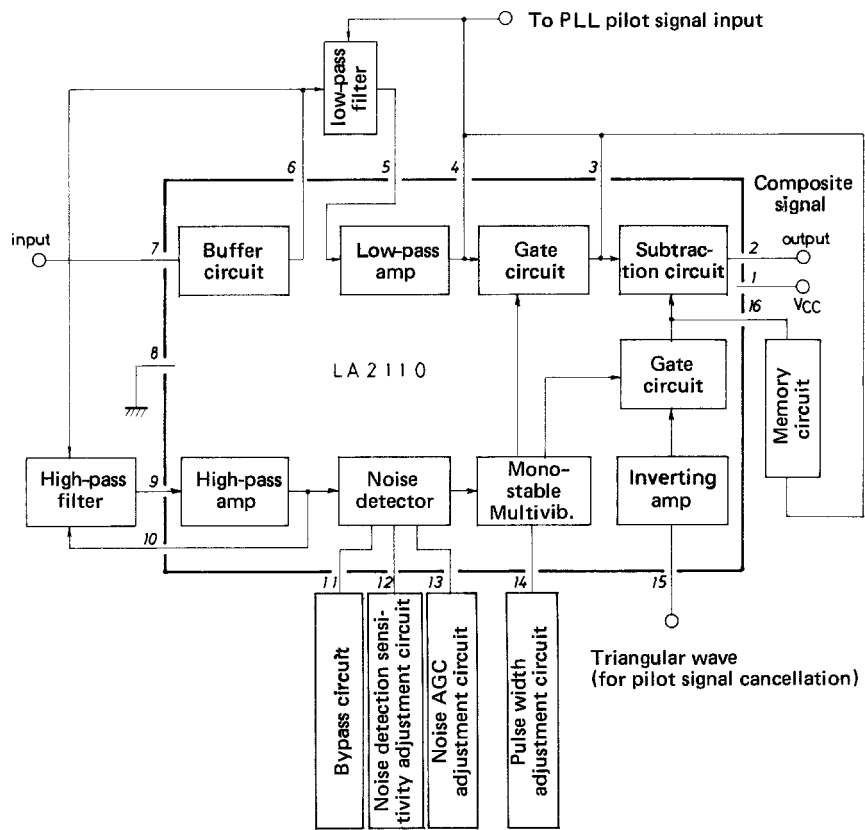

# LA2110

[Theory of LA2110 Noise Canceller]

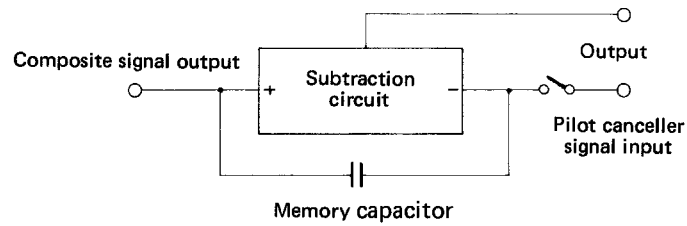

In order to simplify the operation theory, the composite signal component is given only as a low frequency signal and a pilot cancel signal has the same phase, same amplitude as the pilot signal in the composite signal.

Since the output voltage is the differential voltage of the plus and minus input of the subtraction circuit, it is equal to the voltage between the memory capacitor terminals. When the gate is closed, the composite signal is applied to the plus input terminal of the subtraction circuit, and the pilot cancel signal is applied to the minus input terminal. Thus the pilot signal is cancelled from the output and only the low frequency signal appears. In the same way, the voltage between the memory capacitor terminals is the differential voltage of the composite signal and the pilot cancel signal, so only the low frequency signal appears.

When pulse noise is generated and the gate opens, the plus input and minus input signal waveforms of the subtraction circuit become equal. This is because the input impedance of the subtraction circuit is extremely high, so the memory capacitor is considered AC-shorted. Thus, when pulse noise is generated in the composite signal, the same pulse noise appears in minus as well as plus input of the subtraction circuit. As a result, pulse noise does not appear in the output. The voltage in the output has a DC level difference of plus and minus input, and that is the voltage held by the memory capacitor. This voltage is that between the memory capacitor terminals just before the gate opens, so it is the low frequency signal voltage just before the gate opens. Because the subtraction circuit input impedance is high, no charge/discharge current flows in the memory capacitor while the gate is open, so the memory capacitor can hold the voltage between its terminals.

The voltage waveforms are illustrated below.

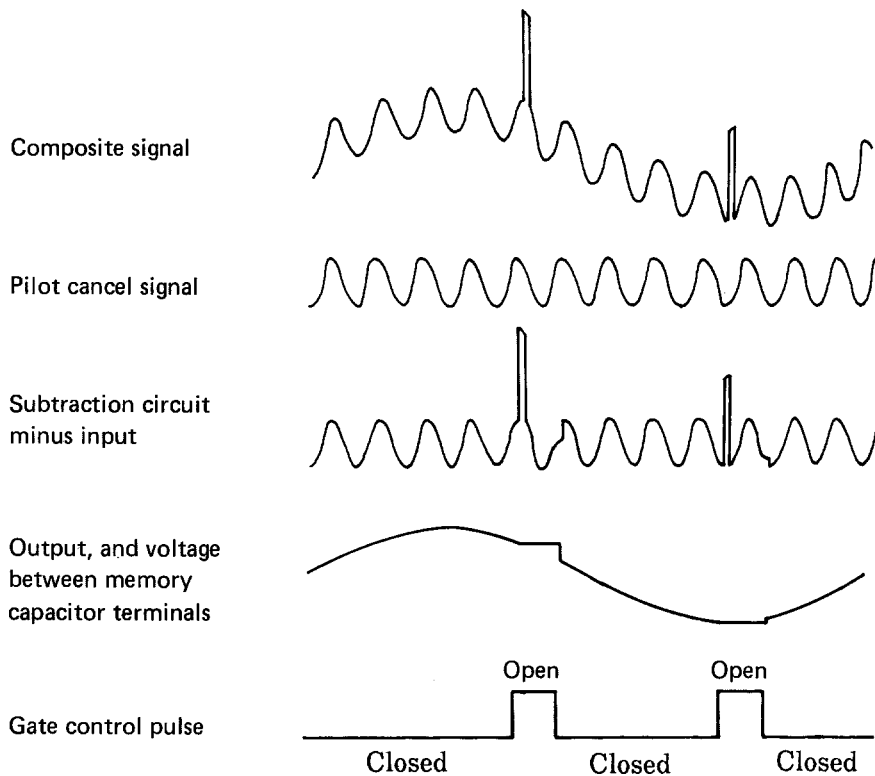

Note : The pilot cancel signal is given as sinusoidal in this explanation, but in the actual application circuit, pilot cancel is performed by a triangular wave.

# LA2110

## Sample Application Circuit : LA2110 & LA3375

Unit (resistance:  $\Omega$ , capacitance: F)

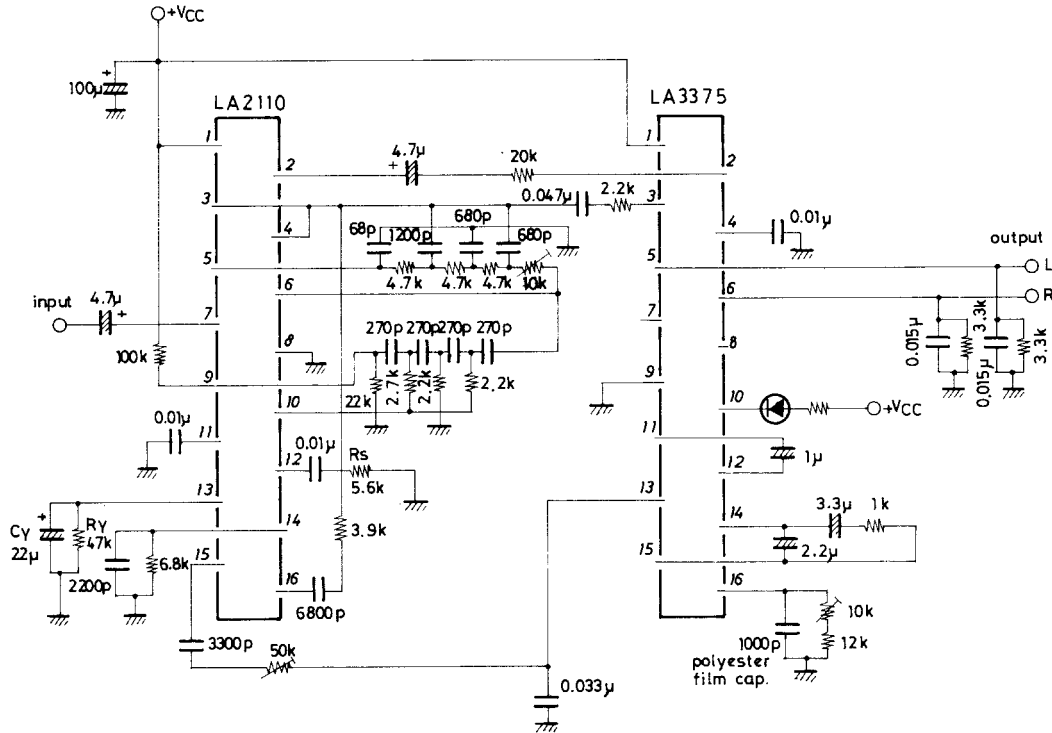

Note : When using the sample application circuit :

1. Separation adjustment is performed with 10k $\Omega$  variable resistance in low-pass filter.
2. Change noise detection sensitivity control  $R_S$  to an adequate value for strong or medium electric field.
3. Adjust noise AGC with CY, RY for effective noise suppression in a medium or weak electric field.
4. Adjust pilot cancel degree with variable resistance of 50k $\Omega$  connected to LA2110 pin 15.
5. By changing the 1 $\mu$ F capacitor between LA3375 pin 11 and 12, pilot cancel follow-up response time can be changed. But if the value is decreased, distortion factor, etc. will be adversely affected.

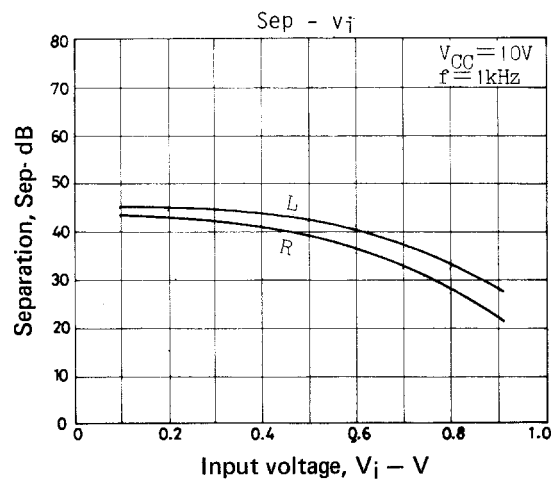
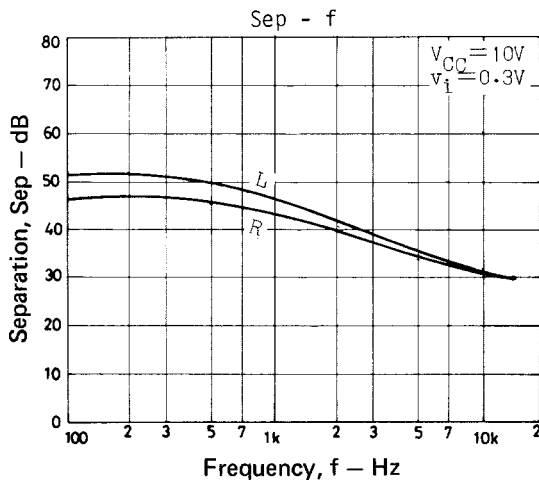

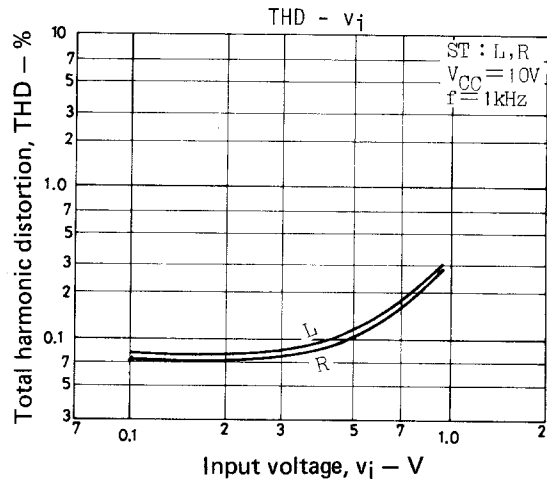
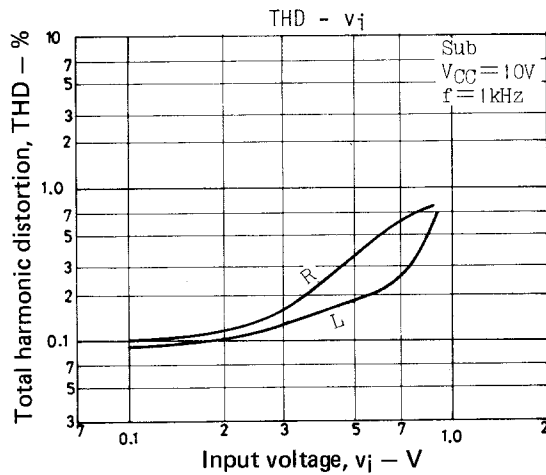
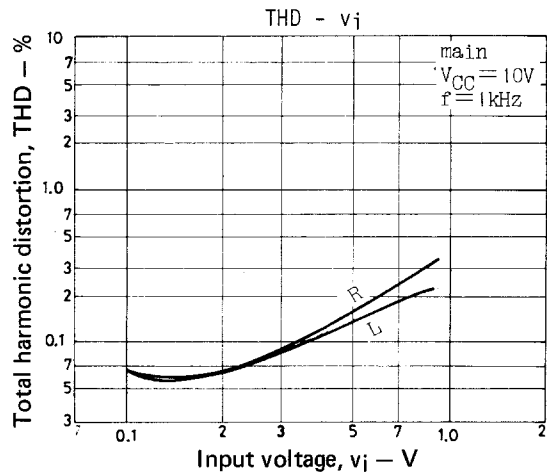
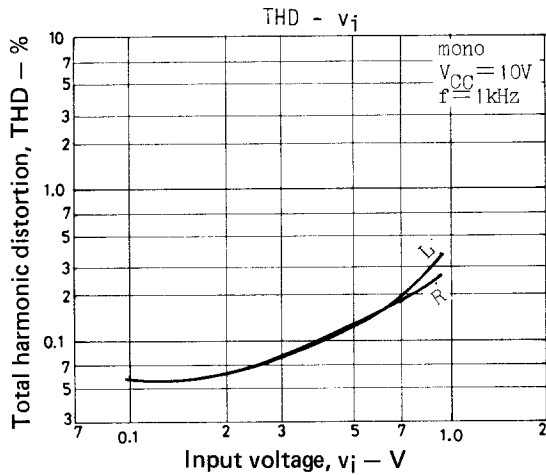

- Specifications of any and all SANYO products described or contained herein stipulate the performance, characteristics, and functions of the described products in the independent state, and are not guarantees of the performance, characteristics, and functions of the described products as mounted in the customer's products or equipment. To verify symptoms and states that cannot be evaluated in an independent device, the customer should always evaluate and test devices mounted in the customer's products or equipment.
- SANYO Electric Co., Ltd. strives to supply high-quality high-reliability products. However, any and all semiconductor products fail with some probability. It is possible that these probabilistic failures could give rise to accidents or events that could endanger human lives, that could give rise to smoke or fire, or that could cause damage to other property. When designing equipment, adopt safety measures so that these kinds of accidents or events cannot occur. Such measures include but are not limited to protective circuits and error prevention circuits for safe design, redundant design, and structural design.
- In the event that any or all SANYO products (including technical data, services) described or contained herein are controlled under any of applicable local export control laws and regulations, such products must not be exported without obtaining the export license from the authorities concerned in accordance with the above law.
- No part of this publication may be reproduced or transmitted in any form or by any means, electronic or mechanical, including photocopying and recording, or any information storage or retrieval system, or otherwise, without the prior written permission of SANYO Electric Co., Ltd.
- Any and all information described or contained herein are subject to change without notice due to product/technology improvement, etc. When designing equipment, refer to the "Delivery Specification" for the SANYO product that you intend to use.
- Information (including circuit diagrams and circuit parameters) herein is for example only; it is not guaranteed for volume production. SANYO believes information herein is accurate and reliable, but no guarantees are made or implied regarding its use or any infringements of intellectual property rights or other rights of third parties.

This catalog provides information as of January, 2000. Specifications and information herein are subject to change without notice.