

PWM TYPE 3-PHASE DC BRUSHLESS MOTOR CONTROL IC

■ GENERAL DESCRIPTION

The NJM2626 is a 3-phase DC brush less motor control pre-driver IC with PWM control.

It takes hall IC inputs and generates motor driving waveform.

Output pre-driver is optimized to work with external power MOS transistors for better power handling.

The NJM2626 can easily implement 3-phase DC motor application with speed control feature.

■ PACKAGE OUTLINE

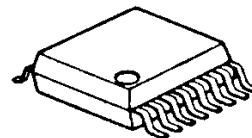

NJM2626V

■ FEATURES

- Operating Voltage 6 to 26V
- Pre-driver circuit
 - Lower arm : (Iout=+30mA/-30mA TYP.)
 - Upper arm : (Iout=30mA TYP.)
- Current limit sense voltage (Current limit=0.5V±10%)
- Internal Oscillator
 - (Frequency control for external capacitor)
- Forward or Reverse direction
- Internal Soft Start (External capacitor to Verr pin)
- Internal ON/OFF Circuit (No-output is Verr pin to GND)
- Bipolar Technology
- Package Outline SSOP16

■ PIN CONNECTION

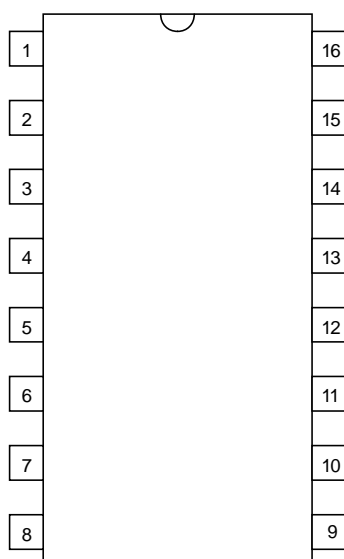

1.FR	9.Ilimit
2.Vref	10.WL
3.H1	11.VL
4.H2	12.UL
5.H3	13.WH
6.OSC	14.VH
7.Verr	15.UH
8.GND	16.VCC

NJM2626V

NJM2626

■ BLOCK DIAGRAM

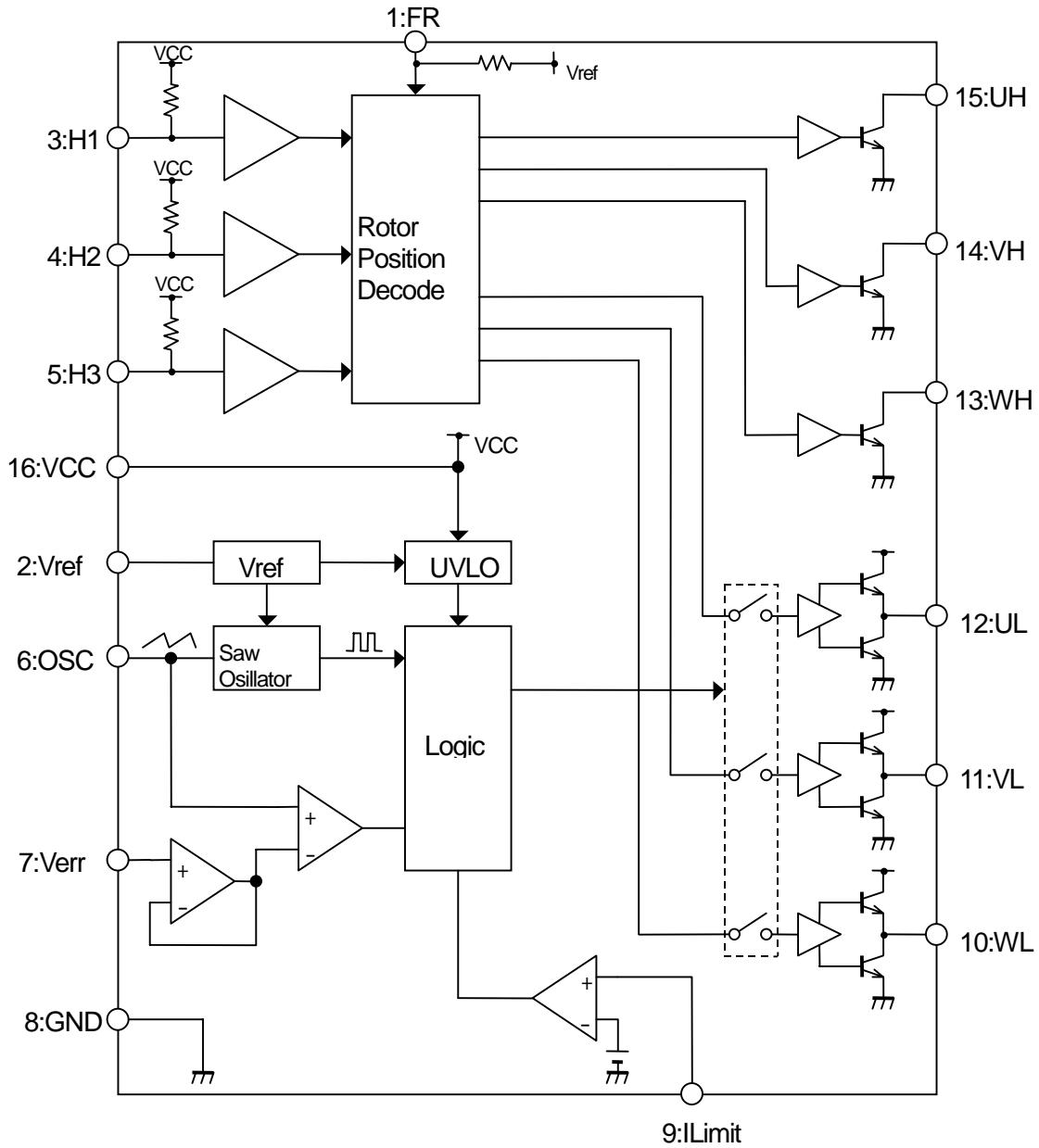

■ ABSOLUTE MAXIMUM RATINGS (Ta=25°C)

PARAMETER	SYMBOL	RATINGS	UNIT
Maximum Supply Voltage	V _{CC}	28	V
Maximum Output Current	I _O MAX	40	mA
Power Dissipation	P _D	300 (Device itself) 640 (NOTE1)	mW
Operating Temperature Range	T _{opr}	-40 ~ +85	°C
Storage Temperature range	T _{stg}	-50 ~ +150	°C

NOTE 1 : EIA/JEDEC STANDARD Test board (76.2*114.3*1.6mm, 2layers, FR-4) mounting

■ ELECTRICAL CHARACTERISTICS (V_{CC}=12V, C_t=1000pF, C_{ref}=1μF, Ta=25°C)

Total Device

PARAMETER	SYMBOL	TEST CONDITION	MIN.	TYP.	MAX.	UNIT
Operation Supply Voltage	V _{CC}	-	6.0	-	26.0	V
Under Voltage Sense Voltage	UVLO	Output Enable V _{CC} Decreasing	4.5	5.0	5.5	V
Hysteresis Voltage (Under Voltage Lock Out)	ΔUVLO	-	0.35	0.45	0.55	V
Supply Current	I _{CC}	RL=∞	-	12.0	18.0	mA

Reference Voltage Section

PARAMETER	SYMBOL	TEST CONDITION	MIN.	TYP.	MAX.	UNIT
Reference Voltage Output	V _{ref}	I _{ref} =1.0mA	3.6	4.0	4.4	V
Line Regulation	ΔV _{refL}	V _{CC} =6V ~ 18V	-	50	100	mV
Load Regulation	ΔV _{refLO}	I _{ref} =1.0mA ~ 20.0mA	-	15	50	mV

Hall Amplifier Section

PARAMETER	SYMBOL	TEST CONDITION	MIN.	TYP.	MAX.	UNIT
Input H Level Voltage	V _{hH}	-	V _{CC} -0.8	-	-	V
Input L Level Voltage	V _{hL}	-	-	-	0.8	V
Input Bias Voltage	I _{ho}	V _{in} =0.8V	-	-	-400	nA
Pull-up Resistance	R _{PUH}	V _{in} =0.8V	7	10	13	kΩ

Output Section

PARAMETER	SYMBOL	TEST CONDITION	MIN.	TYP.	MAX.	UNIT
Under Arm Output Voltage 1	V _{OH} (D)	I _{source} =30mA	10	10.3	-	V
Under Arm Output Voltage 2	V _{OL} (D)	I _{sink} =30mA	-	0.5	1.0	V
Output Clamp Voltage	V _{CL} (D)	V _{CC} =26V	-	18	20	V
Upper Arm Output Voltage	V _{OL} (U)	I _{sink} =30mA	-	0.5	1.0	V
Output Leak Current	I _O LEAK	-	-	-	1.0	μA

NJM2626

■ ELECTRICAL CHARACTERISTICS ($V_{CC}=12V$, $C_t=1000pF$, $C_{ref}=1\mu F$, $T_a=25^\circ C$)

Over Current Sense Section

PARAMETER	SYMBOL	TEST CONDITION	MIN.	TYP.	MAX.	UNIT
Sense Voltage	V_{TH}	-	0.45	0.50	0.55	V
Hysteresis Voltage	V_{THhys}	-	-	0.1	-	V
Input Voltage Ratio	V_{IN}	-	-	-	3.0	V
Input Bias Current	I_{IB}	$V_{IN}=0V$	-	-0.9	-5.0	μA

Oscillator Section

PARAMETER	SYMBOL	TEST CONDITION	MIN.	TYP.	MAX.	UNIT
Oscillator Frequency	f_{osc}	-	22	27	33	kHz
Supply Voltage Change Ratio	$\Delta f_{osc}/\Delta V$	$V_{CC}=6V \sim 18V$	-	1	5	%
PWM0% Sense Voltage	PWM0	PWM DUTY=0%	-	-	0.35	V
PWM100% Sense Voltage	PWM1	PWM DUTY=100%	3.5	-	-	V
Saw Wave Peak Voltage	$V_{p_{fosc}}$	-	2.4	2.8	3.2	V
Saw Wave Bottom Voltage	$V_{b_{fosc}}$	-	0.75	0.9	1.05	V

Error Amplifier Section

PARAMETER	SYMBOL	TEST CONDITION	MIN.	TYP.	MAX.	UNIT
Input Offset Voltage	V_{IO}	-	-	7	-	mV
Input Bias Current	I_{IBRR}	-	-	-46	-	nA
Input Common Mode Voltage Range	V_{ICMRR}	-	0	-	Vref	V

Forward or Reverse Direction Section (FR input terminal)

PARAMETER	SYMBOL	TEST CONDITION	MIN.	TYP.	MAX.	UNIT
Output Forward Direction	V_F	-	Vref-0.8	-	Vref	V
Output Reverse Direction	V_R	-	-	-	0.8	V
Hysteresis Voltage Ratio	ΔV_{FR}	-	-	0.5	-	V
Pull-Up Resistance	$R_{PU_{FR}}$	-	7	10	13	$k\Omega$

(note) Output switch test are performed under pulsed conditions to minimize power dissipation.

■ HALL INPUT vs HALL OUTPUT TRUTH TABLE

FR=L			FR=H			H:Source,L:Sink,X:Hi-Z					
H1	H2	H3	H1	H2	H3	UH	VH	WH	UL	VL	WL
H	L	H	L	H	L	X	L	X	H	L	L
H	L	L	L	H	H	X	X	L	H	L	L
H	H	L	L	L	H	X	X	L	L	H	L
L	H	L	H	L	H	L	X	X	L	H	L
L	H	H	H	L	L	L	X	X	L	L	H
L	L	H	H	H	L	X	L	X	L	L	H

■ FR INPUT TERMINAL

Terminal Voltage	Direction
L input	F
H input	R

■ TYPICAL APPLICATION

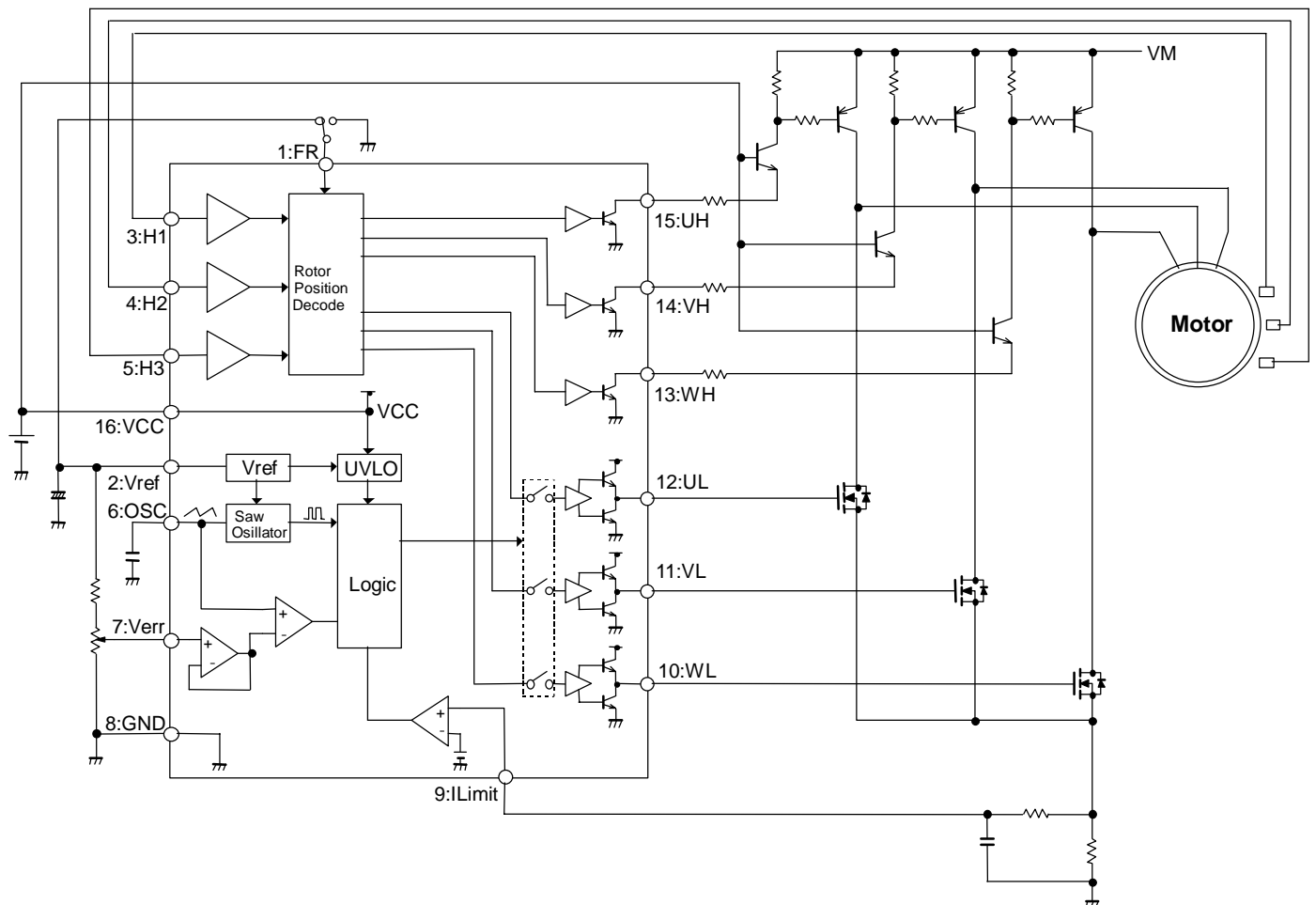

- A rotation direction change must be made after motor stopped completely.
- When PWM duty is extremely small, two or more switching elements can not be driven entirely. In such case, switching elements will generate excess heat and it may cause destruction of the switching devices. Therefore, extensive heat evaluation is necessary for switching device selection particularly in consideration of the area of safety operation (ASO).

NJM2626

TYPICAL CHARACTERISTICS

ICC vs. VCC

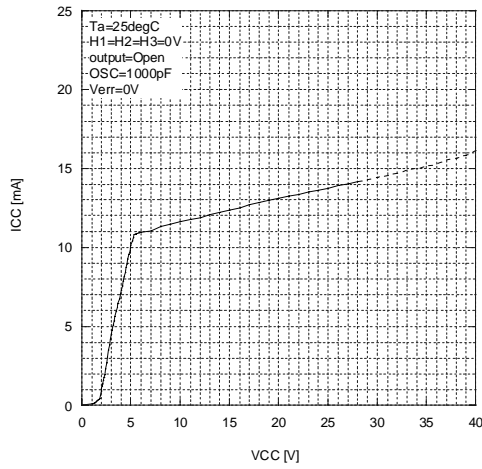

ICC vs. Temperature

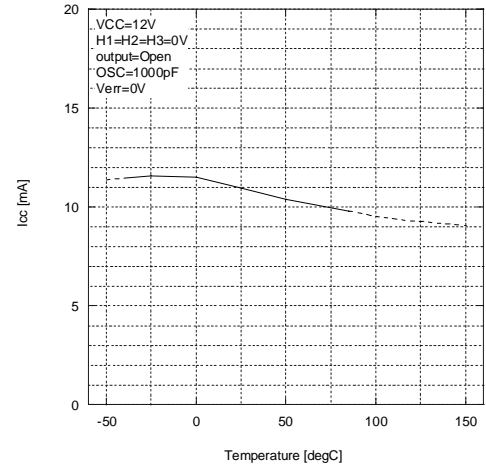

UVLO vs. Temperature

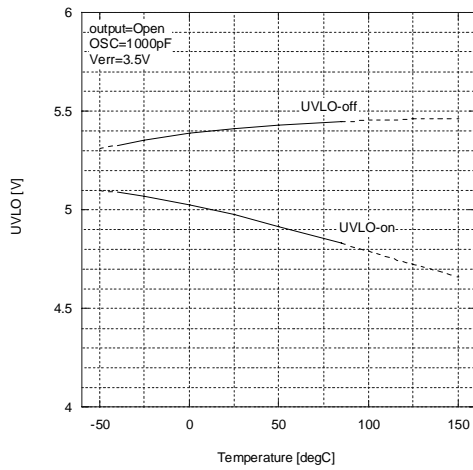

dUVLO vs. Temperature

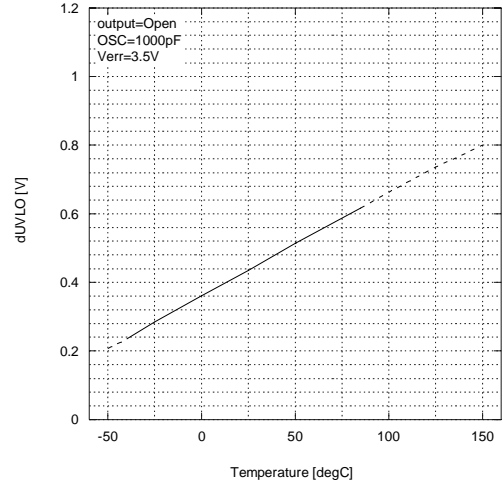

Vref vs. VCC

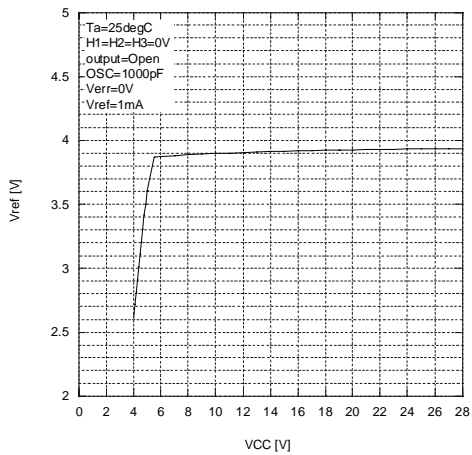

Vref vs. Io

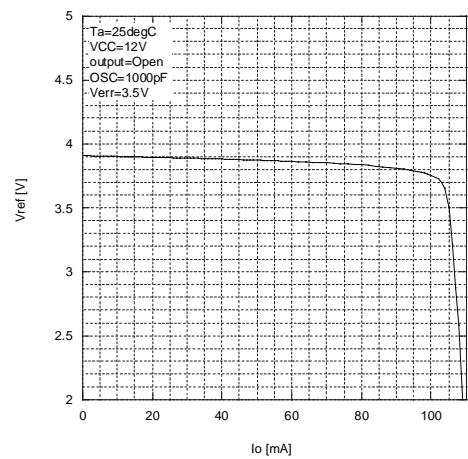

TYPICAL CHARACTERISTICS

Vref vs. Temperature

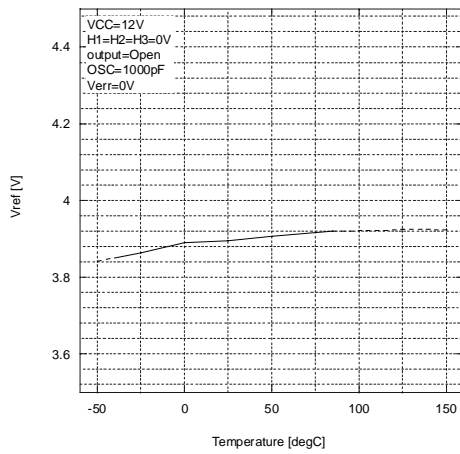

dVFR vs. Temperature

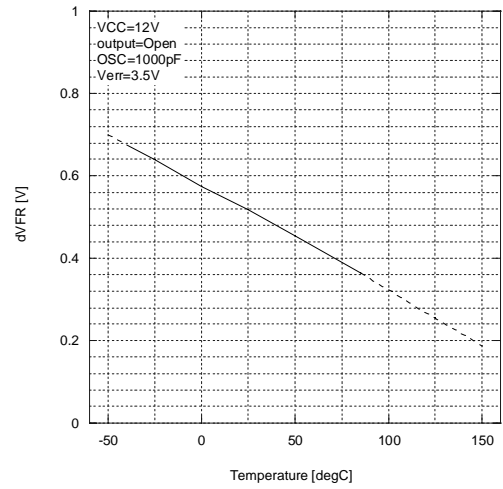

VhH-L vs. Temperature

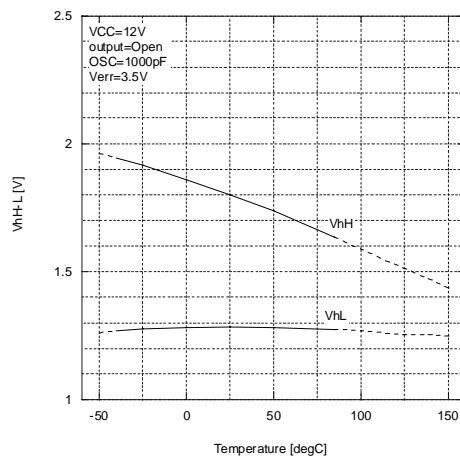

VOH(D) vs. Io

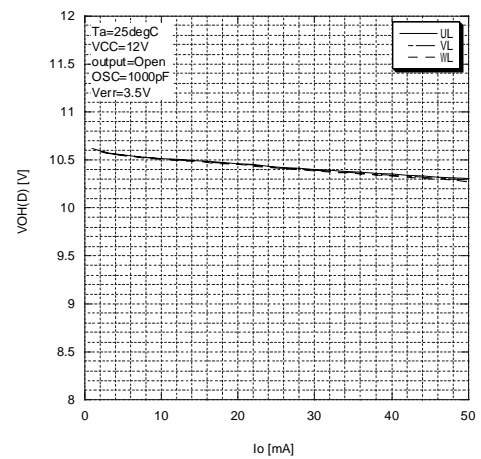

VOH-d vs. Temperature

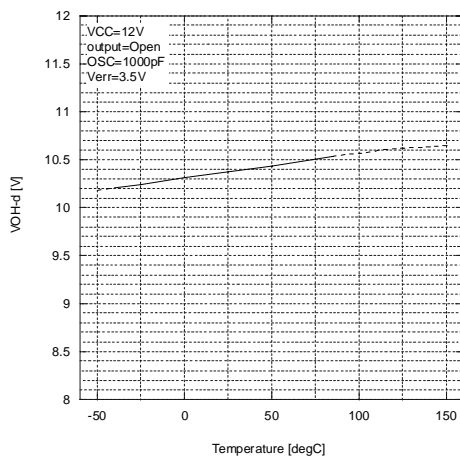

VOL(D) vs. Io

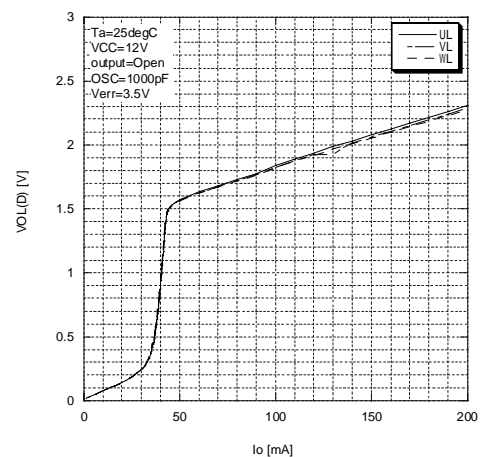

TYPICAL CHARACTERISTICS

VCL vs. Temperature

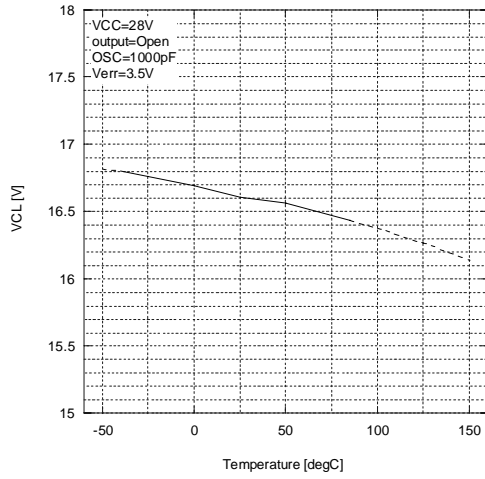

VTH vs. Temperature

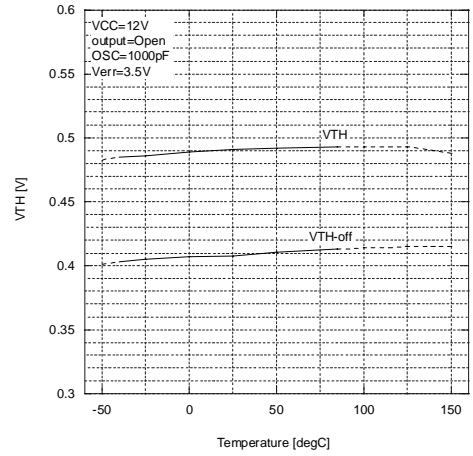

fosc vs. VCC

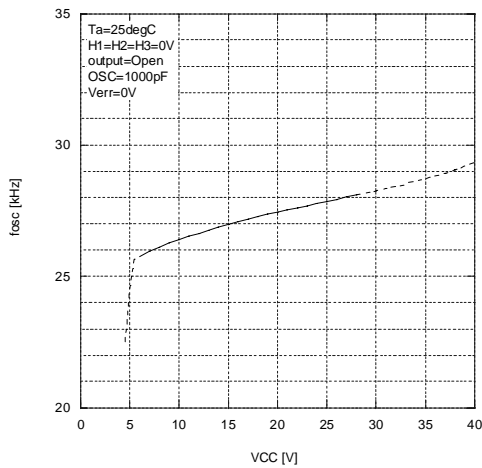

fosc vs. Temperature

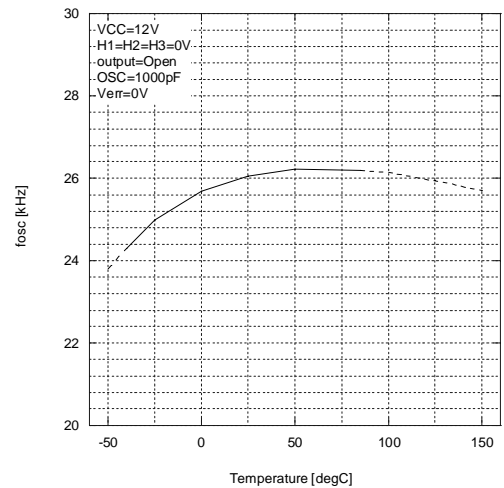

RPU-FR vs. Temperature

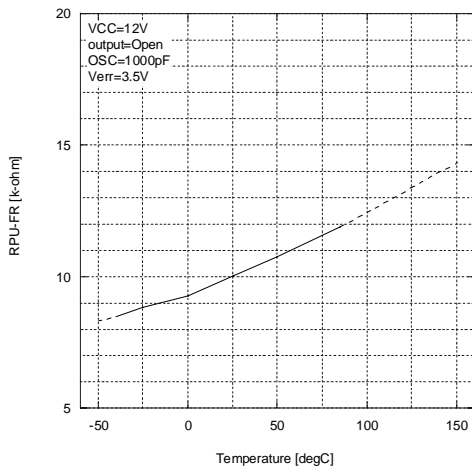

[CAUTION]
 The specifications on this databook are only given for information, without any guarantee as regards either mistakes or omissions. The application circuits in this databook are described only to show representative usages of the product and not intended for the guarantee or permission of any right including the industrial rights.