

MAXIM

MAX1993 Evaluation Kit

General Description

The MAX1993 evaluation kit (EV kit) demonstrates the MAX1993's standard 4A application circuit. This DC-to-DC converter steps down high-voltage batteries and/or AC adapters, generating a precision, low-voltage rail for use as chipset, DRAM, and other low-voltage supplies.

The MAX1993 EV kit provides a dynamically adjustable 1.0V/1.5V output voltage from 7V to 24V battery input range. It delivers up to 4A output current with greater than 90% efficiency. The EV kit operates at 300kHz switching frequency and has superior line- and load-transient response.

This EV kit is a fully assembled and tested circuit board. It also allows the evaluation of other dynamically adjustable output voltages in the 0.7V to 5.5V range by changing R6, R7, and R8 resistors.

This EV kit can also be used to evaluate the MAX1992, which has preset 1.8V/2.5V output voltages.

Features

- ◆ 7V to 24V Input Voltage Range
- ◆ Preset 1.8V/2.5V Output Voltages (Adjustable from 0.7V to 5.5V, MAX1992)
- ◆ Dynamically Selectable Output Voltages 1.0V/1.5V (Adjustable from 0.7V to 5.5V, MAX1993)
- ◆ 4A Output Current
- ◆ 300kHz Switching Frequency
- ◆ Selectable Inductor Saturation Protection
- ◆ Power-Good Output
- ◆ Selectable Overvoltage/Undervoltage Protection
- ◆ Low-Profile Components
- ◆ Fully Assembled and Tested

Ordering Information

PART	TEMP RANGE	IC PACKAGE
MAX1993EVKIT	0°C to +70°C	24 Thin QFN 4mm x 4mm

Component List

DESIGNATION	QTY	DESCRIPTION
C1	1	10 μ F, 25V ceramic capacitor (1812) Taiyo Yuden TMK432BJ106KM or TDK C4532X5R1E106M
C2	1	270 μ F, 2.5V, 9m Ω low-ESR capacitor Sanyo 2R5TPE220M9
C3, C7	2	1 μ F, 10V X5R ceramic capacitors (0805) Taiyo Yuden LMK212BJ105KG or TDK C2012X5R105M
C4	1	0.1 μ F ceramic capacitor (0603)
C5	1	470pF ceramic capacitor (0603)
C6	1	0.22 μ F, 16V X5R ceramic capacitor (0805) Taiyo Yuden EMK212BJ224KG
C8	1	1000pF ceramic capacitor (0603)
C9	1	10 μ F, 6.3V X5R ceramic capacitor (0805) TDK C2012X5R0J106M or Taiyo Yuden AMK212BJ106MG
C10, C11, C12	0	Not installed (0603)
D1	1	1A, 30V Schottky diode Nihon EP10QY03 or Nihon EC10QS03
D2	1	100mA, 30V Schottky diode Central Semiconductor CMPSH-3
JU1, JU2, JU3	3	3-pin headers

DESIGNATION	QTY	DESCRIPTION
JU4	1	4-pin header
L1	1	2.5 μ H, 7.5A power inductor Sumida CDRH104R-2R5
N1A, N1B	2	Dual N-channel MOSFETs Fairchild FDS6982A
R1, R11, R12, R22	4	0 Ω resistors (0603)
R2, R3, R13–R17, R20, R21	0	Not installed (0603)
R4	1	100k Ω \pm 1% resistor (0603)
R5	1	49.9k Ω \pm 1% resistor (0603)
R6, R7	2	75k Ω \pm 1% resistors (0603)
R8	1	150k Ω \pm 1% resistor (0603)
R9	1	100k Ω \pm 5% resistor (0603)
R10	1	20 Ω \pm 5% resistor (0805)
R18	1	0.015 Ω \pm 1%, 1/2W resistor (2010) IRC LR2010-01-R015-F or Dale WSL-2010-R015F
R19	0	Not installed (short PC trace) (0805)
U1	1	MAX1993ETG (24-pin thin QFN)
None	4	Shunts
None	4	Rubber feet
None	1	MAX1993 PC board

MAX1993 Evaluation Kit

Component Suppliers

SUPPLIER	PHONE	FAX	WEBSITE
Central Semiconductor	516-435-1110	516-435-1824	www.centralsemi.com
Dale-Vishay	402-564-3131	402-563-6296	www.vishay.com
IRC	361-992-7900	361-992-3377	www.ircct.com
Fairchild	408-721-2181	408-721-1635	www.fairchildsemi.com
Nihon	847-843-7500	847-843-2798	www.niec.co.jp
Taiyo Yuden	408-573-4150	408-573-4159	www.t-yuden.com
TDK	847-390-4373	847-390-4428	www.component.tdk.com
Sanyo	619-661-6835	619-661-1055	www.sanyovideo.com
Sumida	708-956-0666	708-956-0702	www.sumida.com

Note: Please indicate that you are using the MAX1993 when contacting these component suppliers.

Required Equipment

- 7V to 24V, power supply, battery, or notebook AC adapter
- DC bias power supply, 5V at 100mA
- Dummy load capable of sinking 4A
- Digital multimeter (DMM)
- 100MHz dual-trace oscilloscope

Quick Start

- 1) Ensure that the circuit is connected correctly to the supplies and dummy load prior to applying any power.
- 2) Verify that the shunts are across JU1 pins 1 and 2 (SHDN high), JU2 pins 1 and 2 (forced PWM), JU3 pins 2 and 3 (1.5V output), and JU4 pins 1 and 2 (OVP/UVF enabled).
- 3) Turn on battery power prior to +5V bias power; otherwise, the output UVLO timer times out and the FAULT latch is set, disabling the regulator until +5V power is cycled or shutdown is toggled.
- 4) Observe the 1.5V output with the DMM and/or oscilloscope. Look at the LX switching node and MOSFET gate-drive signals while varying the load current.

Detailed Description

Jumper Settings Evaluating Other Dynamic Output Voltages

The EV kit output is preset to 1.0V/1.5V. However, the output voltage can also be adjusted between 0.7V and 2V (FB = OUT) by selecting R6, R7, and R8 values. The

Table 1. Jumper JU1 Functions (Shutdown Mode)

JU1	SHDN PIN	MAX1993 OUTPUT
1 and 2 (default)	Connected to V _{CC}	MAX1993 enabled
2 and 3	Connected to GND	Shutdown mode
Not installed	SHDN must be driven by an external signal; connected to SHDN pad	MAX1993 operation depends on the external SHDN signal levels

Table 2. Jumper JU2 Functions (Low-Noise Mode)

JU2	SKIP PIN	OPERATIONAL MODE
1 and 2 (default)	Connected to V _{CC}	Low-noise mode, forced-PWM operation
2 and 3	Connected to GND	Normal operation; allows automatic PWM/PFM switchover for pulse skipping at light load, resulting in highest efficiency

MAX1993 regulates FB to the voltage set at REFIN. By changing the voltage at REFIN, the MAX1993 can be used in applications that require dynamic output-voltage changes between two set points. Using the GATE signal and open-drain output (OD), a resistor can be switched in and out of the REFIN resistor-divider, changing the voltage at REFIN. A logic high on GATE turns on the internal N-channel MOSFET, forcing OD to a low-impedance state. A low logic on GATE disables the N-channel MOSFET, so OD is high impedance. The

MAX1993 Evaluation Kit

Evaluates: MAX1992/MAX1993

Table 3. Jumper JU3 Functions (GATE—MAX1993 Only)

JU3	GATE PIN	MAX1993 OUTPUT
1 and 2	Connected to V _{CC}	A logic high on GATE turns on the internal MOSFET, pulling OD to ground, V _{OUT} = 1.0V.
2 and 3 (default)	Connected to GND	A logic low on GATE turns off the internal MOSFET so that OD appears as a high impedance, V _{OUT} = 1.5V.
Not installed	GATE must be driven by an external signal; connected to GATE pad	V _{OUT} depends on the external GATE signal levels.

Table 4. Jumper JU4 Functions (Overvoltage/Undervoltage Protection Selection)

JU4	OVP/UVP PIN	UVP	OVP/DISCHARGE MODE
1 and 2 (default)	Connected to V _{CC}	UVP is enabled; UVP threshold is 70% of nominal.	OVP is enabled; OVP threshold is 116% of nominal.
1 and 3	Connected to REF	UVP is enabled.	OVP and discharge mode are disabled.
1 and 4	Connected to GND	UVP is disabled.	OVP and discharge mode are disabled.
Not installed	Floating	UVP is disabled.	OVP and discharge mode are enabled.

Note: The MAX1993 detects and latches the discharge mode state set by OVP/UVP on startup.

two output voltages (FB = OUT) are determined by the following equations:

$$V_{OUT(LOW)} = V_{REF} (R7 / (R6 + R7))$$

$$V_{OUT(HIGH)} = V_{REF} (R7 + R8) / (R6 + R7 + R8)$$

where V_{REF} = 2.0V.

Table 5. Jumper JU5 Functions (Switching-Frequency Selection)

JU5	TON PIN	FREQUENCY (kHz)
1 and 2	Connected to V _{CC}	200
1 and 3	Connected to REF	450
1 and 4	Connected to GND	600
Not installed (default)	Floating	300 (as shipped)

Note: Do not change the operating frequency without first recalculating component values, because the frequency has a significant effect on preferred inductor value, peak current-limit level, MOSFET heating, PFM/PWM switchover point, output noise, efficiency, and other critical parameters.

Refer to the MAX1993 data sheet for selection of output capacitor and inductor values for output voltages greater than 2V.

Evaluating the MAX1992

This EV kit can also be used to evaluate the MAX1992 by following these steps:

- 1) Remove the MAX1993 and install the MAX1992.
- 2) Short pin 21 (AGND) to pin 20 (PGND) at the IC pins.
- 3) Remove the shunt from JU3 (GATE open).
- 4) Install resistors R1 and R2 for the desired output voltage.

The MAX1992 provides a fixed 1.8V output when FB is connected to V_{CC} (R3 = short, R1 and R2 = open) or a fixed 2.5V output when FB is connected to GND (R2 = short, R1 and R3 = open).

The output voltage can also be adjusted from 0.7V to 5.5V using a resistive voltage-divider formed by R1 and R2. The MAX1992 regulates FB to a fixed reference voltage (0.7V).

The adjusted output voltage is:

$$V_{OUT} = V_{FB} (1 + R1/R2)$$

where V_{FB} = 0.7V.

Refer to the MAX1992 data sheet for selection of output capacitor and inductor values for different output voltages.

MAX1993 Evaluation Kit

Evaluates: MAX1992/MAX1993

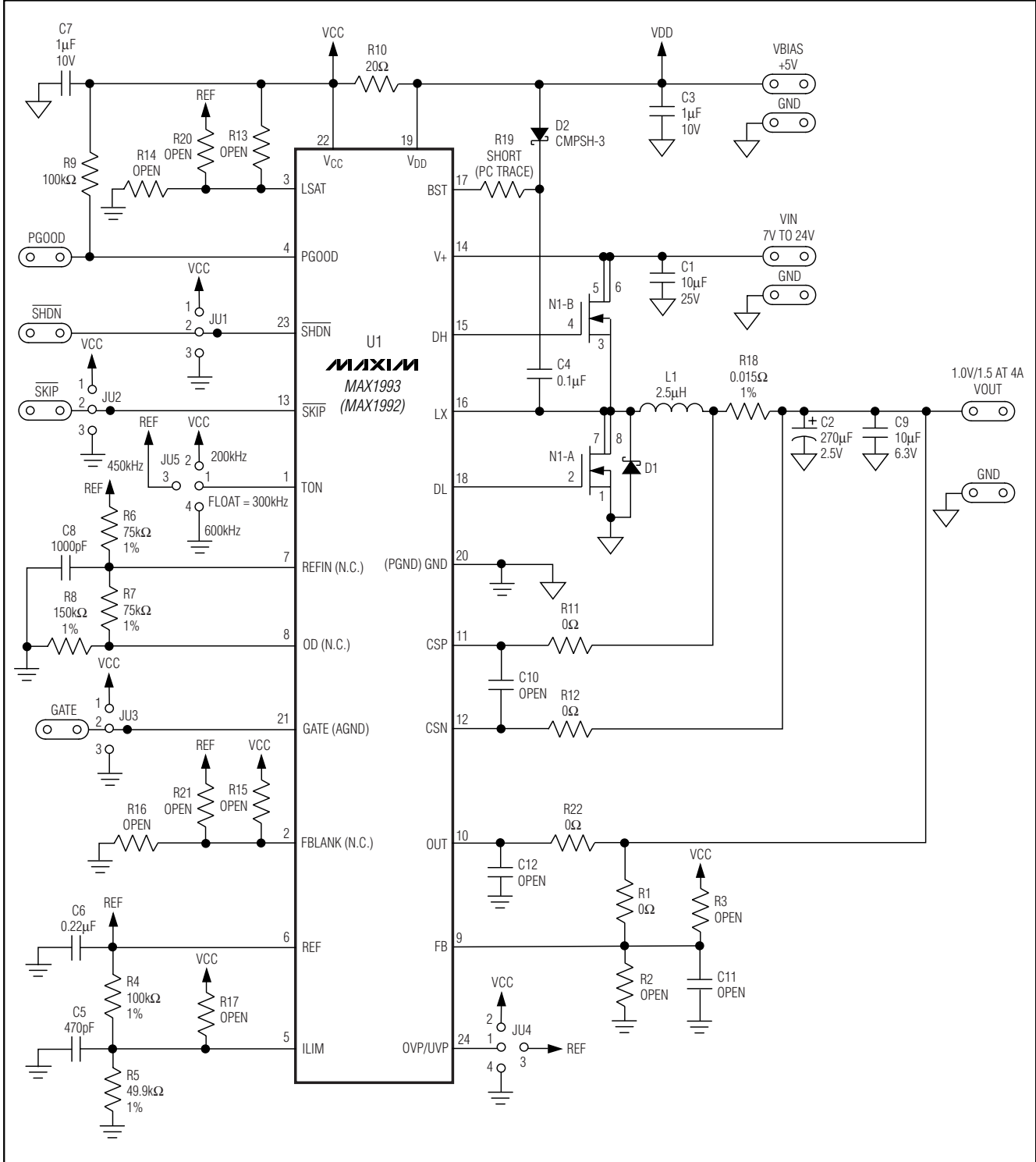

Figure 1. MAX1993 EV Kit Schematic

MAX1993 Evaluation Kit

Evaluates: MAX1992/MAX1993

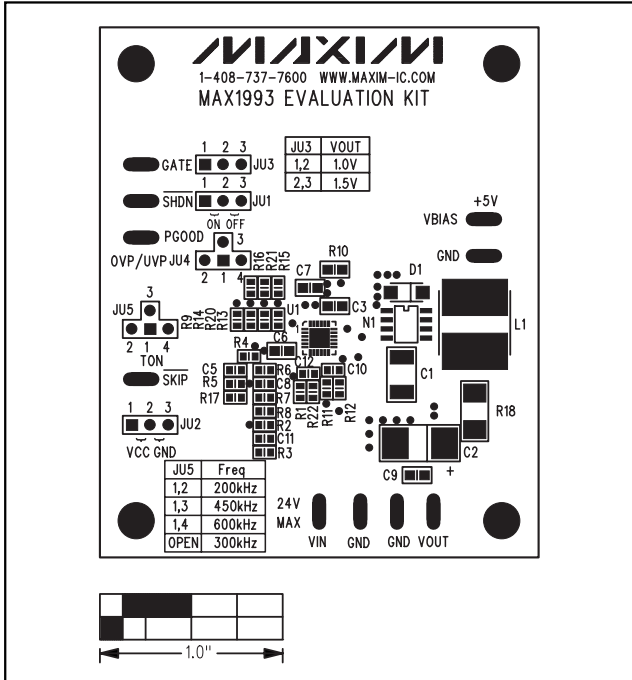

Figure 2. MAX1993 EV Kit Component Placement Guide—Component Side

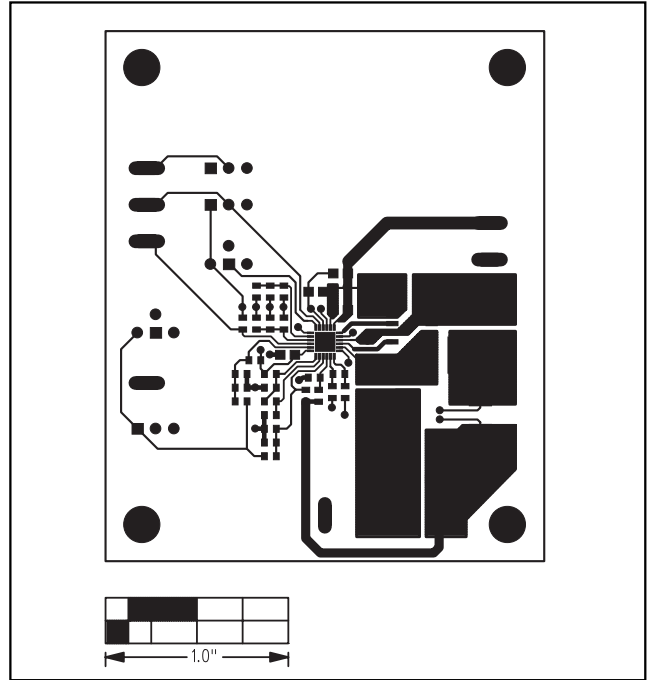

Figure 3. MAX1993 EV Kit PC Board Layout—Component Side

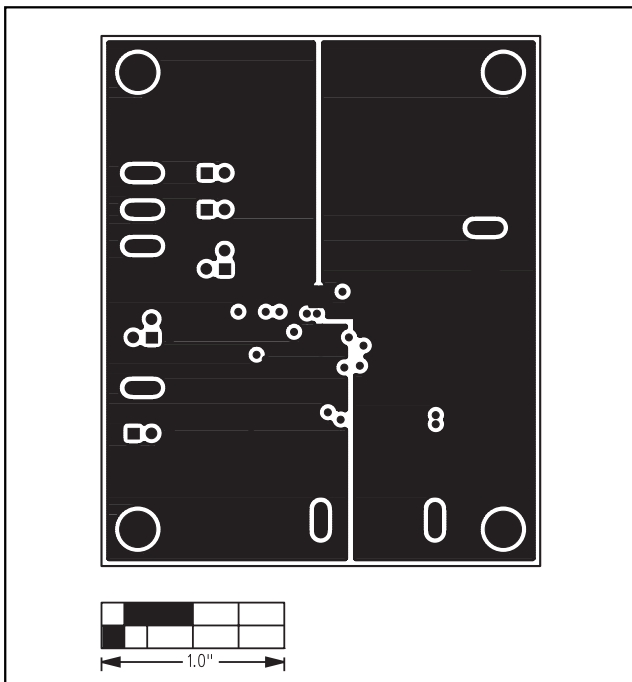

Figure 4. MAX1993 EV Kit PC Board Layout—GND Layer 2

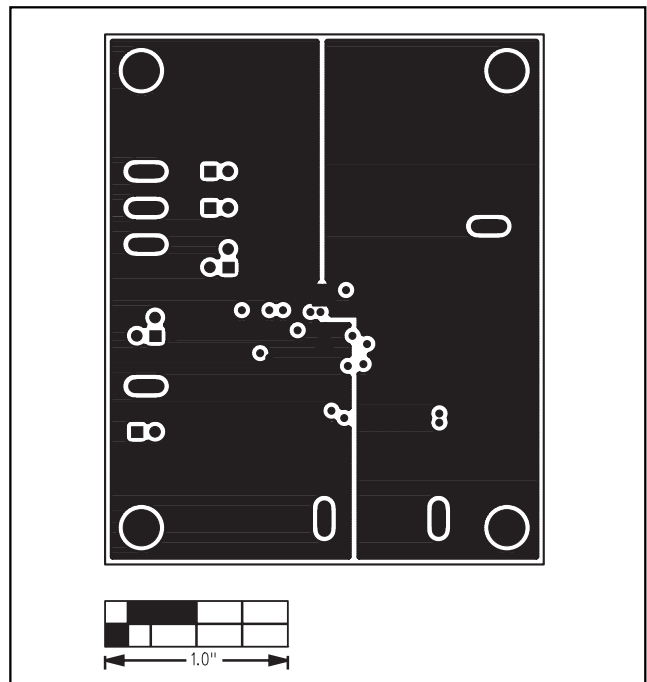

Figure 5. MAX1993 EV Kit PC Board Layout—GND Layer 3

MAX1993 Evaluation Kit

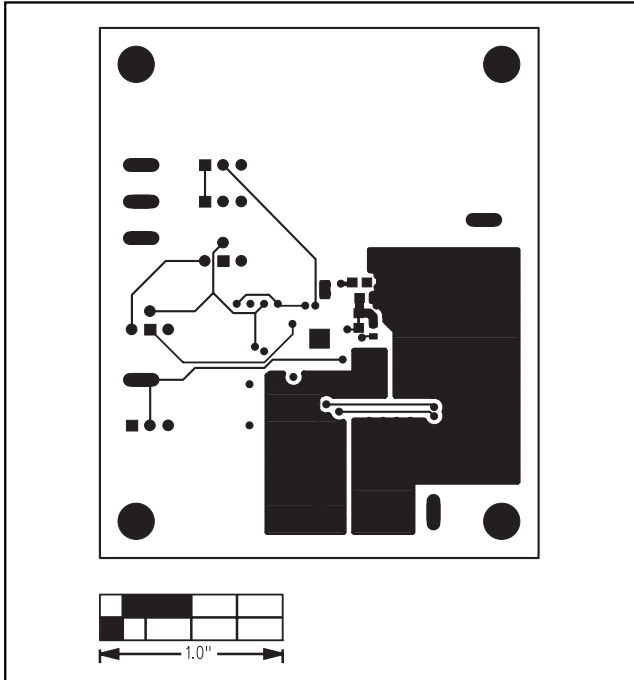

Figure 6. MAX1993 EV Kit PC Board Layout—Solder Side

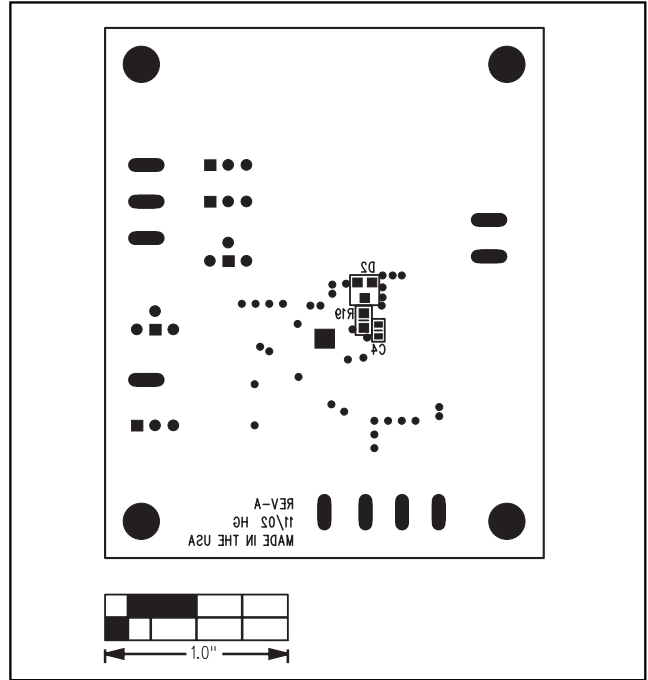

Figure 7. MAX1993 EV Kit Component Placement Guide—Solder Side

Maxim cannot assume responsibility for use of any circuitry other than circuitry entirely embodied in a Maxim product. No circuit patent licenses are implied. Maxim reserves the right to change the circuitry and specifications without notice at any time.

6 _____ **Maxim Integrated Products, 120 San Gabriel Drive, Sunnyvale, CA 94086 408-737-7600**