

### General Description

The AAT4601A SmartSwitch™ is part of AnalogicTech™'s Application Specific Power MOSFET™ (ASPM™) product family. It is a 1.8A Current Limited P-channel MOSFET power switch designed for high-side load-switching applications. This switch operates with inputs ranging from 2.7V to 5.5V, making it ideal for both 3V and 5V systems. An integrated current-limiting circuit protects the input supply against large changes in load current which could cause the supply to fall out of regulation. The AAT4601A has protection from thermal overload which limits power dissipation and junction temperatures. The maximum current limit level will guarantee 1.8A can be delivered to the load; the actual threshold is programmed with a resistor from the SET pin to ground. The quiescent supply current is typically 12µA. In shutdown mode, the supply current decreases to less than 1µA.

The AAT4601A is available in 8-pin SOP, TSSOP, or MSOP specified over -40 to 85°C.

### Features

- 2.7V to 5.5V Input voltage range
- Programmable over current threshold
- Low quiescent current
  - 12µA typical
  - Less than 1µA with Switch off
- Only 2.5V needed for ON Control
- Thermal Shutdown
- Fault Flag
- 2ms Fault Blanking
- Undervoltage Lockout
- Temperature range -40 to 85°C
- 2kV ESD rating
- UL Approved—File No. E217765
- 8-pin SOP, TSSOP, or MSOP package

### Applications

- USB ports
- Notebook computers
- Peripheral ports
- Hot swap supplies



UL Recognized Component

### Typical Application

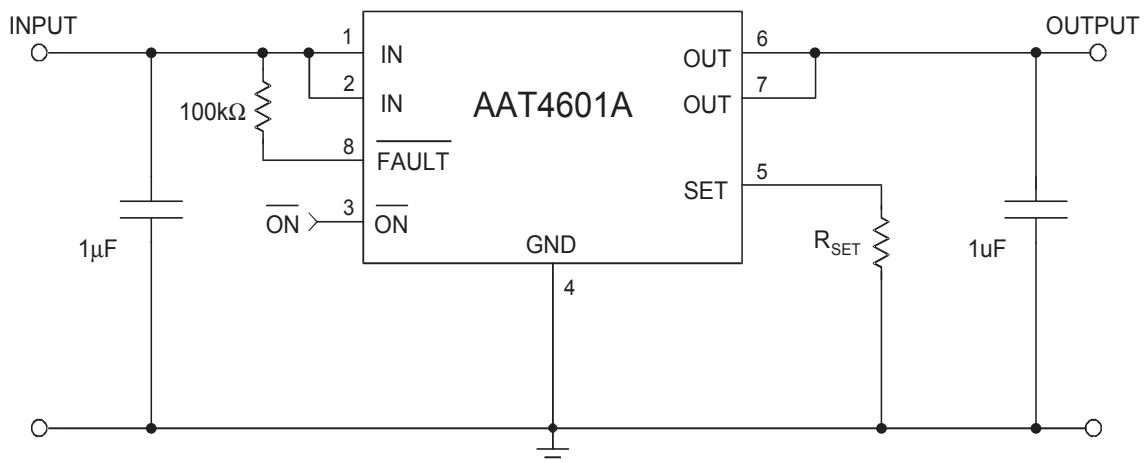

### Pin Descriptions

Pin #	Symbol	Function
1,2	IN	These pins are the input to the P-channel MOSFET source. Connect a 1 $\mu$ F capacitor from IN to GND.
3	$\overline{\text{ON}}$	Active-Low Enable Input. A logic low turns the switch on.
4	GND	Ground
5	SET	Current-Limit Set Input. A resistor from SET to ground sets the current limit for the switch.
6,7	OUT	These pins are the P-channel MOSFET drain connection. Connect a 1 $\mu$ F capacitor from OUT to GND.
8	$\overline{\text{FAULT}}$	Fault-Indication Output. This open-drain output goes low when in current limit or when the die temperature exceeds +135 °C, with a 2ms delay after the fault event occurs.

### Pin Configuration

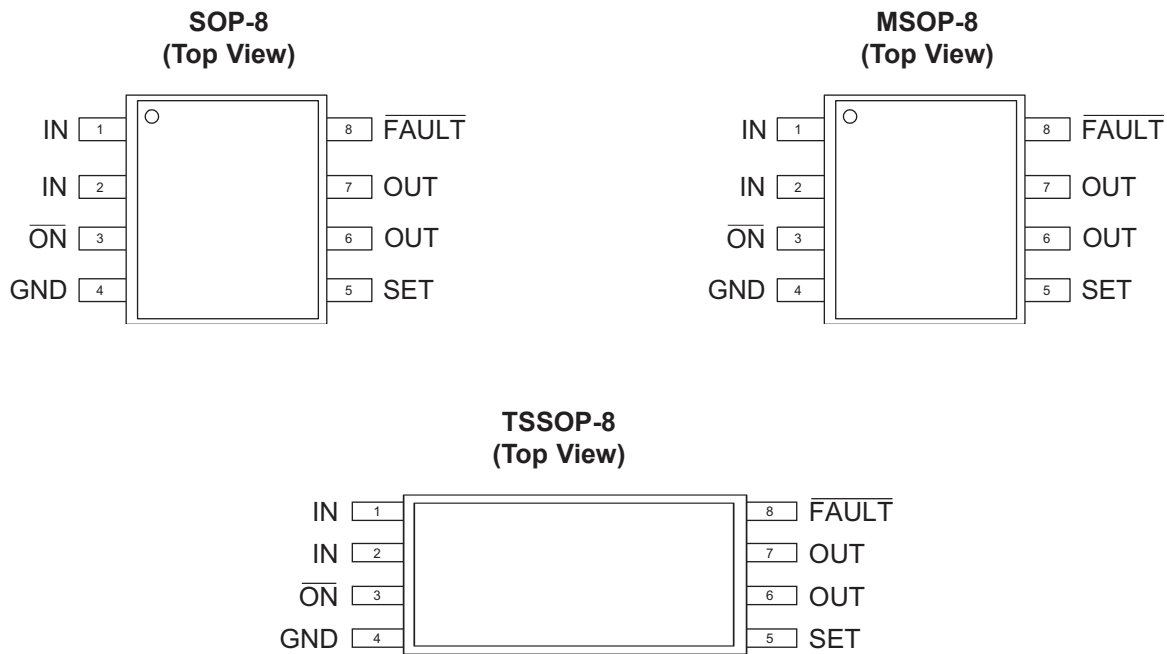

### Absolute Maximum Ratings (T<sub>A</sub>=25°C unless otherwise noted)

Symbol	Description	Value	Units
V <sub>IN</sub>	IN to GND	-0.3 to 6	V
V <sub>ON</sub> , V <sub>FAULT</sub>	ON, FAULT to GND	-0.3 to V <sub>IN</sub> +0.3	V
V <sub>SET</sub> , V <sub>OUT</sub>	SET, OUT to GND	-0.3 to V <sub>IN</sub> +0.3	V
I <sub>MAX</sub>	Maximum Continuous Switch Current	3	A
T <sub>J</sub>	Operating Junction Temperature Range	-40 to 150	°C
T <sub>LEAD</sub>	Maximum Soldering Temperature (at Leads)	300	°C
V <sub>ESD</sub>	ESD Rating—HBM <sup>1</sup>	4000	V

Note: Stresses above those listed in Absolute Maximum Ratings may cause permanent damage to the device. Functional operation at conditions other than the operating conditions specified is not implied. Only one Absolute Maximum rating should be applied at any one time.

Note 1: Human body model is a 100pF capacitor discharged through a 1.5kΩ resistor into each pin.

### Thermal Characteristics

Symbol	Description	Value	Units
Θ <sub>JA</sub>	Maximum Thermal Resistance (SOP-8) <sup>2</sup>	100	°C/W
Θ <sub>JA</sub>	Maximum Thermal Resistance (TSSOP-8) <sup>2</sup>	150	°C/W
Θ <sub>JA</sub>	Maximum Thermal Resistance (MSOP-8) <sup>2</sup>	150	°C/W
P <sub>D</sub>	Maximum Power Dissipation (SOP-8) <sup>2</sup>	1.25	W
P <sub>D</sub>	Maximum Power Dissipation (TSSOP-8) <sup>2</sup>	833	mW
P <sub>D</sub>	Maximum Power Dissipation (MSOP-8) <sup>2</sup>	833	mW

Note 2: Mounted on an FR4 printed circuit board.

**Electrical Characteristics** ( $V_{IN} = 5V$ ,  $T_A = -40$  to  $85^\circ C$  unless otherwise noted. Typical values are at  $T_A=25^\circ C$ )

Symbol	Description	Conditions	Min	Typ	Max	Units
$V_{IN}$	Operation Voltage		2.7		5.5	V
$I_Q$	Quiescent Current	$V_{IN} = 5V$ , $\overline{ON} = GND$ , $I_{OUT} = 0$		12	30	$\mu A$
$I_{Q(OFF)}$	Off Supply Current	$\overline{ON} = IN$ , $V_{IN} = 5.5V$		.004	1	$\mu A$
$I_{SD(OFF)}$	Off Switch Current	$\overline{ON} = IN$ , $V_{IN} = 5.5V$ , $V_{OUT} = 0$		.07	15	$\mu A$
$V_{UVLO}$	Undervoltage Lockout	Rising edge, 1% hysteresis,	2.0	2.3	2.7	V
$R_{DS(ON)}$	On-Resistance	$V_{IN}=5.0V$		70		m $\Omega$
		$V_{IN}=4.5V$		75	130	
		$V_{IN}=3.0V$		80	150	
		$V_{IN}=3.0V$ , $T_A=25^\circ C$		80	110	
$I_{LIM}$	Current Limit	$R_{SET} = 20.5k\Omega$	750	1000	1250	mA
$I_{LIM(MIN)}$	Minimum Current Limit			260		mA
OTMP	Shutdown Temperature	$V_{IN} = 5V$		125		$^\circ C$
$V_{ONL}$	$\overline{ON}$ Input Low Voltage				0.8	V
$V_{ONH}$	$\overline{ON}$ Input High Voltage	$V_{IN}=2.7V$ to $3.6V$	2.0			V
		$V_{IN}=4.5V$ to $5.5V$	2.4			
$I_{ONSINK}$	$\overline{ON}$ Input leakage	$V_{ON} = 5.5V$		0.01	1	$\mu A$
$V_{FAULTL}$	$\overline{FAULT}$ Logic Output Low Voltage	$I_{SINK}=1mA$		0.08	0.4	V
$I_{FSINK}$	$\overline{FAULT}$ Logic Output High Leakage	$V_{FAULT} = 5.5V$		0.05	1	$\mu A$
$T_{RESP}$	Current Limit Response Time	$V_{IN}=5V$		2		$\mu s$
$T_{BLANK}$	Fault Blanking Time after Turn-On			2		ms
$T_{OFF}$	Turn-Off Time <sup>3</sup>	$V_{IN}=5V$			20	$\mu s$
$T_{ON}$	Turn-On Time <sup>3</sup>	$V_{IN}=5V$			200	$\mu s$

Note 3: Guaranteed by design.

### Typical Characteristics

(Unless otherwise noted,  $V_{IN} = 5V$ ,  $T_A = 25^\circ C$ )

Quiescent Current vs. Temperature

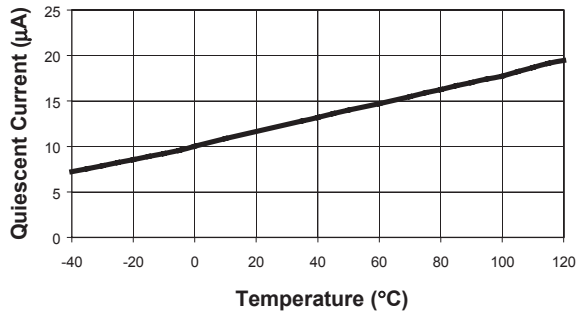

Quiescent Current

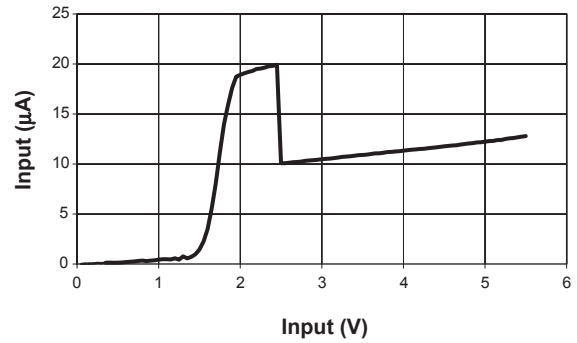

Current Limit ( $V_{IN} = 5.0V$ )

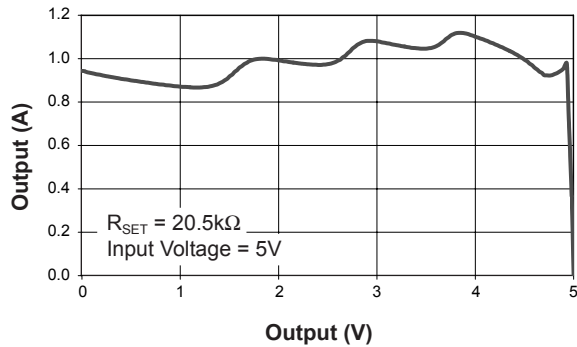

$R_{SET} * I_{LIM}$  Product vs.  $I_{LIM}$

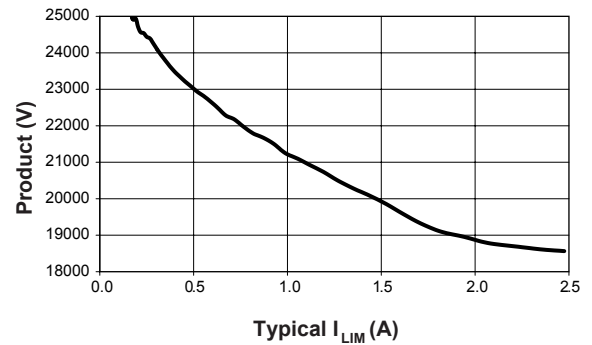

Off-Supply Current vs. Temperature

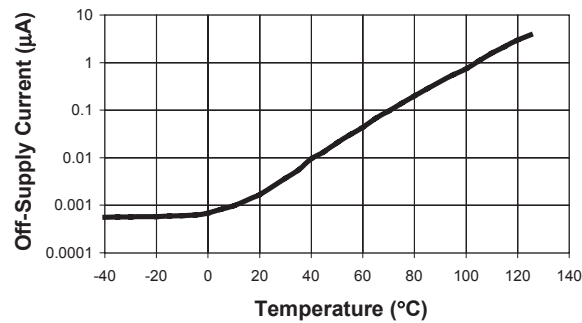

Off-Switch Current vs. Temperature

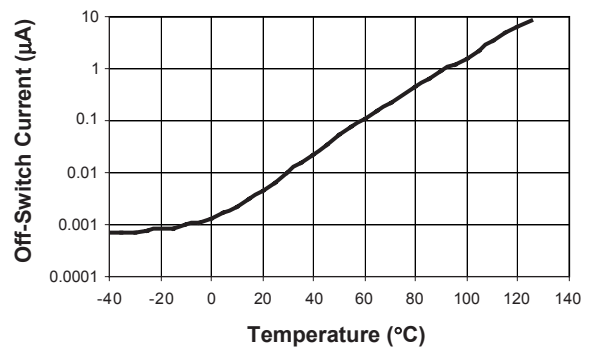

### Typical Characteristics

(Unless otherwise noted,  $V_{IN} = 5V$ ,  $T_A = 25^\circ C$ )

Turn-On vs. Temperature

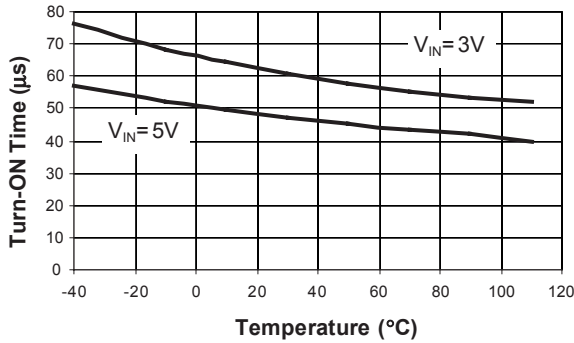

Turn-Off vs. Temperature

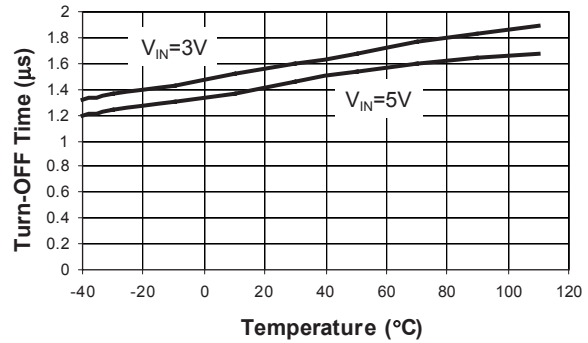

Switch Turn-On Time

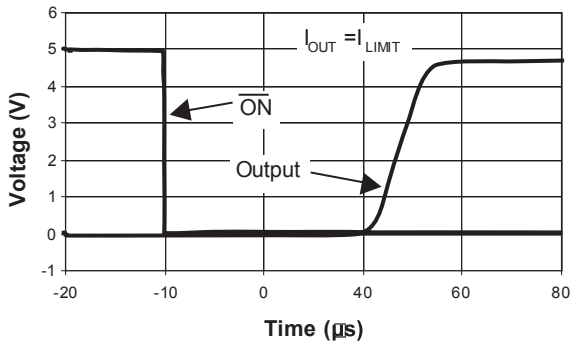

Switch Turn-Off Time

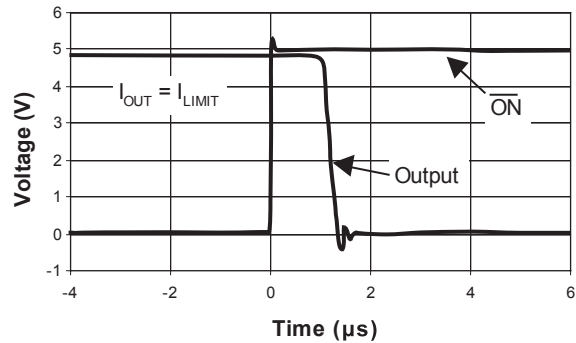

Short Circuit through  $0.3\Omega$

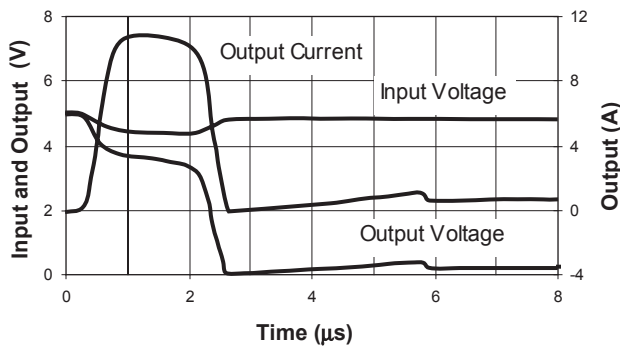

Short Circuit through  $0.6\Omega$

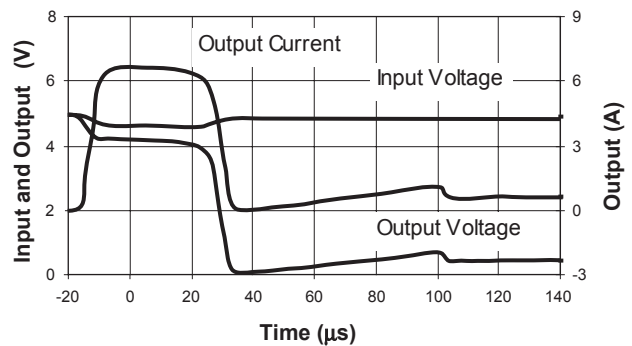

### Typical Characteristics

(Unless otherwise noted,  $V_{IN} = 5V$ ,  $T_A = 25^\circ C$ )

**Fault Delay vs. Temperature**

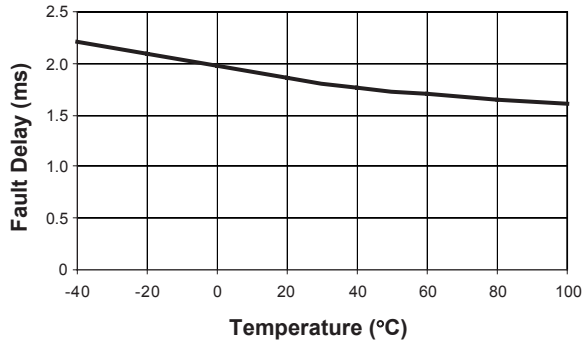

**$R_{DS(ON)}$  vs. Temperature**

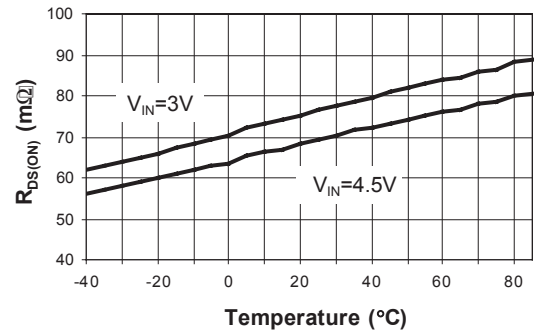

### Functional Block Diagram

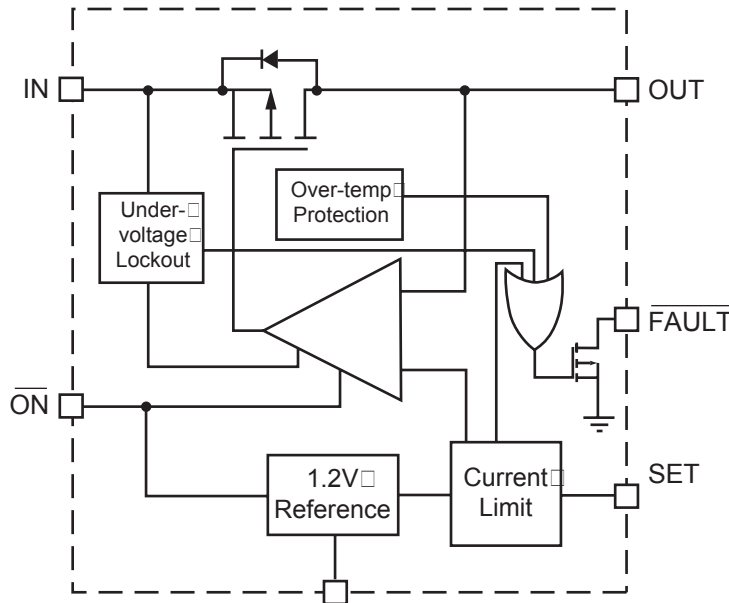

### Functional Description

The AAT4601A is an integrated MOSFET load switch with an adjustable current limit, over temperature protection, level shifted input and a fault flag. The current limit control is combined with an over temperature thermal limit circuit to provide a comprehensive system to protect the load switch under short circuit or other adverse operating conditions. The AAT4601A is ideally suited for control and protection of peripheral ports such as USB, RS232 and parallel ports.

The current limit and over temperature circuits will act independently. The device current limit is activated when the output load current exceeds an internal threshold level. The internal current limit threshold is determined by an external resistor connected between the SET pin and ground. The minimum current limit threshold is specified by  $I_{LIM(MIN)}$ . If the load switch ambient temperature becomes excessive or if a short circuit condition persists, the die temperature will rise causing the over temperature protection circuit to activate.

If a current limit level less than  $I_{LIM(MIN)}$  is required, the AAT4601A can be used to operate in foldback

current limit mode. To achieve this, an  $R_{SET}$  value can be chosen to program a current limit lower than  $I_{LIM(MIN)}$ ; in this case, when the load current reaches  $I_{LIM(MIN)}$ , the current will immediately drop, limiting at the programmed value.

If the current limit or over temperature protection circuits are active for more than two milliseconds, the system will be informed via the FAULT Flag. The two millisecond delay allows the AAT4601A to be turned on into capacitive loads without activating the FAULT Flag. The open drain FAULT output can be connected directly to system controllers driven by voltage levels less than the IN pin voltage without additional level shifting circuitry.

The load switch is turned off by applying a logic high level to the ON pin. The AAT4601A typically consumes 12 $\mu$ A when operating, when off, the device draws less than 1 $\mu$ A. In the off state, current is prevented from flowing between the input and output. The ON function has logic level thresholds that allow the AAT4601A to be TTL compatible and may also be controlled by 2.5V to 5.0V CMOS circuits. The voltage level on either ON or FAULT should not exceed the input supply level present on the IN pin.



### Applications Information

#### Setting Current Limit

A simple three-step procedure can be used to adjust the AAT4601A's current limit. First, the maximum current required by the load should be determined. Second, select a resistor that guarantees adequate current is available to the load under normal conditions. Finally, the maximum current that can pass through the switch can be calculated and compared to the maximum current available.

**Step 1:** The maximum current required by a load is usually defined in port specifications design application references. For example, USB ports are specified to support loads of up to 500 mA.

**Step 2:** The most convenient method for determining a current limit resistor value is to look it up in the provided table named "Current Limit  $R_{SET}$  Values". Find the lowest current value that is greater than the maximum load current in the given application. Refer to the column named "Device will not current limit below". The resistor value needed is in the corresponding row named " $R_{SET}$ ". For example, a USB port requires 500 mA. The lowest level where the device will current limit above 500 mA is 507 mA. The corresponding resistor value for  $R_{SET}$  would be 33k $\Omega$ .

**Step 3:** Now the required resistor value has been determined. The maximum current that can be drawn, even with a short circuit applied to the output, can be determined by reading the column labeled "Device always current limits below". If the power supply connected to the AAT4601A's input can provide this current level, the power supply voltage will not collapse when a short circuit is applied to the load switch output. For example, a notebook computer has a USB port which is powered by an AAT4601A with a 33k $\Omega$  resistor connected between the SET pin and GND. If the power supply connected to the AAT4601A's IN pin can provide more than 845 mA, this supply will remain in regulation even if a short circuit is applied to the USB port.

**Current Limit  $R_{SET}$  Values**

$R_{SET}$ (k $\Omega$ )	Current Limit typ (mA)	Device will not current limit below: (mA)	Device always current limits below: (mA)
7.5	2476	1857	3095
8.2	2277	1708	2847
9.1	2065	1549	2581
10	1895	1421	2369
11	1748	1311	2185
12	1633	1224	2041
13	1528	1146	1910
15	1353	1015	1691
16	1280	960	1600
18	1158	869	1448
20	1055	791	1318
22	972	729	1215
24	897	673	1122
27	811	608	1014
30	736	552	919
33	676	507	845
36	625	469	781
39	582	436	727
43	533	400	666
47	491	368	613
51	455	341	568
56	418	314	523
62	380	285	476
68	350	262	437
75	320	240	400
82	295	221	369
91	267	200	334
100	245	183	306
110	223	167	279
120	206	155	258
130	192	144	239
150	167	125	209
160	157	118	197

### Applications Information

#### Operation in Current Limit

If an excessive load is applied to the output of an AAT4601A, the load's current will be limited by the AAT4601A's current limit circuitry. Refer to the figure named "Overload Operation". If a short circuit were to occur on the load, it would demand more current than what is allowed by the internal current limiting circuit and the voltage at the AAT4601A's output will drop. This causes the AAT4601A to dissipate more power than in normal operation, causing the die temperature to increase. When die temperature exceeds the internal over temperature threshold, the AAT4601A will shut down. After shutting down, the AAT4601A cools to a level below the over temperature threshold, at which point it will start up again. The AAT4601A will continue to cycle off and on until one of the following events occurs; the load current is reduced to a level below the AAT4601A's current limit setting, the input power is removed, or until the output is turned off by a logic high level applied to the  $\overline{ON}$  pin.

#### Thermal Considerations

Since the AAT4601A has internal current limit and over temperature protection, junction temperature is rarely a concern. If an application requires a large load current in a high temperature operating environment, there is the possibility that the over temperature protection circuit rather than the current limit circuit will regulate the current available to the load. In these applications, the maximum current available without risk of activation of the over temperature circuit can be calculated. The maximum

internal temperature while current limit is not active can be calculated using Equation 1:

$$T_{J(MAX)} = I_{MAX}^2 \times R_{DS(ON)(MAX)} \times R_{\theta JA} + T_A(MAX)$$

In Equation 1,  $I_{MAX}$  is the maximum current required by the load.  $R_{DS(ON)(MAX)}$  is the maximum rated  $R_{DS(ON)}$  of the AAT4601A at high temperature.  $R_{\theta JA}$  is the thermal resistance between the AAT4601A's die and the board onto which it is mounted.  $T_A(MAX)$  is the maximum ambient temperature for the printed circuit board assembly under the AAT4601A when the load switch is not dissipating power. Equation 1 can be transformed to provide  $I_{MAX}$ ; Refer to Equation 2.

$$I_{MAX} = \sqrt{\frac{T_{SD(MIN)} - T_A(MAX)}{R_{DS(ON)(MAX)} \times R_{\theta JA}}}$$

$T_{SD(MIN)}$  is the minimum temperature required to activate the AAT4601A's over temperature protection. With typical specification of 125°C, 115°C is a safe minimum value to use.

For example, a portable device is specified to operate in a 50°C environment. The printed circuit board assembly will operate at temperatures as high as 85°C. This portable device has a sealed case and the area of the printed board assembly is relatively small causing  $R_{\theta JA}$  to be approximately 120°C/W. Using Equation 2,

$$I_{MAX} = \sqrt{\frac{115 - 85}{130 \times 120}} = 1.4 \text{ A}$$

If this system requires less than 1.4 A, the thermal limit will not activate during normal operation.

**Overload Operation**

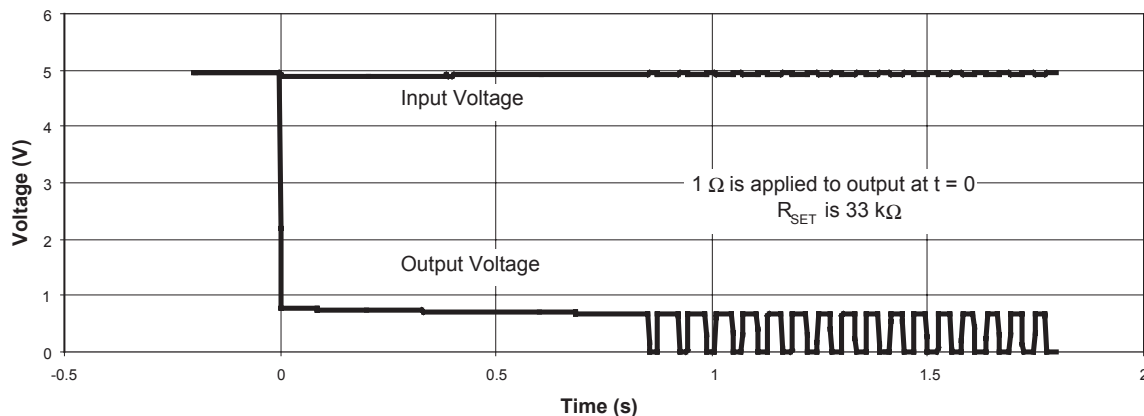

## Applications Information

### **Input Capacitor**

The input capacitor serves two purposes. First, it protects the source power supply from transient current effects generated by the application load circuit. If a short circuit is suddenly applied to the output of an AAT4601A, there is a microsecond long period during which a large current flow before the current limit circuitry activates. Refer to the characteristic curve named "Short Circuit Through 0.3Ω." A properly sized input capacitor can dramatically reduce the load switch input transient response effects seen by the power supply and other circuitry upstream from the AAT4601A.

The second purpose of the input capacitor is to prevent transient events generated by the load circuit from affecting the operation of the AAT4601A. For example, if an AAT4601A is used in a circuit that operates from a 3 volt power supply with poor step load response, it is possible that turning on the load switch could cause the input power supply to droop below the AAT4601A's under voltage lockout threshold. This drop in voltage would cause the AAT4601A to turn off until the input power supply's voltage recovers. Since this cycle would be self-perpetuating, the entire circuit could be seen to be unstable. In the very rare case where capacitor cost is prohibitive, the output load circuit should be slew rate limited when turned on.

### **Output Capacitor**

In order to insure stability while the device current limit is active, a small capacitance of approximately 1μF should be used. When the AAT4601A is activated using the  $\overline{\text{ON}}$  function, there are no momentary current transients as in the case of when a short circuit suddenly applied to a device that is already on. Refer to the characteristic curve named "Switch Turn-On Time." No matter how big the output capacitor, output current is limited to the value allowed by the threshold determined by  $R_{\text{SET}}$  and the internal current limiting circuitry. This permits very large output capacitors to be used.

For example, USB ports are specified to have at least 120μF of down stream capacitance from their controlling power switch. An output capacitance as large as 1000μF would not disturb the input power supply to the AAT4601A used to control the USB port.

### **$\overline{\text{ON}}$ Input**

When the AAT4601A is in the off state, the output is an open circuit and the device quiescent current consumption is reduced to less than 1μA. The  $\overline{\text{ON}}$  threshold voltage is set to allow the AAT4601A to be controlled by 5 volt TTL levels as well as CMOS power from 2.5 volts to 5 volts. The  $\overline{\text{ON}}$  function control voltage level should not exceed the input supply level applied to the IN pin.

### **FAULT Output**

A  $\overline{\text{FAULT}}$  flag is provided to alert a system if the load switch is not receiving a sufficient voltage level to operate properly. If either the current limit or over temperature circuits in any combination are active for more than approximately two milliseconds continuously, the  $\overline{\text{FAULT}}$  pin is pulled to ground internally through a 100Ω resistance. The 2 millisecond delay on the  $\overline{\text{FAULT}}$  function is intended to prevent capacitive loads connected to the load switch output from activating  $\overline{\text{FAULT}}$  when the device is turned on. The placement of a pull up resistor between the  $\overline{\text{FAULT}}$  pin and the IN pin is recommended. Reasonable values for the pull up resistor should range from 10kΩ to 100kΩ. Since  $\overline{\text{FAULT}}$  is an open drain terminal, it may be pulled up to any voltage that is not greater than the level present on the IN pin. This is done to allow the AAT4601A to signal ancillary circuitry that is powered by voltage level less than the level on the IN pin.

### **Reverse Voltage**

The AAT4601A is designed to control current flowing from IN to OUT. If a voltage is applied to OUT which is greater than that on IN, a large resulting reverse current may flow, potentially damaging the AAT4601A.

### Printed Circuit Board Layout Recommendations

For proper thermal management, and to take advantage of the low  $R_{DS(ON)}$  of the AAT4601A, a few circuit board layout rules should be followed:  $V_{IN}$  and  $V_{OUT}$  should be routed using wider than normal traces, and GND should be connected to a ground plane. For best performance,  $C_{IN}$  and  $C_{OUT}$  should be placed close to the package pins.

### Evaluation Board Layout

The AAT4601A evaluation layout follows the printed circuit board layout recommendations, and can be used for good applications layout.

Note: Board layout shown is not to scale.

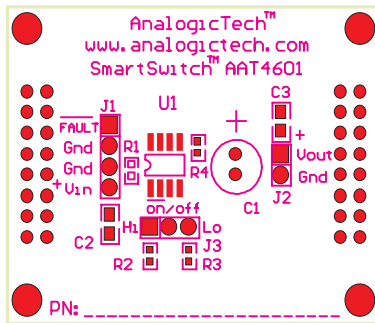

**Figure 1: AAT4601A Evaluation board top side silk screen assembly drawing**

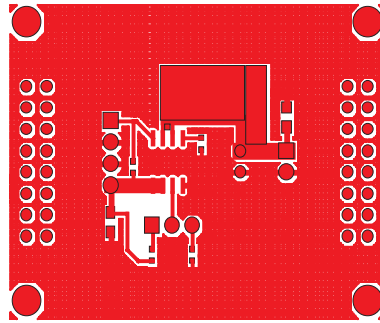

**Figure 2: AAT4601A Evaluation board component side layout**

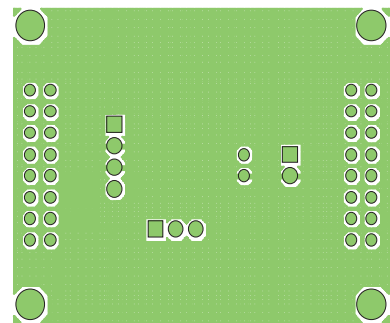

**Figure 3: AAT4601A Evaluation board solder side layout**

### Ordering Information

Package	Marking <sup>1</sup>	Part Number (Tape and Reel)
SOP-8		AAT4601AIAS-T1
TSSOP-8		AAT4601AIHS-T1
MSOP-8	MQXYY	AAT4601AIKS-T1

Note 1: XYY = assembly and date code.

### Package Information

#### SOP-8

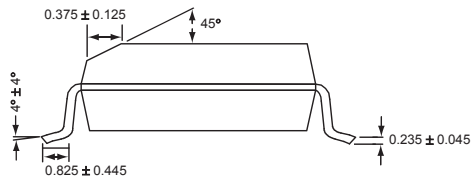
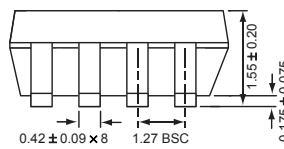
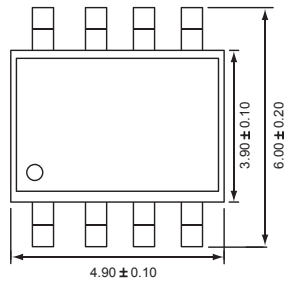

All dimensions in millimeters.

**TSSOP-8**

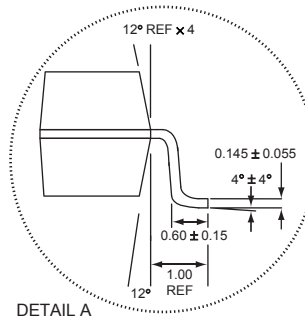
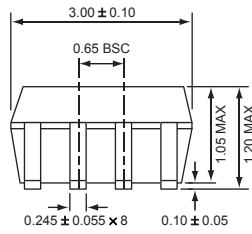
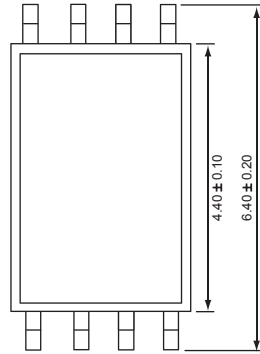

All dimensions in millimeters.

### MSOP-8

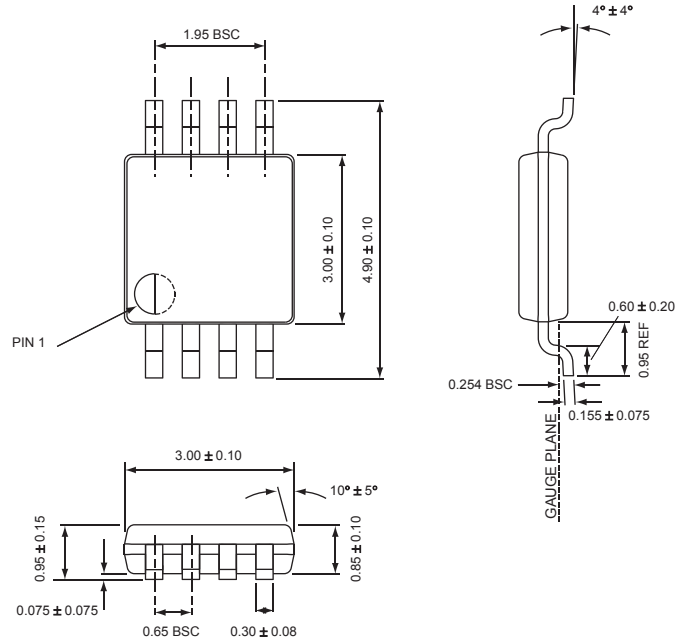

All dimensions in millimeters.

AnalogicTech cannot assume responsibility for use of any circuitry other than circuitry entirely embodied in an AnalogicTech product. No circuit patent licenses, copyrights, mask work rights, or other intellectual property rights are implied.

AnalogicTech reserves the right to make changes to their products or specifications or to discontinue any product or service without notice, and advise customers to obtain the latest version of relevant information to verify, before placing orders, that information being relied on is current and complete. All products are sold subject to the terms and conditions of sale supplied at the time of order acknowledgement, including those pertaining to warranty, patent infringement, and limitation of liability.

AnalogicTech warrants performance of its semiconductor products to the specifications applicable at the time of sale in accordance with AnalogicTech's standard warranty. Testing and other quality control techniques are utilized to the extent AnalogicTech deems necessary to support this warranty. Specific testing of all parameters of each device is not necessarily performed.

**Advanced Analogic Technologies, Inc.**  
830 E. Arques Avenue, Sunnyvale, CA 94085  
Phone (408) 737-4600  
Fax (408) 737-4611