

IR3637 EVALUATION BOARD USER GUIDE

DESCRIPTION

The IR3637 controller IC is designed to provide a low cost synchronous Buck regulator for on-board DC to DC applications in a small 8-pin SOIC. The output voltage can be precisely regulated using the internal 0.8V reference voltage for low voltage applications.

The IR3637 operates at a fixed internal 400KHz switching frequency to reduce the component size.

The device features under-voltage lockout for both input supplies, an external programmable soft-start function as well as output under-voltage detection that latches off the device when an output short is detected.

The reference board is designed for 1.8V output using +5V and +12V supplies. This will demonstrate the main features of IC.

This user guide contains the schematic and bill of materials, the design guidelines are described in data sheet.

SPECIFICATION DATA

$$V_c = 12V$$

$$V_{cc}=V_{in}=5V$$

$$V_{out}=1.8V$$

$$I_{out} = 7A$$

$$\text{Output Ripple} = 50mV$$

$$F_s = 400KHz$$

INPUT / OUTPUT CONNECTIONS

The following is the input / output connections:

Inputs:

JP1: Input (+5V) and GND

JU1: V_c

Outputs:

JP2: V_{out} (+1.8V) and GND

Other Connections:

J1: Scope connection for V_{out}

J2: Scope connection for Inductor Point

The connection points are shown in Figure1. Connect the power supply cables according to this figure, minimizing wire lengths to reduce losses in the wire. Test points J1 and J2 provide easy connection for oscilloscope voltage probe to monitor the inductor points and output voltage.

PACKAGE INFORMATION

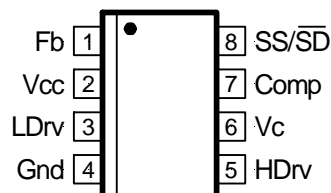

CONNECTION DIAGRAM

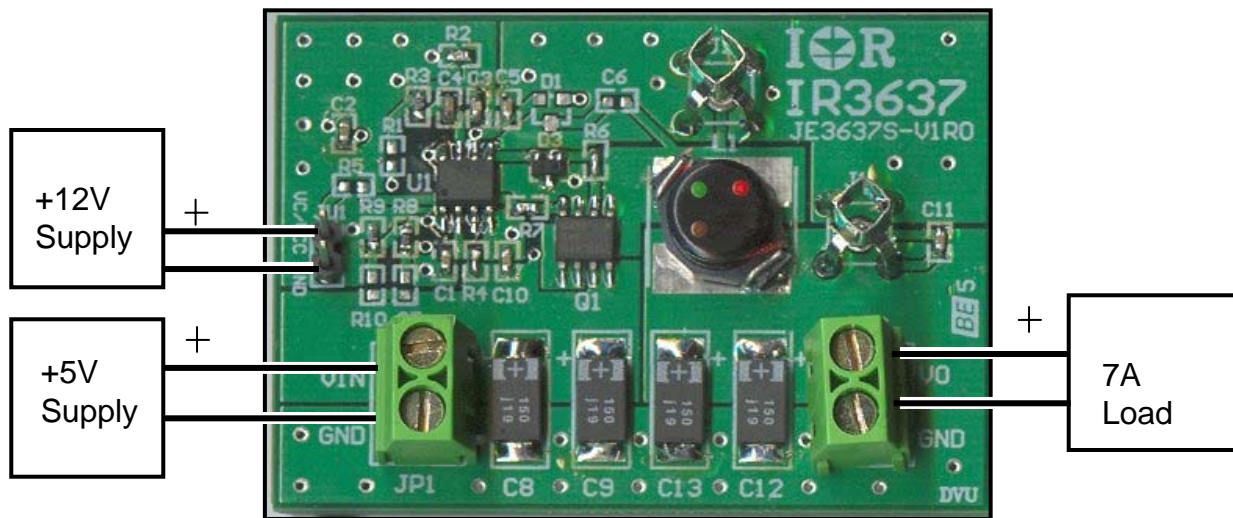

Figure 1 – Connection diagram of evaluation board for IR3637

LAYOUT

The top side (component) layer for IR3637 Eval board is shown in Figure 2. The input capacitors are all located close to the MOSFETs. All the decoupling capacitors, and feedback components are located close to IC. The feedback resistors are tied to the output voltage at the point of regulation.

The PCB is 4-layers board, one layer is dedicated to Power GND and the analog GND is kept separated from the PGND and it is connected at a single point.

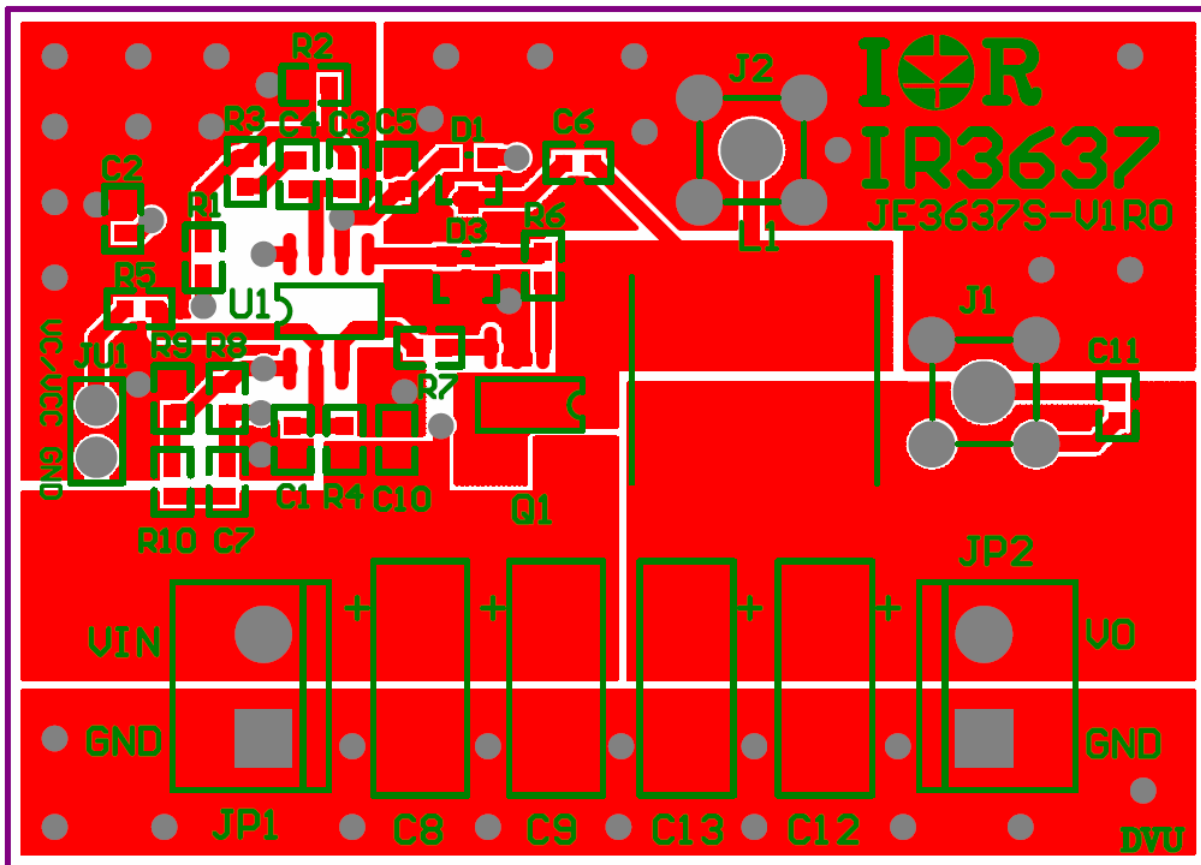

Figure 2 – Top layer of evaluation board for IR3637

SCHEMATIC

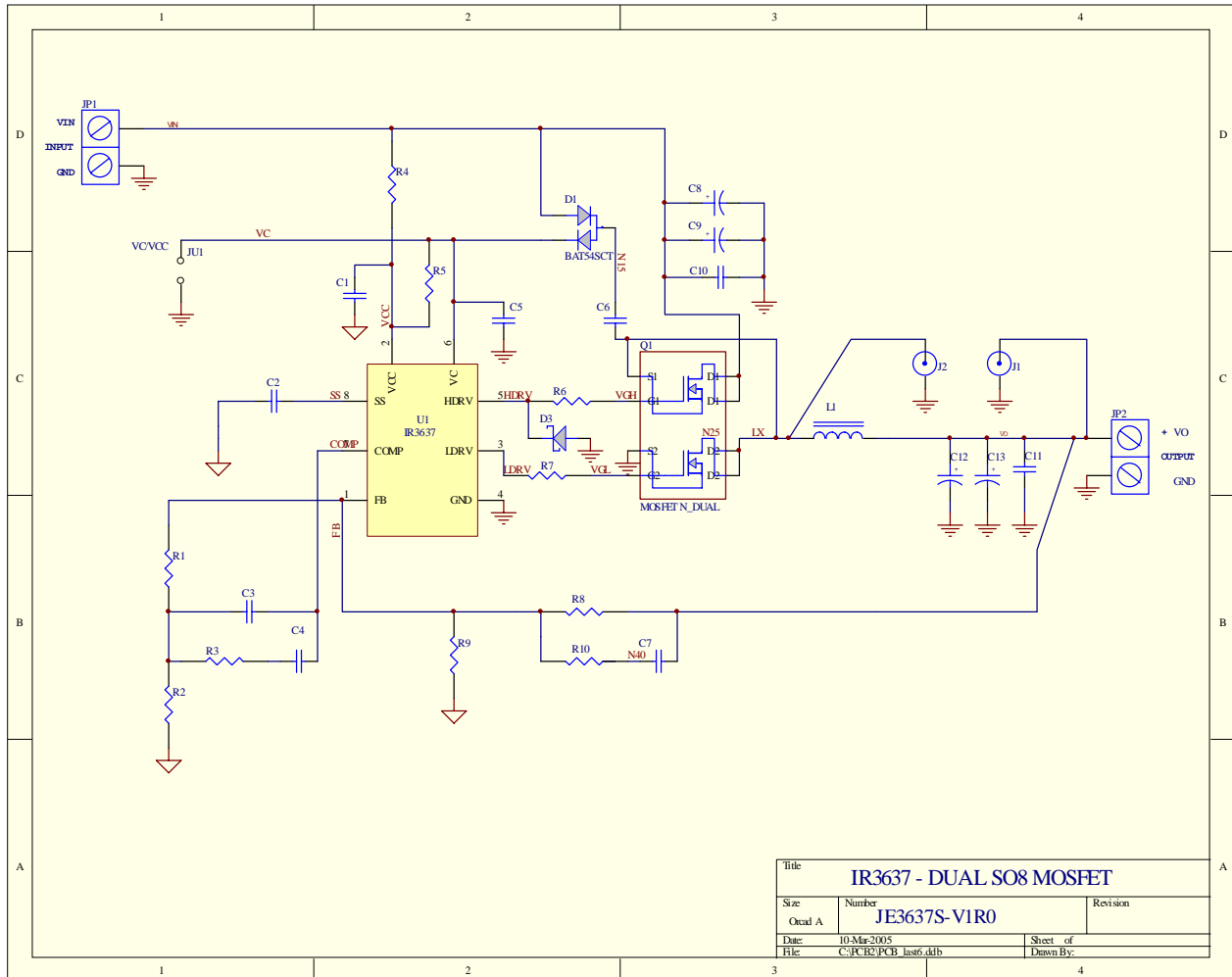

Figure 3 – Schematic of the evaluation board

BILL OF MATERIAL

Ref Desig	Description	Value	Qty	Part#	Manuf
Q1	Dual MOSFET	20V, 13.4mOhm	1	IRF8910	IR
U1	Controller	Synchronous PWM	1	IR3637	IR
D3	Diode	Fast Switching	1	BAT54A	IR
L1	Inductor	1.5uH, 8A, 10 mOhm	1	DO3316P-152	Coilcraft
C8,9,12,13	Cap, Poscap	150uF, 6.3V, 40mOhm	4	6TPC150M	Sanyo
C2,C5	Cap, Ceramic	0.1uF, X7R, 16V	2	ECJ-1VB1C104K	Panasonic
C1,10,11	Cap, Ceramic	1uF, X5R, 6.3V	3	ECJ-1VB0J105K	Panasonic
C3	Cap, Ceramic	22pF, NPO, 100V	1	ECJ-1VC2A220J	Panasonic
C4	Cap, Ceramic	1800pF, X7R, 50V	1	ECJ-1VB1H182K	Panasonic
R3	Resistor	16K, 1%	1	Any	
R8	Resistor	1.24K, 1%	1	Any	
R9	Resistor	1K, 1%	1	Any	
R2,4,6,7	Resistor	0 Ohm	4	Any	
R1,5,10	Resistor	Not Used	3		
C6,7	Capacitor	Not Used	2		
D1	Diode	Not Used	1		
J1,J2	Socket	Scope probe	2	131-5031-00	Tektronix
JP1,JP2	Terminal	Wire Connect	2	ED1973-ND	Digi-Key
JU1	Terminal	2-Pin Header	1	S1012-02-ND	Digi-Key

TYPICAL OPERATING WAVEFORMS

Test Conditions:

$V_{cc}=V_{in}=5V$, $V_c=12V$, $V_{out}=1.8V$, $I_{out}=0-7A$, $T_a=Room\ Temp$, No Air Flow.
Unless otherwise specified.

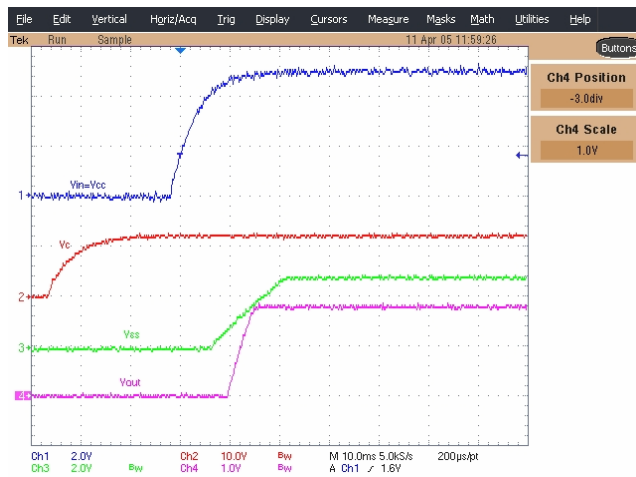

Figure 4 - Start up waveforms
Ch1: $V_{in}=V_{cc}$, Ch2: V_c , Ch3: V_{ss} , Ch4: V_{out}

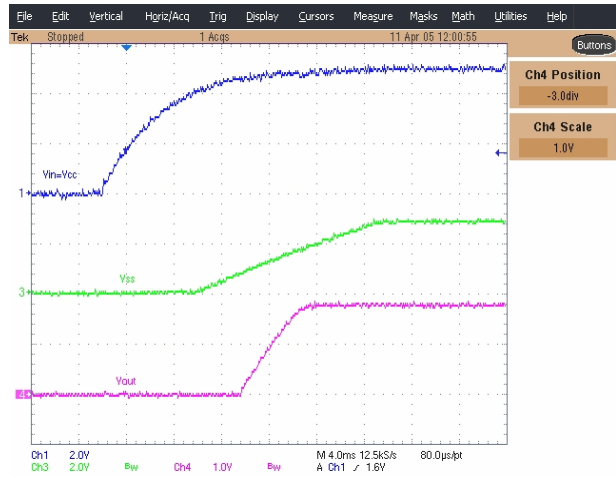

Figure 5 - Start up waveforms
Ch1: $V_{in}=V_{cc}$, Ch2: V_c , Ch3: V_{ss} , Ch4: V_{out}

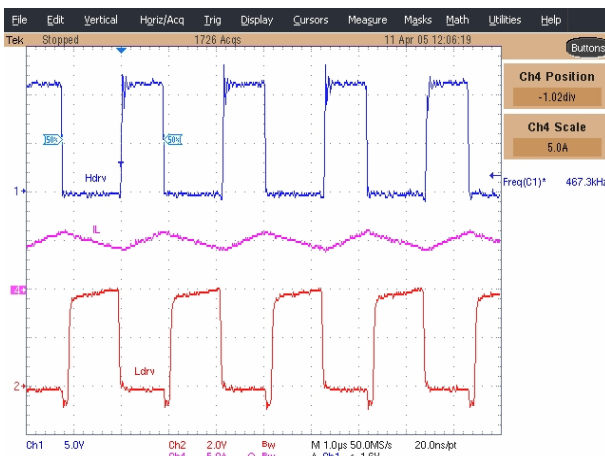

Figure 6 - Gates waveforms
Ch1: Hdrv, Ch2:Ldrv, Ch4:Inductor Current
 $I_{Load}=5A$

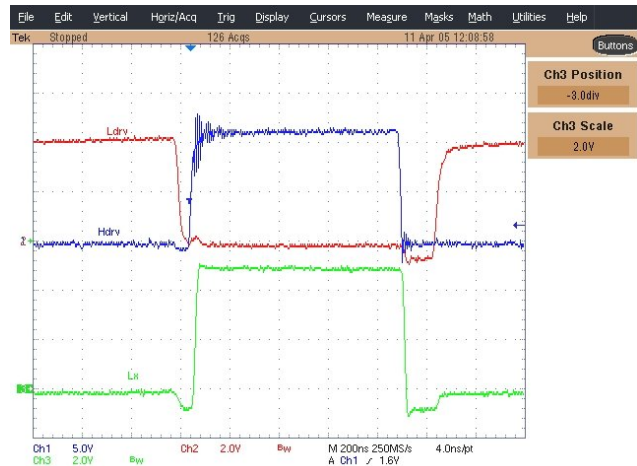

Figure 7 - Gates waveforms
Ch1: Hdrv, Ch2:Ldrv, Ch3:Inductor Point
 $I_{Load}=5A$

TYPICAL OPERATING WAVEFORMS

Test Conditions:

$V_{cc}=V_{in}=5V$, $V_c=12V$, $V_{out}=1.8V$, $I_{out}=0-7A$, $T_a=$ Room Temp, No Air Flow.

Unless otherwise specified.

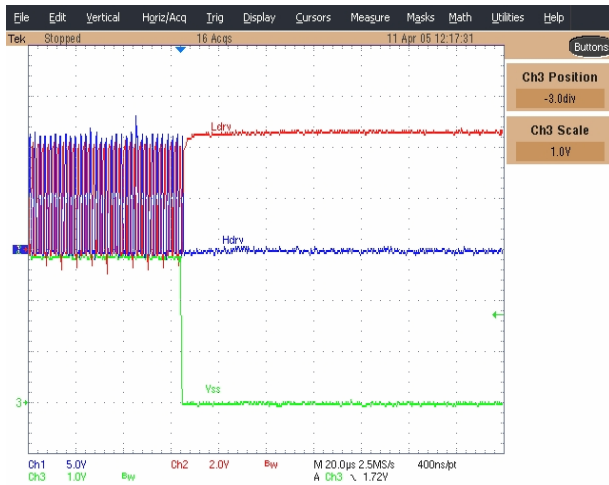

Figure 8 - Shutdown by shorting the SS pin
 Ch1: Hdrv, Ch2:Ldrv,, Ch3:SS
 $I_{Load}=5A$

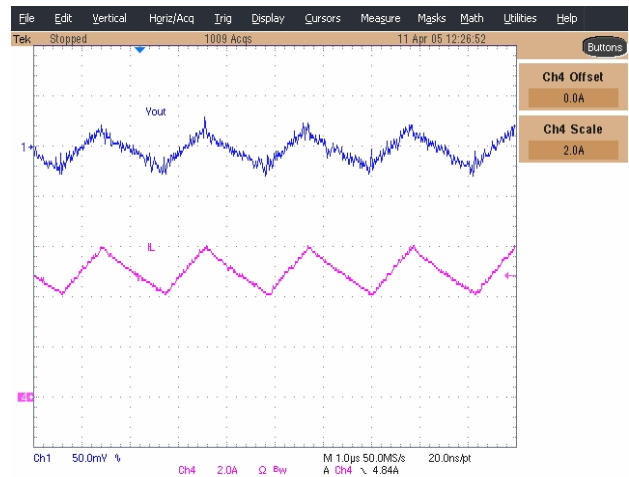

Figure 9 - Output Voltage Ripple
 Ch1: Vout, Ch4: Inductor Current
 $I_{Load}=5A$

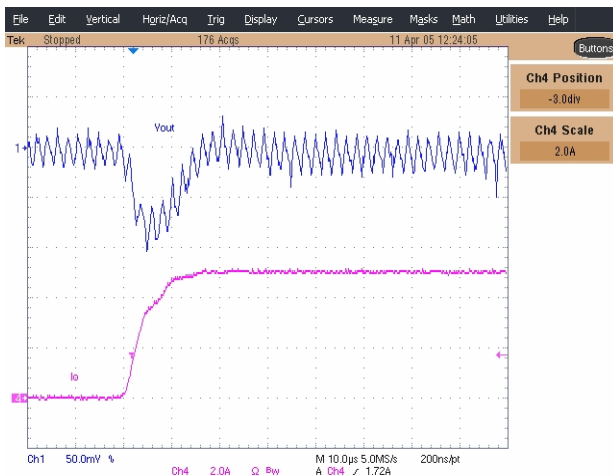

Figure 10 - Load Transient (0-5A)
 Ch1: Vout, Ch4: Step Load Current

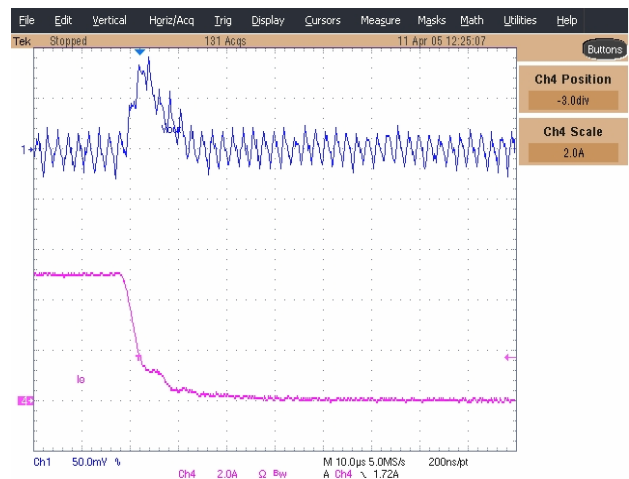

Figure 11 - Load Transient (5-0A)
 Ch1: Vout, Ch4: Step Load Current

TYPICAL PERFORMANMCE CURVES

Test Conditions:

$V_{cc}=V_{in}=5V$, $V_c=12V$, $V_{out}=1.8V$, $I_{out}=0-7A$, $T_a=Room\ Temp$, No Air Flow.

Unless otherwise specified.

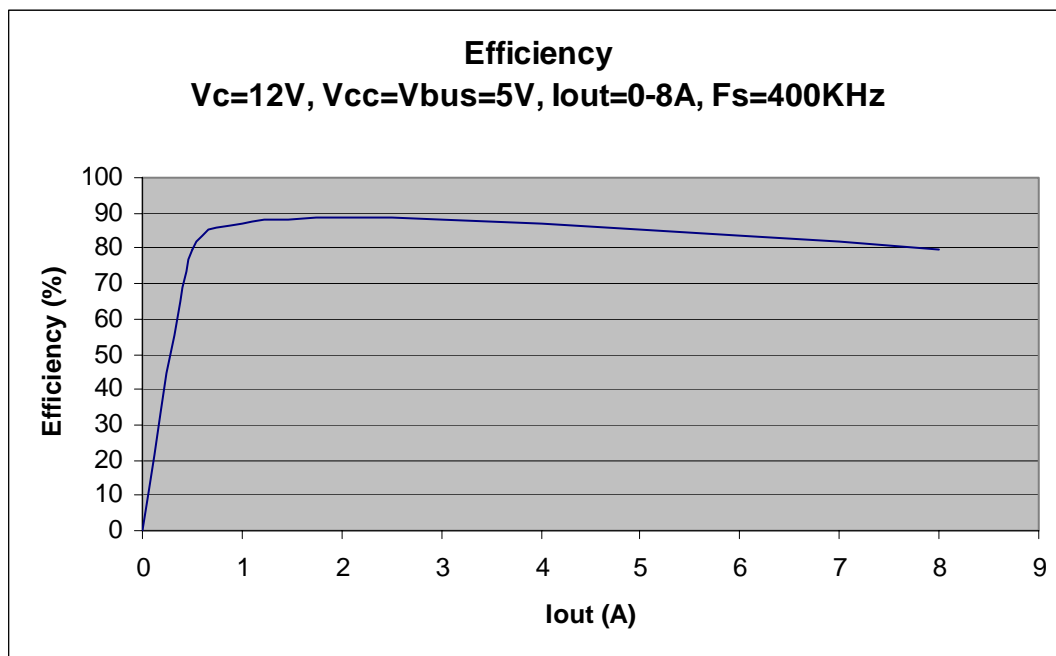

Figure 12 - Efficiency using IRF8910 Dual MOSFET

This product has been designed and qualified for the Industrial market.