

# KSM - 60 \*\* LM · KSM - 70 \*\* LM

The KSM - 60\*\*LM consist of a PIN Photodiode of high speed and a preamplifier IC in the package as an receiver for Infrared remote control systems

## FEATURES

- One mold small package
- 5 Volt supply voltage, low power consumption
- Shielded against electrical field disturbance
- High immunity against ambient light
- Easy interface with the main board
- TTL and CMOS compatibility

## APPLICATIONS

- TV, VTR, Acoustic Devices, Air Conditioners, Car Stereo Units, Computers, Interior controlling appliances, and all appliances that require remote controlling

## DIMENSIONS

(Unit : mm)

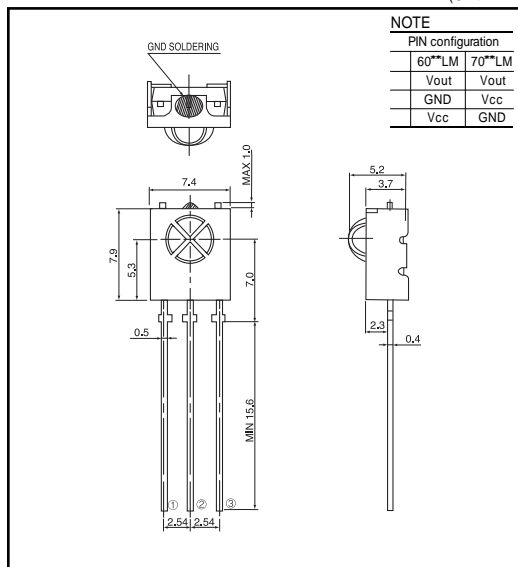

## MAXIMUM RATINGS

(Ta=25 Unless otherwise noted)

Parameter	Symbol	Rating	Unit
Supply Voltage	Vcc	5.5	V
Operating Temperature	Topr.	- 10 ~ +60	
Storage Temperature	Tstg.	- 20 ~ +75	
Soldering Temperature	Tsol.	260(Max 5 sec)	

## B.P.F CENTER FREQUENCY

Model NO.	B.P.F Center Frequency(kHz)
KSM - 1 LM	40.0
KSM - 2 LM	36.7
KSM - 3 LM	37.9
KSM - 4 LM	32.7
KSM - 5 LM	56.9

## ELECTRO-OPTICAL CHARACTERISTICS

(Ta=25 ), Vcc=5.0V

Parameter	Symbol	Conditions	Min.	Typ.	Max.	Unit.
Supply Voltage	Vcc		4.5	5.0	5.5	V
Current Consumption	Icc	Input Signal=0	-	1.2	2.5	mA
Peak Wavelength *1	p		-	940	-	nm
B.P.F Center Frequency	fo		-	37.9	-	kHz
Transmission Distance *1	L	0p	10	-	-	m
		±30p	7	-	-	m
H Level Output Voltage *1	V <sub>OH</sub>	30cm over the ray axis	4.5	5.0	-	V
L Level Output Voltage *1	V <sub>OL</sub>		-	0.1	0.5	V
H Level Output Pulse Width *1	T <sub>WH</sub>	Burst Wave=600 μs Period=1.2ns	500	600	700	μs
L Level Output Pulse Width *1	T <sub>WL</sub>		500	600	700	μs
Output Form			Active Low Output			

Note : \*1. It specifies the maximum distance between emitter and detector that the output waveform satisfies the standard under the conditions below against the standard transmitter

1) Measuring place : Indoor without extreme reflection of light

2) Ambient light source : Detecting surface illumination shall be irradiate 200 ± 50lx under ordinary white fluorescence lamp without high frequency lightning

3) Standard transmitter : Burst wave of standard transmitter shall be arranged to 50mVp - p under the measuring circuit

# Optic receiver modules

KSM - 60 \*\*\* LM · KSM - 70 \*\*\* LM

## MEASURING METHOD

### Output Pulse Width

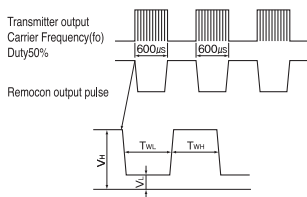

### Standard Transmitter

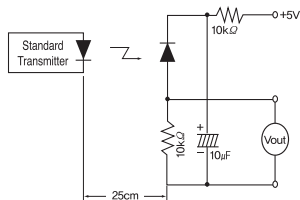

### Test Condition of Transmission Distance

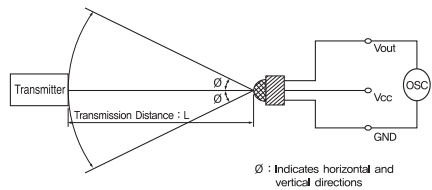

### Relative reception distance Vs. Frequency(37.9kHz)

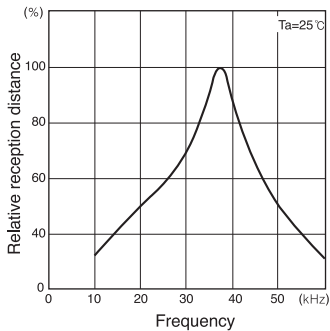

### Relative reception distance Vs. Power supply voltage

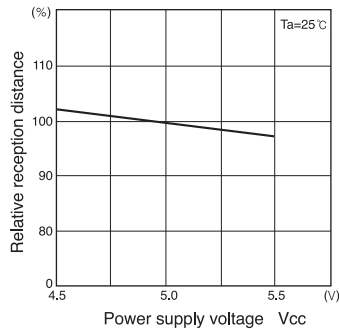

### Relative distance Vs. Supply current

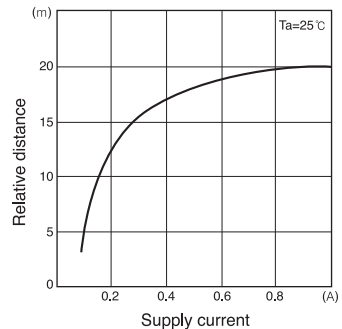

### Relative reception distance Vs. Ambient temperature

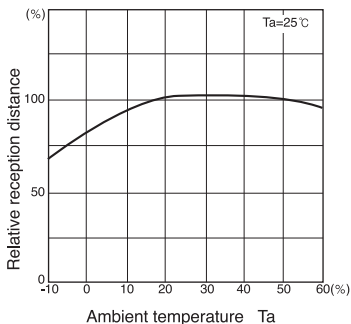

### Radiant pattern

