



NPN SILICON HIGH FREQUENCY TRANSISTOR

UPA814T

FEATURES

- **SMALL PACKAGE STYLE:**
2 NE688 Die in a 2 mm x 1.25 mm package
- **LOW NOISE FIGURE:**
NF = 1.5 dB TYP at 2 GHz
- **HIGH GAIN BANDWIDTH:** $f_T = 9$ GHz
- **HIGH COLLECTOR CURRENT:** 100 mA

DESCRIPTION

NEC's UPA814T is two NPN high frequency silicon epitaxial transistors encapsulated in an ultra small 6 pin SMT package. Each transistor is independently mounted and easily configured for either dual transistor or cascode operation. The high f_T , low voltage bias and small size make this device suited for various hand-held wireless applications.

ABSOLUTE MAXIMUM RATINGS¹ ($T_A = 25^\circ\text{C}$)

| SYMBOLS | PARAMETERS | UNITS | RATINGS |
|------------------|---|----------|-------------|
| V _{CB0} | Collector to Base Voltage | V | 9 |
| V _{CEO} | Collector to Emitter Voltage | V | 6 |
| V _{EBO} | Emitter to Base Voltage | V | 2 |
| I _c | Collector Current | mA | 100 |
| P _T | Total Power Dissipation 1 Die 2 Die | mW mW | 110 200 |
| T _J | Junction Temperature | °C | 150 |
| T _{STG} | Storage Temperature | °C | -65 to +150 |

Note: 1. Operation in excess of any one of these parameters may result in permanent damage.

ELECTRICAL CHARACTERISTICS ($T_A = 25^\circ\text{C}$)

| PART NUMBER PACKAGE OUTLINE | | | UPA814T S06 | | |
|------------------------------------|--|-------|----------------|------|------|
| SYMBOLS | PARAMETERS AND CONDITIONS | UNITS | MIN | TYP | MAX |
| I _{CBO} | Collector Cutoff Current at V _{CB} = 5V, I _E = 0 | μA | | | 0.1 |
| I _{EBO} | Emitter Cutoff Current at V _{EB} = 1V, I _C = 0 | μA | | | 0.1 |
| h _{FE} ¹ | Forward Current Gain at V _{CE} = 1V, I _C = 3 mA | | 80 | 110 | 160 |
| f _T | Gain Bandwidth at V _{CE} = 3V, I _C = 20 mA, f = 2 GHz | GHz | | 9.0 | |
| C _{re} ² | Feedback Capacitance at V _{CB} = 1V, I _E = 0, f = 1 MHz | pF | | 0.75 | 0.85 |
| S _{21E} ² | Insertion Power Gain at V _{CE} = 3V, I _C = 20 mA, f = 2 GHz | dB | | 6.5 | |
| NF | Noise Figure at V _{CE} = 3V, I _C = 7 mA, f = 2 GHz | dB | | 1.5 | |
| h _{FE1} /h _{FE2} | h _{FE} Ratio: h _{FE1} = Smaller Value of Q ₁ , or Q ₂ h _{FE2} = Larger Value of Q ₁ or Q ₂ | | 0.85 | | |

Notes: 1. Pulsed measurement, pulse width ≤ 350 μs, duty cycle ≤ 2 %.

2. The emitter terminal should be connected to the ground terminal of the 3 terminal capacitance bridge.

For Tape and Reel version use part number UPA814T-T1, 3K per reel.

OUTLINE DIMENSIONS (Units in mm)

PACKAGE OUTLINE S06

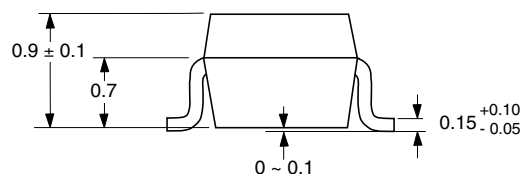
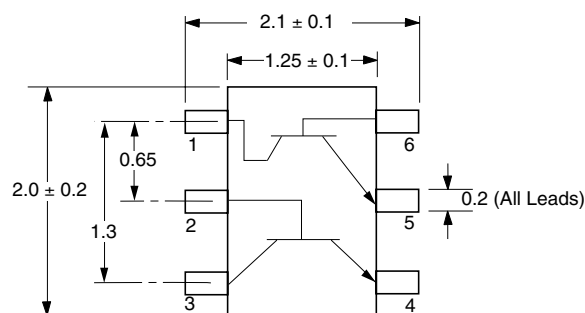

PIN OUT

1. Collector Transistor 1
2. Base Transistor 2
3. Collector Transistor 2
4. Emitter Transistor 2
5. Emitter Transistor 1
6. Base Transistor 1

Note:

Pin 3 is identified with a circle on the bottom of the package.

TYPICAL PERFORMANCE CURVES (T_A = 25°C)

TOTAL POWER DISSIPATION vs. AMBIENT TEMPERATURE

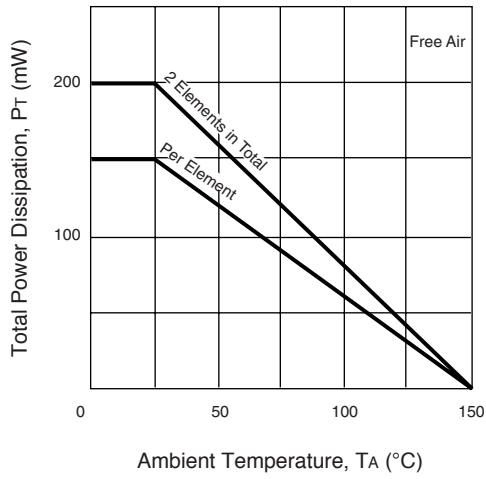

COLLECTOR CURRENT vs. BASE TO EMITTER VOLTAGE

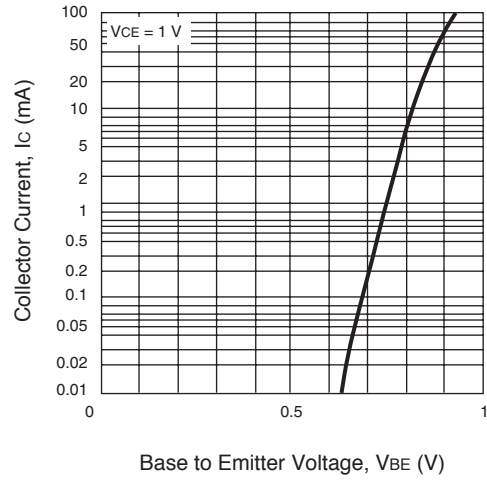

COLLECTOR CURRENT vs. COLLECTOR TO EMITTER VOLTAGE

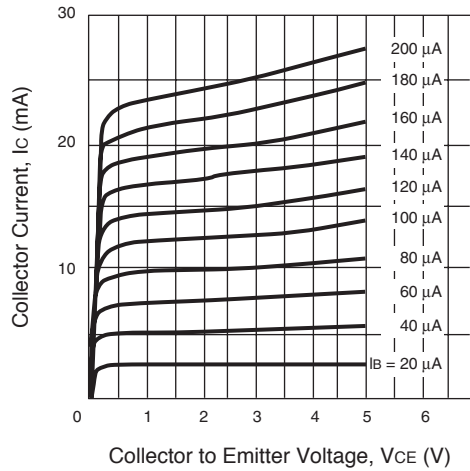

DC CURRENT GAIN vs. COLLECTOR CURRENT

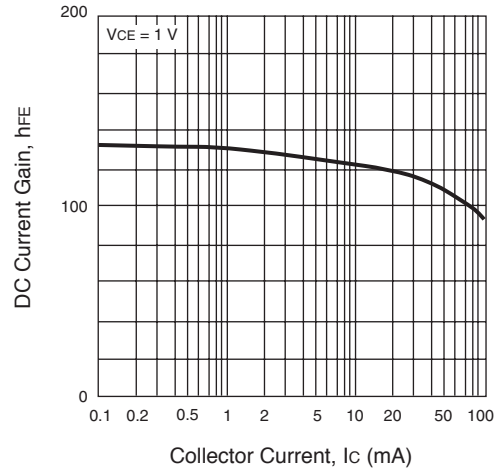

GAIN BANDWIDTH PRODUCT vs. COLLECTOR CURRENT

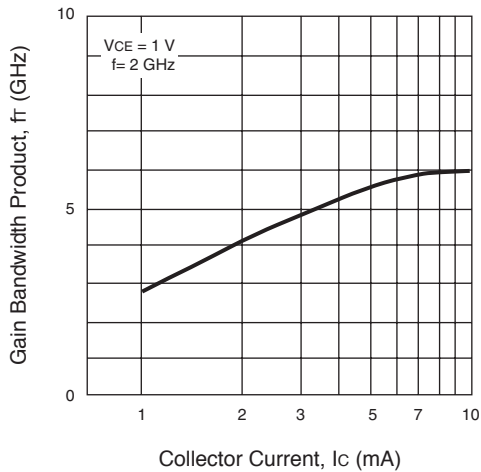

INSERTION POWER GAIN vs. COLLECTOR CURRENT

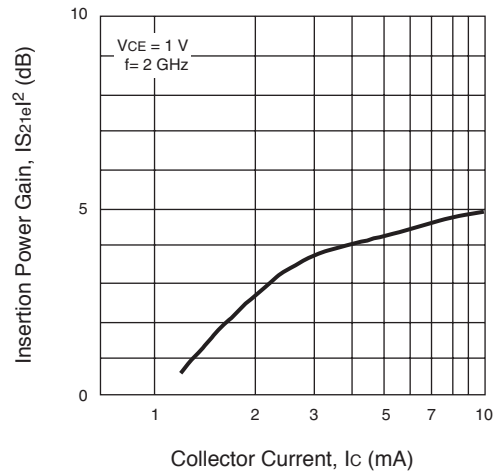

TYPICAL PERFORMANCE CURVES ($T_A = 25^\circ\text{C}$)

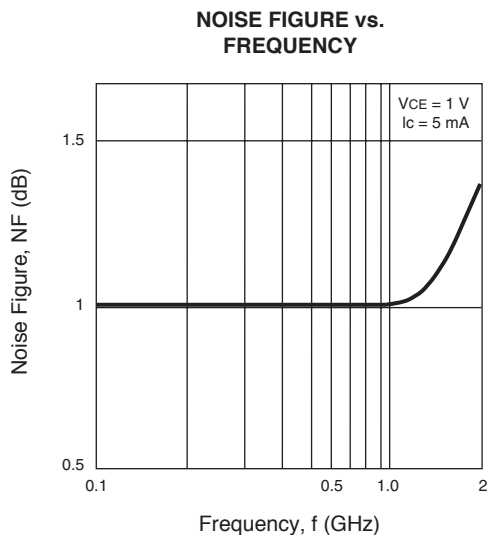
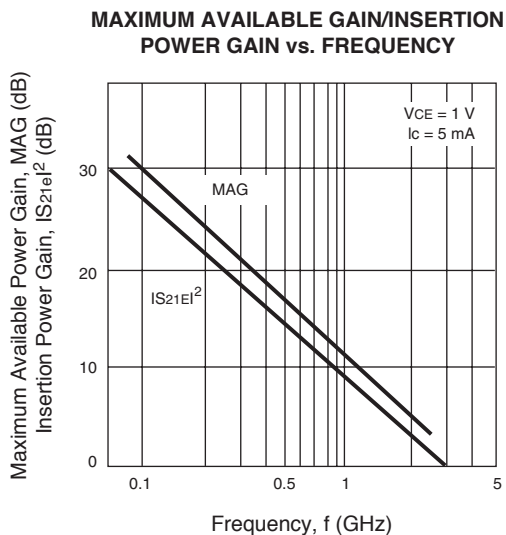
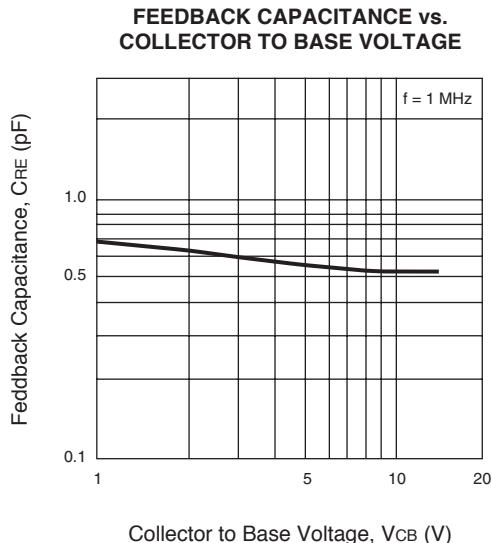
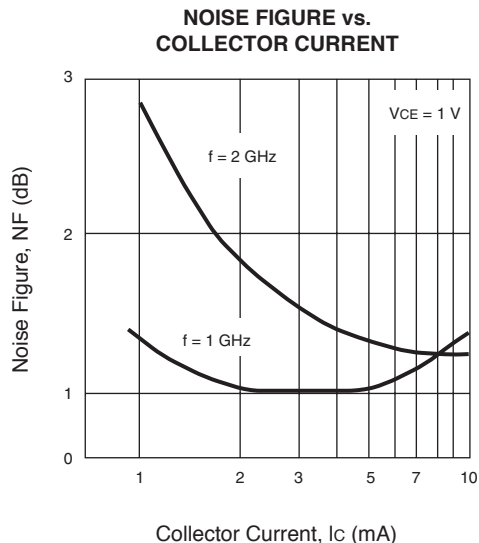

ORDERING INFORMATION

| PART NUMBER | QUANTITY | PACKAGING |
|--------------|----------|-------------|
| UPA814T-T1-A | 3000 | Tape & Reel |

Life Support Applications

These NEC products are not intended for use in life support devices, appliances, or systems where the malfunction of these products can reasonably be expected to result in personal injury. The customers of CEL using or selling these products for use in such applications do so at their own risk and agree to fully indemnify CEL for all damages resulting from such improper use or sale.

EXCLUSIVE NORTH AMERICAN AGENT FOR **NEC** RF, MICROWAVE & OPTOELECTRONIC SEMICONDUCTORS

CEL CALIFORNIA EASTERN LABORATORIES • Headquarters • 4590 Patrick Henry Drive • Santa Clara, CA 95054-1817 • (408) 988-3500 • Telex 34-6393 • FAX (408) 988-0279
 24-Hour Fax-On-Demand: 800-390-3232 (U.S. and Canada only) • Internet: <http://WWW.CEL.COM>

DATA SUBJECT TO CHANGE WITHOUT NOTICE

Subject: Compliance with EU Directives

CEL certifies, to its knowledge, that semiconductor and laser products detailed below are compliant with the requirements of European Union (EU) Directive 2002/95/EC Restriction on Use of Hazardous Substances in electrical and electronic equipment (RoHS) and the requirements of EU Directive 2003/11/EC Restriction on Penta and Octa BDE.

CEL Pb-free products have the same base part number with a suffix added. The suffix –A indicates that the device is Pb-free. The –AZ suffix is used to designate devices containing Pb which are exempted from the requirement of RoHS directive (*). In all cases the devices have Pb-free terminals. All devices with these suffixes meet the requirements of the RoHS directive.

This status is based on CEL’s understanding of the EU Directives and knowledge of the materials that go into its products as of the date of disclosure of this information.

| Restricted Substance per RoHS | Concentration Limit per RoHS (values are not yet fixed) | Concentration contained in CEL devices | |
|-------------------------------|---|--|-----|
| | | -A | -AZ |
| Lead (Pb) | < 1000 PPM | Not Detected | (*) |
| Mercury | < 1000 PPM | Not Detected | |
| Cadmium | < 100 PPM | Not Detected | |
| Hexavalent Chromium | < 1000 PPM | Not Detected | |
| PBB | < 1000 PPM | Not Detected | |
| PBDE | < 1000 PPM | Not Detected | |

If you should have any additional questions regarding our devices and compliance to environmental standards, please do not hesitate to contact your local representative.

Important Information and Disclaimer: Information provided by CEL on its website or in other communications concerning the substance content of its products represents knowledge and belief as of the date that it is provided. CEL bases its knowledge and belief on information provided by third parties and makes no representation or warranty as to the accuracy of such information. Efforts are underway to better integrate information from third parties. CEL has taken and continues to take reasonable steps to provide representative and accurate information but may not have conducted destructive testing or chemical analysis on incoming materials and chemicals. CEL and CEL suppliers consider certain information to be proprietary, and thus CAS numbers and other limited information may not be available for release.

In no event shall CEL’s liability arising out of such information exceed the total purchase price of the CEL part(s) at issue sold by CEL to customer on an annual basis.

See CEL Terms and Conditions for additional clarification of warranties and liability.