



# COLOR MONITOR

PN17LT/LO

# *SERVICE* Manual

## COLOR MONITOR

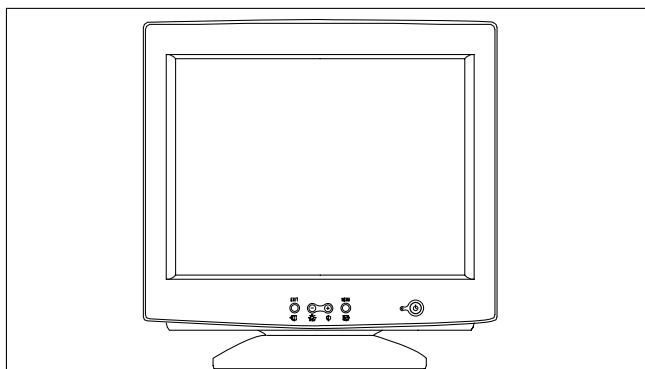

PN17LT

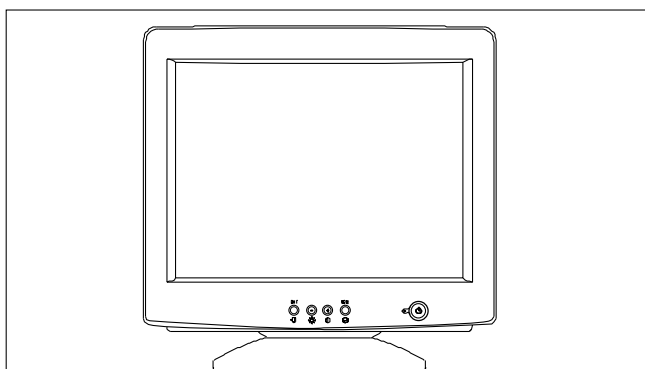

PN17LO

## CONTENTS

1. Precautions
2. Product Specifications
3. Disassembly & Reassembly
4. Alignment & Adjustments
5. Troubleshooting
6. Exploded View & Parts List
7. Electrical Parts List
8. Block Diagram
9. Wiring Diagram
10. Schematic Diagrams



**Samsung Electronics Co.,Ltd.**

416, Maetan-3Dong, Paldal-Gu, Suwon City, Kyungki-Do, Korea.

TEL : 1588-3366

Printed in Korea

P/N : BH68-00393B-00

<http://www.samsungmonitor.com> (SyncMaster Worldwide)

<http://www.samsung-monitor.com> (SyncMaster USA)

<http://www.samtron.com> (SAMTRON Worldwide)

<http://www.sec.co.kr/monitor> (Korea)

# 1 Precautions

## 1-1 Safety Precautions

### WARNINGS

1. For continued safety, do not attempt to modify the circuit board.
2. Disconnect the AC power before servicing.
3. When the chassis is operating, semiconductor heatsinks are potential shock hazards.

### 1-1-1 Servicing the High Voltage and CRT :

**WARNING:** A high voltage adjusted to the wrong value may cause excessive X-ray emissions.

1. When servicing the high voltage system, remove the static charge by connecting a 10 kohm resistor in series with an insulated wire (such as a test probe) between the chassis and the anode lead.
2. When troubleshooting a monitor with excessively HV, avoid being unnecessarily close to the monitor. Do not operate the monitor for longer than is necessary to locate the cause of excessive voltage.
3. High voltage should always be kept at the rated value, no higher. Only when high voltage is excessive are X-rays capable of penetrating the shell of the CRT, including the lead in glass material. Operation at high voltages may also cause failure of the CRT or high voltage circuitry.
4. When the HV regulator is operating properly, there is no possibility of an X-ray problem. Make sure the HV does not exceed its specified value and that it is regulating correctly.
5. The CRT is especially designed to prohibit X-ray emissions. To ensure continued X-ray protection, replace the CRT only with one that is the same or equivalent type as the original.
6. Handle the CRT only when wearing shatterproof goggles and after completely discharging the high voltage anode.
7. Do not lift the CRT by the neck.

### 1-1-2 Fire and Shock Hazard :

Before returning the monitor to the user, perform the following safety checks:

1. Inspect each lead dress to make certain that the leads are not pinched or that hardware is not lodged between the chassis and other metal parts in the monitor.
2. Inspect all protective devices such as nonmetallic control knobs, insulating materials, cabinet backs, adjustment and compartment covers or shields, isolation resistor-capacitor networks, mechanical insulators, etc.

3. Leakage Current Hot Check (Figure 1-1):  
**WARNING: Do not use an isolation transformer during this test.**

Use a leakage current tester or a metering system that complies with American National Standards Institute (ANSI C101.1, *Leakage Current for Appliances*), and Underwriters Laboratories (UL Publication UL1410, 59.7).

4. With the unit completely reassembled, plug the AC line cord directly into a 120V AC outlet. With the unit's AC switch first in the ON position and then OFF, measure the current between a known earth ground (metal water pipe, conduit, etc.) and all exposed metal parts, including: metal cabinets, screwheads and control shafts. The current measured should not exceed 0.5 milliamp. Reverse the power-plug prongs in the AC outlet and repeat the test.

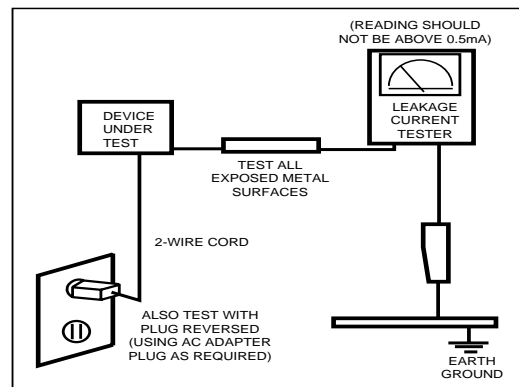



Figure 1-1. Leakage Current Test Circuit

### 1-1-3 Product Safety Notices

Some electrical and mechanical parts have special safety-related characteristics which are often not evident from visual inspection. The protection they give may not be obtained by replacing them with components rated for higher voltage, wattage, etc. Parts that have special safety characteristics are identified by  on schematics and parts lists. A substitute replacement that does not have the same safety characteristics as the recommended replacement part might create shock, fire and / or other hazards. Product safety is under review continuously and new instructions are issued whenever appropriate.

Components identified by  on schematics and parts lists must be sealed by a soldering iron after replacement and adjustment.

## 1-2 Servicing Precautions

---

**WARNING1:** First read the “Safety Precautions” section of this manual. If unforeseen circumstances create conflict between the servicing precautions and safety precautions, always follow the safety precautions.

**WARNING2:** A high voltage adjusted to the wrong value may cause excessive X-ray emissions.

**WARNING3:** An electrolytic capacitor installed with the wrong polarity might explode.

1. Servicing precautions are printed on the cabinet, and should be followed closely.
2. Always unplug the unit’s AC power cord from the AC power source before attempting to: (a) remove or reinstall any component or assembly, (b) disconnect PCB plugs or connectors, (c) connect all test components in parallel with an electrolytic capacitor.
3. Some components are raised above the printed circuit board for safety. An insulation tube or tape is sometimes used. The internal wiring is sometimes clamped to prevent contact with thermally hot components. Reinstall all such elements to their original position.
4. After servicing, always check that the screws, components and wiring have been correctly reinstalled. Make sure that the area around the serviced part has not been damaged.
5. Check the insulation between the blades of the AC plug and accessible conductive parts (examples: metal panels, input terminals and earphone jacks).
6. Insulation Checking Procedure: Disconnect the power cord from the AC source and turn the power switch ON. Connect an insulation resistance meter (500 V) to the blades of the AC plug.  
The insulation resistance between each blade of the AC plug and accessible conductive parts (see above) should be greater than 1 megohm.
7. Never defeat any of the +B voltage interlocks. Do not apply AC power to the unit (or any of its assemblies) unless all solid-state heat sinks are correctly installed.
8. Always connect a test instrument’s ground lead to the instrument chassis ground *before* connecting the positive lead; always remove the instrument’s ground lead last.

## 1-3 Electrostatically Sensitive Devices (ESD) Precautions

---

Some semiconductor (solid state) devices can be easily damaged by static electricity. Such components are commonly called Electrostatically Sensitive Devices (ESD). Examples of typical ESD devices are integrated circuits and some field-effect transistors. The following techniques will reduce the incidence of component damage caused by static electricity.

1. Immediately before handling any semiconductor components or assemblies, drain the electrostatic charge from your body by touching a known earth ground. Alternatively, wear a discharging wrist-strap device. To avoid a shock hazard, be sure to remove the wrist strap before applying power to the monitor.
2. After removing an ESD-equipped assembly, place it on a conductive surface such as aluminum foil to prevent accumulation of an electrostatic charge.
3. Do not use freon-propelled chemicals. These can generate electrical charges sufficient to damage ESDs.
4. Use only a grounded-tip soldering iron to solder or desolder ESDs.
5. Use only an anti-static solder removal device. Some solder removal devices not classified as “anti-static” can generate electrical charges sufficient to damage ESDs.
6. Do not remove a replacement ESD from its protective package until you are ready to install it. Most replacement ESDs are packaged with leads that are electrically shorted together by conductive foam, aluminum foil or other conductive materials.
7. Immediately before removing the protective material from the leads of a replacement ESD, touch the protective material to the chassis or circuit assembly into which the device will be installed.  
**Caution:** Be sure no power is applied to the chassis or circuit and observe all other safety precautions.
8. Minimize body motions when handling unpackaged replacement ESDs. Motions such as brushing clothes together, or lifting your foot from a carpeted floor can generate enough static electricity to damage an ESD.
9.  Indicates ESDs on the Schematic Diagram in this manual.

## 2 Product Specifications

### 2-1 Specifications

Item	Description
Picture Tube:	17-Inch (43 cm): 16-inch (40.6 cm) viewable, Full-square flat-face tube, 90° Deflection, Semi- tint, Invar shadow mask, Anti-static silica coating, 0.26 mm Dot pitch
Scanning Frequency	Horizontal : 30 kHz ~ 70 kHz (Automatic)      Vertical : 50 Hz ~ 160 Hz (Automatic)
Display Colors	Unlimited colors
Maximum Resolution	Horizontal : 1280 Dots      Vertical : 1024 Lines
Input Video Signal	Analog, 0.7 Vp-p positive at 75 $\Omega$ , internally terminated
Input Sync Signal	Separate Sync: TTL level positive/negative
Maximum Pixel Clock rate	110 MHz
Active Display	Horizontal : 312 mm $\pm$ 4 mm,      Vertical : 234 mm $\pm$ 4 mm
Input Voltage	AC 90 to 264 Volts, 60 Hz / 50 Hz $\pm$ 3 Hz
Power Consumption	110 Watt (max)
Dimensions (W x D x H) (with base)	15.66 x 16.22 x 15.75 Inches (398 x 412 x 400 mm)
Weight (Net/Gross)	33.1 lbs (15.0 kg) / 38.6 lbs (17.5 kg)
Environmental Considerations	Operating Temperature : 32°F ~ 104°F (0°C ~ 40°C) Humidity : 10 % ~ 80 % Storage Temperature : -4°F ~ 113°F (-20°C ~ 45°C) Humidity : 5 % ~ 95 %
<ul style="list-style-type: none"> <li>• Above models comply with SWEDAC MPR II / TCO99 recommendations for reduced electromagnetic fields.</li> <li>• Designs and specifications are subject to change without prior notice.</li> </ul>	

## 2-2 Pin Assignments

Pin No. \ Sync Type	Separate	Macintosh
1	Red	GND-R
2	Green	Red
3	Blue	H/V Sync.
4	N-C	Sense 0
5	GND (DDC)	Green
6	GND-R	GND-G
7	GND-G	Sense 1
8	GND-B	Reserved
9	Reserved (N-C)	Blue
10	GND-Sync./Self-raster	Sense 2
11	N-C	GND
12	DDC Data	V-Sync.
13	H-Sync.	GND-B
14	V-Sync.	GND
15	DDC Clock	H-Sync.

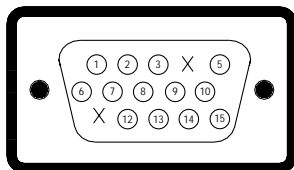

Figure 2-1. Male Type

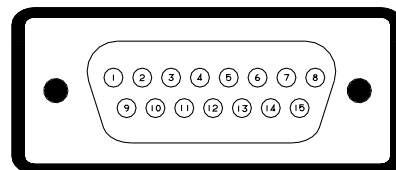

Figure 2-2. Male Type

## 2-3 Timing Chart

This section of the service manual describes the timing that the computer industry recognizes as standard for computer-generated video signals.

Table 2-1. Timing Chart

Mode Timing	IBM		VESA					
	VGA2/70 Hz 720 x 400	VGA3/60 Hz 640 x 480	640/75 Hz 640 x 480	640/85 Hz 640 x 480	800/75 Hz 800 x 600	800/85 Hz 800 x 600	1024/75 Hz 1024 x 768	1024/85 Hz 1024 x 768
fH (kHz)	31.469	31.469	37.500	43.269	46.875	53.674	60.023	68.677
A $\mu$ sec	31.777	31.778	26.667	23.111	21.333	18.631	16.660	14.561
B $\mu$ sec	3.813	3.813	2.032	1.556	1.616	1.138	1.219	1.016
C $\mu$ sec	1.907	1.907	3.810	2.222	3.232	2.702	2.235	2.201
D $\mu$ sec	25.422	25.422	20.317	17.778	16.162	14.222	13.003	10.836
E $\mu$ sec	0.636	0.636	0.508	1.556	0.323	0.569	0.203	0.508
fV (Hz)	70.087	59.940	75.000	85.008	75.000	85.061	75.029	84.997
O msec	14.268	16.683	13.333	11.764	13.333	11.756	13.328	11.765
P msec	0.064	0.064	0.080	0.671	0.064	0.056	0.050	0.044
Q msec	1.080	1.048	0.427	0.578	0.448	0.503	0.466	0.524
R msec	12.711	15.253	12.800	11.093	12.800	11.179	12.795	11.183
S msec	0.413	0.318	0.027	0.023	0.021	0.019	0.017	0.015
Clock Frequency (MHz)	28.322	25.175	31.500	36.000	49.500	56.250	78.750	94.500
Polarity H.Sync	Negative	Negative	Negative	Negative	Positive	Positive	Positive	Positive
V.Sync	Positive	Negative	Negative	Negative	Positive	Positive	Positive	Positive
Remark	Separate	Separate	Separate	Separate	Separate	Separate	Separate	Separate

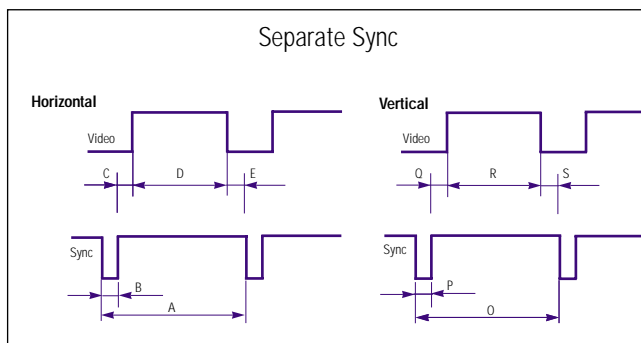

A : Line time total	B : Horizontal sync width	O : Frame time total	P : Vertical sync width
C : Back porch	D : Active time	Q : Back porch	R : Active time
E : Front porch		S : Front porch	

## Memo



---

## 3 Disassembly and Reassembly

---

This section of the service manual describes the disassembly and reassembly procedures for the PN17LT/LO monitors.

**WARNING:** This monitor contains electrostatically sensitive devices. Use with caution when handling these components.

### 3-1 Disassembly

---

- Cautions:**
1. Disconnect the monitor from the power source before disassembly.
  2. To remove the Rear Cover, you must use the special opening jig tool.

#### 3-1-1 Before making Disassembly

1. Disconnect or power cord from the monitor.
2. With a pad beneath it, stand the monitor on its front with the screen facing downward and the base close to you.

#### 3-1-2 Cabinet Disassembly

1. Remove the Stand from the monitor.  
(Refer to Stand manual)
2. Remove 2 screws on the Rear cover.



Figure 1

3. Incline the monitor by lifting the rear of the monitor.



Figure 2

4. Push the Opening jig each groove along the top of the monitor till it makes a "tak" sound. (2 grooves : Left and Right, Make sure each snap is disengaged.)



Figure 3

5. Pull the Rear Cover up off the monitor.



Figure 4

6. Remove the Shield.(TCO 99)

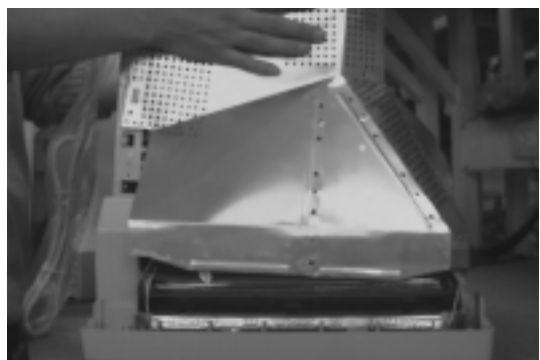

Figure 5

### 3 Disassembly and Reassembly

- Using pinch-nose pliers or ling-nose pliers, carefully disconnect the Anode Cap from the CRT.

**Warning:** Do not touch the Anode contact on the CRT (High Voltage may remain).

#### 3-1-3 Removing the CRT Socket PCB

- Complete all previous steps.
- Lift up the Video Spring and remove the CRT Socket PCB from the CRT.

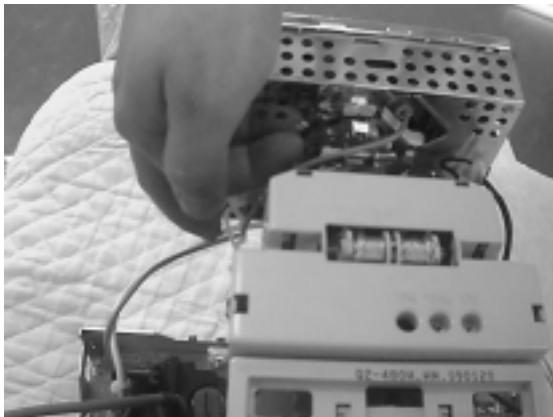

Figure 6

- Disconnect all connectors on the CRT Socket PCB.
- Using a solder iron, disconnect Ground (GND) on the back of the Video Shield and remove the Shield Cap.
- Remove the screw on the front of the Shield Socket.
- Desolder the 4 tabs on the CRT Socket PCB and remove Shield.
- Place the Video PCB on a flat, level surface that is protected from static electricity.

#### 3-1-4 Removing the Main PCB

- Complete all previous steps.
- Disconnect the Degaussing Coil at GT601 and GT602 on the Main PCB.
- Disconnect all easily accessible ground wires on the PCB and Bottom Chassis.
- Disconnect the DY connector at the CN303 connector on the Main .
- Using the jig, release the snaps (2) connecting the Front Cover and the PCB then lift up the Bottom to separate the two Shield.

## 3-2 Reassembly

---

Reassembly procedures are in the reverse order of Disassembly procedures.

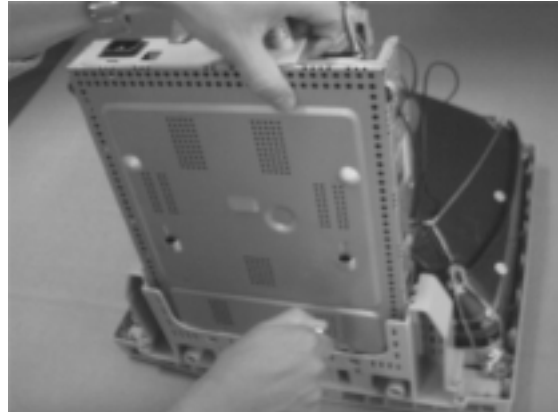

Figure 7

- Disconnect the Tilt connector at the CN304 connector on the Main PCB.
- Disconnect the Sub PCB connector at the CN203 connector on the Main PCB.
- Remove the screws on the back and along each side of the Bottom Chassis.
- Carefully lift the Main PCB Ass'y and remove the remaining ground wires.
- Place the Main PCB Ass'y on a flat, level surface that is protected from static electricity.

#### 3-1-5 CRT Ass'y Disassembly

- Complete all previous steps.
- Straighten the Degaussing Coil Assembly coated metal ties and lift the Coil Ass'y from the CRT.
- Remove the four corner screws and lift the CRT up and away from the Front Cover Assembly and place it on a padded surface.

**Caution:** Do not lift the CRT by the neck.

If you will be returning this CRT to the monitor, be sure to place the CRT face downward on a protective pad.

---

## 4 Alignment and Adjustments

---

This section of the service manual explains how to make permanent adjustments to the monitor. Directions are given for adjustments using the monitor Interface Board Ver. 2.0 and software (Softjig).

### 4-1 Adjustment Conditions

---

**Caution:** Changes made without the Softjig are saved only to the user mode settings. As such, the settings are not permanently stored and may be inadvertently deleted by the user.

#### 4-1-1 Before Making Adjustments

##### 4-1-1 (a) ORIENTATION

When servicing, always face the monitor to the east.

##### 4-1-1 (b) MAGNETIC FIELDS

Whenever possible, use magnetic field isolation equipment such as a Helmholtz field to surround the monitor. If a Helmholtz field is not available, frequently degauss the unit under test.

**Caution:** Other electrical equipment may cause external magnetic fields which may interfere with monitor performance.

Use an external degaussing coil to limit magnetic build up on the monitor. If an external degaussing coil is not available, use the internal degaussing circuit. However, do not use the internal degaussing circuit more than once per 30 minutes.

##### 4-1-1 (c) WARM-UP TIME

The monitor must be on for 30 minutes before starting alignment. Warm-up time is especially critical in color temperature and white balance adjustments.

##### 4-1-1 (d) SIGNAL

Analog, 0.7 Vp-p positive at 75 ohm, internal termination

Sync: TTL level, negative/positive

##### 4-1-1 (e) SCANNING FREQUENCY

Horizontal: 30 kHz to 68 kHz (Automatic)

Vertical: 50 Hz to 160 Hz (Automatic)

Unless otherwise specified, adjust at the 1024 x 768 mode (68 kHz/85 Hz) signal.

Refer to Table 2-1 on page 2-3.

#### 4-1-2 Required Equipment

The following equipment may be necessary for adjustment procedures:

##### 4-1-2 (a) DISPLAY CONTROL ADJUSTMENT

1. Non-metallic (-) screwdriver:  
1.5, 2.5, 3 mm
2. Non-metallic (+) screwdriver:  
1.5, 2.5, 3 mm
3. Digital Multimeter (DMM), or  
Digital Voltmeter
4. Signal generator, or  
DM200 software
5. Software: Softjig or DM200
6. Interface Board Ver. 2.0 Code No.  
BH81-90001K
7. Parallel communications cable (25-pin to  
25-pin); Code No. BH81-90001H
8. Signal cable (15-pin to 15-pin cable with  
additional 3-pin connector); Code No.  
BH81-90001J
9. 5 V DC adapter, not supplied
10. Personal computer

**Note:** Softjig Ass'y (includes items 6, 7 and 9)  
Code No. BH81-90001L

##### 4-1-2 (b) COLOR ADJUSTMENTS

1. All equipment listed in 4-1-2 (a), above
2. Color analyzer, or any luminance  
measurement equipment

### 4-1-3 Connecting the SoftJig

Connect the monitor to the signal generator and/or PC as illustrated in Figures 4-1 and 4-2.

**Note:** The signal cable connector which includes the 3-wire cable must connect to the monitor. If you use Setup 2 (PC only, no signal generator) you can only make adjustments to the signal timing available on that computer system. To make corrections to all factory timings requires the use of an additional signal generator.

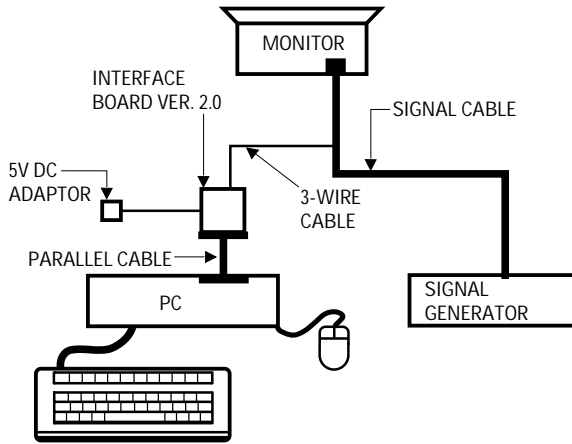

Figure 4-1. Setup 1, With Signal Generator

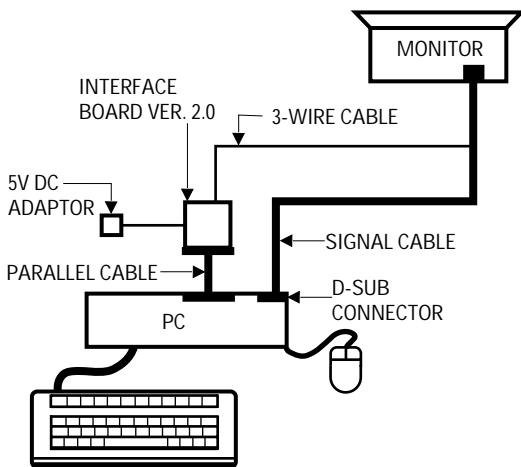

Figure 4-2. Setup 2, Without Signal Generator

## 4-2 Display Control Adjustments

### 4-2-1 HIGH VOLTAGE ADJUSTMENT

Signal: 1024 x 768 (68 kHz/85 Hz)  
 Display image: Full White Pattern  
 Contrast: Maximum  
 Brightness: Maximum  
 Limit: 26.0 kV ± 0.5 kV

Expert) TSB CDT = 26.5kV ± 0.2 kV

Measure the high voltage level at the anode cap. High voltage should be within the limit as above. If the high voltage needs adjustment use the following procedure.

PROCEDURE

1. Turn the power off and disconnect the AC line cord from the power source.
2. Turn the power on after connecting high voltage Probe.
3. Using the jig, adjust the high voltage to the specification.

\* High Voltage Adjustment PROCEDURE using Softjig

- ① Select matching model name in “Model” field.
- ② Select “@7: Zero Beam” in menu after selecting “Extra 1”
- ③ Adjust high voltage using control bar after selecting “HV MIN”
- ④ Turn the power off/on after adjustment finished.
- ⑤ Check the high voltage has been fixed with adjusted value after reselecting “@7: Zero Beam”.

### 4-2-2 SCREEN VOLTAGE CHECK

CONDITIONS

Signal: 1024 x 768 (68 kHz/85 Hz)  
 Display image: Full White Pattern  
 Contrast: Maximum  
 Brightness: Maximum  
 Limit: Refer to Table 4-1

No Adjustment.

Only check with below table.

Table 4-1

	CRT type	Screen Voltage
SDI	M41QAQ261X011	500V ± 10V
TSB	M41LH507XX443	630V ± 10V
PHS	M41EJB523X170	570V ± 10V

### 4-2-3 CENTER RASTER

Adjust SW401 so that the back raster comes to the center when you apply each basic mode.

### 4-2-4 Centering

Centering means to position the center point of the display in the middle of the display area. Horizontal size and position and vertical size and position control the centering of the display.

Adjust the horizontal size and vertical size to their optimal settings: 306 mm (H) x 230 mm.

Adjust the horizontal position and vertical position to ≤ 4.0 mm of the center point of the screen.

$$|A-B| \leq 4.0 \text{ mm} \qquad |C-D| \leq 4.0 \text{ mm}$$

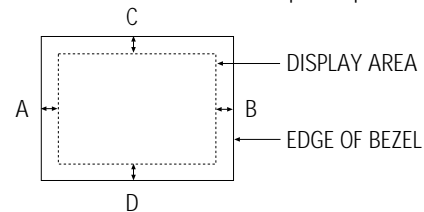

Figure 4-3. Centering

\* In Softjig window, “Geometry” has to be selected for GD adjustment.

#### 4-2-4 (a) HORIZONTAL SIZE ADJUSTMENT

CONDITIONS

Scanning frequency: 68 kHz/85 Hz  
 Display image: Crosshatch pattern  
 Brightness: Maximum  
 Contrast: Maximum

Use control bar after selecting “SIZE B+” in left menu to adjust the horizontal size of the display pattern to 306 mm with OSD “H-SIZE” fixed “39”. (Tolerance: ±3 mm.)

Specially run “All mode save” after horizontal size adjustment in order to save “SIZE B+” values of other modes automatically.

#### 4-2-4 (b) VERTICAL SIZE ADJUSTMENT

CONDITIONS

Scanning frequency: 68 kHz/85 Hz  
 Display image: Crosshatch pattern  
 Brightness: Maximum  
 Contrast: Maximum

Use control bar after selecting “V-SIZE” in left menu to adjust the vertical size of the display pattern to 234 mm. (Tolerance: ± 3 mm.)

## 4 Alignment and Adjustments

### 4-2-4 (c) HORIZONTAL POSITION ADJUSTMENT

#### CONDITIONS

Scanning frequency: 68 kHz/85 Hz  
 Display image: Crosshatch pattern

Use control bar after selecting “**H-POSITION**” in left menu to center the horizontal image on the raster.

### 4-2-4 (d) VERTICAL POSITION ADJUSTMENT

#### CONDITIONS

Scanning frequency: 68 kHz/85 Hz  
 Display image: Crosshatch pattern

Use control bar after selecting “**V-POSITION**” in left menu to center the vertical image on the raster.

### 4-2-5 Linearity

$$\text{Horizontal Linearity} = 2x \frac{X_{\text{max}} - X_{\text{min}}}{X_{\text{max}} + X_{\text{min}}} \times 100$$

$$\text{Vertical Linearity} = 2x \frac{Y_{\text{max}} - Y_{\text{min}}}{Y_{\text{max}} + Y_{\text{min}}} \times 100$$

Table 4-2

	Adjacent Linearity	Entire Linearity
Preset mode	≤ 4%	≤ 8%
Pre-load mode (48kHz-)	≤ 5%	≤ 10%
Pre-load mode (under 48kHz)	≤ 5%	≤ 14%

※ Preset Mode : 68KHz / 85Hz  
 Pre-load Mode : Refer to Timing Chart

### 4-2-5 (a) HORIZONTAL LINEARITY ADJUSTMENT

#### CONDITIONS

Scanning frequency: 68 kHz/85 Hz  
 Display image: Crosshatch pattern  
 Brightness: Maximum  
 Contrast: Maximum

To adjust the Horizontal Linearity, refer to Table 4-2 for the tolerance range.

Increase or decrease **H\_LIN** to optimize the image.

### 4-2-5 (b) VERTICAL LINEARITY ADJUSTMENT

#### CONDITIONS

Scanning frequency: 68 kHz/85 Hz  
 Display image: Crosshatch pattern  
 Brightness: Maximum  
 Contrast: Maximum

To adjust the Vertical Linearity, refer to Table 4-2 for the tolerance range.

Use control bar after selecting “**V-LINEARITY BAL**” in left menu to optimize the image.

### 4-2-6 Trapezoid Adjustment

#### CONDITIONS

Scanning frequency: 68 kHz/85 Hz  
 Display image: Crosshatch pattern  
 Brightness: Maximum  
 Contrast: Maximum

Use control bar after selecting “**TRAPEZOID**” in left menu to make the image area rectangular.

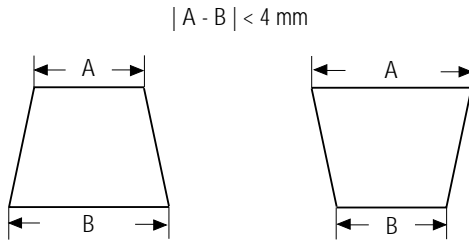

Figure 4-4. Trapezoid

### 4-2-7 Pinbalance Adjustment

#### CONDITIONS

Scanning frequency: 68 kHz/85 Hz  
 Display image: Crosshatch pattern  
 Brightness: Maximum  
 Contrast: Maximum

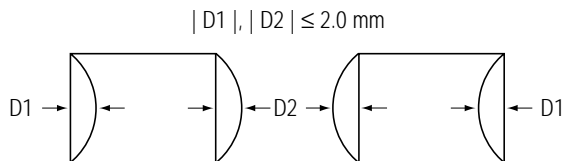

Figure 4-5. Pinbalance

Use control bar after selecting “**PINBALANCE**” in left menu to optimize the image.

### 4-2-8 Parallelogram Adjustment

#### CONDITIONS

Scanning Frequency: 68 kHz/85 Hz  
 Display image: Crosshatch pattern  
 Brightness: Maximum  
 Contrast: Maximum

Use control bar after selecting “**PARALLEL**” in left menu to make the image area rectangular.

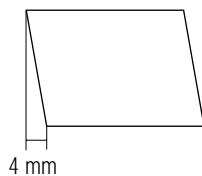

Figure 4-6. Parallelogram

### 4-2-9 Side Pincushion Adjustment

#### CONDITIONS

Scanning frequency: 68 kHz/85 Hz  
 Display image: Crosshatch pattern

Use control bar after selecting “**PINCUSHION**” in left menu to straighten the sides of the image area.

$$|C1|, |C2| \leq 2.0 \text{ mm}, |D1|, |D2| \leq 2.0 \text{ mm}.$$

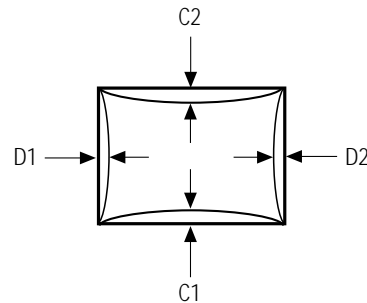

Figure 4-7. Pincushion

### 4-2-10 Tilt Adjustment

#### CONDITIONS

Scanning Frequency: 68 kHz/85 Hz  
 Display image: Crosshatch pattern  
 Brightness: Maximum  
 Contrast: Maximum

Use control bar after selecting “**ROTATION**” in left menu to correct the tilt of the display.

### 4-2-11 Degauss

No adjustments are available for the degaussing circuit. The degaussing circuit can effectively function only once per 30 minutes.

### 4-2-12 To Delete the User Mode Data

To delete the adjustment data from the user modes, click “@4: **USER DELETE**” in right ment.

### 4-2-13 Save the Data

To save the adjustment data for a mode, press “@3: **ALL MODE SAVE**” in right ment.

## 4-3 Color Adjustments

CAUTION: Check below condition before color adjustment  
Video signal : Analog 0.7 Vp-p (at 75  $\Omega$ )  
Sync : TTL level (H, V separate signal)

\* Select "Color" in Softjig menu for color adjustment.

### 4-3-1 Color Coordinates (Temperature)

Color temperature is a measurement of the radiant energy transmitted by a color. For computer monitors, the color temperature refers to the radiant energy transmitted by white. Color coordinates are the X and Y coordinates on the chromaticity diagram of wavelengths for the visible spectrum.

#### CONDITIONS

Measurement instrument: Color analyzer  
Scanning frequency: 68 kHz/85 Hz  
Display image: White flat field at center of display area  
Luminance: Maximum

#### PROCEDURE

Use the directions in sections 4-3-2 through 4-3-3 to adjust the color coordinates for:

9300K to  $x = 0.283 \pm 0.02$ ,  $y = 0.298 \pm 0.02$   
6500K to  $x = 0.313 \pm 0.02$ ,  $y = 0.329 \pm 0.02$

### 4-3-2 Color Adjustments for 9300K

#### 4-3-2 (a) BACK RASTER COLOR ADJUSTMENT

#### CONDITIONS

Scanning frequency: 68 kHz/85 Hz  
Display image: Back raster pattern  
Brightness: Maximum  
Contrast: Maximum

1. Select "@1: CHANNEL 1" in right menu to control the color for 9300K.
2. Adjust the luminance of the back raster to between 0.5 to 0.7 ft-L using control bar after selecting "GREEN CUTOFF" in the menu.
3. Use control bar after selecting "BLUE CUTOFF" in left menu to set the "y" coordinate to  $0.298 \pm 0.015$
4. Use control bar after selecting "RED CUTOFF" in left menu to  $0.283 \pm 0.015$

\* If color values would not be matched desirable values, repeat sequence 3 and 4 after readjusting "GREEN CUTOFF" control a little different.

#### 4-3-2 (b) R.G.B - GAIN ADJUSTMENT

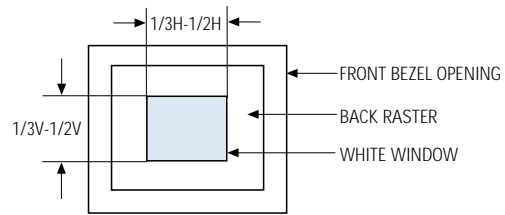

Figure 4-8. White Box Pattern

#### CONDITIONS

Scanning frequency: 68 kHz/85 Hz  
Display image: Green box pattern  
Brightness: Cut-off  
Contrast: Maximum

1. Click on the << or >> box next to R,G,B \_GAIN to adjust the brightness of the Green Gain to  $36 \pm 1$  ft-L.

#### 4-3-2 (c) WHITE BALANCE ADJUSTMENT

#### CONDITIONS

Scanning frequency: 68 kHz/85 Hz  
Display image: Full white pattern  
Brightness: Cut-off  
Contrast: Maximum

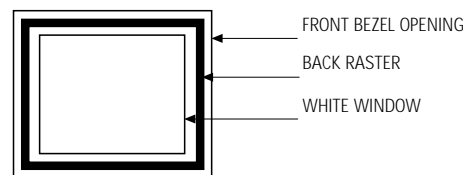

Figure 4-9. Full White Pattern

1. Click on the << or >> boxes next to R\_GAIN and B\_GAIN to make the video white. (For 9300K color adjustment:  $x = 0.283 \pm 0.02$ ,  $y = 0.298 \pm 0.02$ .)  
**Note:** Do not touch the G\_GAIN controls.
2. Check the ABL. If it is not within the specifications ( $30 \pm 1$  ft-L), use the ABL controls to adjust it.
3. Select COLOR FACTORY SAVE to save the data.

#### 4-3-2 (d) WHITE BALANCE ADJUSTMENT VERIFICATION

#### CONDITIONS

Scanning frequency: 68 kHz/85 Hz



Display image:	Back raster pattern Full White Pattern
X-Y Coordinates:	$x = 0.283 \pm 0.02$ , $y = 0.298 \pm 0.02$
ABL Luminance	Refer to 4-3-2(c)
Brightness:	Maximum
Contrast:	5 ft-L, 24 ft-L

1. Check whether the color coordinates of the back raster satisfy the above spec.  
If they do not, return to 4-3-2 (a) and readjust all settings.
2. Display a full white pattern.
3. Select "Geometry" in softjig menu.
4. Select "@7: 5-ft " in right menu.
5. Check whether the white coordinates of the video meet the above coordinates spec.
6. Select "@8: 24-ft " in right menu.
7. Check whether the white coordinates of the video satisfies the above spec.  
If they do not, return to 4-3-2 (a) and readjust all settings.

Select "Color" and click "@2: CHANNEL 2" for color adjustment for 6500K  
Repeat the sequence of 9300K adjustment.  
The luminance values the same as 9300K, but the color coordinated of back raster and white box are :  $x = 0.313 \pm 0.015$   $y = 0.329 \pm 0.015$

### 4-3-3 Luminance Uniformity Check

Luminance is considered uniform only if the ratio of lowest to highest brightness areas on the screen is not less than 7.5:10.

#### CONDITIONS

Scanning frequency:	68 kHz/85 Hz (1024 x 768)
Display image:	White flat field
Brightness:	Cut off point at 24 ft-L
Contrast:	Maximum

#### PROCEDURE

Measure luminance at nine points on the display screen (see figure below).

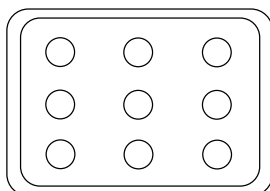

Figure 4-10. Luminance Uniformity Check Locations

### 4-3-4 Focus Adjustment

#### CONDITIONS

Scanning frequency:	68 kHz/85 Hz (1024 x 768)
Display image:	"H" character pattern
Brightness:	Cut off point
Contrast:	Maximum

#### PROCEDURE

1. Adjust the Focus VR on the FBT to display the sharpest image possible.
2. Use Locktite to seal the Focus VR in position.

### 4-3-5 Color Purity Adjustment

Color purity is the absence of undesired color. Conspicuous mislanding (unexpected color in a uniform field) within the display area shall not be visible at a distance of 50 cm from the CRT surface.

#### CONDITIONS

Orientation:	Monitor facing east
Scanning frequency:	68 kHz/85 Hz)
Display image:	White flat field
Luminance:	Cut off point at the center of the display area

**Note:** Color purity adjustments should only be attempted by qualified personnel.

#### PROCEDURE

**For trained and experienced service technicians only.**

Use the following procedure to correct minor color purity problems:

1. Make sure the display is not affected by external magnetic fields.
2. Make sure the spacing between the PCM assembly and the CRT stem is  $29 \text{ mm} \pm 1 \text{ mm}$ .
3. Display a green pattern over the entire display area.
4. Adjust the purity magnet rings on the PCM assembly to display a pure green pattern.  
(Optimum setting:  $x = 0.295 \pm 0.015$ ,  $y = 0.594 \pm 0.015$ )

Table 4-4. Color Purity Tolerances

Red:	$x = 0.640 \pm 0.015$	$y = 0.323 \pm 0.015$
Green:	$x = 0.295 \pm 0.015$	$y = 0.594 \pm 0.015$
Blue:	$x = 0.142 \pm 0.015$	$y = 0.066 \pm 0.015$

(For 9300K color adjustment:  $x = 0.283 \pm 0.02$ ,  $y = 0.298 \pm 0.02$ )

5. When you have the PCMs properly adjusted, carefully glue them together to prevent their movement during shipping.

## Memo

# 5 Troubleshooting

## 5-1 Parts Level Troubleshooting

**Notes:** Check the following circuits.

- No raster appears: Power circuit, Horizontal output circuit.
- High voltage develops but no raster appears: Video output circuits.
- High voltage does not develop: Horizontal output circuits.

### 5-1-1 No Power Supply

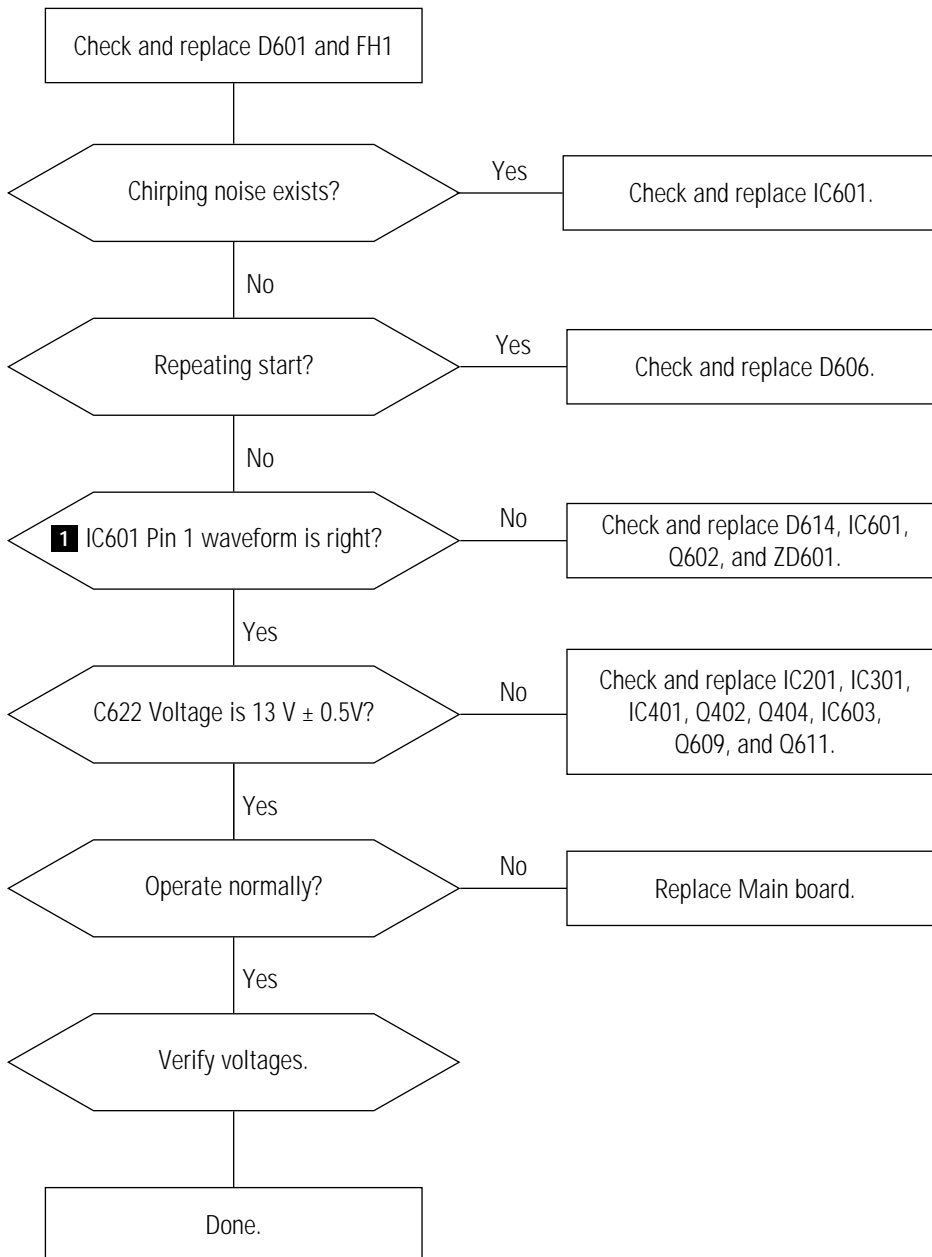

### WAVEFORMS

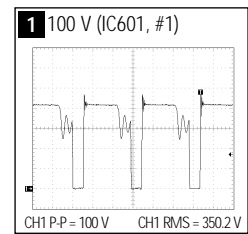

### 5-1-2 DPMS Failure

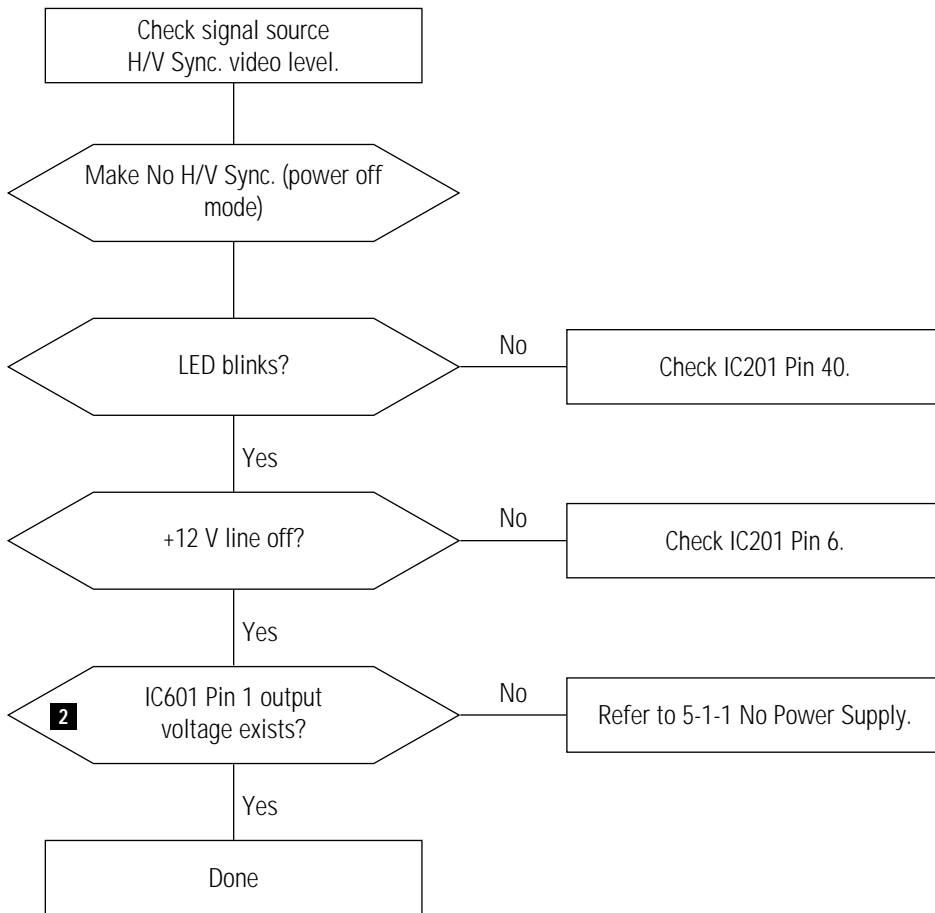

### WAVEFORMS

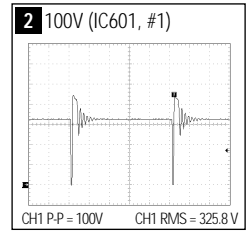

### 5-1-3 H\_Deflection Failure

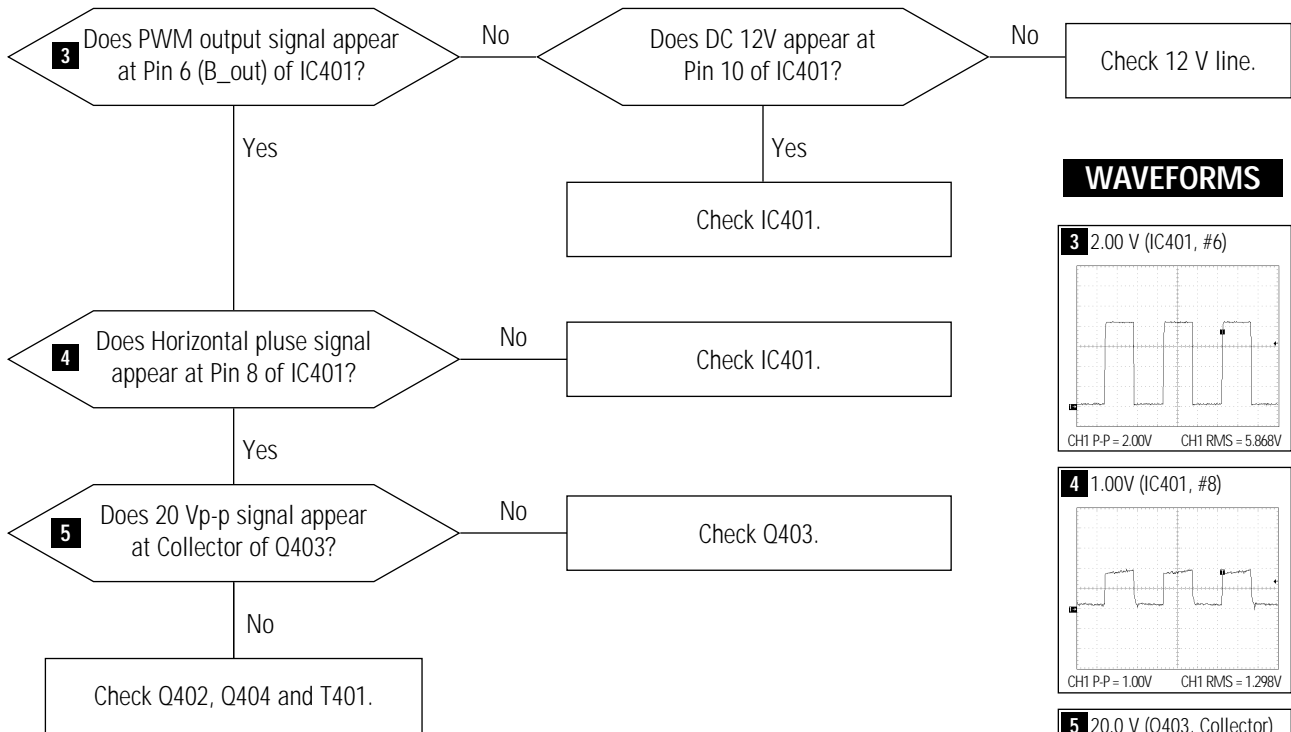

#### WAVEFORMS

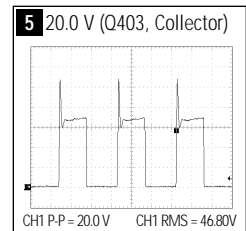
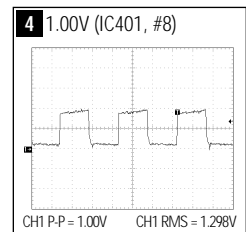
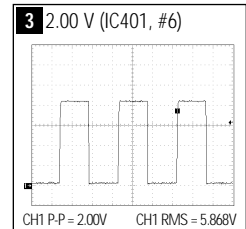

### 7-1-4 S Correction Failure

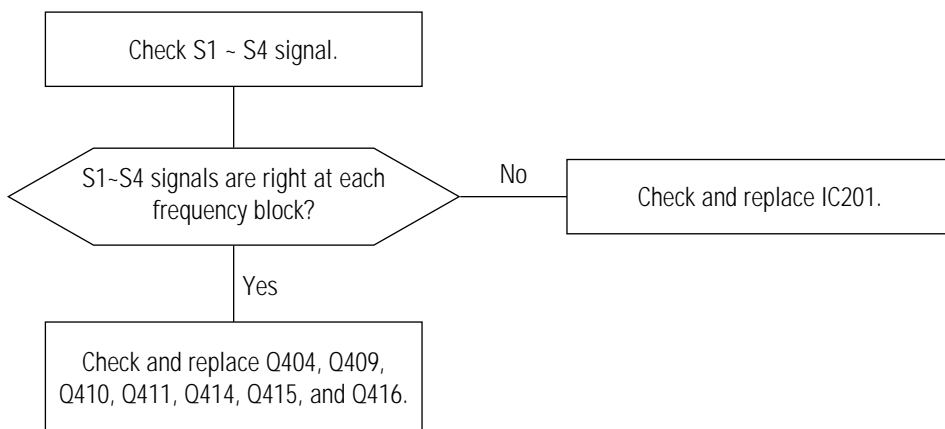

### 5-1-5 H\_Lin. Failure

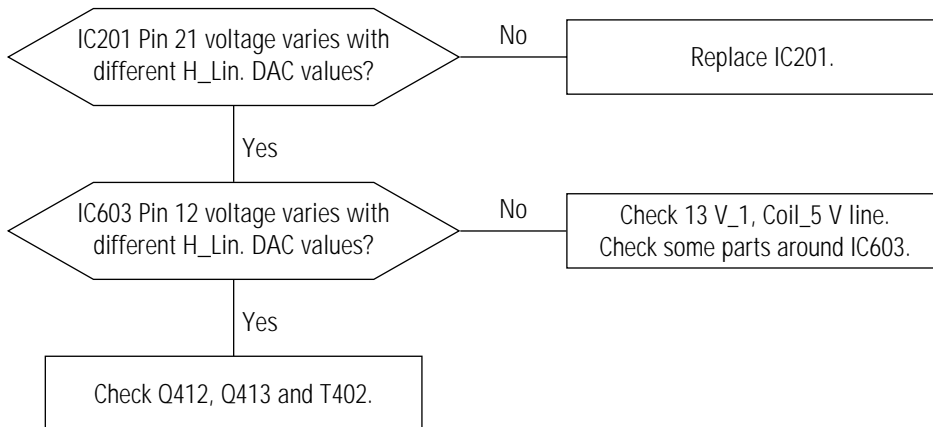

### 5-1-6 Invariable H\_Size

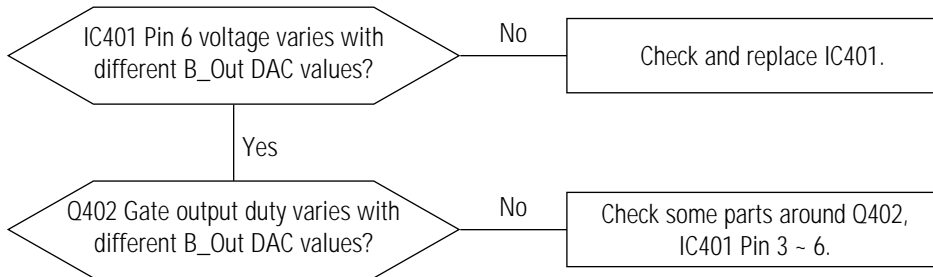

### 5-1-7 Abnormal H\_Size

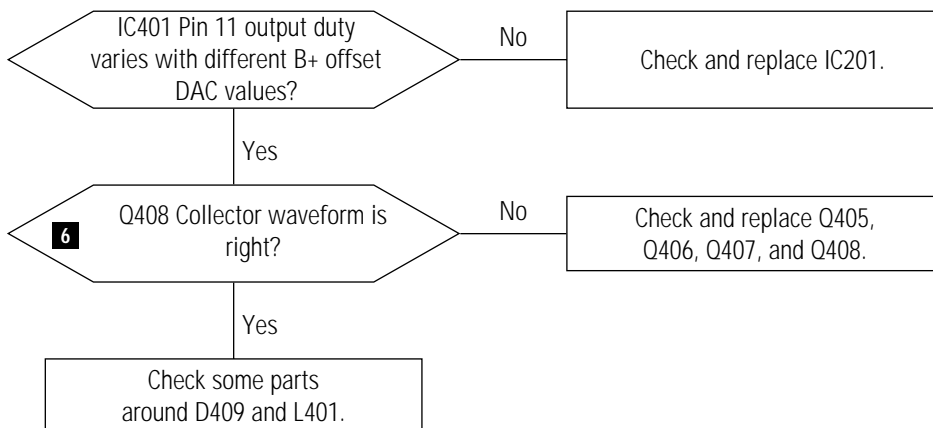

#### WAVEFORMS

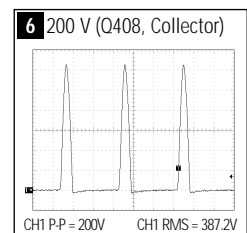

### 5-1-8 Side Pin or Trap Failure

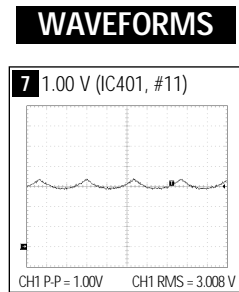
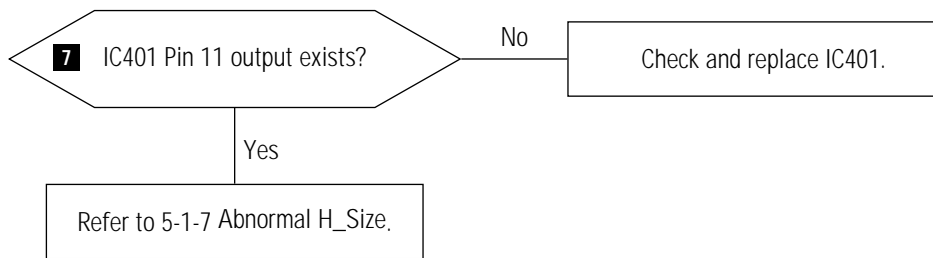

### 5-1-9 Para. or Pin Balance Failure

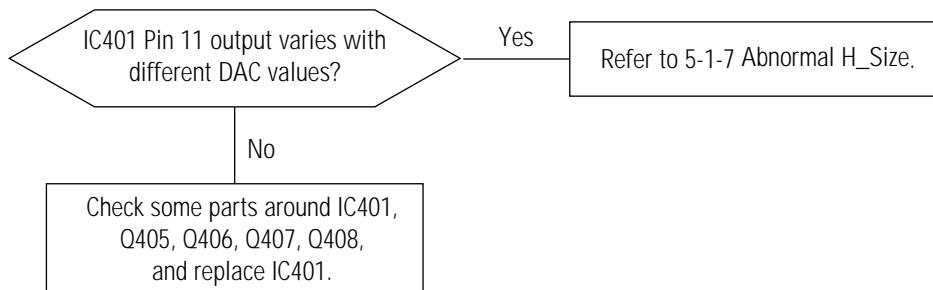

### 5-1-10 Tilt Failure

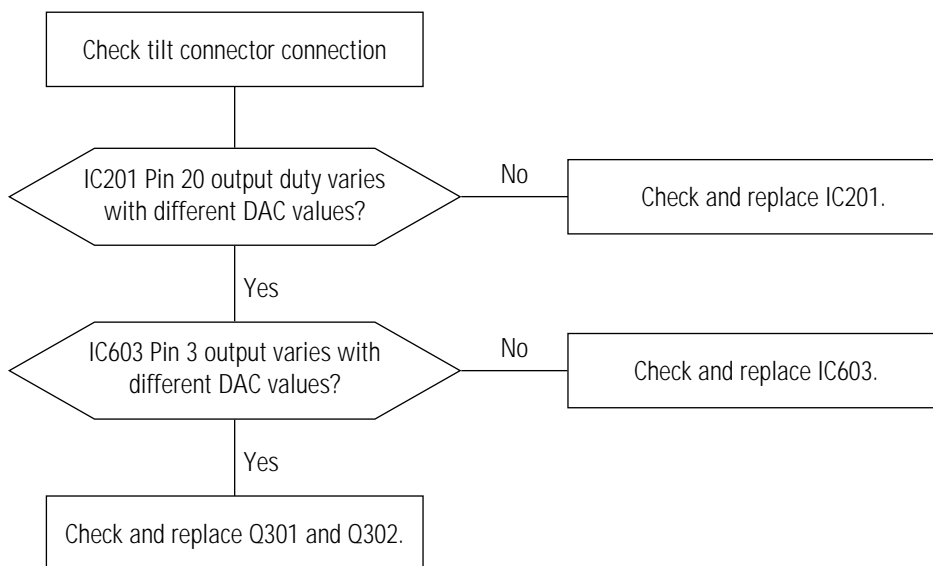

### 5-1-11 V Deflection Failure

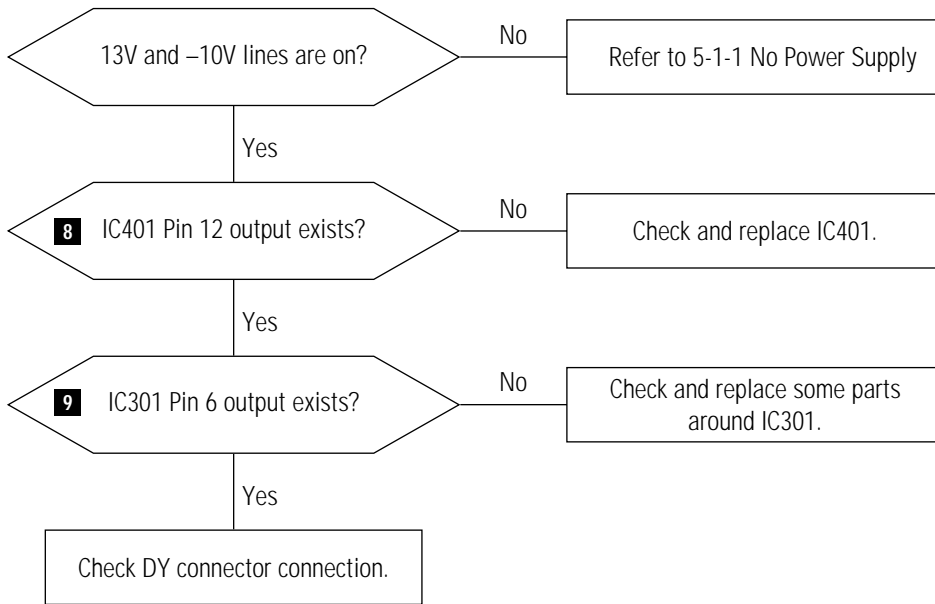

### WAVEFORMS

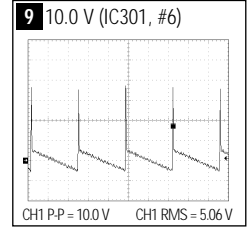
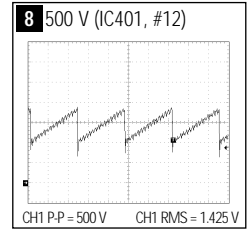

### 5-1-12 V Size or Position Variation Failure

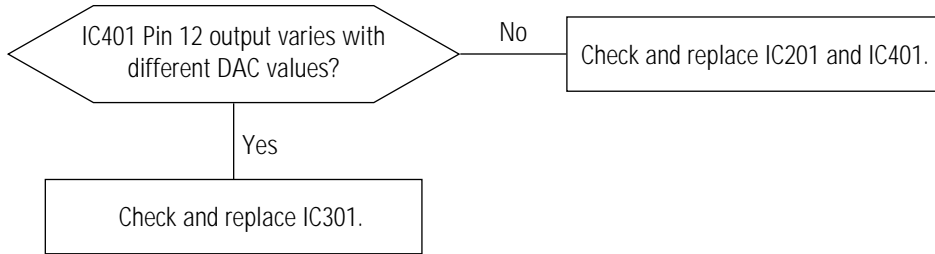



### 5-1-13 High Voltage Failure

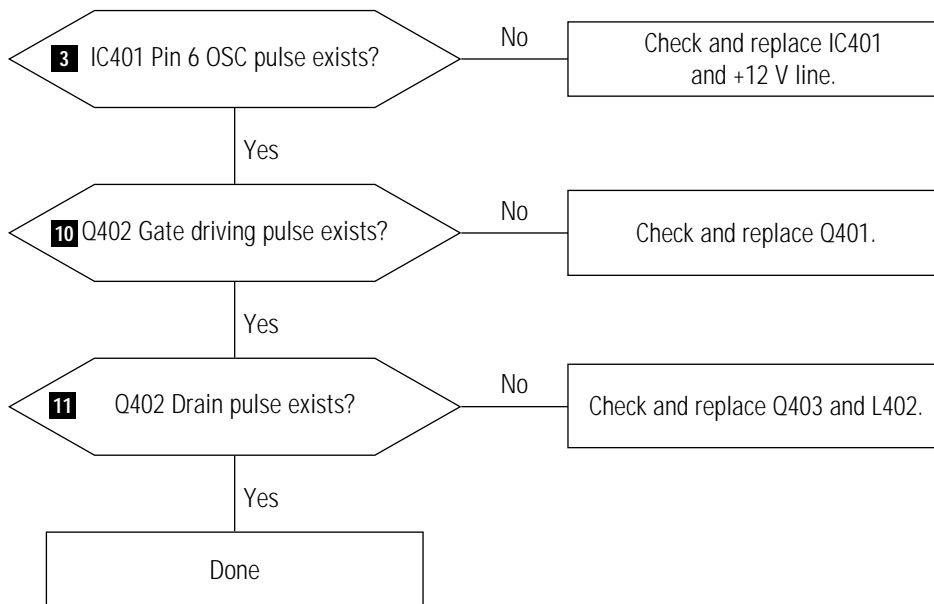

### WAVEFORMS

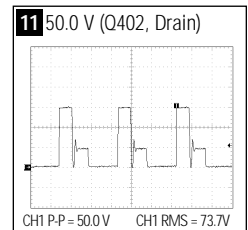
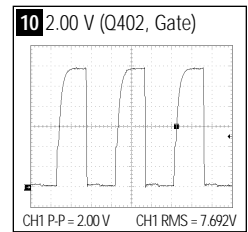
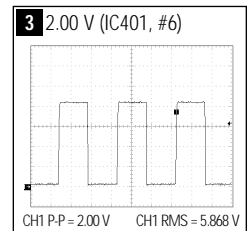

### 5-1-14 ABL Failure

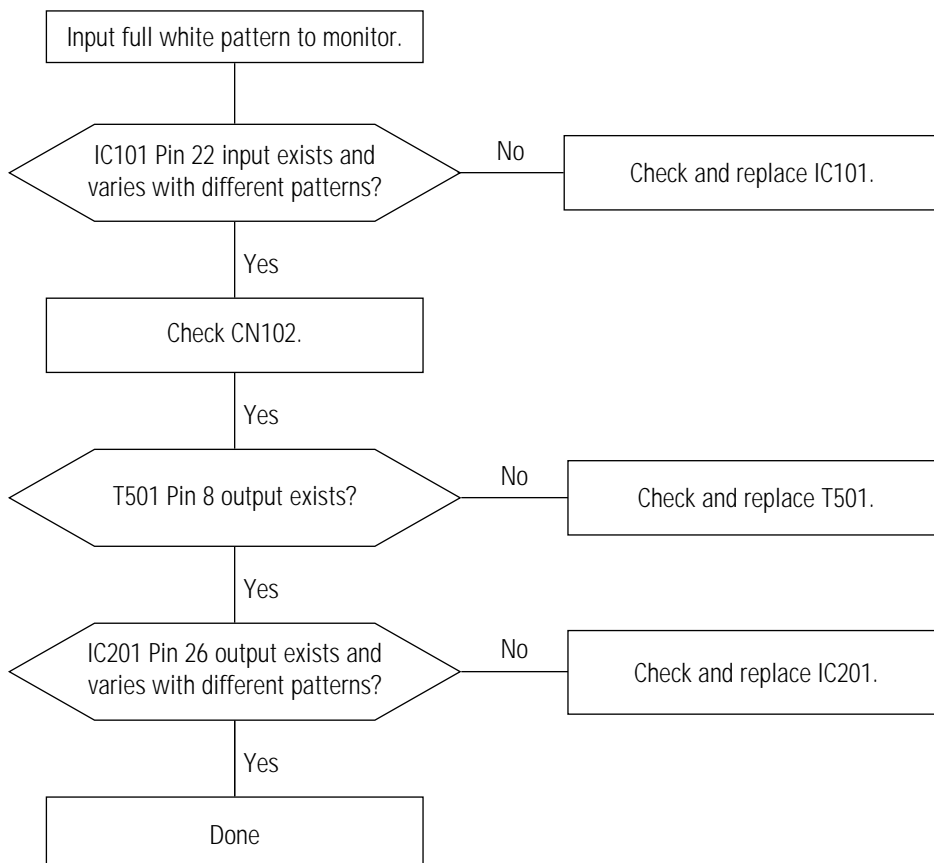

### 5-1-15 Dynamic Focus Failure

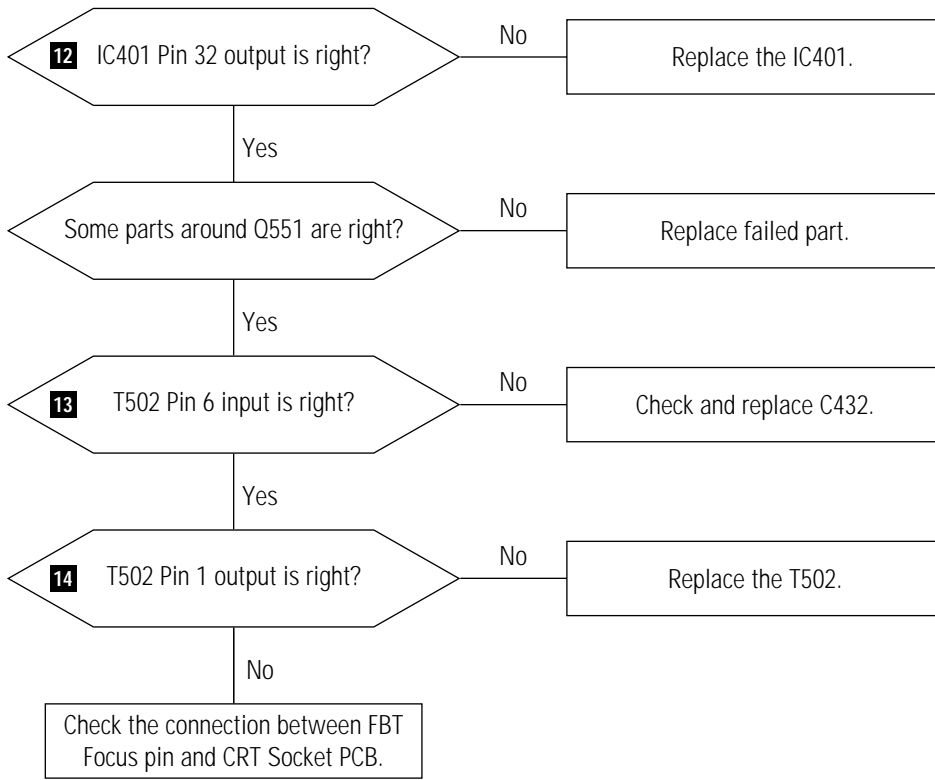

### WAVEFORMS

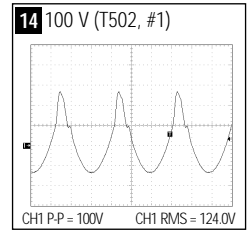
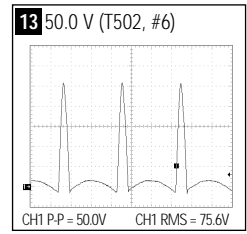
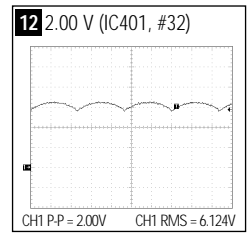

5-1-16 No Video

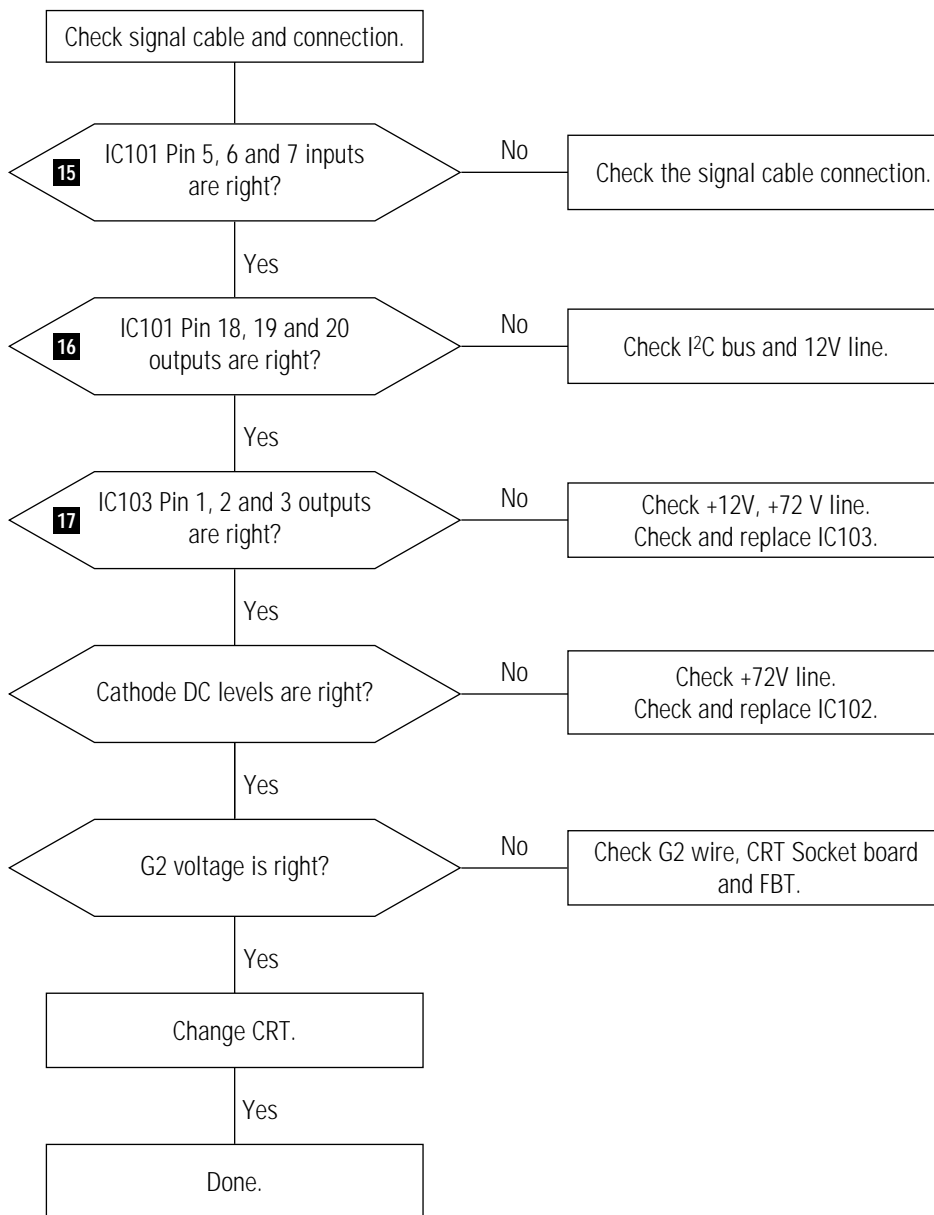

**WAVEFORMS**

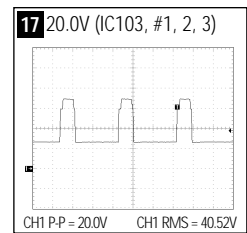
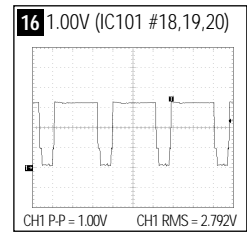
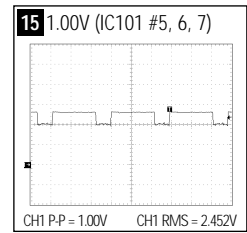

### 5-1-17 Micom Failure

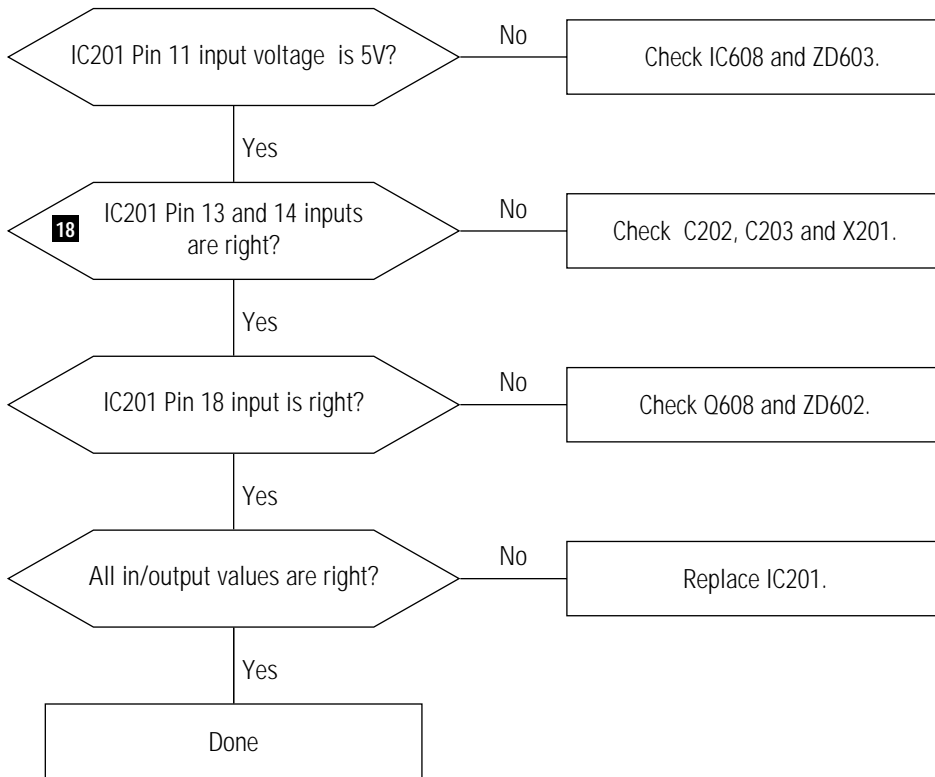

#### WAVEFORMS

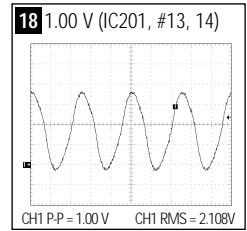

### 5-1-18 OSD Failure

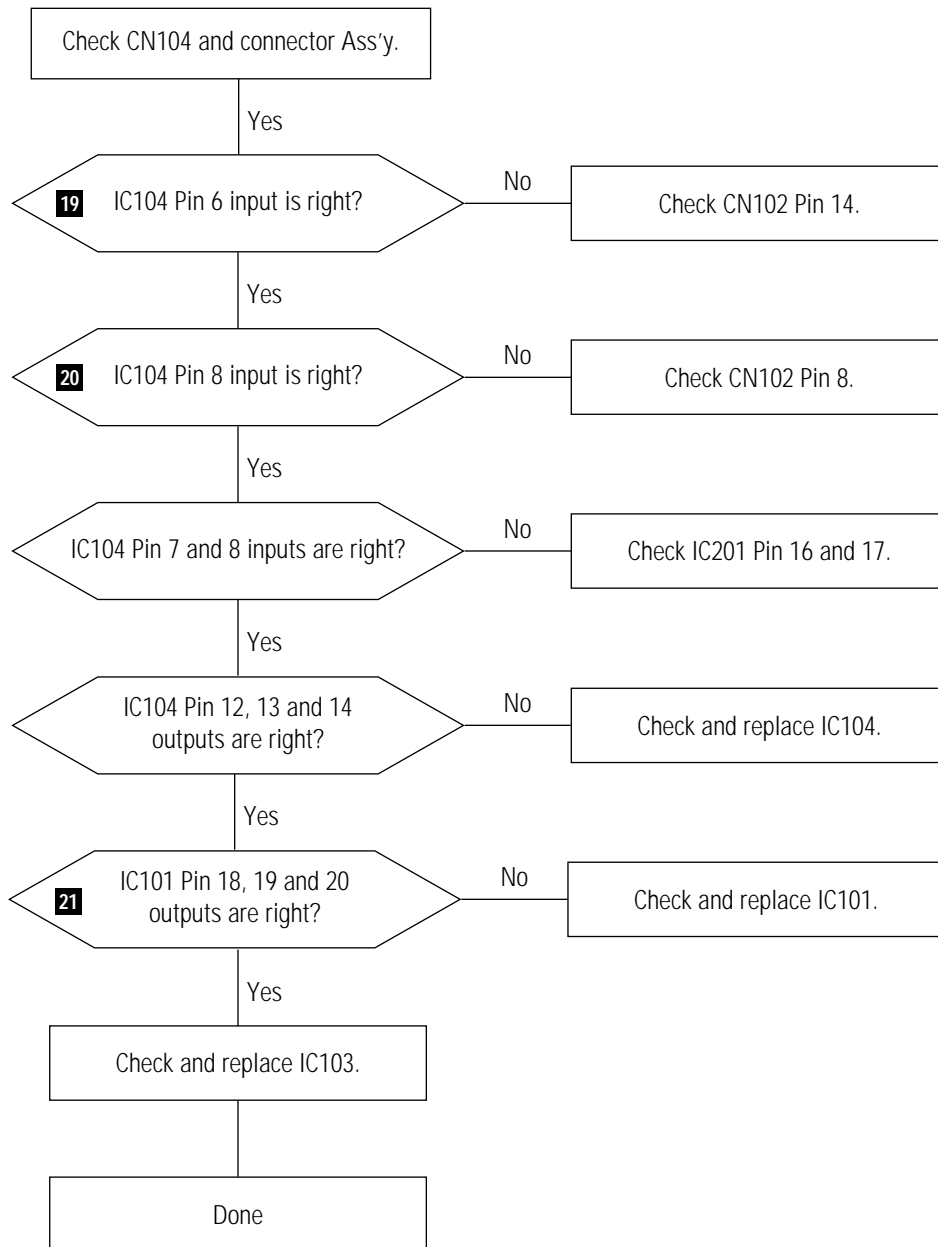

#### WAVEFORMS

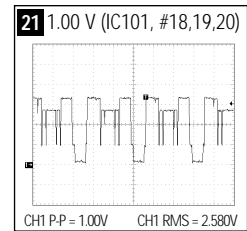
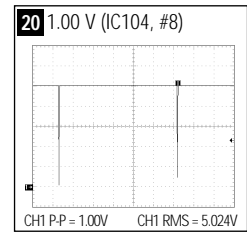
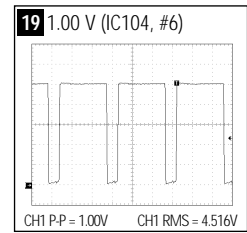

### 5-1-19 User Control Failure

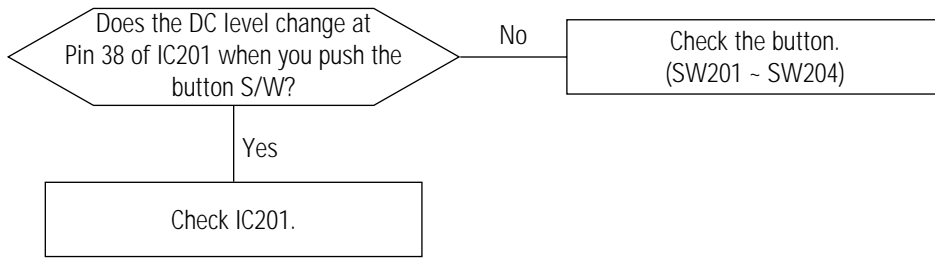

### 5-1-20 Degaussing Failure

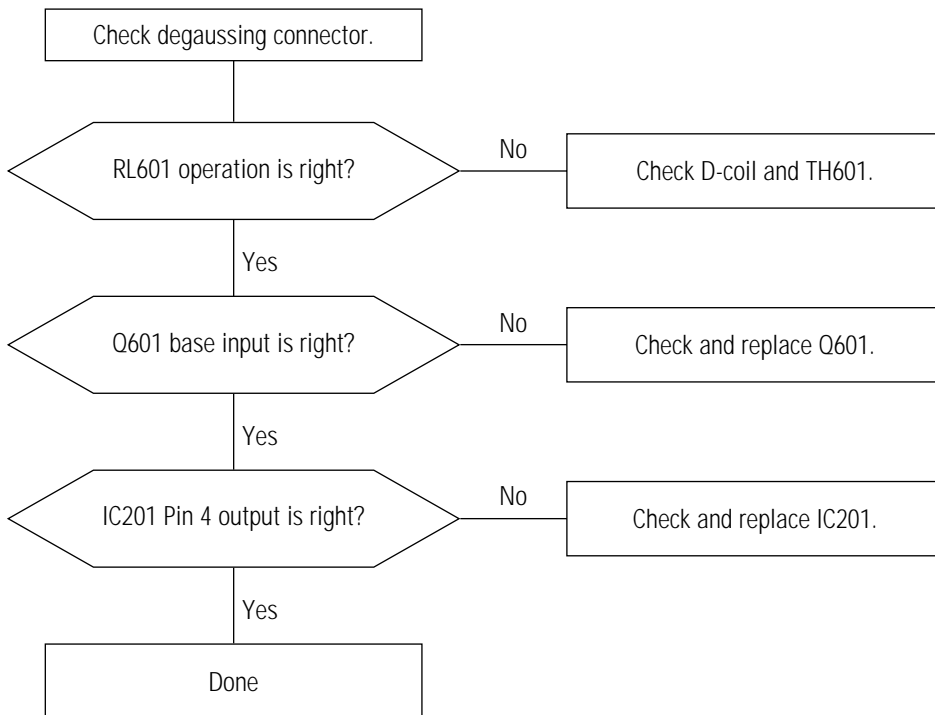

## 5-2 General Troubleshooting

### 5-2-1 No Picture

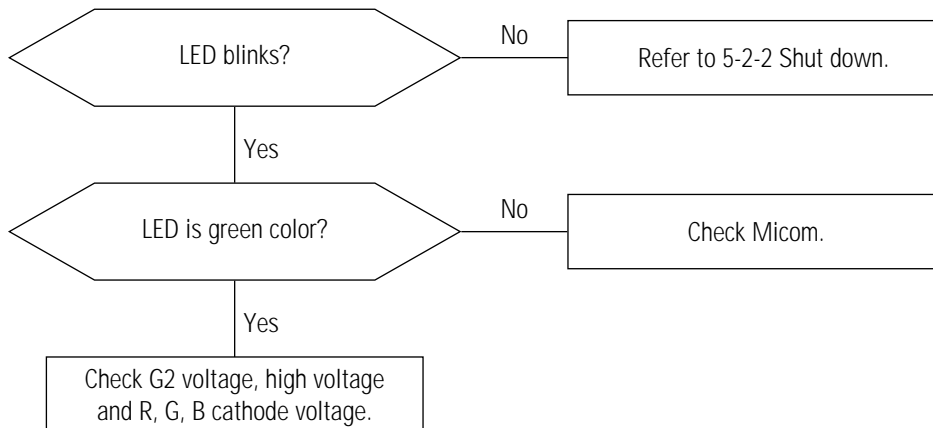

### 5-2-2 Shut Down

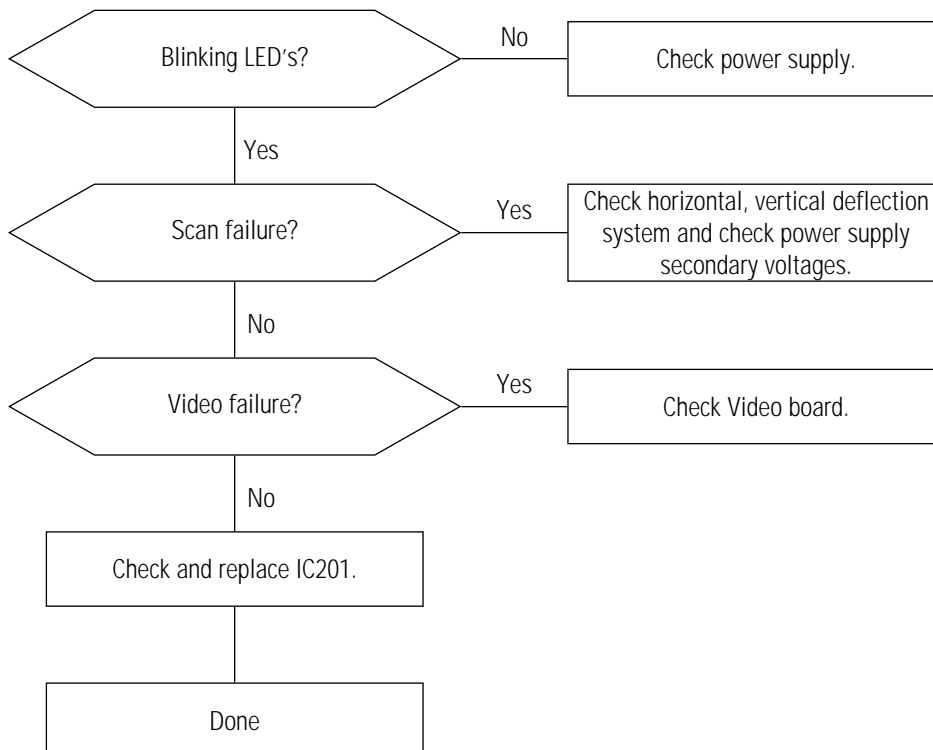

### 5-2-3 Missing Color

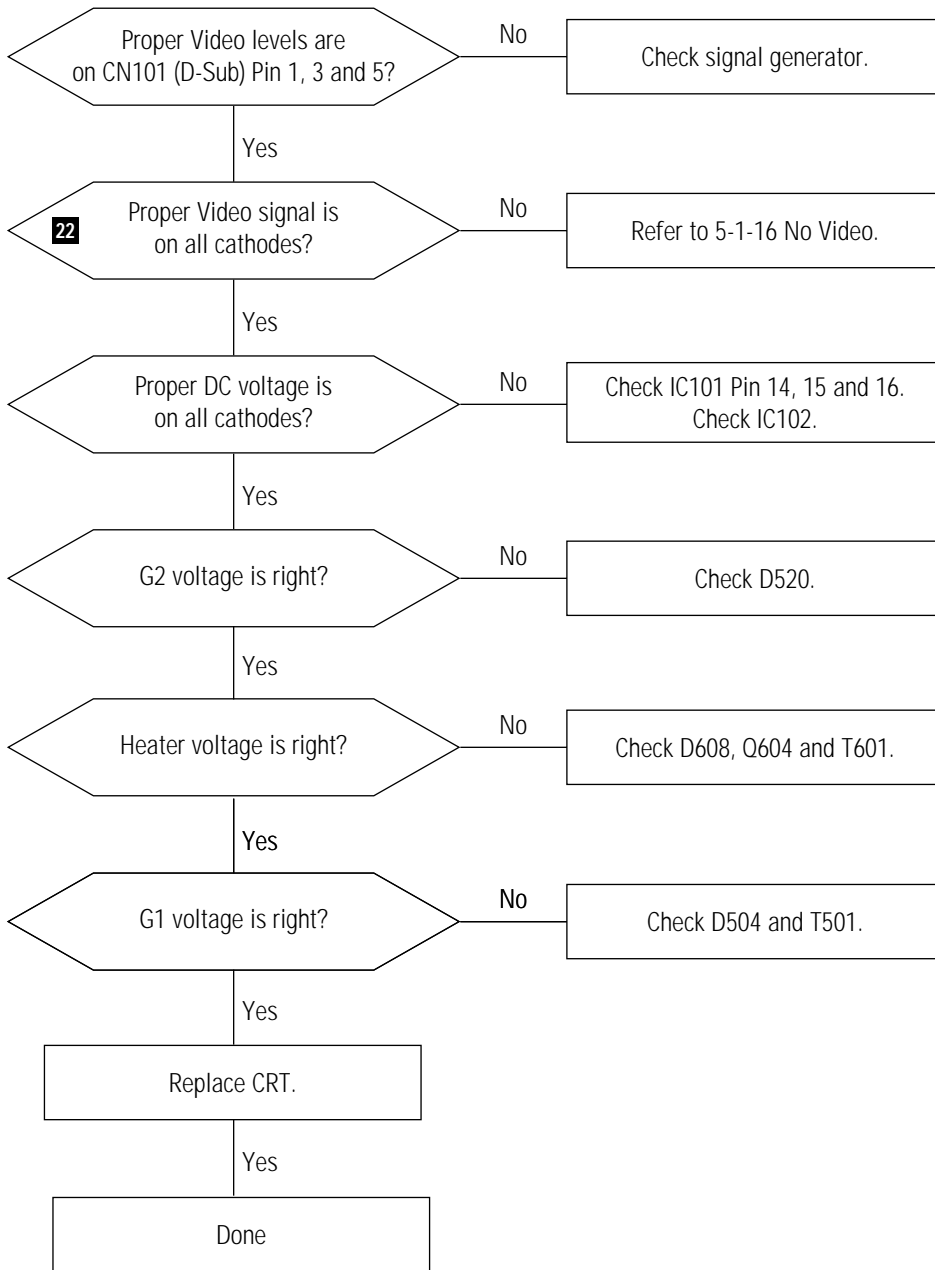

### WAVEFORMS

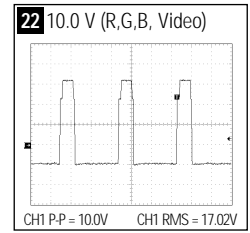



### 5-2-4 Visible Retrace

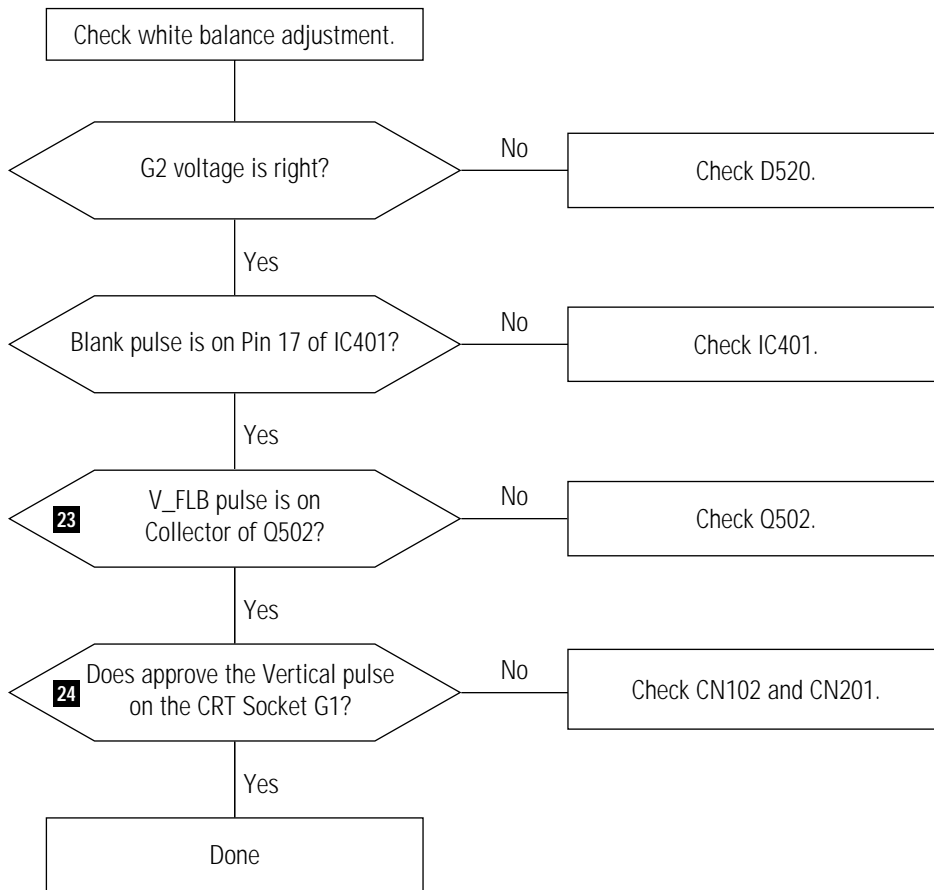

#### WAVEFORMS

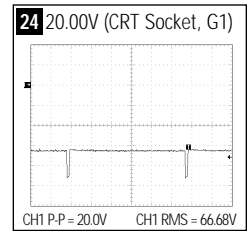
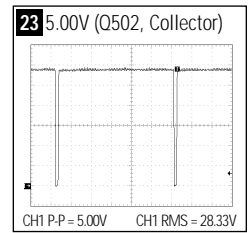

### 5-2-5 Unsynchronized Image

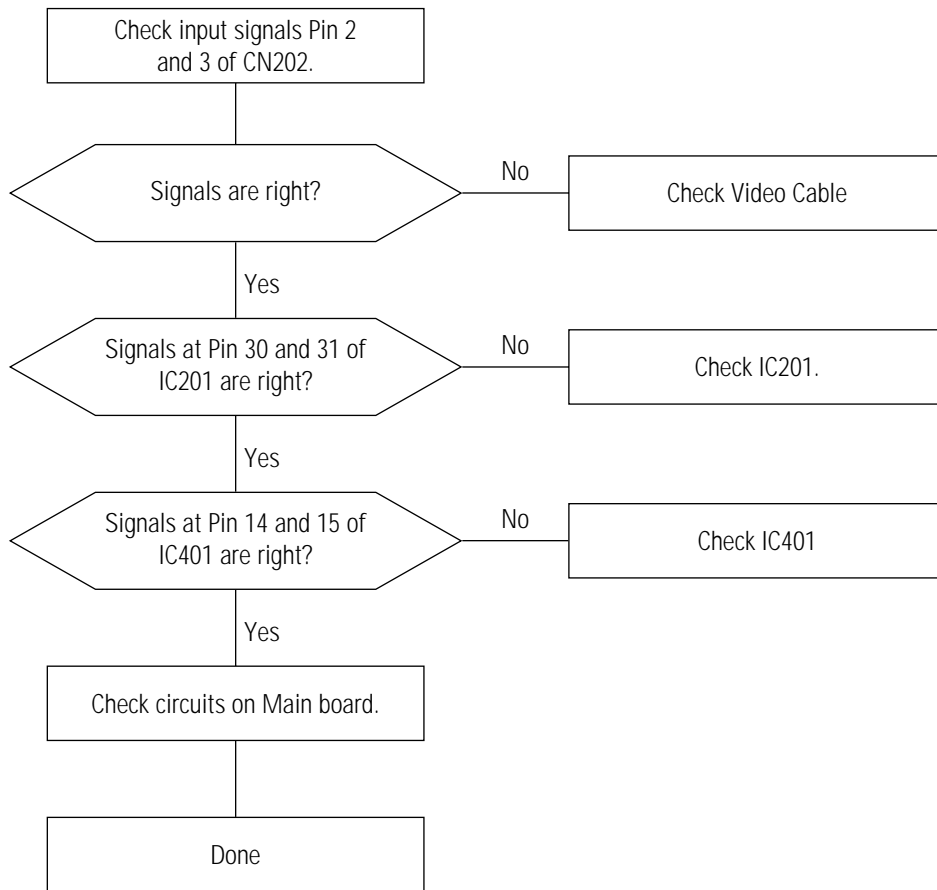

### 5-2-6 Misconvergence

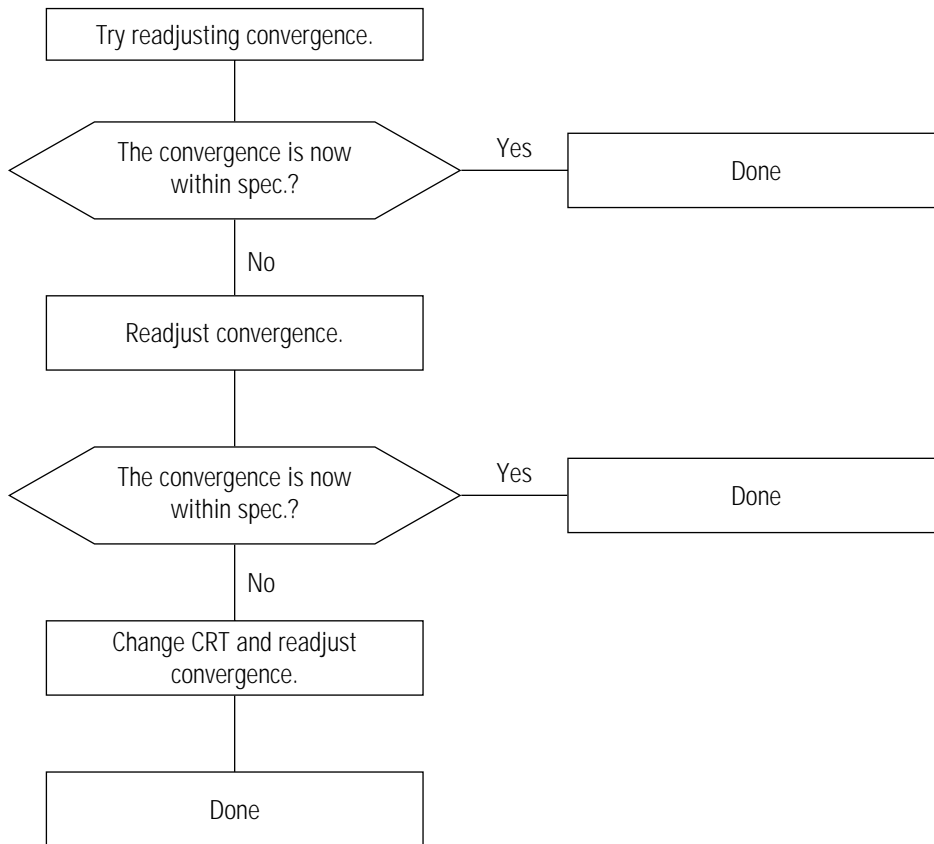

### 5-2-7 Poor Focus

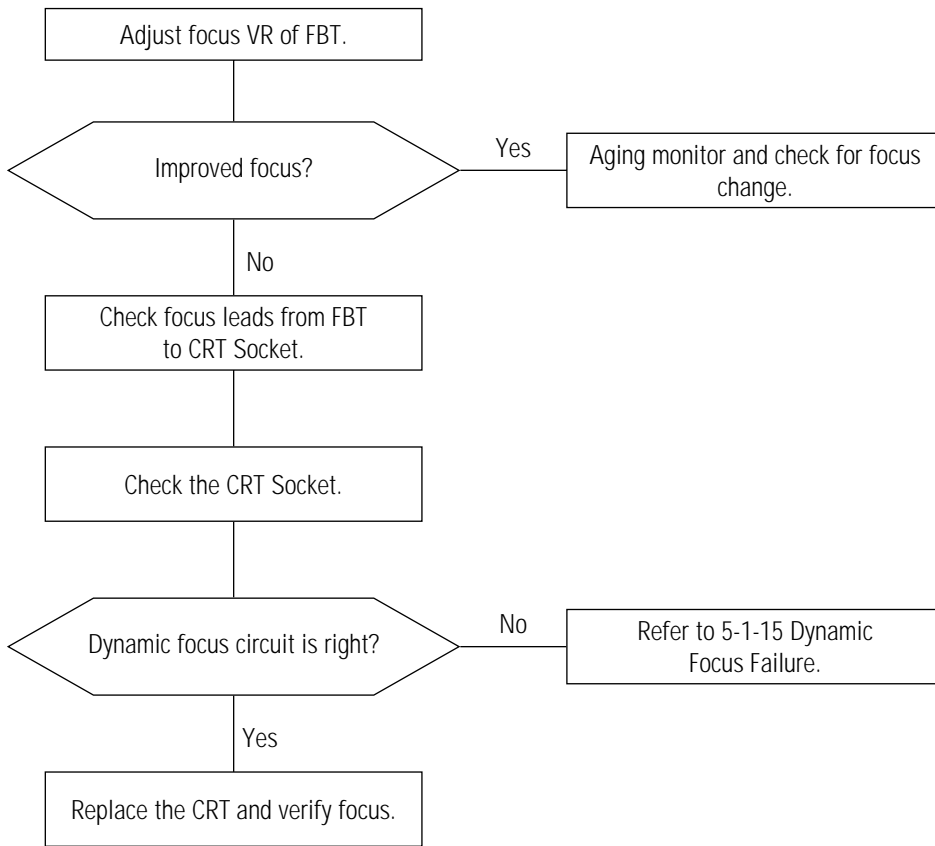

### 5-2-8 Purity Failure

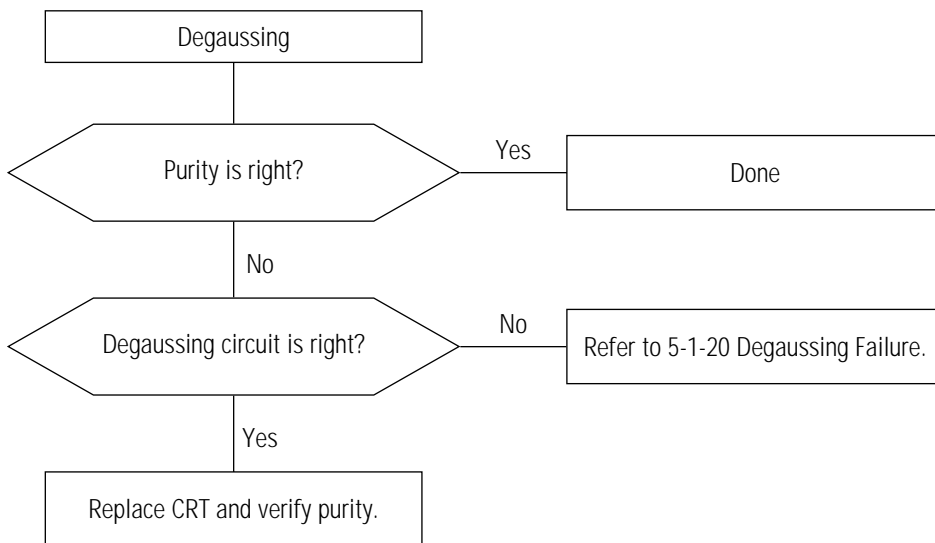

# 7 Electrical Parts List

## 7-1 Main PCB Parts

Loc. No.	Code No.	Description	Specification	Remarks
C409	2306-000248	"C-FILM,MPPF"	680nF,5%,250V,BK,26.5x16.5mm,2	
C430	2301-001125	C-FILM,MPPF	600nF,5%,250V,TP,26x20x11.5,20	
C432	2305-000310	C-FILM,MPEF	22nF,5%,250V,TP,14.5x8.8mm,7.5	
C512	2201-000020	C-CERAMIC,DISC	10nF,10%,1kV,Y5P,BK,18x5,10	
C601	2301-001195	C-FILM,MPPF	150nF,10%,275VAC,BK,26x16.5x7,	
C602	2301-001195	C-FILM,MPPF	150nF,10%,275VAC,BK,26x16.5x7,	
C608	2401-000863	C-AL	220uF,20%,400V,WT,BK,30x35,10	
CIS	3301-000233	CORE-FERRITE	ZZ,18x9.5x28mm,-,-	SNA
CIS	BH68-00001A	LABEL/MARK-CDT	ART-PAPER 100G,-,WHT,BLK,-,ALL,CDT	SNA
CIS	BH71-00108A	SHIELD-VIDEO/CAP	PN15VT,SPT,TO.2,-,-,-	SNA
CIS	BH72-00025A	GUIDE-POWER	CDA4507,ABS+PC,5V,IV16,-,-	SNA
CIS	BH72-00026A	SHAFT-POWER	CDA4507,ABS+PC,5V,IV16,-,-	SNA
CIS	BH72-00299A	SHEET-LMF(LOW)	PN17LT,AL+PC TO.35,-,-,-,-,-	SNA
CIS	BH73-60304C	RUBBER-SUPPORT	DP15LT,CR V0,GRAY,-,14*7*10,-,-	SNA
CIS	BH75-00275A	UNIT-SHIELD/BOTTOM	PN17LT,-,SECC,-,-,-,T1.0	SNA
CIS	6003-000103	SCREW-TAPTITE	BH,+B,M2.6,L10,ZPC(YEL),SWRCH	SNA
CIS	BH71-00110A	SHIELD-BOTTOM	PN15VT,SECC,T1.0,-,-,-	SNA
CIS	BH72-00297A	SUPPORT-PCB	PN15VT,ABS VO,IV16,-,-,-,-,-	SNA
CIS	BH75-00277A	UNIT-SHIELD/VIDEO	PN17LT,-,SPT,-,-,-,TO.2	SNA
CIS	BH61-00002A	SPRING-VIDEO	CDB7907,STS H14,T1.0,-,-,-,NORMAL CDT	SNA
CIS	BH71-00107A	SHIELD-VIDEO	PN15VT,SPT,TO.2,-,-,-	SNA
CIS	BH72-00024A	HOLDER-VIDEO	CDA4507,ABS+PC,5V,IV16,-,NORMAL CRT	SNA
CIS	BH73-00014A	HOLDER-RUBBER(NORMAL)	DEL,SILICON V2,GRAY,-,-,-,NORMAL	SNA
CIS	BH46-00002N	MICOM-S/W,PN19LT	PN19LT(PHOEINX),-,-,-,-,-	SNA
CN_DY	3711-003989	CONNECTOR-HEADER	NOWALL,4P,1R,8mm,STRAIGHT,SN	SNA
CN101	3711-004228	CONNECTOR-HEADER	BOX,6P,1R,2MM,ANGLE,SN	SNA
CN102	BH39-00280A	CBF HARNESS	PN17L,UL1007,UL/CSA,13P/14P,350MM,BLU/WHT/RED,AWG26,SMH200-13,YBNH200-14,-,-,-,-	
CN201	3711-003895	CONNECTOR-HEADER	BOX,13P,1R,2mm,STRAIGHT,SN	SNA
CN202	3711-003873	CONNECTOR-HEADER	BOX,7P,1R,2mm,STRAIGHT,SN	SNA
CN203	BH39-00288A	CBF HARNESS	PN17L,UL1007,UL/CSA,2P/2P,130MM,BLU/WHT,AWG26,YBNH200,SMP250,-,-,-,-,-,CBF-CO	SNA
CN501_G2	BH39-00232A	CBF-HARNESS	DP17MO,UL1032,UL/CSA,1P,290MM,RED,AWG22,YHF800-1,-,-,-,-,-,CBF-CONN ASSY	SNA
CN502	3711-000024	CONNECTOR-HEADER	BOX,3P,1R,2.5mm,STRAIGHT,SN	SNA
CN502_W	BH39-00149A	CBF-HARNESS	3P,150MM,BLK,UL1007,AWG22,SMH250-03	
CN601	BH39-00326A	W/HARNESS SOCKET-AC INLET	PN15H,UL1015,UL/CSA,5P,115mm,GREN/YELLOW,AWG18,ST780400-3,-,BK,AC250V/10A,35*14,	
D406	0402-001025	DIODE-RECTIFIER	ERD07-15,1.5KV,1.5A,-,TP	△
D409	0402-001295	DIODE-RECTIFIER	GUR460L-5700,600V,4A,DO-201AD,BK	
D601	0402-000103	DIODE-BRIDGE	D2SBA60,600V,1.5A,SIP-4,ST	
D608	0402-001194	DIODE-RECTIFIER	UG2D,200V,2A,DO-204AC,TP	
D609	0402-000016	DIODE-RECTIFIER	UF5404,400V,3A,DO-201AD,TP	
FBT+H/S	6003-000122	SCREW-TAPTITE	BH,+B,M4,L12,ZPC(YEL),SWRCH18	SNA
FUSE	3601-000004	FUSE-CARTRIDGE	250V,3.15A,SLOW-BLOW,CERAMIC,5x20mm	
HS301_CLAMP1	6502-000001	CABLE CLAMP	DAWH-5NB,D15,L35,NTR,NYLON66	SNA
HS501_CLAMP1	6502-000001	CABLE CLAMP	DAWH-5NB,D15,L35,NTR,NYLON66	SNA
HS501_CLAMP2	6502-000001	CABLE CLAMP	DAWH-5NB,D15,L35,NTR,NYLON66	SNA
IC101	1201-001702	IC-VIDEO AMP	1267,DIP,24P,-,-,10dB,PLASTIC,5.25V,2.4W,0to+70C,-,-,-,-,-,ST	△
IC201	0903-001194	IC-MICROCONTROLLER	3P863,8Bit,SDIP,42P,600MIL,12MHz,ST,CMOS,PLASTIC,5V,-,40to+85C,1040BYTE,48KBYTE	SNA
IC201_SOCKET	3704-001071	SOCKET-IC	42P,DIP,SN,1.778mm	
IC202	1103-001149	IC-EEPROM	524C80D41,4KBit,DIP,8P,300MIL,10mS,5V,10%,PLASTIC,-,25to+70C,10uA,CMOS,ST	
IC401	1204-001509	IC-HOR./VER.PROCESSO	TDA4859,DIP,32P,400MIL,PLASTIC,16V,-,-,20TO+70CC,ST,H/V DEF. PROCESSOR	
L401	BH27-20345B	COIL-CHOK		SNA
L402	BH27-00023A	COIL-CHOK	120UH,+/-10%,DR1523(L-81,C:9.8),BK,-,-	
L403	BH27-20342U	COIL-CHOK	-8.2MH(250KHz),10%,DR8*11,-,-,-,-,10.5OHM,-,-,-,BULK	
L601	BH27-00007A	COIL-LINE FILTER	25MH MIN,-,SOE 2424,BULK,-,-	
LJP1	BH39-40306C	CBF-HARNESS	,60MM,BLK,1015,AWG22,-,-,-,-,-	SNA
LJP2	BH39-40306C	CBF-HARNESS	,60MM,BLK,1015,AWG22,-,-,-,-,-	SNA
LJP3	BH39-40306D	CBF-HARNESS	,80MM,BLK,1015,AWG22,-,-,-,-,-	SNA
LJP4	BH39-40306D	CBF-HARNESS	,80MM,BLK,1015,AWG22,-,-,-,-,-	SNA
LJP5	BH39-40305Z	CBF-HARNESS	,160MM,BLK,1015,AWG22,-,-,-,-,-	SNA
LJP6	BH39-40306D	CBF-HARNESS	,80MM,BLK,1015,AWG22,-,-,-,-,-	SNA
OP201	0601-001147	LED	ROUND,GRN,4.75mm,565nm	SNA
Q409	0505-001309	FET-SILICON	IRF630,N,200V,10A,0.4OHM,100W,TO-220	

7 Electrical Parts List

Loc. No.	Code No.	Description	Specification	Remarks
RL601	3501-001111	RELAY-POWER	12Vdc,250mW,5A,1FormA,15mS,5mS	
S/BTM+PCB	6003-000010	SCREW-TAPTITE	BWH,+B,M3,L10,ZPC(YEL),SWRCH1	SNA
SH/BTM+AC/SOCK	6003-000010	SCREW-TAPTITE	BWH,+B,M3,L10,ZPC(YEL),SWRCH1	SNA
SH/BTM+SH/LMF	6003-000010	SCREW-TAPTITE	BWH,+B,M3,L10,ZPC(YEL),SWRCH1	SNA
SH/BTM+VID/GND	6003-000010	SCREW-TAPTITE	BWH,+B,M3,L10,ZPC(YEL),SWRCH1	SNA
SH/VID	6502-000001	CABLE CLAMP	DAWH-5NB,D15,L35,NTR,NYLON66	SNA
SH/VID+H/S	6003-000010	SCREW-TAPTITE	BWH,+B,M3,L10,ZPC(YEL),SWRCH1	SNA
SH/VIDEO	BH39-00134A	CBF-HARNESS	-,200MM,BLK,UL1015,AWG18,35068-9822/35750-101	
SH/VIDEO	BH39-00150A	CBF-HARNESS	-,150MM,-,8*0.16TA*16,35750-1010	
SH/VIDEO	BH39-00323A	CBF HARNESS	PN15LT,8*0.16TA*16,-,120MM,-,35068-9822,ST710095-3,-,-----	
SIGNAL	BH39-00282A	CBF SIGNAL	PN17L0,15P/06P,07P,20276,1500MM,UL20276,IVORY,D-SUB/MALE,-,--	
SK01	3704-001142	SOCKET-CRT	10P,22.5PI,25.6PI,Ni,-	
SW401	3406-000002	SWITCH-ROTARY	36Vdc,200mA,SP3T,-	
SW601	3403-001116	SWITCH-PUSH	30VDC,0.1A,2C2P,SELF LOCK,-	
T401	BH26-00027A	TRANS-HOR.DRIVE	35.0MH,-,E1 1916,PL-3,-,310UH,-	△
T402	BH26-00028A	TRANS-H.LINEARITY	5.2UH,6P,DR1425(C:5.0),YL-81,5.2UH/68.0MH,-,HL-1425E	
T501	BH26-00109A	TRANS FBT	LC-13,CF1781,PN17L,1.12mH,HV45,FUR3556,375.0mohm,71.0Vdc,14P,-10 -60,BK,27.0KV	△
T502	BH26-00114A	TRANS-FOUCS	EE-1916,PN17L,5P,1.7mH,-,70mH,-,0.85ohm/8.5ohm,-,PL3,DMR30,EE-1916,20uH MAX,	
T601	BH26-00100A	TRANS POWER,(S/W),LAYER TYPE	ER-3541(16P),PN15V0,390uH/82.0uH/37.5uH,16P[ER-3541],-,-,-----,PL3,DMR30,J2A-1	
T602	BH26-30302S	TRANS-SYNC.	3-1(250UH)-,-,SB-5S,UU1116,3-	
TH601	1404-000002	THERMISTOR-PTC	9ohm,20%,-,TR,RECT,-	
TH602	1404-001020	THERMISTOR-NTC	8ohm,15%,-,17mW/C,BK	
VIDEO_CLAMP_3	6502-000127	CABLE CLAMP	DAWH-18NB,I15,-,NTR,NYLON66	SNA
BD101	3301-000011	CORE-FERRITE BEAD	AA,3.5x1.0x5.7mm,1500,2375G	SNA
BD102	3301-000011	CORE-FERRITE BEAD	AA,3.5x1.0x5.7mm,1500,2375G	SNA
BD103	3301-000011	CORE-FERRITE BEAD	AA,3.5x1.0x5.7mm,1500,2375G	SNA
BD104	3301-000011	CORE-FERRITE BEAD	AA,3.5x1.0x5.7mm,1500,2375G	SNA
BD105	3301-000011	CORE-FERRITE BEAD	AA,3.5x1.0x5.7mm,1500,2375G	SNA
BD401	3301-001450	CORE-FERRITE BEAD	AA,45ohm,35x0.6x57mm,50mA,TP,SN-20(ui2000)-	SNA
BD402	3301-000011	CORE-FERRITE BEAD	AA,3.5x1.0x5.7mm,1500,2375G	SNA
BD403	3301-000011	CORE-FERRITE BEAD	AA,3.5x1.0x5.7mm,1500,2375G	SNA
BD600	3301-000011	CORE-FERRITE BEAD	AA,3.5x1.0x5.7mm,1500,2375G	SNA
BD601	3301-000011	CORE-FERRITE BEAD	AA,3.5x1.0x5.7mm,1500,2375G	SNA
BD602	3301-000011	CORE-FERRITE BEAD	AA,3.5x1.0x5.7mm,1500,2375G	SNA
BD603	3301-000011	CORE-FERRITE BEAD	AA,3.5x1.0x5.7mm,1500,2375G	SNA
C101	2201-000285	C-CERAMIC,DISC	1nF,10%,1KV,Y5P,TP,8x5.5	
C102	2301-000148	C-FILM,PEF	10nF,5%,100V,TP,7x3.2x7mm,5mm	
C103	2301-000148	C-FILM,PEF	10nF,5%,100V,TP,7x3.2x7mm,5mm	
C104	2401-000025	C-AL	100uF,20%,16V,GP,TP,6.3x11.5	
C107	2301-000014	C-FILM,PEF	6.8nF,5%,100V,TP,5.8x12.5mm,5m	
C108	2401-001334	C-AL	470nF,20%,50V,GP,TP,5x11,2.5	
C109	2201-000119	C-CERAMIC,DISC	100nF,+80-20%,50V,Y5V,TP,8x3,5	
C110	2201-000119	C-CERAMIC,DISC	100nF,+80-20%,50V,Y5V,TP,8x3,5	
C114	2202-002009	C-CERAMIC,MLC-AXIAL	100nF,+80-20%,50V,Y5V,TP,2.3X3	
C115	2201-000119	C-CERAMIC,DISC	100nF,+80-20%,50V,Y5V,TP,8x3,5	
C116	2401-000025	C-AL	100uF,20%,16V,GP,TP,6.3x11,5	
C117	2202-002009	C-CERAMIC,MLC-AXIAL	100nF,+80-20%,50V,Y5V,TP,2.3X3	
C118	2401-000292	C-AL	100uF,20%,16V,WT,TP,8x11.5mm,5	
C119	2401-000393	C-AL	10uF,20%,100V,WT,TP,8x11.5,5	
C120	2301-000148	C-FILM,PEF	10nF,5%,100V,TP,7x3.2x7mm,5mm	
C121	2201-000285	C-CERAMIC,DISC	1nF,10%,1KV,Y5P,TP,8x5.5	
C122	2301-000010	C-FILM,PEF	100nF,5%,100V,TP,11.5x12.5mm,5	
C123	2202-002009	C-CERAMIC,MLC-AXIAL	100nF,+80-20%,50V,Y5V,TP,2.3X3	
C124	2301-000148	C-FILM,PEF	10nF,5%,100V,TP,7x3.2x7mm,5mm	
C129	2301-000148	C-FILM,PEF	10nF,5%,100V,TP,7x3.2x7mm,5mm	
C201	2401-000025	C-AL	100uF,20%,16V,GP,TP,6.3x11,5	
C202	2201-000389	C-CERAMIC,DISC	0.022nF,5%,50V,NP0,TP,5x3,5	
C203	2201-000389	C-CERAMIC,DISC	0.022nF,5%,50V,NP0,TP,5x3,5	
C204	2401-000603	C-AL	1uF,20%,50V,GP,TP,5x11,5	
C205	2401-000603	C-AL	1uF,20%,50V,GP,TP,5x11,5	
C207	2401-002075	C-AL	4.7uF,20%,50V,GP,TP,5x11,5	

Loc. No.	Code No.	Description	Specification	Remarks
C209	2401-002075	C-AL	4.7uF,20%,50V,GP,TP,5x11,5	
C210	2401-000661	C-AL	2.2uF,20%,50V,GP,TP,5x11,5	
C211	2201-000146	C-CERAMIC,DISC	0.1nF,5%,50V,SL,TP,5x3.5,5	
C212	2201-000017	C-CERAMIC,DISC	1nF,10%,50V,Y5P,TP,5x3.5,5	
C213	2301-000010	C-FILM,PEF	100nF,5%,100V,TP,11.5x12.5mm,5	
C214	2401-000025	C-AL	100uF,20%,16V,GP,TP,6.3x11,5	
C215	2201-000146	C-CERAMIC,DISC	0.1nF,5%,50V,SL,TP,5x3.5,5	
C218	2301-000148	C-FILM,PEF	10nF,5%,100V,TP,7x3.2x7mm,5mm	
C301	2305-000665	C-FILM,MPEF	100nF,5%,63V,TP,7.5x4.0x5.0mm,	
C302	2305-000280	C-FILM,MPEF	220nF,10%,63V,TP,7.5x13.5mm,5m	
C305	2401-001378	C-AL	470uF,20%,16V,WT,TP,10x20,5	
C306	2401-002274	C-AL	220uF,20%,35V,WT,TP,10x12.5,5	
C307	2305-000237	C-FILM,MPEF	1uF,5%,63V,TP,7.5x15.5mm,5mm	
C308	2301-000013	C-FILM,PEF	4.7nF,5%,100V,TP,10.5x12.5x6.5	
C309	2202-002008	C-CERAMIC,MLC-AXIAL	10nF,+80-20%,50V,Y5V,TP,2.3X3.	
C312	2401-000050	C-AL	10uF,20%,16V,GP,TP,5x11,2,5	
C401	2301-000312	C-FILM,PEF	8.2nF,5%,100V,TP,6x12.5mm,5mm	
C402	2201-000119	C-CERAMIC,DISC	100nF,+80-20%,50V,Y5V,TP,8x3,5	
C403	2305-000178	C-FILM,MPEF	10nF,5%,100V,TP,-,5mm	
C404	2301-000312	C-FILM,PEF	8.2nF,5%,100V,TP,6x12.5mm,5mm	
C405	2201-000823	C-CERAMIC,DISC	0.27nF,5%,50V,SL,TP,8x3.5,5	
C406	2301-000519	C-FILM,PEF	3.3nF,5%,100V,TP,5.8x3x12.5,5m	
C407	2401-000540	C-AL	150uF,20%,63V,LZ,TP,10x25,5	
C408	2201-000469	C-CERAMIC,DISC	0.33nF,10%,500V,Y5P,TP,5.5x3,5	
C410	2401-000025	C-AL	100uF,20%,16V,GP,TP,6.3x11,5	
C411	2301-000174	C-FILM,PEF	15nF,5%,100V,TP,7.2x4.0x7.5mm,	
C412	2301-000004	C-FILM,PEF	2.2nF,5%,100V,TP,5.5X10X2,9,5m	
C413	2401-001012	C-AL	3.3UF,20%,50V,BP,TP,16X25,7,5	
C414	2401-001334	C-AL	470nF,20%,50V,GP,TP,5x11,2,5	
C415	2401-001222	C-AL	4.7UF,20%,160V,WT,TP,8X11.5MM,5	
C416	2301-000010	C-FILM,PEF	100nF,5%,100V,TP,11.5x12.5mm,5	
C417	2301-000148	C-FILM,PEF	10nF,5%,100V,TP,7x3.2x7mm,5mm	
C419	2301-001306	C-FILM,PPF	2.5NF,3%,1.6KV,TP,21.5X15.5X8.5MM,7,5	△
C420	2309-000106	C-FILM,MPE-PPF	2.2nF,5%,1.6KV,TP,23x16x9,7,5m	△
C421	2303-000331	C-FILM,PPF	4.7nF,5%,630V,TP,19.5x12x7,7,5	SNA
C423	2401-000613	C-AL	1uF,20%,50V,WT,TP,5x11,5	
C425	2306-000125	C-FILM,MPPF	120nF,5%,250V,TP,19x15x7,7,5mm	
C426	2401-000613	C-AL	1uF,20%,50V,WT,TP,5x11,5	
C427	2306-000137	C-FILM,MPPF	180nF,5%,250V,TP,19x16.5x8,7,5	
C429	2401-000613	C-AL	1uF,20%,50V,WT,TP,5x11,5	
C431	2306-000169	C-FILM,MPPF	250nF,5%,250V,TP,19x18x9,5,7,5	
C433	2305-001003	C-FILM,MPEF	10nF,5%,250V,TP,13x4.5x9mm,7,5	
C434	2401-000050	C-AL	10uF,20%,16V,GP,TP,5x11,2,5	
C436	2201-000469	C-CERAMIC,DISC	0.33nF,10%,500V,Y5P,TP,5.5x3,5	
C437	2401-000025	C-AL	100uF,20%,16V,GP,TP,6.3x11,5	
C439	2202-002008	C-CERAMIC,MLC-AXIAL	10nF,+80-20%,50V,Y5V,TP,2.3X3.	
C500	2401-000603	C-AL	1uF,20%,50V,GP,TP,5x11,5	
C501	2301-000016	C-FILM,PEF	22nF,5%,100V,TP,7.2x4.5x9.0mm,	
C502	2301-000016	C-FILM,PEF	22nF,5%,100V,TP,7.2x4.5x9.0mm,	
C503	2401-000050	C-AL	10uF,20%,16V,GP,TP,5x11,2,5	
C504	2301-000004	C-FILM,PEF	2.2nF,5%,100V,TP,5.5X10X2,9,5m	
C505	2401-000059	C-AL	220nF,20%,50V,GP,-,5x11,5	
C508	2401-002267	C-AL	2.2uF,20%,250V,GP,TP,8x11,5,5	
C509	2401-000043	C-AL	1uF,20%,160V,GP,TP,6.3x11,5	
C510	2301-000294	C-FILM,PEF	56nF,5%,100V,TP,9.5x12.5mm,5mm	
C513	2201-000291	C-CERAMIC,DISC	1nF,10%,500V,Y5P,TP,7.5x3.5,5	
C551	2401-000050	C-AL	10uF,20%,16V,GP,TP,5x11,2,5	
C552	2201-000132	C-CERAMIC,DISC	0.1nF,10%,500V,Y5P,TP,6.5x3,5	
C553	2201-000291	C-CERAMIC,DISC	1nF,10%,500V,Y5P,TP,7.5x3.5,5	
C596	2201-000291	C-CERAMIC,DISC	1nF,10%,500V,Y5P,TP,7.5x3.5,5	
C597	2201-000291	C-CERAMIC,DISC	1nF,10%,500V,Y5P,TP,7.5x3.5,5	

7 Electrical Parts List

Loc. No.	Code No.	Description	Specification	Remarks
C598	2201-000291	C-CERAMIC,DISC	1nF,10%,500V,Y5P,TP,7.5x3.5,5	
C599	2201-000291	C-CERAMIC,DISC	1nF,10% 500V,Y5P,TP,7.5x3.5,5	
C600	2201-002026	C-CERAMIC,DISC	1nF,20%,400VAC,B,TP,11x6,7.5mm	
C603	2201-000024	C-CERAMIC,DISC	4.7nF,20%,250VAC,Y5U,TP,16x7,7	
C604	2201-000024	C-CERAMIC,DISC	4.7nF,20%,250VAC,Y5U,TP,16x7,7	
C607	2202-002009	C-CERAMIC,MLC-AXIAL	100nF,+80-20%,50V,Y5V,TP,2.3X3	
C609	2401-000971	C-AL	22uF,20%,50V,WT,TP,6x11mm,5mm	
C610	2301-000284	C-FILM,PEF	47nF,5%,100V,TP,8.5x12.5mm,5mm	
C611	2401-000613	C-AL	1uF,20%,50V,WT,TP,5x11,5	
C612	2401-000613	C-AL	1uF,20%,50V,WT,TP,5x11,5	
C613	2201-000012	C-CERAMIC,DISC	0.22nF,10%,1kV,Y5P,TP,6.3x5,5	
C614	2201-000019	C-CERAMIC,DISC	10nF,+80-20%,500V,Y5V,TP,13.5x4mm,5	
C615	2201-000291	C-CERAMIC,DISC	1nF,10%,500V,Y5P,TP,7.5x3.5,5	
C616	2201-000023	C-CERAMIC,DISC	2.2nF,20%,125V,Y5U,TP,11x7,5	
C617	2201-000023	C-CERAMIC,DISC	2.2nF,20%,125V,Y5U,TP,11x7,5	
C618	2401-000039	C-AL	1000uF,20%,16V,GP,TP,10x16,5	
C619	2201-000469	C-CERAMIC,DISC	0.33nF,10%,500V,Y5P,TP,5.5x3,5	
C620	2401-000540	C-AL	150uF,20%,63V,LZ,TP,10x25,5	
C621	2401-001551	C-AL	47uF,20%,35V,GP,TP,6.3x11,5	
C622	2401-000151	C-AL	1000uF,20%,25V,GP,TP,10x20,5	
C623	2401-000039	C-AL	1000uF,20%,16V,GP,TP,10x16,5	
C626	2401-000025	C-AL	100uF,20%,16V,GP,TP,6.3x11,5	
C627	2401-000292	C-AL	100uF,20%,16V,WT,TP,8x11.5mm,5	
C628	2401-000050	C-AL	10uF,20%,16V,GP,TP,5x11,2,5	
C629	2401-000292	C-AL	100uF,20%,16V,WT,TP,8x11.5mm,5	
C630	2401-000971	C-AL	22uF,20%,50V,WT,TP,6x11mm,5mm	
C697	2201-000017	C-CERAMIC,DISC	1nF,10%,50V,Y5P,TP,5x3,5,5	
C698	2201-000019	C-CERAMIC,DISC	10nF,+80-20%,500V,Y5V,TP,13.5x4mm,5	
C699	2202-002009	C-CERAMIC,MLC-AXIAL	100nF,+80-20% 50V,Y5V,TP,2.3X3	
CB01	2202-002009	C-CERAMIC,MLC-AXIAL	100nF,+80-20% 50V,Y5V,TP,2.3X3	
CB02	2301-000010	C-FILM,PEF	100nF,5%,100V,TP,11.5x12.5mm,5	
CB03	2201-000119	C-CERAMIC,DISC	100nF,+80-20% 50V,Y5V,TP,8x3,5	
CB04	2305-000004	C-FILM,MPEF	220nF,10%,100V,TP,12.7x16,5mm	
CG01	2202-002009	C-CERAMIC,MLC-AXIAL	100nF,+80-20% 50V,Y5V,TP,2.3X3	
CG02	2301-000010	C-FILM,PEF	100nF,5%,100V,TP,11.5x12.5mm,5	
CG03	2201-000119	C-CERAMIC,DISC	100nF,+80-20% 50V,Y5V,TP,8x3,5	
CG04	2305-000004	C-FILM,MPEF	220nF,10%,100V,TP,12.7x16,5mm	
CN304	3711-000197	CONNECTOR-HEADER	1WALL,3P,1R,2.5mm,STRAIGHT,SN	SNA
CN501	6042-000001	EYELET	ID2.2,OD2.7,L3.1,SN,BSS3-E/EH	SNA
CN603	3711-000217	CONNECTOR-HEADER	1WALL,3P,1R,3.96mm,STRAIGHT,SN	SNA
CR01	2202-002009	C-CERAMIC,MLC-AXIAL	100nF,+80-20% 50V,Y5V,TP,2.3X3	
CR02	2301-000010	C-FILM,PEF	100nF,5%,100V,TP,11.5x12.5mm,5	
CR03	2201-000119	C-CERAMIC,DISC	100nF,+80-20% 50V,Y5V,TP,8x3,5	
CR04	2305-000004	C-FILM,MPEF	220nF,10%,100V,TP,12.7x16,5mm	
D301	0402-000274	DIODE-RECTIFIER	UF4004,400V,1A,DO-41,TP	
D400	0401-000005	DIODE-SWITCHING	1N4148,100V,200mA,DO-35,TP	
D401	0402-000274	DIODE-RECTIFIER	UF4004,400V,1A,DO-41,TP	
D402	0402-000006	DIODE-RECTIFIER	1N4007GP,1000V,1A,DO-41,TP	
D403	0402-000006	DIODE-RECTIFIER	1N4007GP,1000V,1A,DO-41,TP	
D404	0402-000006	DIODE-RECTIFIER	1N4007GP,1000V,1A,DO-41,TP	
D405	0402-000274	DIODE-RECTIFIER	UF4004,400V,1A,DO-41,TP	
D407	0402-000274	DIODE-RECTIFIER	UF4004,400V,1A,DO-41,TP	
D410	0402-000546	DIODE-RECTIFIER	TVR10G,400V,1.0A,DO-41,TP	
D411	0402-000546	DIODE-RECTIFIER	TVR10G,400V,1.0A,DO-41,TP	
D412	0402-000546	DIODE-RECTIFIER	TVR10G,400V,1.0A,DO-41,TP	
D413	0402-000546	DIODE-RECTIFIER	TVR10G,400V,1.0A,DO-41,TP	
D420	0401-000005	DIODE-SWITCHING	1N4148,100V,200mA,DO-35,TP	
D421	0401-000004	DIODE-SWITCHING	1SS244,250V,625mA,DO-34,TP	
D501	0401-000005	DIODE-SWITCHING	1N4148,100V,200mA,DO-35,TP	
D503	0402-000546	DIODE-RECTIFIER	TVR10G,400V,1.0A,DO-41,TP	
D504	0402-000546	DIODE-RECTIFIER	TVR10G,400V,1.0A,DO-41,TP	



Loc. No.	Code No.	Description	Specification	Remarks
D507	0401-000005	DIODE-SWITCHING	1N4148,100V,200mA,DO-35,TP	
D508	0401-000005	DIODE-SWITCHING	1N4148,100V,200mA,DO-35,TP	
D509	0401-000005	DIODE-SWITCHING	1N4148,100V,200mA,DO-35,TP	
D510	0401-000005	DIODE-SWITCHING	1N4148,100V,200mA,DO-35,TP	
D511	0401-000005	DIODE-SWITCHING	1N4148,100V,200mA,DO-35,TP	
D512	0401-000005	DIODE-SWITCHING	1N4148,100V,200mA,DO-35,TP	
D520	0402-000012	DIODE-RECTIFIER	UF4007,1KV,1A,DO-41,TP	
D597	0401-000005	DIODE-SWITCHING	1N4148,100V,200mA,DO-35,TP	
D598	0401-000005	DIODE-SWITCHING	1N4148,100V,200mA,DO-35,TP	
D602	0401-000005	DIODE-SWITCHING	1N4148,100V,200mA,DO-35,TP	
D604	0402-000012	DIODE-RECTIFIER	UF4007,1KV,1A,DO-41,TP	
D605	0402-000012	DIODE-RECTIFIER	UF4007,1KV,1A,DO-41,TP	
D606	0402-000546	DIODE-RECTIFIER	TVR10G,400V,1.0A,DO-41,TP	
D607	0401-000005	DIODE-SWITCHING	1N4148,100V,200mA,DO-35,TP	
D610	0402-000012	DIODE-RECTIFIER	UF4007,1KV,1A,DO-41,TP	
D611	0402-001194	DIODE-RECTIFIER	UG2D,200V,2A,DO-204AC,TP	
D612	0402-000546	DIODE-RECTIFIER	TVR10G,400V,1.0A,DO-41,TP	
D614	0402-000546	DIODE-RECTIFIER	TVR10G,400V,1.0A,DO-41,TP	
D615	0401-000005	DIODE-SWITCHING	1N4148,100V,200mA,DO-35,TP	
D616	0401-000005	DIODE-SWITCHING	1N4148,100V,200mA,DO-35,TP	
D618	0401-000005	DIODE-SWITCHING	1N4148,100V,200mA,DO-35,TP	
DB01	0401-000005	DIODE-SWITCHING	1N4148,100V,200mA,DO-35,TP	
DB02	0401-000005	DIODE-SWITCHING	1N4148,100V,200mA,DO-35,TP	
DB03	0401-000004	DIODE-SWITCHING	1SS244,250V,625mA,DO-34,TP	
DB04	0401-000004	DIODE-SWITCHING	1SS244,250V,625mA,DO-34,TP	
DB05	0401-000005	DIODE-SWITCHING	1N4148,100V,200mA,DO-35,TP	
DG01	0401-000005	DIODE-SWITCHING	1N4148,100V,200mA,DO-35,TP	
DG02	0401-000005	DIODE-SWITCHING	1N4148,100V,200mA,DO-35,TP	
DG03	0401-000004	DIODE-SWITCHING	1SS244,250V,625mA,DO-34,TP	
DG04	0401-000004	DIODE-SWITCHING	1SS244,250V,625mA,DO-34,TP	
DG05	0401-000005	DIODE-SWITCHING	1N4148,100V,200mA,DO-35,TP	
DR01	0401-000005	DIODE-SWITCHING	1N4148,100V,200mA,DO-35,TP	
DR02	0401-000005	DIODE-SWITCHING	1N4148,100V,200mA,DO-35,TP	
DR03	0401-000004	DIODE-SWITCHING	1SS244,250V,625mA,DO-34,TP	
DR04	0401-000004	DIODE-SWITCHING	1SS244,250V,625mA,DO-34,TP	
DR05	0401-000005	DIODE-SWITCHING	1N4148,100V,200mA,DO-35,TP	
EY1	6042-000002	EYELET	ID1.5,OD2,L3.1,SN,BSS3-E/EH	SNA
EY2	6042-000001	EYELET	ID2.2,OD2.7,L3.1,SN,BSS3-E/EH	SNA
EY3	6042-000001	EYELET	ID2.2,OD2.7,L3.1,SN,BSS3-E/EH	SNA
EY301	6042-000001	EYELET	ID2.2,OD2.7,L3.1,SN,BSS3-E/EH	SNA
EY302	6042-000001	EYELET	ID2.2,OD2.7,L3.1,SN,BSS3-E/EH	SNA
EY4	6042-000002	EYELET	ID1.5,OD2,L3.1,SN,BSS3-E/EH	SNA
EY401	6042-000002	EYELET	ID1.5,OD2,L3.1,SN,BSS3-E/EH	SNA
EY444	6042-000002	EYELET	ID1.5,OD2,L3.1,SN,BSS3-E/EH	SNA
EY445	6042-000002	EYELET	ID1.5,OD2,L3.1,SN,BSS3-E/EH	SNA
EY499	6042-000002	EYELET	ID1.5,OD2,L3.1,SN,BSS3-E/EH	SNA
EY501	6042-000001	EYELET	ID2.2,OD2.7,L3.1,SN,BSS3-E/EH	SNA
EY502	6042-000001	EYELET	ID2.2,OD2.7,L3.1,SN,BSS3-E/EH	SNA
EY503	6042-000001	EYELET	ID2.2,OD2.7,L3.1,SN,BSS3-E/EH	SNA
EY504	6042-000002	EYELET	ID1.5,OD2,L3.1,SN,BSS3-E/EH	SNA
EY505	6042-000002	EYELET	ID1.5,OD2,L3.1,SN,BSS3-E/EH	SNA
EY506	6042-000002	EYELET	ID1.5,OD2,L3.1,SN,BSS3-E/EH	SNA
EY507	6042-000002	EYELET	ID1.5,OD2,L3.1,SN,BSS3-E/EH	SNA
EY508	6042-000002	EYELET	ID1.5,OD2,L3.1,SN,BSS3-E/EH	SNA
EY601	6042-000001	EYELET	ID2.2,OD2.7,L3.1,SN,BSS3-E/EH	SNA
EY602	6042-000001	EYELET	ID2.2,OD2.7,L3.1,SN,BSS3-E/EH	SNA
EY603	6042-000001	EYELET	ID2.2,OD2.7,L3.1,SN,BSS3-E/EH	SNA
EY604	6042-000001	EYELET	ID2.2,OD2.7,L3.1,SN,BSS3-E/EH	SNA
EY605	6042-000001	EYELET	ID2.2,OD2.7,L3.1,SN,BSS3-E/EH	SNA
EY606	6042-000001	EYELET	ID2.2,OD2.7,L3.1,SN,BSS3-E/EH	SNA
EY607	6042-000002	EYELET	ID1.5,OD2,L3.1,SN,BSS3-E/EH	SNA

7 Electrical Parts List

Loc. No.	Code No.	Description	Specification	Remarks
EY608	6042-000002	EYELET	ID1.5,OD2,L3.1,SN,BSS3-E/EH	SNA
EY609	6042-000002	EYELET	ID1.5,OD2,L3.1,SN,BSS3-E/EH	SNA
EY610	6042-000002	EYELET	ID1.5,OD2,L3.1,SN,BSS3-E/EH	SNA
EY699	6042-000002	EYELET	ID1.5,OD2,L3.1,SN,BSS3-E/EH	SNA
FH1	3602-000001	FUSE-CLIP	-,30mohm	SNA
G2	BH71-40300A	PIN-HINGE	-,BRASS,D2.36,SN,HEAT/SINK	SNA
GND	BH71-40300A	PIN-HINGE	-,BRASS,D2.36,SN,HEAT/SINK	SNA
GT603	BH71-40300A	PIN-HINGE	-,BRASS,D2.36,SN,HEAT/SINK	SNA
GT604	BH71-40300A	PIN-HINGE	-,BRASS,D2.36,SN,HEAT/SINK	SNA
IC102	BH13-00022A	IC-BIAS CLAMP	LM2480NA,PN15H/17L,8P,0to+70C,DIP,3mA,85V,ST	
IC104	1204-001767	IC-OSD PROCESSOR	S5D2510X02-DOB0,DIP,16P,300MIL,PLASTIC,5.25V,1.2W,-20to+70C,ST,-	
IC603	1201-000229	IC-OP AMP	324,DIP,14P,300MIL,QUAD,100V/m	
J1	BH39-40305U	CBF HARNESS	52MM,AWG22(0.6PI),-,AWG22(0.	SNA
J10	BH39-40305U	CBF HARNESS	52MM,AWG22(0.6PI),-,AWG22(0.	SNA
J14	BH39-40305U	CBF HARNESS	52MM,AWG22(0.6PI),-,AWG22(0.	SNA
J15	BH39-40305U	CBF HARNESS	52MM,AWG22(0.6PI),-,AWG22(0.	SNA
J2	BH39-40305U	CBF HARNESS	52MM,AWG22(0.6PI),-,AWG22(0.	SNA
J23	BH39-40305U	CBF HARNESS	52MM,AWG22(0.6PI),-,AWG22(0.	SNA
J24	BH39-40305U	CBF HARNESS	52MM,AWG22(0.6PI),-,AWG22(0.	SNA
J3	BH39-40305U	CBF HARNESS	52MM,AWG22(0.6PI),-,AWG22(0.	SNA
J4	BH39-40305U	CBF HARNESS	52MM,AWG22(0.6PI),-,AWG22(0.	SNA
J5	BH39-40305U	CBF HARNESS	52MM,AWG22(0.6PI),-,AWG22(0.	SNA
J6	BH39-40305U	CBF HARNESS	52MM,AWG22(0.6PI),-,AWG22(0.	SNA
J7	BH39-40305U	CBF HARNESS	52MM,AWG22(0.6PI),-,AWG22(0.	SNA
J78	BH39-40305U	CBF HARNESS	52MM,AWG22(0.6PI),-,AWG22(0.	SNA
J8	BH39-40305U	CBF HARNESS	52MM,AWG22(0.6PI),-,AWG22(0.	SNA
J9	BH39-40305U	CBF HARNESS	52MM,AWG22(0.6PI),-,AWG22(0.	SNA
JP_DDC1	BH39-40305U	CBF HARNESS	52MM,AWG22(0.6PI),-,AWG22(0.	SNA
JP_DDC2	BH39-40305U	CBF HARNESS	52MM,AWG22(0.6PI),-,AWG22(0.	SNA
JP_DHHS	BH39-40305U	CBF HARNESS	52MM,AWG22(0.6PI),-,AWG22(0.	SNA
JP1	BH39-40305U	CBF HARNESS	52MM,AWG22(0.6PI),-,AWG22(0.	SNA
JP10	BH39-40305U	CBF HARNESS	52MM,AWG22(0.6PI),-,AWG22(0.	SNA
JP11	BH39-40305U	CBF HARNESS	52MM,AWG22(0.6PI),-,AWG22(0.	SNA
JP12	BH39-40305U	CBF HARNESS	52MM,AWG22(0.6PI),-,AWG22(0.	SNA
JP13	BH39-40305U	CBF HARNESS	52MM,AWG22(0.6PI),-,AWG22(0.	SNA
JP14	BH39-40305U	CBF HARNESS	52MM,AWG22(0.6PI),-,AWG22(0.	SNA
JP15	BH39-40305U	CBF HARNESS	52MM,AWG22(0.6PI),-,AWG22(0.	SNA
JP16	BH39-40305U	CBF HARNESS	52MM,AWG22(0.6PI),-,AWG22(0.	SNA
JP17	BH39-40305U	CBF HARNESS	52MM,AWG22(0.6PI),-,AWG22(0.	SNA
JP18	BH39-40305U	CBF HARNESS	52MM,AWG22(0.6PI),-,AWG22(0.	SNA
JP19	BH39-40305U	CBF HARNESS	52MM,AWG22(0.6PI),-,AWG22(0.	SNA
JP2	BH39-40305U	CBF HARNESS	52MM,AWG22(0.6PI),-,AWG22(0.	SNA
JP20	BH39-40305U	CBF HARNESS	52MM,AWG22(0.6PI),-,AWG22(0.	SNA
JP21	BH39-40305U	CBF HARNESS	52MM,AWG22(0.6PI),-,AWG22(0.	SNA
JP22	BH39-40305U	CBF HARNESS	52MM,AWG22(0.6PI),-,AWG22(0.	SNA
JP23	BH39-40305U	CBF HARNESS	52MM,AWG22(0.6PI),-,AWG22(0.	SNA
JP24	BH39-40305U	CBF HARNESS	52MM,AWG22(0.6PI),-,AWG22(0.	SNA
JP25	BH39-40305U	CBF HARNESS	52MM,AWG22(0.6PI),-,AWG22(0.	SNA
JP26	BH39-40305U	CBF HARNESS	52MM,AWG22(0.6PI),-,AWG22(0.	SNA
JP27	BH39-40305U	CBF HARNESS	52MM,AWG22(0.6PI),-,AWG22(0.	SNA
JP28	BH39-40305U	CBF HARNESS	52MM,AWG22(0.6PI),-,AWG22(0.	SNA
JP29	BH39-40305U	CBF HARNESS	52MM,AWG22(0.6PI),-,AWG22(0.	SNA
JP3	BH39-40305U	CBF HARNESS	52MM,AWG22(0.6PI),-,AWG22(0.	SNA
JP30	BH39-40305U	CBF HARNESS	52MM,AWG22(0.6PI),-,AWG22(0.	SNA
JP31	BH39-40305U	CBF HARNESS	52MM,AWG22(0.6PI),-,AWG22(0.	SNA
JP32	BH39-40305U	CBF HARNESS	52MM,AWG22(0.6PI),-,AWG22(0.	SNA
JP33	BH39-40305U	CBF HARNESS	52MM,AWG22(0.6PI),-,AWG22(0.	SNA
JP34	BH39-40305U	CBF HARNESS	52MM,AWG22(0.6PI),-,AWG22(0.	SNA
JP35	BH39-40305U	CBF HARNESS	52MM,AWG22(0.6PI),-,AWG22(0.	SNA
JP36	BH39-40305U	CBF HARNESS	52MM,AWG22(0.6PI),-,AWG22(0.	SNA
JP37	BH39-40305U	CBF HARNESS	52MM,AWG22(0.6PI),-,AWG22(0.	SNA

Loc. No.	Code No.	Description	Specification	Remarks
JP38	BH39-40305U	CBF HARNESS	52MM,AWG22(0.6PI),-,AWG22(0.	SNA
JP39	BH39-40305U	CBF HARNESS	52MM,AWG22(0.6PI),-,AWG22(0.	SNA
JP4	BH39-40305U	CBF HARNESS	52MM,AWG22(0.6PI),-,AWG22(0.	SNA
JP40	BH39-40305U	CBF HARNESS	52MM,AWG22(0.6PI),-,AWG22(0.	SNA
JP41	BH39-40305U	CBF HARNESS	52MM,AWG22(0.6PI),-,AWG22(0.	SNA
JP42	BH39-40305U	CBF HARNESS	52MM,AWG22(0.6PI),-,AWG22(0.	SNA
JP43	BH39-40305U	CBF HARNESS	52MM,AWG22(0.6PI),-,AWG22(0.	SNA
JP44	BH39-40305U	CBF HARNESS	52MM,AWG22(0.6PI),-,AWG22(0.	SNA
JP45	BH39-40305U	CBF HARNESS	52MM,AWG22(0.6PI),-,AWG22(0.	SNA
JP46	BH39-40305U	CBF HARNESS	52MM,AWG22(0.6PI),-,AWG22(0.	SNA
JP47	BH39-40305U	CBF HARNESS	52MM,AWG22(0.6PI),-,AWG22(0.	SNA
JP48	BH39-40305U	CBF HARNESS	52MM,AWG22(0.6PI),-,AWG22(0.	SNA
JP49	BH39-40305U	CBF HARNESS	52MM,AWG22(0.6PI),-,AWG22(0.	SNA
JP5	BH39-40305U	CBF HARNESS	52MM,AWG22(0.6PI),-,AWG22(0.	SNA
JP50	BH39-40305U	CBF HARNESS	52MM,AWG22(0.6PI),-,AWG22(0.	SNA
JP51	BH39-40305U	CBF HARNESS	52MM,AWG22(0.6PI),-,AWG22(0.	SNA
JP52	BH39-40305U	CBF HARNESS	52MM,AWG22(0.6PI),-,AWG22(0.	SNA
JP53	BH39-40305U	CBF HARNESS	52MM,AWG22(0.6PI),-,AWG22(0.	SNA
JP54	BH39-40305U	CBF HARNESS	52MM,AWG22(0.6PI),-,AWG22(0.	SNA
JP55	BH39-40305U	CBF HARNESS	52MM,AWG22(0.6PI),-,AWG22(0.	SNA
JP56	BH39-40305U	CBF HARNESS	52MM,AWG22(0.6PI),-,AWG22(0.	SNA
JP57	BH39-40305U	CBF HARNESS	52MM,AWG22(0.6PI),-,AWG22(0.	SNA
JP58	BH39-40305U	CBF HARNESS	52MM,AWG22(0.6PI),-,AWG22(0.	SNA
JP59	BH39-40305U	CBF HARNESS	52MM,AWG22(0.6PI),-,AWG22(0.	SNA
JP6	BH39-40305U	CBF HARNESS	52MM,AWG22(0.6PI),-,AWG22(0.	SNA
JP60	BH39-40305U	CBF HARNESS	52MM,AWG22(0.6PI),-,AWG22(0.	SNA
JP61	BH39-40305U	CBF HARNESS	52MM,AWG22(0.6PI),-,AWG22(0.	SNA
JP62	BH39-40305U	CBF HARNESS	52MM,AWG22(0.6PI),-,AWG22(0.	SNA
JP63	BH39-40305U	CBF HARNESS	52MM,AWG22(0.6PI),-,AWG22(0.	SNA
JP64	BH39-40305U	CBF HARNESS	52MM,AWG22(0.6PI),-,AWG22(0.	SNA
JP65	BH39-40305U	CBF HARNESS	52MM,AWG22(0.6PI),-,AWG22(0.	SNA
JP66	BH39-40305U	CBF HARNESS	52MM,AWG22(0.6PI),-,AWG22(0.	SNA
JP67	BH39-40305U	CBF HARNESS	52MM,AWG22(0.6PI),-,AWG22(0.	SNA
JP68	BH39-40305U	CBF HARNESS	52MM,AWG22(0.6PI),-,AWG22(0.	SNA
JP69	BH39-40305U	CBF HARNESS	52MM,AWG22(0.6PI),-,AWG22(0.	SNA
JP7	BH39-40305U	CBF HARNESS	52MM,AWG22(0.6PI),-,AWG22(0.	SNA
JP70	BH39-40305U	CBF HARNESS	52MM,AWG22(0.6PI),-,AWG22(0.	SNA
JP71	BH39-40305U	CBF HARNESS	52MM,AWG22(0.6PI),-,AWG22(0.	SNA
JP72	BH39-40305U	CBF HARNESS	52MM,AWG22(0.6PI),-,AWG22(0.	SNA
JP73	BH39-40305U	CBF HARNESS	52MM,AWG22(0.6PI),-,AWG22(0.	SNA
JP74	BH39-40305U	CBF HARNESS	52MM,AWG22(0.6PI),-,AWG22(0.	SNA
JP75	BH39-40305U	CBF HARNESS	52MM,AWG22(0.6PI),-,AWG22(0.	SNA
JP76	BH39-40305U	CBF HARNESS	52MM,AWG22(0.6PI),-,AWG22(0.	SNA
JP77	BH39-40305U	CBF HARNESS	52MM,AWG22(0.6PI),-,AWG22(0.	SNA
JP79	BH39-40305U	CBF HARNESS	52MM,AWG22(0.6PI),-,AWG22(0.	SNA
JP8	BH39-40305U	CBF HARNESS	52MM,AWG22(0.6PI),-,AWG22(0.	SNA
JP80	BH39-40305U	CBF HARNESS	52MM,AWG22(0.6PI),-,AWG22(0.	SNA
JP81	BH39-40305U	CBF HARNESS	52MM,AWG22(0.6PI),-,AWG22(0.	SNA
JP83	BH39-40305U	CBF HARNESS	52MM,AWG22(0.6PI),-,AWG22(0.	SNA
JP9	BH39-40305U	CBF HARNESS	52MM,AWG22(0.6PI),-,AWG22(0.	SNA
L403	BH27-20343H	COIL-PEAKING	2.7MH,10%,DR8*8,TP,-,-	SNA
LB02	2701-000319	INDUCTOR-AXIAL	470nH,20%,3x7mm	
LG02	2701-000319	INDUCTOR-AXIAL	470nH,20%,3x7mm	
LR02	2701-000319	INDUCTOR-AXIAL	470nH,20%,3x7mm	
MP1.0	BH41-00125A	PCB MAIN	PN17L*,FR1,1,-,1.6T,247*247,-,-,-	
Q101	0501-000404	TR-SMALL SIGNAL	KSD1616-Y,NPN,750mW,TO-92,TP,135-270	
Q301	0501-000122	TR-SMALL SIGNAL	2N3904,NPN,625mW,TO-92,TP,100-300	
Q302	0501-000581	TR-SMALL SIGNAL	2N3906,PNP,625mW,TO-92,TP,100-300	
Q401	0501-000122	TR-SMALL SIGNAL	2N3904,NPN,625mW,TO-92,TP,100-300	
Q403	0501-000372	TR-SMALL SIGNAL	KSC2383-Y,NPN,900000mW,TO-92L,TP,160-320	
Q405	0501-000303	TR-SMALL SIGNAL	KSA733,PNP,250mW,TO-92,TP,120-240	

7 Electrical Parts List

Loc. No.	Code No.	Description	Specification	Remarks
Q406	0501-000303	TR-SMALL SIGNAL	KSA733,PNP,250mW,TO-92,TP,120-240	
Q407	0501-000140	TR-SMALL SIGNAL	2N5551,NPN,625mW,TO-92,TP,80-250	
Q412	0501-000122	TR-SMALL SIGNAL	2N3904,NPN,625mW,TO-92,TP,100-300	
Q413	0501-000581	TR-SMALL SIGNAL	2N3906,PNP,625mW,TO-92,TP,100-300	
Q414	0501-000586	TR-SMALL SIGNAL	KSC945,NPN,250mW,TO-92,TP,120-240	
Q415	0501-000586	TR-SMALL SIGNAL	KSC945,NPN,250mW,TO-92,TP,120-240	
Q416	0501-000586	TR-SMALL SIGNAL	KSC945,NPN,250mW,TO-92,TP,120-240	
Q501	0501-000586	TR-SMALL SIGNAL	KSC945,NPN,250mW,TO-92,TP,120-240	
Q502	0501-000143	TR-SMALL SIGNAL	2N6520,PNP,625mW,TO-92,TP,30-200	
Q551	0501-000413	TR-SMALL SIGNAL	KSP44,NPN,625mW,TO-92,TP,50-200	
Q601	0501-000586	TR-SMALL SIGNAL	KSC945,NPN,250mW,TO-92,TP,120-240	
Q602	0501-000122	TR-SMALL SIGNAL	2N3904,NPN,625mW,TO-92,TP,100-300	
Q604	0501-000404	TR-SMALL SIGNAL	KSD1616-Y,NPN,750mW,TO-92,TP,135-270	
Q608	0501-000010	TR-SMALL SIGNAL	KSC1008,NPN,800mW,TO-92,TP,120-240	
Q609	0501-002228	TR-SMALL SIGNAL	KTA1281,PNP,1000mW,TO-92L,TP,120-240	
Q610	0501-000586	TR-SMALL SIGNAL	KSC945,NPN,250mW,TO-92,TP,120-240	
Q611	0501-002228	TR-SMALL SIGNAL	KTA1281,PNP,1000mW,TO-92L,TP,120-240	
Q612	0501-000586	TR-SMALL SIGNAL	KSC945,NPN,250mW,TO-92,TP,120-240	
Q614	0501-000404	TR-SMALL SIGNAL	KSD1616-Y,NPN,750mW,TO-92,TP,135-270	
Q615	0501-000581	TR-SMALL SIGNAL	2N3906,PNP,625mW,TO-92,TP,100-300	
R100	2001-000241	R-CARBON	1.5KOHM,5%,1/8W,AA,TP,1.8X3.2MM	
R101	2001-001138	R-CARBON(S)	390OHM,5%,1/2W,AA,TP,2.4X6.4MM	
R102	2001-000429	R-CARBON	1KOHM,5%,1/8W,AA,TP,1.8X3.2MM	
R104	2001-000273	R-CARBON	100KOHM,5%,1/8W,AA,TP,1.8X3.2MM	
R105	2001-000429	R-CARBON	1KOHM,5%,1/8W,AA,TP,1.8X3.2MM	
R106	2001-000290	R-CARBON	10KOHM,5%,1/8W,AA,TP,1.8X3.2MM	
R107	2001-000281	R-CARBON	100OHM,5%,1/8W,AA,TP,1.8X3.2MM	
R108	2001-000281	R-CARBON	100OHM,5%,1/8W,AA,TP,1.8X3.2MM	
R109	2001-000734	R-CARBON	4.7KOHM,5%,1/8W,AA,TP,1.8X3.2MM	
R110	2001-000003	R-CARBON	330ohm,5%,1/8W,AA,TP,1.8x3.2mm	
R111	2001-000003	R-CARBON	330ohm,5%,1/8W,AA,TP,1.8x3.2mm	
R114	2001-000290	R-CARBON	10KOHM,5%,1/8W,AA,TP,1.8X3.2MM	
R115	2001-000331	R-CARBON	12KOHM,5%,1/8W,AA,TP,1.8X3.2MM	
R116	2001-000812	R-CARBON	5.6KOHM,5%,1/8W,AA,TP,1.8X3.2MM	
R117	2001-000290	R-CARBON	10KOHM,5%,1/8W,AA,TP,1.8X3.2MM	
R118	2001-000734	R-CARBON	4.7KOHM,5%,1/8W,AA,TP,1.8X3.2MM	
R119	2001-000003	R-CARBON	330ohm,5%,1/8W,AA,TP,1.8x3.2mm	
R120	2001-000429	R-CARBON	1KOHM,5%,1/8W,AA,TP,1.8X3.2MM	
R121	2001-001138	R-CARBON(S)	390OHM,5%,1/2W,AA,TP,2.4X6.4MM	
R125	2001-000890	R-CARBON	6.8KOHM,5%,1/8W,AA,TP,1.8X3.2MM	
R200	2001-000869	R-CARBON	56OHM,5%,1/8W,AA,TP,1.8X3.2MM	
R201	2001-000812	R-CARBON	5.6KOHM,5%,1/8W,AA,TP,1.8X3.2MM	
R202	2001-000290	R-CARBON	10KOHM,5%,1/8W,AA,TP,1.8X3.2MM	
R203	2001-000008	R-CARBON	15KOHM,5%,1/8W,AA,TP,1.8X3.2MM	
R204	2001-000008	R-CARBON	15KOHM,5%,1/8W,AA,TP,1.8X3.2MM	
R206	2001-000008	R-CARBON	15KOHM,5%,1/8W,AA,TP,1.8X3.2MM	
R207	2001-000869	R-CARBON	56OHM,5%,1/8W,AA,TP,1.8X3.2MM	
R208	2001-000869	R-CARBON	56OHM,5%,1/8W,AA,TP,1.8X3.2MM	
R209	2001-000290	R-CARBON	10KOHM,5%,1/8W,AA,TP,1.8X3.2MM	
R210	2001-000290	R-CARBON	10KOHM,5%,1/8W,AA,TP,1.8X3.2MM	
R211	2001-000660	R-CARBON	33KOHM,5%,1/8W,AA,TP,1.8X3.2MM	
R212	2004-000796	R-METAL	33Kohm,1%,1/4W,AA,TP,2.4x6.4mm	△
R213	2001-000429	R-CARBON	1KOHM,5%,1/8W,AA,TP,1.8X3.2MM	△
R214	2001-000429	R-CARBON	1KOHM,5%,1/8W,AA,TP,1.8X3.2MM	
R215	2001-000281	R-CARBON	100OHM,5%,1/8W,AA,TP,1.8X3.2MM	
R216	2001-000281	R-CARBON	100OHM,5%,1/8W,AA,TP,1.8X3.2MM	
R217	2001-000281	R-CARBON	100OHM,5%,1/8W,AA,TP,1.8X3.2MM	
R218	2001-000281	R-CARBON	100OHM,5%,1/8W,AA,TP,1.8X3.2MM	
R219	2001-000290	R-CARBON	10KOHM,5%,1/8W,AA,TP,1.8X3.2MM	
R220	2001-000281	R-CARBON	100OHM,5%,1/8W,AA,TP,1.8X3.2MM	

Loc. No.	Code No.	Description	Specification	Remarks
R221	2001-000734	R-CARBON	4.7KOHM,5%,1/8W,AA,TP,1.8X3.2MM	
R222	2001-000734	R-CARBON	4.7KOHM,5%,1/8W,AA,TP,1.8X3.2MM	
R223	2001-000005	R-CARBON	390ohm,5%,1/8W,AA,TP,1.8x3.2mm	
R224	2001-000869	R-CARBON	56OHM,5%,1/8W,AA,TP,1.8X3.2MM	
R225	2001-000869	R-CARBON	56OHM,5%,1/8W,AA,TP,1.8X3.2MM	
R229	2001-000281	R-CARBON	100OHM,5%,1/8W,AA,TP,1.8X3.2MM	
R230	2001-000290	R-CARBON	10KOHM,5%,1/8W,AA,TP,1.8X3.2MM	
R236	2001-000290	R-CARBON	10KOHM,5%,1/8W,AA,TP,1.8X3.2MM	
R240	2001-000221	R-CARBON	1.2KOHM,5%,1/8W,AA,TP,1.8X3.2MM	
R299	2001-000034	R-CARBON	220OHM,5%,1/4W,AA,TP,2.4X6.4MM	
R301	2001-000869	R-CARBON	56OHM,5%,1/8W,AA,TP,1.8X3.2MM	
R302	2004-000580	R-METAL	22Kohm,1%,1/4W,AA,TP,2.4x6.4mm	
R303	2001-000890	R-CARBON	6.8KOHM,5%,1/8W,AA,TP,1.8X3.2MM	
R304	2001-000890	R-CARBON	6.8KOHM,5%,1/8W,AA,TP,1.8X3.2MM	
R306	2004-001022	R-METAL	5.6Kohm,1%,1/4W,AA,TP,2.4x6.4m	
R307	2001-001053	R-CARBON(S)	1.5OHM,5%,1/2W,AA,TP,2.4X6.4MM	
R308	2001-001088	R-CARBON(S)	1KOHM,5%,1/2W,AA,TP,2.4X6.4MM	
R309	2004-004014	R-METAL	2.4ohm,1%,1/4W,AA,TP,2.4x6.4mm	
R310	2004-001136	R-METAL	6.8Kohm,1%,1/4W,AA,TP,2.4x6.4m	
R311	2001-000890	R-CARBON	6.8KOHM,5%,1/8W,AA,TP,1.8X3.2MM	
R312	2001-000812	R-CARBON	5.6KOHM,5%,1/8W,AA,TP,1.8X3.2MM	
R315	2004-004014	R-METAL	2.4ohm,1%,1/4W,AA,TP,2.4x6.4mm	
R316	2001-000281	R-CARBON	100OHM,5%,1/8W,AA,TP,1.8X3.2MM	
R323	2001-000290	R-CARBON	10KOHM,5%,1/8W,AA,TP,1.8X3.2MM	
R324	2001-000878	R-CARBON	6.2KOHM,5%,1/8W,AA,TP,1.8X3.2MM	
R402	2001-000869	R-CARBON	56OHM,5%,1/8W,AA,TP,1.8X3.2MM	
R403	2004-001226	R-METAL	750ohm,1%,1/4W,AA,TP,2.4x6.4mm	
R404	2004-000498	R-METAL	2.7Kohm,1%,1/4W,AA,TP,2.4x6.4m	
R405	2001-000591	R-CARBON	3.3KOHM,5%,1/8W,AA,TP,1.8X3.2MM	
R406	2001-000522	R-CARBON	22KOHM,5%,1/8W,AA,TP,1.8X3.2MM	
R407	2001-000109	R-CARBON(S)	470OHM,5%,1/2W,AA,TP,2.4X6.4MM	
R408	2001-000429	R-CARBON	1KOHM,5%,1/8W,AA,TP,1.8X3.2MM	
R409	2001-000812	R-CARBON	5.6KOHM,5%,1/8W,AA,TP,1.8X3.2MM	
R410	2003-000650	R-METAL OXIDE(S)	330ohm,5%,2W,AA,TP,4x12mm	
R412	2001-000290	R-CARBON	10KOHM,5%,1/8W,AA,TP,1.8X3.2MM	△
R413	2001-001038	R-CARBON(S)	0.56OHM,5%,1/2W,AA,TP,2.4X6.4MM	△
R414	2001-001038	R-CARBON(S)	0.56OHM,5%,1/2W,AA,TP,2.4X6.4MM	△
R415	2003-000432	R-METAL OXIDE(S)	1.5Kohm,5%,3W,AA,TP,6x16mm	
R416	2001-000107	R-CARBON(S)	150KOHM,5%,1/2W,AA,TP,2.4X6.4MM	
R417	2001-000290	R-CARBON	10KOHM,5%,1/8W,AA,TP,1.8X3.2MM	
R418	2001-000221	R-CARBON	1.2KOHM,5%,1/8W,AA,TP,1.8X3.2MM	
R419	2001-000397	R-CARBON	180KOHM,5%,1/8W,AA,TP,1.8X3.2MM	
R420	2001-000354	R-CARBON	150KOHM,5%,1/4W,AA,TP,2.4X6.4MM	
R422	2001-001006	R-CARBON	82OHM,5%,1/8W,AA,TP,1.8X3.2MM	
R423	2001-000258	R-CARBON	1.8KOHM,5%,1/8W,AA,TP,1.8X3.2MM	
R424	2004-000216	R-METAL	10Kohm,1%,1/4W,AA,TP,2.4x6.4mm	
R425	2001-000044	R-CARBON	1.2KOHM,5%,1/4W,AA,TP,2.4X6.4MM	
R426	2001-000110	R-CARBON	10OHM,5%,1/4W,AA,TP,2.4X6.4MM	
R427	2001-000429	R-CARBON	1KOHM,5%,1/8W,AA,TP,1.8X3.2MM	
R428	2003-000653	R-METAL OXIDE(S)	330ohm,5%,3W,AA,TP,6x16mm	
R429	2001-000319	R-CARBON	120KOHM,5%,1/8W,AA,TP,1.8X3.2MM	
R430	2001-001078	R-CARBON(S)	15KOHM,5%,1/2W,AA,TP,2.4X6.4MM	
R431	2003-000407	R-METAL OXIDE(S)	0.6ohm,5%,2W,AA,TP,4x12mm	
R432	2001-000020	R-CARBON(S)	220HM,5%,1/2W,AA,TP,2.4X6.4MM	
R434	2001-000449	R-CARBON	2.2KOHM,5%,1/8W,AA,TP,1.8X3.2MM	
R435	2001-000786	R-CARBON	47KOHM,5%,1/8W,AA,TP,1.8X3.2MM	
R436	2001-000449	R-CARBON	2.2KOHM,5%,1/8W,AA,TP,1.8X3.2MM	
R437	2001-000786	R-CARBON	47KOHM,5%,1/8W,AA,TP,1.8X3.2MM	
R438	2001-000449	R-CARBON	2.2KOHM,5%,1/8W,AA,TP,1.8X3.2MM	
R439	2001-000786	R-CARBON	47KOHM,5%,1/8W,AA,TP,1.8X3.2MM	
R440	2001-000290	R-CARBON	10KOHM,5%,1/8W,AA,TP,1.8X3.2MM	

7 Electrical Parts List

Loc. No.	Code No.	Description	Specification	Remarks
R441	2001-000290	R-CARBON	10KOHM,5%,1/8W,AA,TP,1.8X3.2MM	
R443	2003-000650	R-METAL OXIDE(S)	330ohm,5%,2W,AA,TP,4x12mm	
R444	2003-000769	R-METAL OXIDE(S)	680ohm,5%,3W,AA,TP,6x16mm	
R445	2001-000019	R-CARBON(S)	100HM,5%,1/2W,AA,TP,2.4X6.4MM	
R446	2001-000117	R-CARBON(S)	680HM,5%,1/2W,AA,TP,2.4X6.4MM	
R450	2001-000786	R-CARBON	47KOHM,5%,1/8W,AA,TP,1.8X3.2MM	△
R451	2001-000290	R-CARBON	10KOHM,5%,1/8W,AA,TP,1.8X3.2MM	
R452	2001-000290	R-CARBON	10KOHM,5%,1/8W,AA,TP,1.8X3.2MM	
R453	2001-000290	R-CARBON	10KOHM,5%,1/8W,AA,TP,1.8X3.2MM	
R454	2003-000650	R-METAL OXIDE(S)	330ohm,5%,2W,AA,TP,4x12mm	
R455	2001-000211	R-CARBON	10HM,5%,1/4W,AA,TP,2.4X6.4MM	
R500	2001-000435	R-CARBON	1MOHM,5%,1/8W,AA,TP,1.8X3.2MM	△
R501	2001-000890	R-CARBON	6.8KOHM,5%,1/8W,AA,TP,1.8X3.2MM	
R502	2004-000979	R-METAL	47Kohm,1%,1/4W,AA,TP,2.4x6.4mm	△
R504	2001-000008	R-CARBON	15KOHM,5%,1/8W,AA,TP,1.8X3.2MM	△
R505	2001-000924	R-CARBON	680OHM,5%,1/8W,AA,TP,1.8X3.2MM	△
R506	2004-000657	R-METAL	27Kohm,1%,1/4W,AA,TP,2.4x6.4mm	△
R507	2004-000216	R-METAL	10Kohm,1%,1/4W,AA,TP,2.4x6.4mm	
R508	2001-001129	R-CARBON(S)	330KOHM,5%,1/2W,AA,TP,2.4X6.4MM	
R509	2001-001129	R-CARBON(S)	330KOHM,5%,1/2W,AA,TP,2.4X6.4MM	
R510	2001-000837	R-CARBON	51KOHM,5%,1/8W,AA,TP,1.8X3.2MM	△
R511	2001-000478	R-CARBON	2.7OHM,5%,1/4W,AA,TP,2.4X6.4MM	△
R513	2004-001349	R-METAL	91Kohm,1%,1/4W,AA,TP,2.4x6.4mm	
R514	2001-001071	R-CARBON(S)	12KOHM,5%,1/2W,AA,TP,2.4X6.4MM	
R516	2001-001108	R-CARBON(S)	22KOHM,5%,1/2W,AA,TP,2.4X6.4MM	
R518	2001-001108	R-CARBON(S)	22KOHM,5%,1/2W,AA,TP,2.4X6.4MM	
R521	2001-001129	R-CARBON(S)	330KOHM,5%,1/2W,AA,TP,2.4X6.4MM	
R524	2001-000660	R-CARBON	33KOHM,5%,1/8W,AA,TP,1.8X3.2MM	
R525	2001-000273	R-CARBON	100KOHM,5%,1/8W,AA,TP,1.8X3.2MM	
R526	2001-000702	R-CARBON	39KOHM,5%,1/8W,AA,TP,1.8X3.2MM	△
R527	2001-000356	R-CARBON	150KOHM,5%,1/8W,AA,TP,1.8X3.2MM	
R529	2001-000429	R-CARBON	1KOHM,5%,1/8W,AA,TP,1.8X3.2MM	△
R531	2001-000786	R-CARBON	47KOHM,5%,1/8W,AA,TP,1.8X3.2MM	
R551	2001-000530	R-CARBON	240KOHM,5%,1/4W,AA,TP,2.4X6.4MM	
R552	2001-000537	R-CARBON	24KOHM,5%,1/4W,AA,TP,2.4X6.4MM	
R553	2001-001129	R-CARBON(S)	330KOHM,5%,1/2W,AA,TP,2.4X6.4MM	
R554	2001-000087	R-CARBON(S)	120KOHM,5%,1/2W,AA,TP,2.4X6.4MM	
R555	2001-000042	R-CARBON	1KOHM,5%,1/4W,AA,TP,2.4X6.4MM	
R556	2001-000890	R-CARBON	6.8KOHM,5%,1/8W,AA,TP,1.8X3.2MM	
R557	2001-000087	R-CARBON(S)	120KOHM,5%,1/2W,AA,TP,2.4X6.4MM	
R598	2001-000290	R-CARBON	10KOHM,5%,1/8W,AA,TP,1.8X3.2MM	
R599	2001-000958	R-CARBON	750OHM,5%,1/8W,AA,TP,1.8X3.2MM	△
R600	2001-001129	R-CARBON(S)	330KOHM,5%,1/2W,AA,TP,2.4X6.4MM	
R601	2001-001129	R-CARBON(S)	330KOHM,5%,1/2W,AA,TP,2.4X6.4MM	
R602	2001-000023	R-CARBON	47OHM,5%,1/4W,AA,TP,2.4X6.4MM	
R603	2001-000290	R-CARBON	10KOHM,5%,1/8W,AA,TP,1.8X3.2MM	
R604	2001-000857	R-CARBON	560OHM,5%,1/8W,AA,TP,1.8X3.2MM	
R605	2001-000734	R-CARBON	4.7KOHM,5%,1/8W,AA,TP,1.8X3.2MM	
R606	2003-000014	R-METAL OXIDE(S)	10Kohm,5%,3W,AA,TP,6x16mm	
R608	2001-000281	R-CARBON	100OHM,5%,1/8W,AA,TP,1.8X3.2MM	△
R609	2002-001068	R-COMPOSITION	180Kohm,5%,1/2W,AA,TP,3.9x9mm	
R610	2002-001068	R-COMPOSITION	180Kohm,5%,1/2W,AA,TP,3.9x9mm	
R611	2001-000376	R-CARBON	150HM,5%,1/8W,AA,TP,1.8X3.2MM	
R612	2003-000738	R-METAL OXIDE(S)	56Kohm,5%,2W,AA,TP,4x12mm	
R614	2001-001107	R-CARBON(S)	220ohm,5%,1/2W,AA,TP,2.4x6.4mm	
R615	2001-001088	R-CARBON(S)	1KOHM,5%,1/2W,AA,TP,2.4X6.4MM	
R617	2001-001037	R-CARBON(S)	0.390HM,5%,1/2W,AA,TP,2.4X6.4MM	
R618	2001-000429	R-CARBON	1KOHM,5%,1/8W,AA,TP,1.8X3.2MM	
R619	2003-000471	R-METAL OXIDE(S)	10ohm,5%,2W,AA,TP,4x12mm	
R621	2001-000071	R-CARBON	22KOHM,5%,1/4W,AA,TP,2.4X6.4MM	
R622	2001-000016	R-CARBON(S)	1OHM,5%,1/2W,AA,TP,2.4X6.4MM	

Loc. No.	Code No.	Description	Specification	Remarks
R625	2001-000515	R-CARBON	220OHM,5%,1/8W,AA,TP,1.8X3.2MM	
R630	2001-000786	R-CARBON	47KOHM,5%,1/8W,AA,TP,1.8X3.2MM	
R631	2001-001088	R-CARBON(S)	1KOHM,5%,1/2W,AA,TP,2.4X6.4MM	
R632	2001-000290	R-CARBON	10KOHM,5%,1/8W,AA,TP,1.8X3.2MM	
R633	2001-000211	R-CARBON	10HM,5%,1/4W,AA,TP,2.4X6.4MM	
R641	2003-000744	R-METAL OXIDE(S)	56ohm,5%,2W,AA,TP,4x12mm	
R642	2001-000290	R-CARBON	10KOHM,5%,1/8W,AA,TP,1.8X3.2MM	
R660	2001-000290	R-CARBON	10KOHM,5%,1/8W,AA,TP,1.8X3.2MM	
R661	2001-000527	R-CARBON	220HM,5%,1/8W,AA,TP,1.8X3.2MM	
RB01	2001-000969	R-CARBON	750HM,5%,1/8W,AA,TP,1.8X3.2MM	
RB02	2001-000666	R-CARBON	330HM,5%,1/8W,AA,TP,1.8X3.2MM	
RB04	2001-000003	R-CARBON	330ohm,5%,1/8W,AA,TP,1.8x3.2mm	
RB05	2001-000645	R-CARBON	330KOHM,5%,1/8W,AA,TP,1.8X3.2MM	
RB06	2001-000449	R-CARBON	2.2KOHM,5%,1/8W,AA,TP,1.8X3.2MM	
RB07	2001-000705	R-CARBON	390HM,5%,1/2W,AA,TP,3.3X9MM	
RB08	2001-000025	R-CARBON	750HM,5%,1/4W,AA,TP,2.4X6.4MM	
RB09	2001-000290	R-CARBON	10KOHM,5%,1/8W,AA,TP,1.8X3.2MM	
RG01	2001-000969	R-CARBON	750HM,5%,1/8W,AA,TP,1.8X3.2MM	
RG02	2001-000666	R-CARBON	330HM,5%,1/8W,AA,TP,1.8X3.2MM	
RG04	2001-000003	R-CARBON	330ohm,5%,1/8W,AA,TP,1.8x3.2mm	
RG05	2001-000645	R-CARBON	330KOHM,5%,1/8W,AA,TP,1.8X3.2MM	
RG06	2001-000449	R-CARBON	2.2KOHM,5%,1/8W,AA,TP,1.8X3.2MM	
RG07	2001-000705	R-CARBON	390HM,5%,1/2W,AA,TP,3.3X9MM	
RG08	2001-000025	R-CARBON	750HM,5%,1/4W,AA,TP,2.4X6.4MM	
RG09	2001-000290	R-CARBON	10KOHM,5%,1/8W,AA,TP,1.8X3.2MM	
RR01	2001-000969	R-CARBON	750HM,5%,1/8W,AA,TP,1.8X3.2MM	
RR02	2001-000666	R-CARBON	330HM,5%,1/8W,AA,TP,1.8X3.2MM	
RR04	2001-000003	R-CARBON	330ohm,5%,1/8W,AA,TP,1.8x3.2mm	
RR05	2001-000645	R-CARBON	330KOHM,5%,1/8W,AA,TP,1.8X3.2MM	
RR06	2001-000449	R-CARBON	2.2KOHM,5%,1/8W,AA,TP,1.8X3.2MM	
RR07	2001-000705	R-CARBON	390HM,5%,1/2W,AA,TP,3.3X9MM	
RR08	2001-000025	R-CARBON	750HM,5%,1/4W,AA,TP,2.4X6.4MM	
RR09	2001-000290	R-CARBON	10KOHM,5%,1/8W,AA,TP,1.8X3.2MM	
SK101	1405-001064	SURGE ABSORBER	400V,20%,-,AXIAL	
SK102	4715-001055	SURGE ABSORBER	1kV,+50-10%,-,RADIAL	
SK501	4715-001055	SURGE ABSORBER	1kV,+50-10%,-,RADIAL	
SKB01	4715-000102	SURGE ABSORBER	200V,20%,1000A,-,RADIAL	SNA
SKG01	4715-000102	SURGE ABSORBER	200V,20%,1000A,-,RADIAL	SNA
SKR01	4715-000102	SURGE ABSORBER	200V,20%,1000A,-,RADIAL	SNA
TP501	6042-000002	EYELET	ID1.5,OD2,L3,1,SN,BSS3-E/EH	SNA
X201	2801-000005	CRYSTAL-UNIT	8MHz,50ppm,28-AAM,S,35ohm,TP	
ZD101	0403-000509	DIODE-ZENER	MTZJ5.6B,5.6V,5.45-5.73V,500mW	
ZD102	0403-000007	DIODE-ZENER	UZ6.2BSB,5.99-6.24V,500mW,DO-34,TP	
ZD103	0403-000007	DIODE-ZENER	UZ6.2BSB,5.99-6.24V,500mW,DO-34,TP	
ZD104	0403-000007	DIODE-ZENER	UZ6.2BSB,5.99-6.24V,500mW,DO-34,TP	
ZD201	0403-000355	DIODE-ZENER	UZ5.1BSB,5.1V,4.97-5.18V,500mW	
ZD202	0403-000355	DIODE-ZENER	UZ5.1BSB,5.1V,4.97-5.18V,500mW	
ZD203	0403-000355	DIODE-ZENER	UZ5.1BSB,5.1V,4.97-5.18V,500mW	
ZD204	0403-000355	DIODE-ZENER	UZ5.1BSB,5.1V,4.97-5.18V,500mW	
ZD205	0403-000361	DIODE-ZENER	UZ6.2BSB,6.2V,5.99-6.24V,500mW	
ZD210	0403-000361	DIODE-ZENER	UZ6.2BSB,6.2V,5.99-6.24V,500mW	
ZD211	0403-000337	DIODE-ZENER	UZ24BH,24V,24.2-25.7V,500mW,DO	
ZD401	0403-000355	DIODE-ZENER	UZ5.1BSB,5.1V,4.97-5.18V,500mW	
ZD601	0403-000361	DIODE-ZENER	UZ6.2BSB,6.2V,5.99-6.24V,500mW	
ZD602	0403-000509	DIODE-ZENER	MTZJ5.6B,5.6V,5.45-5.73V,500mW	
ZD603	0403-000361	DIODE-ZENER	UZ6.2BSB,6.2V,5.99-6.24V,500mW	
ZD604	0403-000361	DIODE-ZENER	UZ6.2BSB,6.2V,5.99-6.24V,500mW	

7 Electrical Parts List

Loc. No.	Code No.	Description	Specification	Remarks
HS301	BH99-00002A	ASSY,HEAT/SINK	H/S V.IC,SCREW+NUT,KA2142,-,-,OIL SILICON,-,-	SNA
CIS	1204-001508	IC-VERTICAL DEF.	KA2142,SIP,10P,-,PLASTIC,35V,15W,-,20TO+70C,ST,VERTICAL DEFLECTION	
CIS	6006-001008	SCREW-ASS'Y MACH	WSP,BH,+ ,M3,L10,ZPC(YEL),SWRCH	SNA
CIS	6021-000118	NUT-HEXAGON	1C,M3,ZPC(YEL),SM20C	SNA
CIS	BH62-00003A	HEAT/SINK-V.IC	- ,T1,- ,A1050S,DA/DB	SNA
HS601	BH99-00003A	ASSY,HEAT/SINK	H/S POWER,SPRING,DP104,-,-,RUBBER,-,-	SNA
CIS	BH13-00004A	IC-HYBRID	- ,DP104C,TO-220-5L,5P,POWER SWITCH,-,-	
CIS	BH61-00004A	SPRING-TR	CDA,CDB,SUS304,TO.5,-,-,-,-	SNA
CIS	BH62-00004A	HEAT/SINK-POWER	- ,T1,- ,A1050S,DA/DB	SNA
CIS	BH62-20001B	RUBBER	CSQ4357,W25*L20*TO.45,-,-,-,-	SNA
HS103	BH99-00004H	ASSY HEAT/SINK	HS VIDEO,SCREW+NUT,LM2467TA,-,-,OIL SILICON	SNA
CIS	6006-001008	SCREW-ASS'Y MACH	WSP,BH,+ ,M3,L10,ZPC(YEL),SWRCH	SNA
CIS	6021-000118	NUT-HEXAGON	1C,M3,ZPC(YEL),SM20C	SNA
CIS	BH13-00020A	IC HYBRID	LM2467T,PN15H/17L,9P,-,20to+115C,TO-220-9L,10mA,85V,ST	
CIS	BH62-00006A	HEAT SINK-VIDEO	- ,A1050S T2.0,-,DB	SNA
HS402	BH99-00005A	ASSY,HEAT/SINK	H/S,SCREW+NUT,IRF630,-,-,OIL SILICON,-,-	SNA
CIS	BH61-00004A	SPRING-TR	CDA,CDB,SUS304,TO.5,-,-,-,-	SNA
CIS	BH62-00008A	HEAT SINK-TR	- ,SPC-1 L20*H45*T1,-,CDB	SNA
HS401	BH99-00006A	ASSY,HEAT/SINK	H/S,SCREW+NUT,IRF630,-,-,OIL SILICON,-,-	SNA
HS403	BH99-00006A	ASSY,HEAT/SINK	H/S,SCREW+NUT,IRF630,-,-,OIL SILICON,-,-	SNA
CIS	6006-001008	SCREW-ASS'Y MACH	WSP,BH,+ ,M3,L10,ZPC(YEL),SWRCH	SNA
CIS	6021-000118	NUT-HEXAGON	1C,M3,ZPC(YEL),SM20C	SNA
CIS	BH62-30024A	HEAT/SINK-TR	SPC,T1,SN,CFX1577L	SNA
HS501	BH99-00024F	ASSY HEAT/SINK	HS FBT,SPRING,KSC5802,DTV56F,KTD2058,OIL SILICON	SNA
CIS	0402-001413	DIODE-RECTIFIER	DTV56F,1500V,10A,TO-220,ST	
CIS	0502-000465	TR-POWER	KTD2058,NPN,25000mW,TO-220IS,ST,100-200	
CIS	0502-001129	TR-POWER	KSC5802,NPN,70000mW,TO-3PF,ST,20-40	
CIS	BH61-00004A	SPRING-TR	CDA,CDB,SUS304,TO.5,-,-,-,-	SNA
CIS	BH61-70003A	SPRING	CVT4857,STS304-W1/2H,TO.5,W3.8	SNA
CIS	BH62-00015A	HEAT SINK-FBT	A1050S,T1.0,T1.0,-,-	SNA

7-3 Others

Loc. No.	Code No.	Description & Specification	Remarks
CRT ASS'Y PBA UNIT (17LT)	BH03-00016A	M410AR361X114(A/S2),69,17,0.28,-,29.1,FST,H/C,NH,-,MULTI,TILT,4	
(17LO)	BH94-00207A	PN17LT-07C1/4243,-,-,-	SNA
B/D ASS'Y CODE (17LT)	BH94-00226A	PN17LO-07C1/9590,-,-,-	SNA
(17LO)	BH98-00191A	PN17LT-07C1/4243,-,-,-	SNA
S/CABLE	BH98-00206A	PN17LO-07C1/9590,-,-,-	SNA
DEGAUSSING	BH39-00282A	PN17LO,15P/06P,07P,20276,1500MM,UL20276,IVORY,D-SUB/MALE,-,-,-	
MAGNET	BH27-00047A	320*250*1100mm,9.6mH,-,100Ts,±10%	SNA
	3302-000006	AF,14G,1620-1980G,0.58-0.9MGOe	SNA



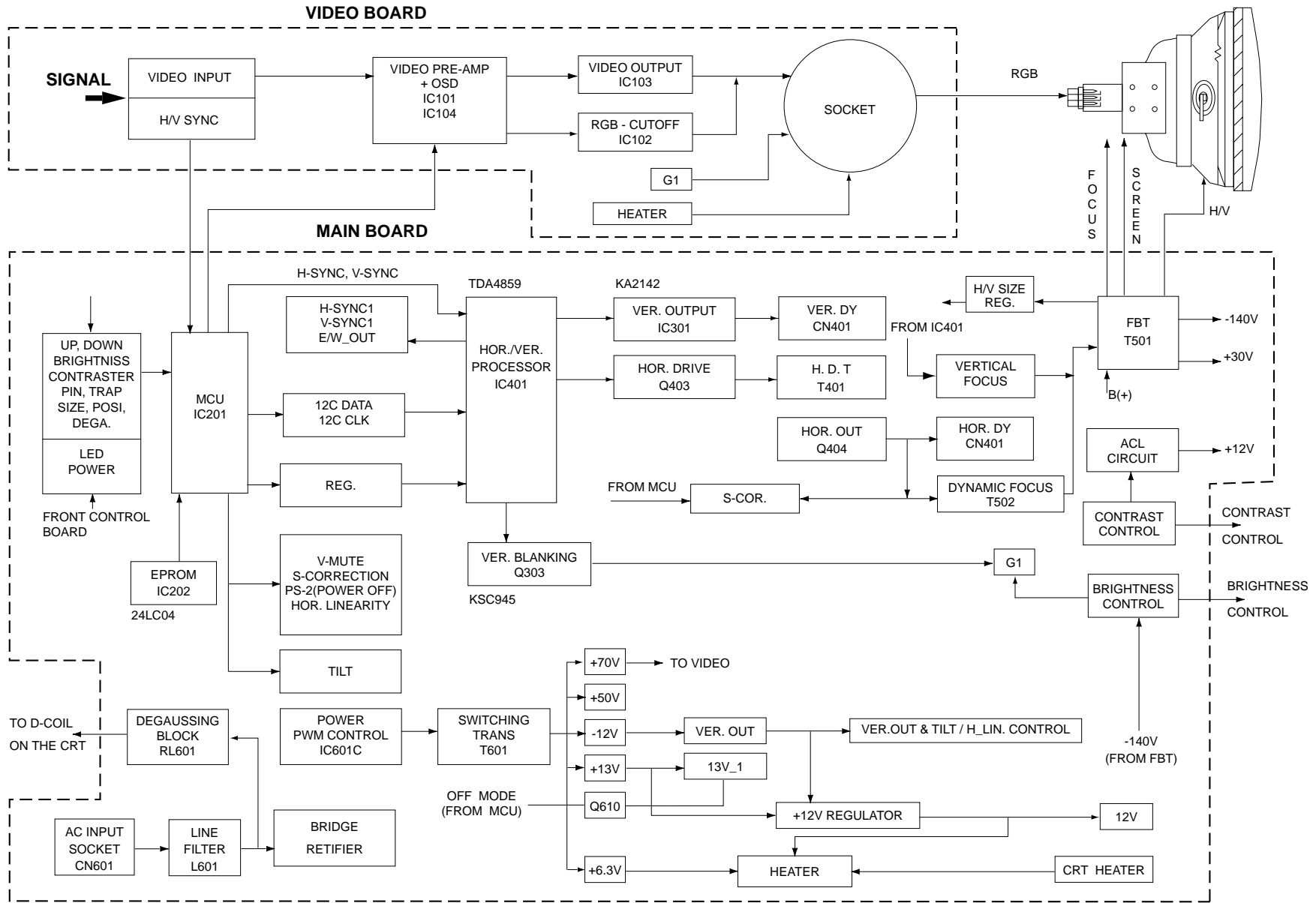

## Memo

# 9 Wiring Diagram

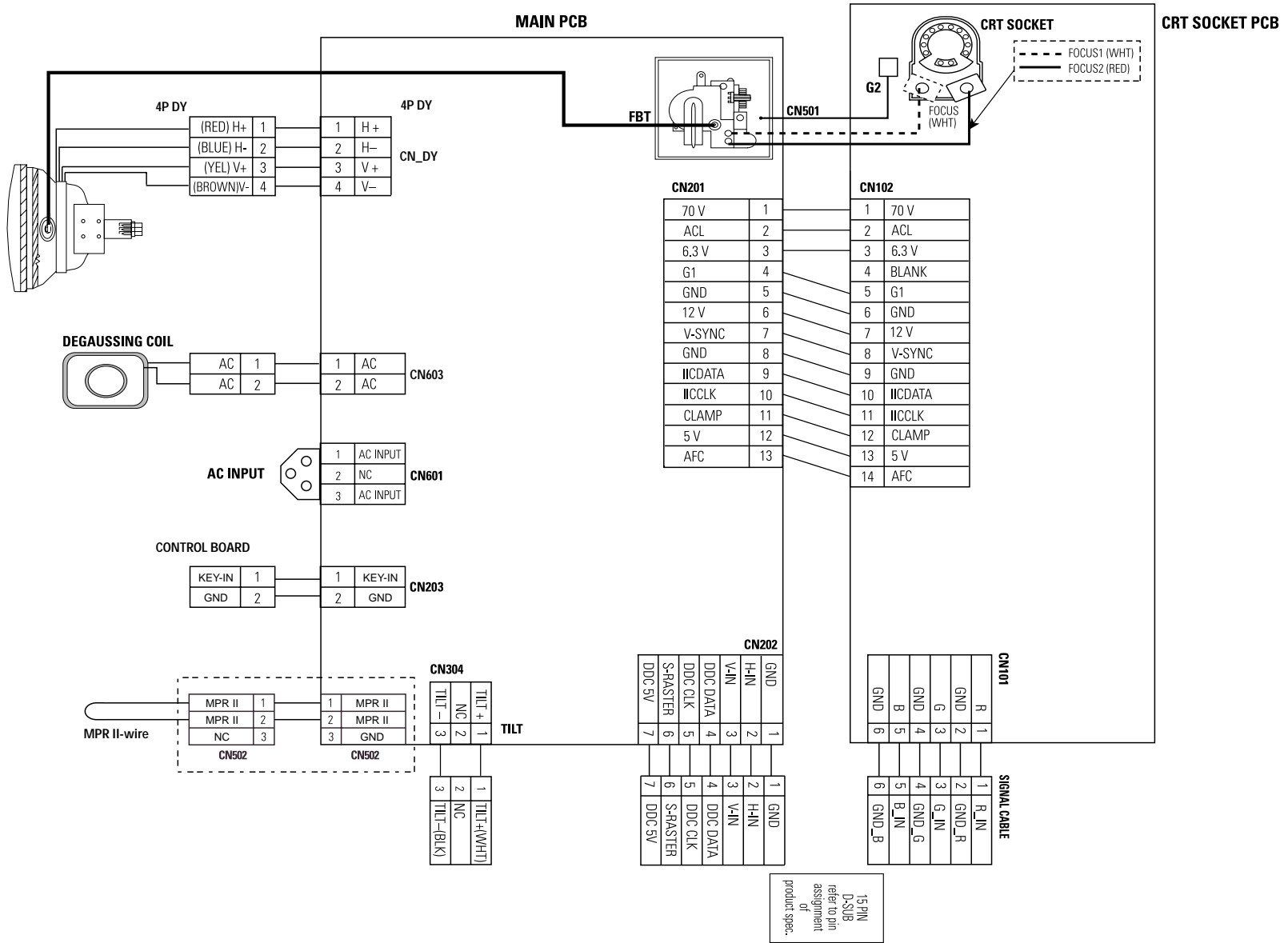

## Memo

# 10 Schematic Diagrams

## 10-1 Main Part Schematic Diagram

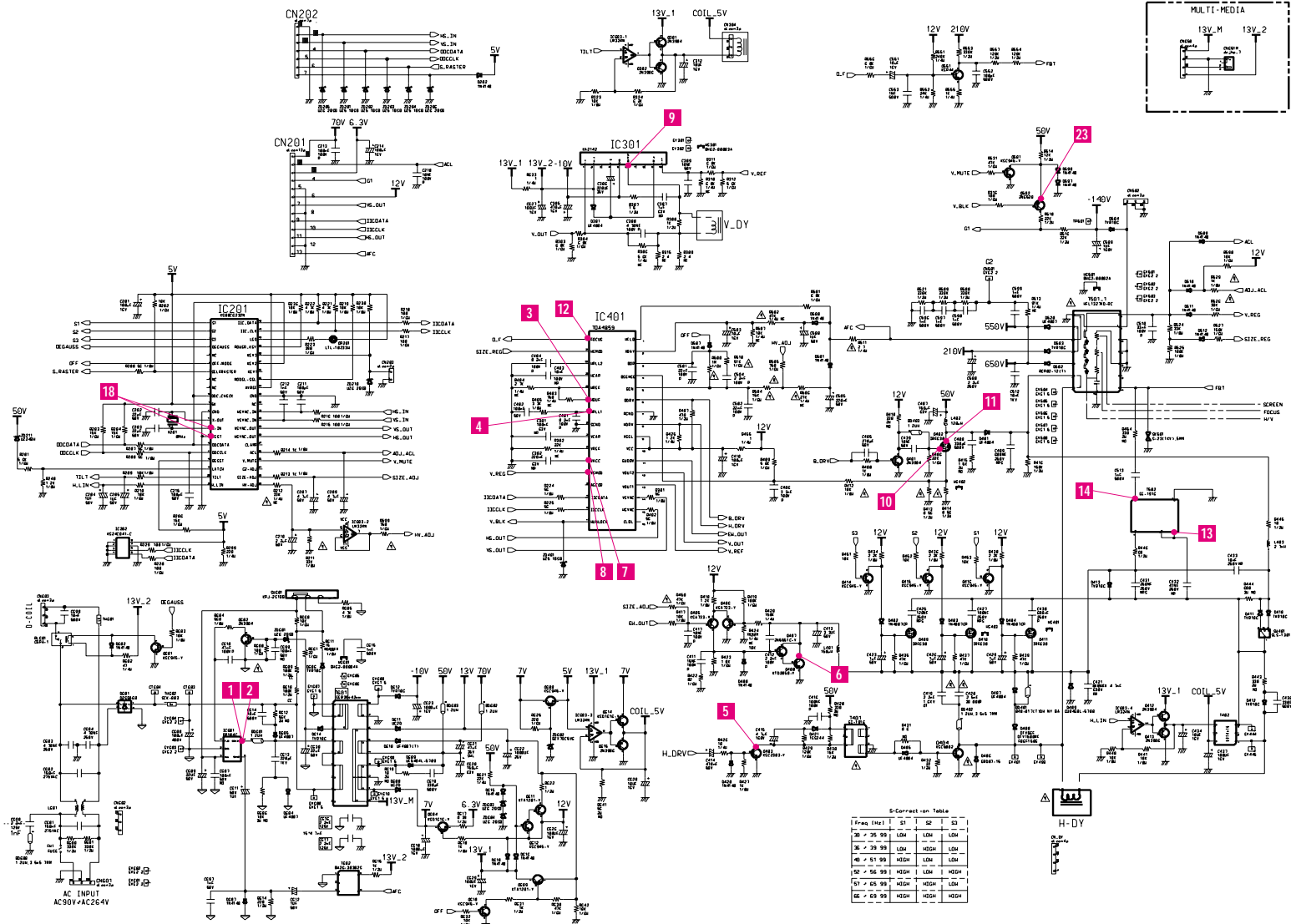

10 Schematic Diagrams

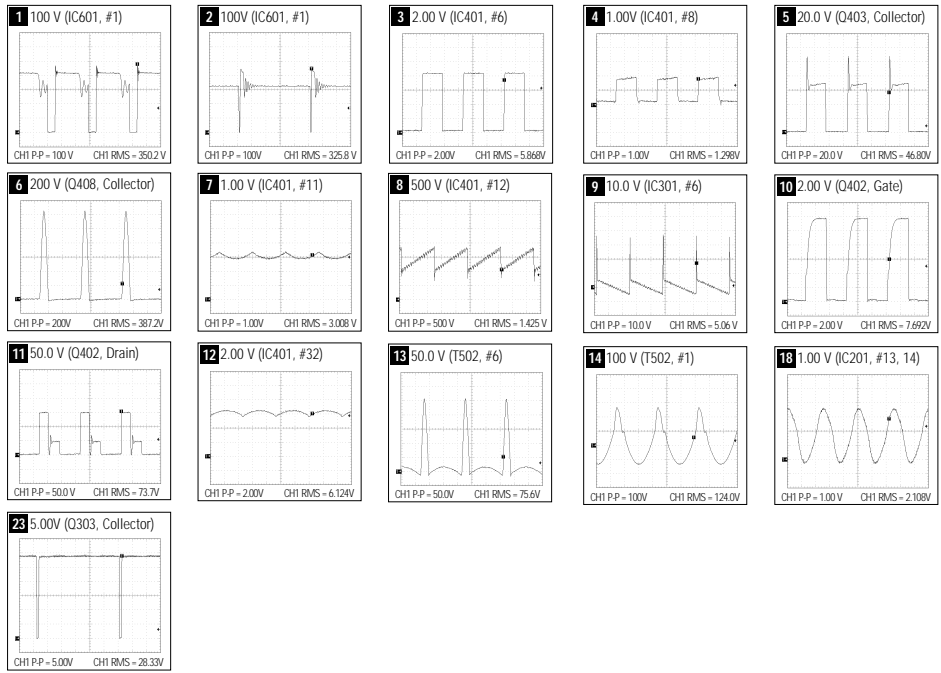

10-2 Video Part Schematic Diagram

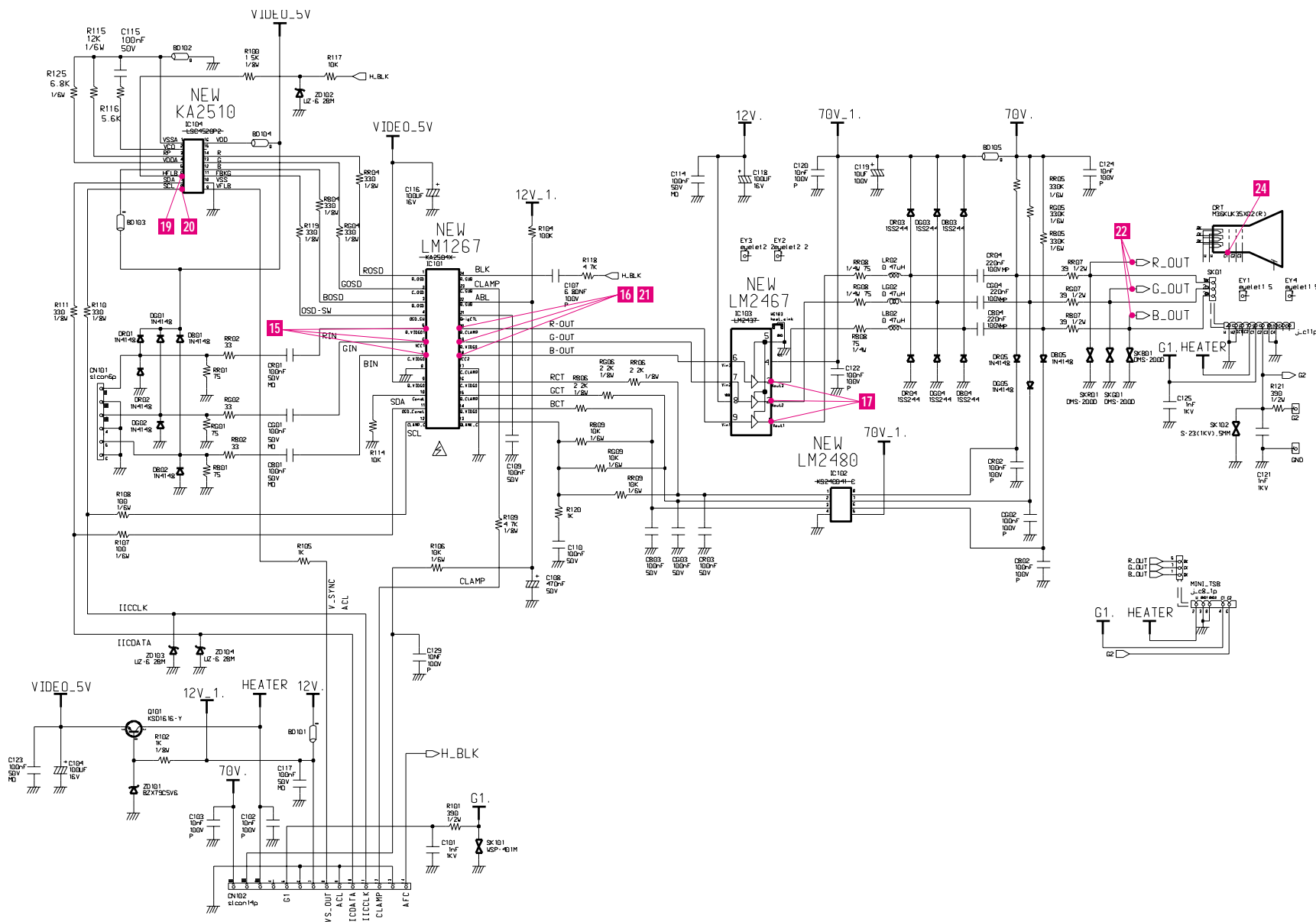

10 Schematic Diagrams

