

## High-Speed, Microcontroller-Adaptable, Pulse Width Modulator

### Features

- High-Speed PWM Operation (12 ns Current Sense to Output Delay)
- Operating Temperature Range: -40°C to +125°C
- Precise Peak Current Limit ( $\pm 5\%$ )
- CMOS Output Driver (Drives MOSFET Driver or Low-Side N-channel MOSFET Directly)
- External Oscillator Input (from PICmicro<sup>®</sup> Microcontroller)
- External Voltage Reference Input (for adjustable voltage or current output application)
- Peak Current Mode Operation to 1 MHz
- Low Operating Current: 2.8 mA, typical
- Fast Output Rise and Fall Times (5.9 ns and 6.2 ns)
- Undervoltage Lockout
- Output Short Circuit Protection
- Overtemperature Protection

### Applications

- Intelligent Power Systems
- Smart Battery Charger Applications
- Multiple Output/Multiple Phase Converters
- Output Voltage Calibration
- AC Power Factor Correction
- VID Capability (Programmed and calibrated by PICmicro Microcontroller)
- Buck/Boost/Buck-Boost/SEPIC/Flyback/Isolated Converters
- Parallel Power Supplies

### Description

The MCP1630 is a high-speed Pulse Width Modulator (PWM) used to develop intelligent power systems. When used with a microcontroller, the MCP1630 will control the power system duty cycle to provide output voltage or current regulation. The microcontroller can be used to adjust output voltage or current, switching frequency, maximum duty cycle and other features making the power system more intelligent and adaptable.

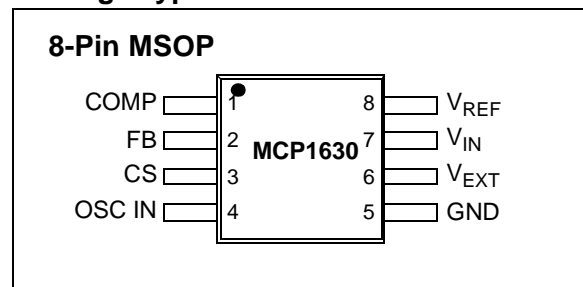
Typical applications include smart battery chargers, intelligent power systems, brick DC/DC converters, AC power-factor correction, multiple output power supplies, multi-phase power supplies and more.

The MCP1630 inputs were developed to be easily attached to the I/O of a microcontroller. The microcontroller supplies the oscillator and reference to the MCP1630 to provide the most flexible and adaptable power system. The power system switching frequency and maximum duty cycle are set using the I/O of the microcontroller. The reference input can be external, a D/A converter output or as simple as an I/O output from the microcontroller. This enables the power system to adapt to many external signals and variables in order to optimize performance and facilitate calibration.

When operating in current mode, a precise limit is set on the peak current. With the fast comparator speed (typically 12 ns), the MCP1630 is capable of providing a tight limit on the maximum switch current over a wide input voltage range when compared to other high-speed PWM controllers.

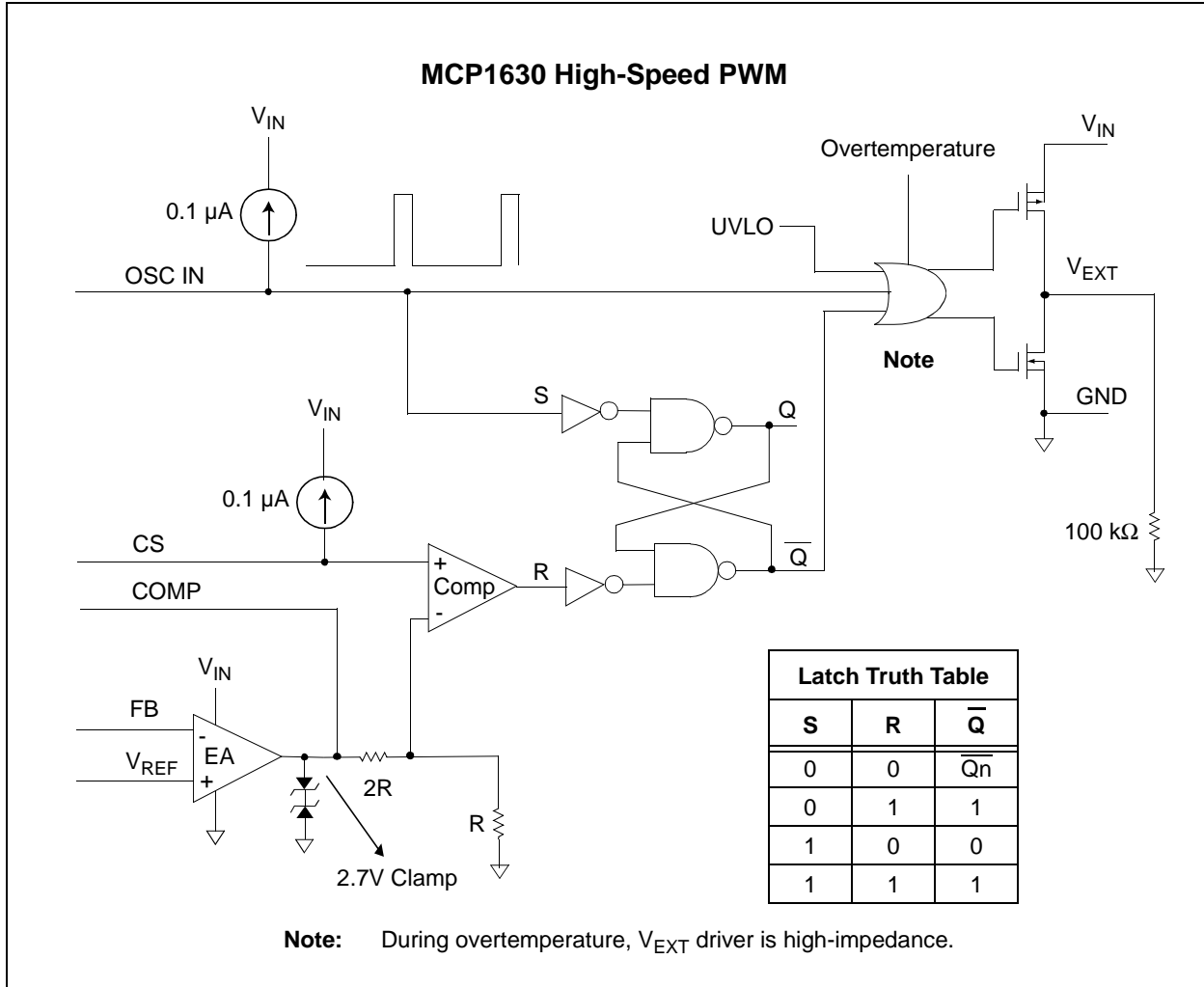
Additional protection features include: undervoltage lockout, overtemperature and overcurrent.

### Package Type

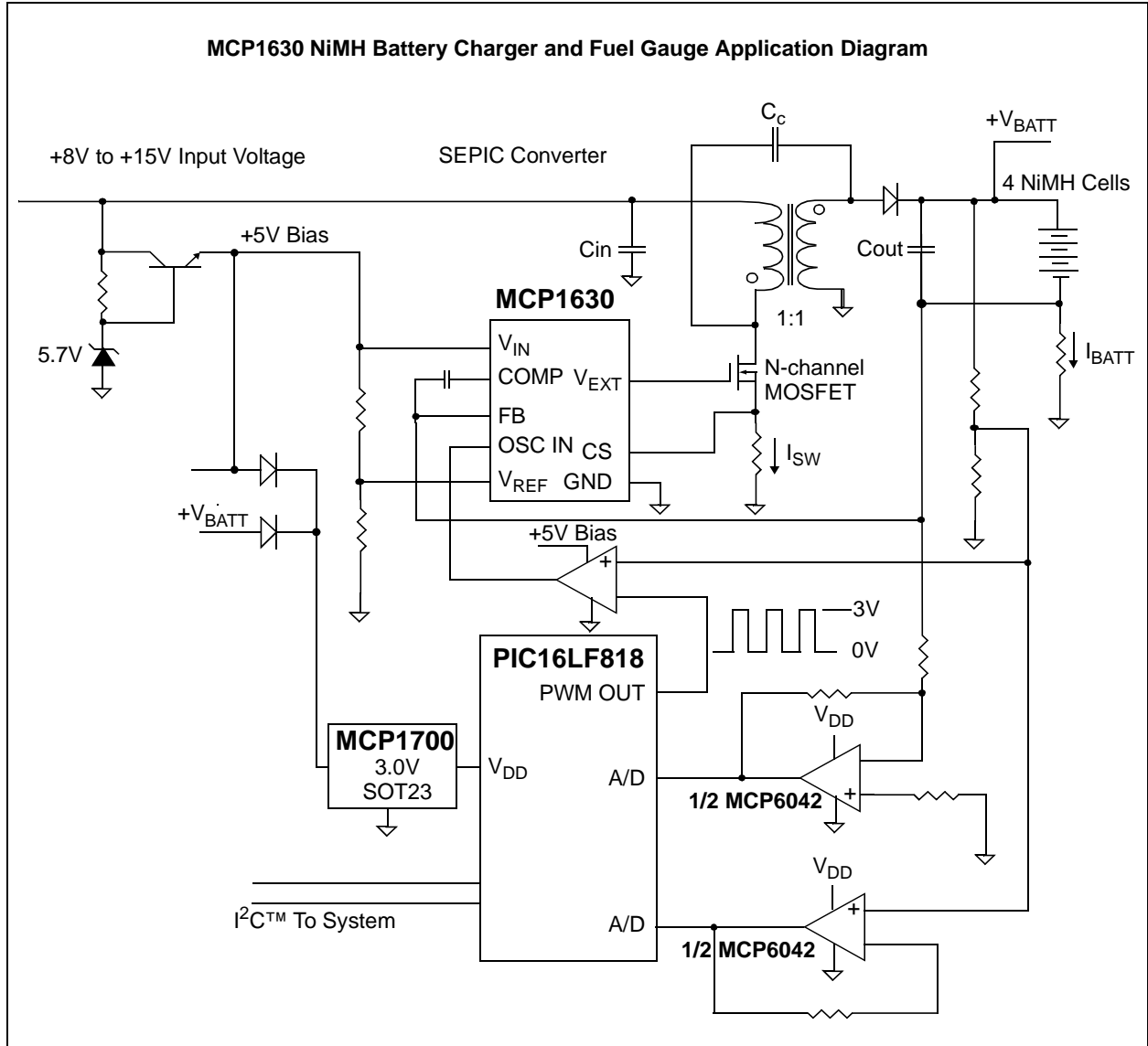


# MCP1630

## Functional Block Diagram



## Typical Application Circuit



# MCP1630

## 1.0 ELECTRICAL CHARACTERISTICS

### Absolute Maximum Ratings †

$V_{DD}$ .....	6.0V
Maximum Voltage on Any Pin .. ( $V_{GND} - 0.3$ )V to ( $V_{IN} + 0.3$ )V	
$V_{EXT}$ Short Circuit Current .....	Internally Limited
Storage temperature .....	-65°C to +150°C
Maximum Junction Temperature, $T_J$ .....	+150°C
Continuous Operating Temperature Range ..	-40°C to +125°C
ESD protection on all pins, Human Body Model.....	3 kV

† **Notice:** Stresses above those listed under “Maximum Ratings” may cause permanent damage to the device. This is a stress rating only and functional operation of the device at those or any other conditions above those indicated in the operational listings of this specification is not implied. Exposure to maximum rating conditions for extended periods may affect device reliability.

### DC CHARACTERISTICS

<b>Electrical Specifications:</b> Unless otherwise noted, $V_{IN} = 3.0V$ to $5.5V$ , $F_{OSC} = 1$ MHz with 10% Duty Cycle, $C_{IN} = 0.1 \mu F$ , $V_{IN}$ for typical values = $5.0V$ , $T_A = -40^\circ C$ to $+125^\circ C$ .						
Parameters	Sym	Min	Typ	Max	Units	Conditions
<b>Input Voltage</b>						
Input Operating Voltage	$V_{IN}$	3.0	—	5.5	V	
Input Quiescent Current	$I(V_{IN})$	—	2.8	4.5	mA	$I_{EXT} = 0$ mA, $F_{OSC\ IN} = 0$ Hz
<b>Oscillator Input</b>						
External Oscillator Range	$F_{OSC}$	—	—	1	MHz	<b>Note 1</b>
Min. Oscillator High Time	$T_{OH\_MIN.}$	—	10		ns	
Min. Oscillator Low Time	$T_{OL\_MIN.}$	—				
Oscillator Rise Time	$T_{RISE}$	0.01	—	10	$\mu s$	<b>Note 2</b>
Oscillator Fall Time	$T_{FALL}$	0.01	—	10	$\mu s$	<b>Note 2</b>
Oscillator Input Voltage Low	$V_L$	—	—	0.8	V	
Oscillator Input Voltage High	$V_H$	2.0	—	—	V	
Oscillator Input Capacitance	$C_{OSC}$		5		pf	
<b>External Reference Input</b>						
Reference Voltage Input	$V_{REF}$	0	—	$V_{IN}$	V	<b>Note 2, Note 3</b>
<b>Error Amplifier</b>						
Input Offset Voltage	$V_{OS}$	-4	0.1	+4	mV	
Error Amplifier PSRR	PSRR	80	99	—	dB	$V_{IN} = 3.0V$ to $5.0V$ , $V_{CM} = 1.2V$
Common Mode Input Range	$V_{CM}$	GND - 0.3	—	$V_{IN}$	V	<b>Note 2, Note 3</b>
Common Mode Rejection Ratio		—	80	—	dB	$V_{IN} = 5V$ , $V_{CM} = 0V$ to $2.5V$
Open-loop Voltage Gain	$A_{VOL}$	85	95	—	dB	$R_L = 5$ k $\Omega$ to $V_{IN}/2$ , $100$ mV $< V_{EAOUT} < V_{IN} - 100$ mV, $V_{CM} = 1.2V$
Low-level Output	$V_{OL}$	—	25	GND + 50	mV	$R_L = 5$ k $\Omega$ to $V_{IN}/2$
Gain Bandwidth Product	GBWP	—	3.5	—	MHz	$V_{IN} = 5V$
Error Amplifier Sink Current	$I_{SINK}$	5	11	—	mA	$V_{IN} = 5V$ , $V_{REF} = 1.2V$ , $V_{FB} = 1.4V$ , $V_{COMP} = 2.0V$
Error Amplifier Source Current	$I_{SOURCE}$	-2	-9	—	mA	$V_{IN} = 5V$ , $V_{REF} = 1.2V$ , $V_{FB} = 1.0V$ , $V_{COMP} = 2.0V$ , Absolute Value

- Note 1:** Capable of higher frequency operation depending on minimum and maximum duty cycles needed.
- Note 2:** External oscillator input (OSC IN) rise and fall times between 10 ns and 10  $\mu s$  used for characterization testing. Signal levels between 0.8V and 2.0V with rise and fall times measured between 10% and 90% of maximum and minimum values. Not production tested.
- Note 3:** The reference input of the internal amplifier is capable of rail-to-rail operation.

## DC CHARACTERISTICS (CONTINUED)

**Electrical Specifications:** Unless otherwise noted,  $V_{IN} = 3.0V$  to  $5.5V$ ,  $F_{OSC} = 1$  MHz with 10% Duty Cycle,  $C_{IN} = 0.1 \mu F$ ,  $V_{IN}$  for typical values =  $5.0V$ ,  $T_A = -40^\circ C$  to  $+125^\circ C$ .

Parameters	Sym	Min	Typ	Max	Units	Conditions
<b>Current Sense Input</b>						
Maximum Current Sense Signal	$V_{CS\_MAX}$	0.85	0.9	0.95	V	Set by maximum error amplifier clamp voltage, divided by 3.
Delay From CS to $V_{EXT}$	$T_{CS\_VEXT}$	—	12	25	ns	
Minimum Duty Cycle	$DC_{MIN}$	—	—	0	%	$V_{FB} = V_{REF} + 0.1V$ , $V_{CS} = GND$
Current Sense Input Bias Current	$I_{CS\_B}$	—	-0.1	—	$\mu A$	$V_{IN} = 5V$
<b>Internal Driver</b>						
$R_{DSon}$ P-channel	$R_{DSon\_P}$	—	10	30	$\Omega$	
$R_{DSon}$ N-channel	$R_{DSon\_N}$	—	7	30	$\Omega$	
$V_{EXT}$ Rise Time	$T_{RISE}$	—	5.9	18	ns	$C_L = 100$ pF Typical for $V_{IN} = 3V$
$V_{EXT}$ Fall Time	$T_{FALL}$	—	6.2	18	ns	$C_L = 100$ pF Typical for $V_{IN} = 3V$
<b>Protection Features</b>						
Under Voltage Lockout	UVLO	2.7	—	3.0	V	$V_{IN}$ falling, $V_{EXT}$ low state when in UVLO
Under Voltage Lockout Hysteresis	UVLO_HYS	50	75	150	mV	
Thermal Shutdown	$T_{SHD}$	—	150	—	$^\circ C$	
Thermal Shutdown Hysteresis	$T_{SHD\_HYS}$	—	18	—	$^\circ C$	

- Note** 1: Capable of higher frequency operation depending on minimum and maximum duty cycles needed.
- 2: External oscillator input (OSC IN) rise and fall times between 10 ns and 10  $\mu s$  used for characterization testing. Signal levels between 0.8V and 2.0V with rise and fall times measured between 10% and 90% of maximum and minimum values. Not production tested.
- 3: The reference input of the internal amplifier is capable of rail-to-rail operation.

## TEMPERATURE SPECIFICATIONS

**Electrical Specifications:**  $V_{IN} = 3.0V$  to  $5.5V$ ,  $F_{OSC} = 1$  MHz with 10% Duty Cycle,  $C_{IN} = 0.1 \mu F$ .  $T_A = -40^\circ C$  to  $+125^\circ C$ .

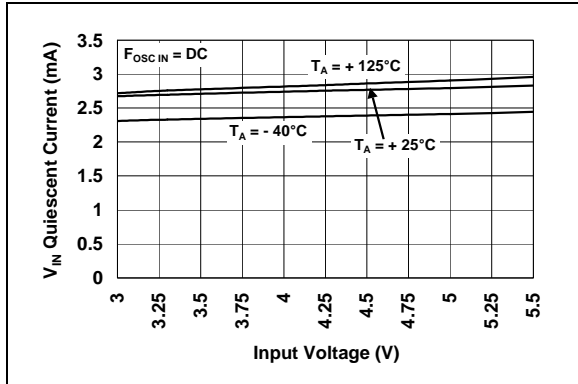
Parameters	Sym	Min	Typ	Max	Units	Conditions
<b>Temperature Ranges</b>						
Operating Junction Temperature Range	$T_A$	-40	—	+125	$^\circ C$	Steady state
Storage Temperature Range	$T_A$	-65	—	+150	$^\circ C$	
Maximum Junction Temperature	$T_J$	—	—	+150	$^\circ C$	Transient
<b>Thermal Package Resistances</b>						
Thermal Resistance, MSOP8	$\theta_{JA}$	—	208	—	$^\circ C/W$	Typical 4-layer board

# MCP1630

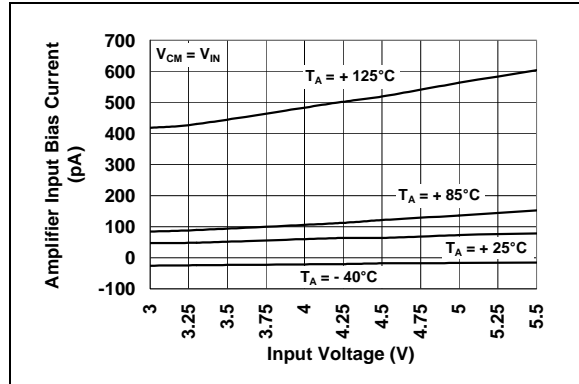
## 2.0 TYPICAL PERFORMANCE CURVES

**Note:** The graphs and tables provided following this note are a statistical summary based on a limited number of samples and are provided for informational purposes only. The performance characteristics listed herein are not tested or guaranteed. In some graphs or tables, the data presented may be outside the specified operating range (e.g., outside specified power supply range) and therefore outside the warranted range.

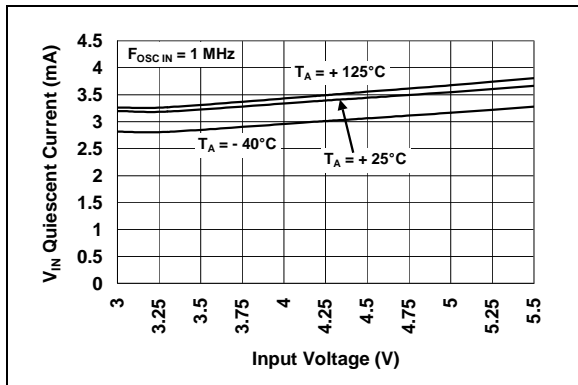
**Note:** Unless otherwise noted,  $V_{IN} = 3.0V$  to  $5.5V$ ,  $F_{OSC} = 1$  MHz with 10% Duty Cycle,  $C_{IN} = 0.1 \mu F$ ,  $V_{IN}$  for typical values =  $5.0V$ ,  $T_A = -40^\circ C$  to  $+125^\circ C$ .



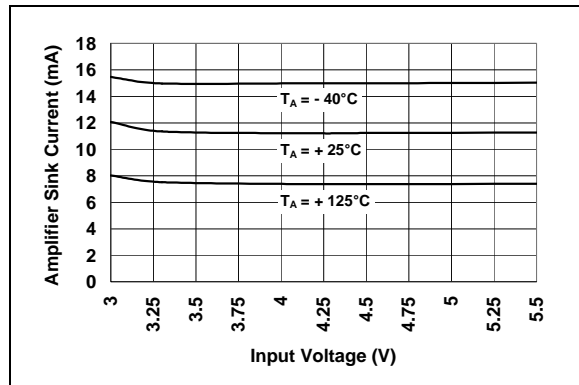
**FIGURE 2-1:** Input Quiescent Current vs. Input Voltage.



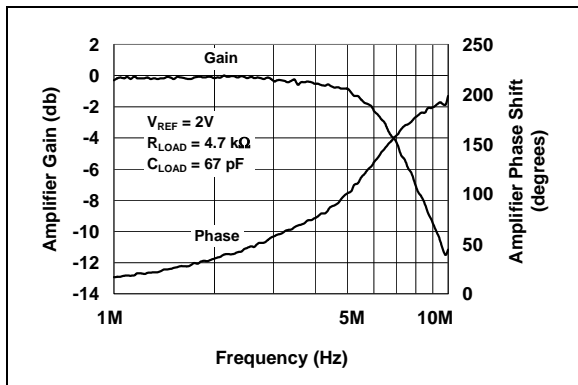
**FIGURE 2-4:** Error Amplifier Input Bias Current vs. Input Voltage.



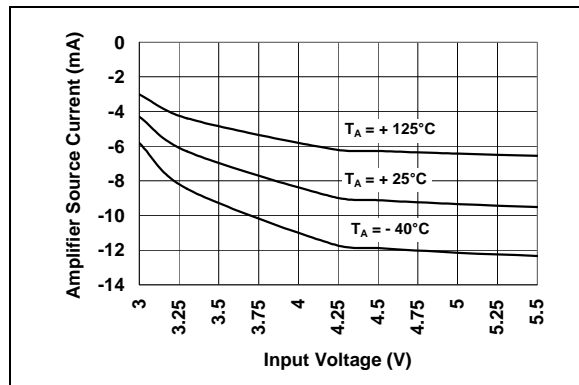
**FIGURE 2-2:** Input Quiescent Current vs. Input Voltage.



**FIGURE 2-5:** Error Amplifier Sink Current vs. Input Voltage.

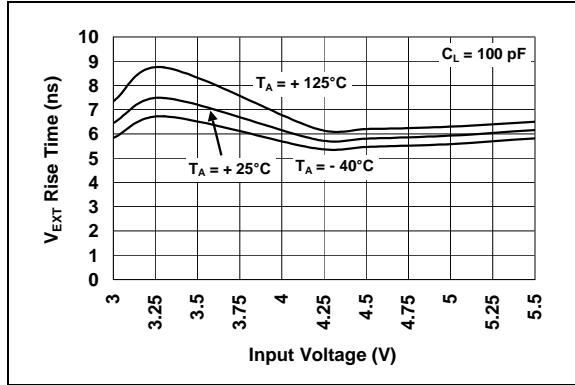


**FIGURE 2-3:** Error Amplifier Frequency Response.

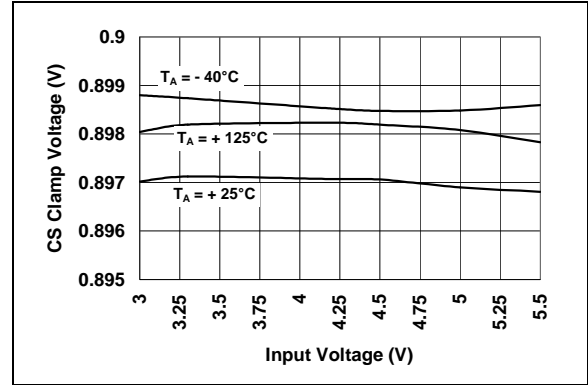


**FIGURE 2-6:** Error Amplifier Source Current vs. Input Voltage.

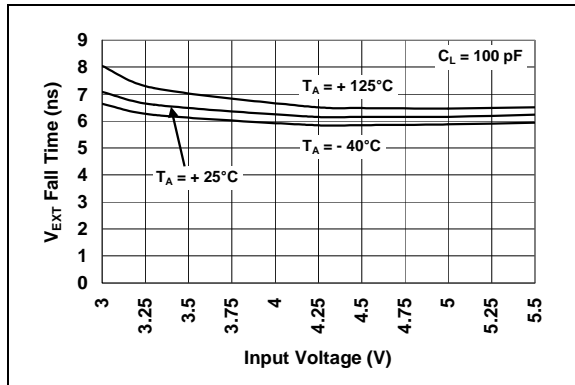
**Note:** Unless otherwise noted,  $V_{IN} = 3.0V$  to  $5.5V$ ,  $F_{OSC} = 1\text{ MHz}$  with 10% Duty Cycle,  $C_{IN} = 0.1\ \mu F$ ,  $V_{IN}$  for typical values =  $5.0V$ ,  $T_A = -40^\circ C$  to  $+125^\circ C$ .



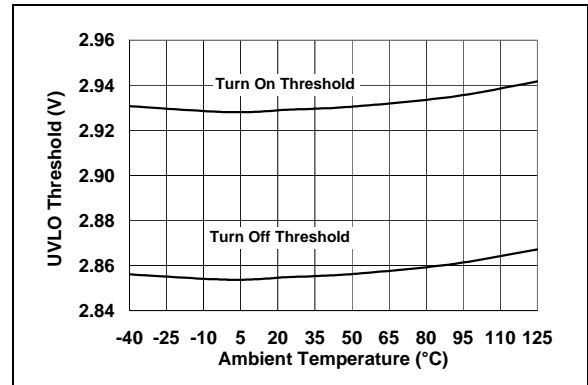
**FIGURE 2-7:**  $V_{EXT}$  Rise Time vs. Input Voltage.



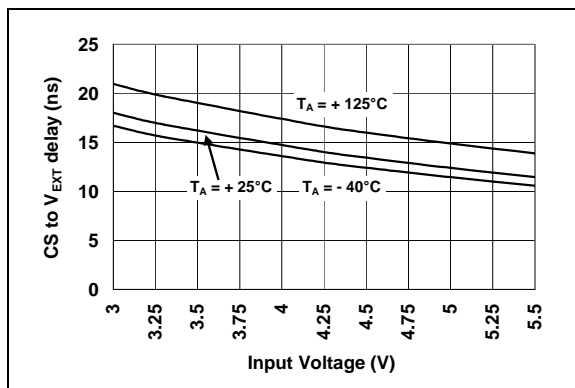
**FIGURE 2-10:** Current Sense Clamp Voltage vs. Input Voltage.



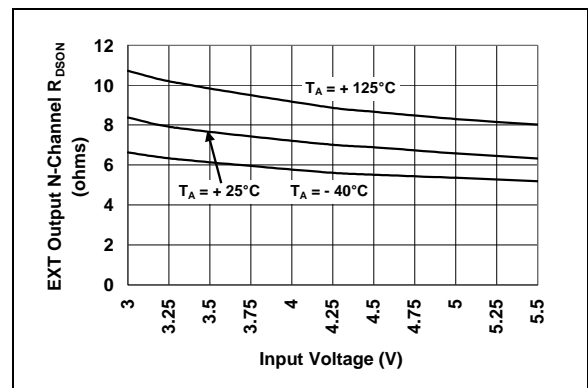
**FIGURE 2-8:**  $V_{EXT}$  Fall Time vs. Input Voltage.



**FIGURE 2-11:** Undervoltage Lockout vs. Temperature.



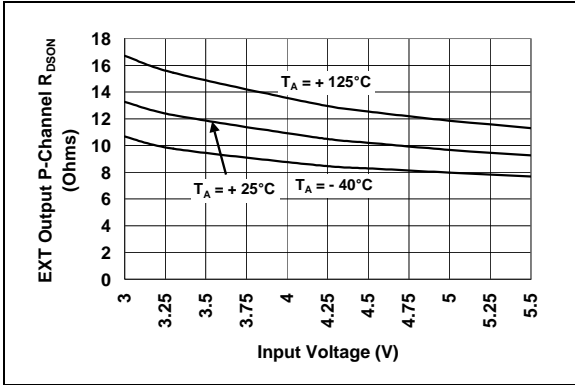
**FIGURE 2-9:** Current Sense to  $V_{EXT}$  Delay vs. Input Voltage.



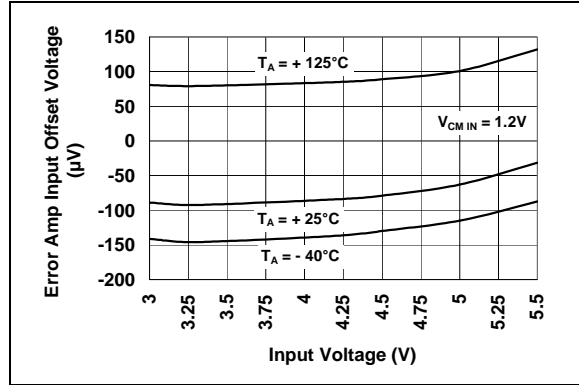
**FIGURE 2-12:** EXT Output N-channel  $R_{DS(on)}$  vs. Input Voltage.

# MCP1630

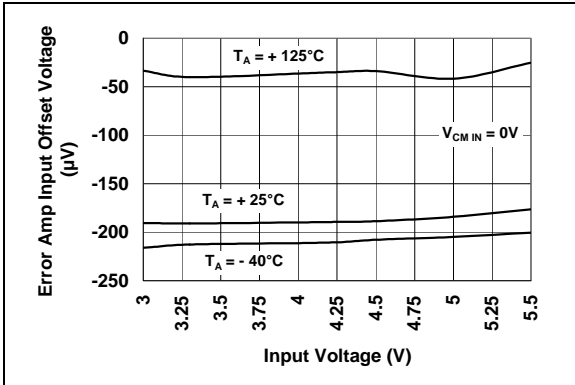
**Note:** Unless otherwise noted,  $V_{IN} = 3.0V$  to  $5.5V$ ,  $F_{OSC} = 1$  MHz with 10% Duty Cycle,  $C_{IN} = 0.1$   $\mu F$ ,  $V_{IN}$  for typical values =  $5.0V$ ,  $T_A = -40^\circ C$  to  $+125^\circ C$ .



**FIGURE 2-13:** EXT Output P-channel  $R_{DSON}$  vs. Input Voltage.



**FIGURE 2-15:** Error Amplifier Input Offset Voltage vs. Input Voltage.



**FIGURE 2-14:** Error Amplifier Input Offset Voltage vs. Input Voltage.



## 3.0 MCP1630 PIN DESCRIPTIONS

The descriptions of the pins are listed in Table 3-1.

**TABLE 3-1: PIN FUNCTION TABLE**

Pin No.	Name	Function
1	COMP	Error Amplifier Output Pin
2	FB	Error Amplifier Inverting Input
3	CS	Current Sense Input pin
4	OSC IN	Oscillator Input pin
5	GND	Circuit Ground Pin
6	V <sub>EXT</sub>	External driver output pin
7	V <sub>IN</sub>	Input bias pin
8	V <sub>REF</sub>	Reference Voltage Input Pin

### 3.1 COMP Pin

COMP is an internal error amplifier output pin. External compensation is connected from the FB pin to the COMP pin for control-loop stabilization. An internal voltage clamp is used to limit the maximum COMP pin voltage to 2.7V typical. This clamp is used to set the maximum peak current in the power system switch by setting a maximum limit on the CS input for peak current mode control systems.

### 3.2 FB Pin

FB is an internal error amplifier inverting input pin. The output (voltage or current) is sensed and fed back to the FB pin for regulation. Inverting or negative feedback is used.

### 3.3 CS Input

CS is the current sense input pin used for cycle-by-cycle control for peak current mode converters. A ramp can be placed on this input for voltage or average current mode converters.

### 3.4 OSC Input

OSC is an external oscillator input pin. Typically, a microcontroller I/O pin is used to generate the OSC input. When high, the output driver (V<sub>EXT</sub>) pin is driven low. The high-to-low transition initiates the start of a new cycle. The duty cycle of the OSC input pin determines the maximum duty cycle of the power converter. For example, if the OSC input is low for 75% of the time and high for 25% of the time, the duty cycle range for the power converter is 0% to 75% maximum.

### 3.5 GND

Connect circuit ground to the GND pin. For most applications, this should be connected to the analog or quiet ground plane. Noise on this ground can affect the sensitive cycle-by-cycle comparison between the CS input and the error amplifier output.

### 3.6 V<sub>EXT</sub> Pin

V<sub>EXT</sub> is an external driver output pin. This output pin is used to determine the power system duty cycle. For high-power or high-side drives, this output should be connected to the logic-level input of the MOSFET driver. For low-power, low-side applications, the V<sub>EXT</sub> pin can be used to directly drive the gate of an N-channel MOSFET.

### 3.7 V<sub>IN</sub> Pin

V<sub>IN</sub> is an input voltage pin. Connect the input voltage source to the V<sub>IN</sub> pin. For normal operation, the voltage on the V<sub>IN</sub> pin should be between +3.0V and +5.5V. A 0.1 μF bypass capacitor should be connected between the V<sub>IN</sub> pin and the GND pin.

### 3.8 V<sub>REF</sub> Input

V<sub>REF</sub> is an external reference input pin used to regulate the output of the power system. By changing the V<sub>REF</sub> input, the output (voltage or current) of the power system can be changed. The reference voltage can range from 0V to V<sub>IN</sub> (rail to rail).

# MCP1630

## 4.0 DETAILED DESCRIPTION

### 4.1 Device Overview

The MCP1630 is comprised of a high-speed comparator, high-bandwidth amplifier and logic gates that can be combined with a PICmicro microcontroller to develop an advanced programmable power supply. The oscillator input and reference voltage input are generated by the PICmicro microcontroller so that switching frequency, maximum duty cycle and output voltage are programmable. Refer to Figure 4-1.

### 4.2 PWM

The  $V_{EXT}$  output of the MCP1630 is determined by the output level of the internal high-speed comparator and the level of the external oscillator. When the oscillator level is high, the PWM ( $V_{EXT}$ ) output is forced low. When the external oscillator is low, the PWM output is determined by the output level of the internal high-speed comparator. During UVLO, the  $V_{EXT}$  pin is held in the low state. During overtemperature operation, the  $V_{EXT}$  pin is high-impedance (100 k $\Omega$  to ground).

### 4.3 Normal Cycle by Cycle Control (peak current mode)

The beginning of a cycle is defined when OSC IN transitions from a high state to a low state. For normal operation, the state of the high-speed comparator output (R) is low and the  $\bar{Q}$  output of the latch is low. On the OSC IN high-to-low transition, the S and R inputs to the high-speed latch are both low and the  $\bar{Q}$  output will remain unchanged (low). The output of the OR gate ( $V_{DRIVE}$ ) will transition from a high state to a low state, turning on the internal P-channel drive transistor in the output stage of the PWM. This will change the PWM output ( $V_{EXT}$ ) from a low state to a high state, turning on the power-train external switch and ramping current in the power-train magnetic device.

The sensed current in the magnetic device is fed into the CS input, shown as a ramp and increases linearly. Once the sensed current ramp reaches the same voltage level as 1/3 of the EA output, the comparator output (R) changes state (low to high) and resets the PWM latch. The  $\bar{Q}$  output transitions from a low state to a high state, turning on the N-channel MOSFET in the output stage which turns off the  $V_{EXT}$  drive to the external MOSFET driver terminating the duty cycle. The OSC IN will transition from a low state to a high state while the  $V_{EXT}$  pin remains unchanged. If the CS input ramp had never reached the same level as 1/3 of the error amplifier output, the low-to-high transition on OSC IN would terminate the duty cycle and this would be considered maximum duty cycle. In either case, while OSC IN is high, the  $V_{EXT}$  drive pin is low, turning off the external power-train switch. The next cycle will start on the transition of the OSC IN pin from a high state to a low state.

### 4.4 Error Amp / Comparator Current Limit Function

The internal amplifier is used to create an error output signal that is determined by the external  $V_{REF}$  input and the power supply output fed back into the FB pin. The error amplifier output is rail-to-rail and clamped by a precision 2.7V. The output of the error amplifier is then divided down 3:1 and connected to the inverting input of the high-speed comparator. Since the maximum output of the error amplifier is 2.7V, the maximum input to the inverting pin of the high-speed comparator is 0.9V. This sets the peak current limit for the switching power supply.

As the output load current demand increases, the error amplifier output increases, causing the inverting input pin of the high-speed comparator to increase. Eventually, the output of the error amplifier will hit the 2.7V clamp, limiting the input of the high-speed comparator to 0.9V, maximum. Even if the FB input continues to decrease (calling for more current), the inverting input is limited to 0.9V. By limiting the inverting input to 0.9V, the current-sense input (CS) is limited to 0.9V, thus limiting the output current of the power supply.

### 4.5 0% Duty Cycle Operation

The duty cycle of the  $V_{EXT}$  output is capable of reaching 0% when the FB pin is held higher than the  $V_{REF}$  pin (inverting error amplifier). This is accomplished by the rail-to-rail output capability of the error amplifier and the offset voltage of the high-speed comparator. The minimum error amplifier output voltage, divided by three, is less than the offset voltage of the high-speed comparator. In the case where the output voltage of the converter is above the desired regulation point, the FB input will be above the  $V_{REF}$  input and the error amplifier will be pulled to the bottom rail (GND). This low voltage is divided down 3:1 by the 2R and 1R resistor and connected to the input of the high-speed comparator. This voltage will be low enough so that there is no triggering of the comparator, allowing narrow pulse widths at  $V_{EXT}$ .

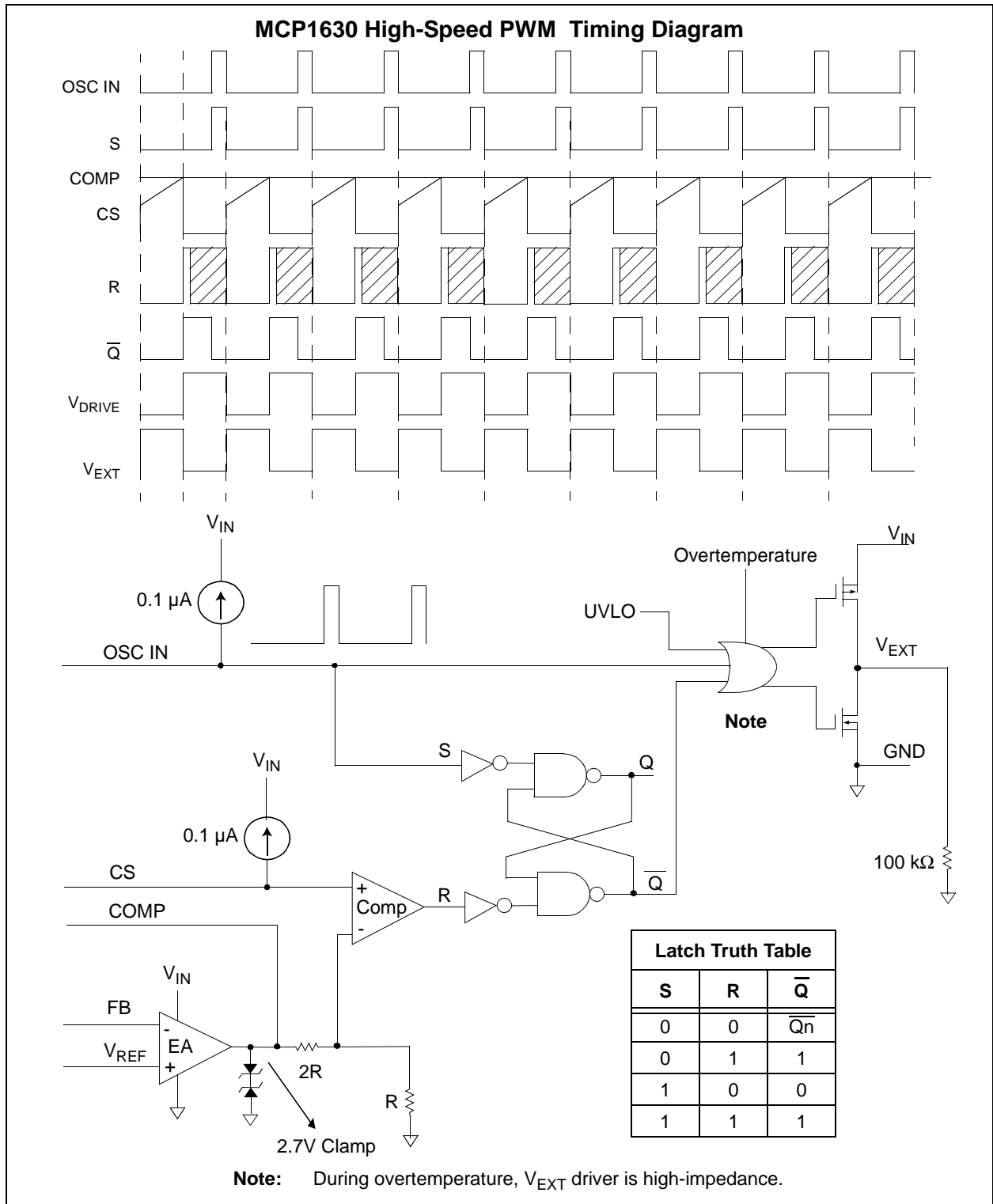
### 4.6 Undervoltage Lockout

When the input voltage ( $V_{IN}$ ) is < the UVLO threshold, the  $V_{EXT}$  is held in the low-impedance state. This will ensure that, if the voltage is not adequate to operate the MCP1630, the main power supply switch will be held in the off state. When the UVLO threshold is exceeded, there is some hysteresis in the input voltage prior to the UVLO off threshold being reached. The typical hysteresis is 75 mV. Typically, the MCP1630 will not start operating until the input voltage at  $V_{IN}$  is between 3.0V and 3.1V.

## 4.7 Overtemperature Protection

To protect the  $V_{EXT}$  output if shorted to  $V_{IN}$  or GND, the MCP1630  $V_{EXT}$  output will be high-impedance if the junction temperature is above the thermal shutdown threshold. There is an internal 100 k $\Omega$  pull-down resis-

tor connected from  $V_{EXT}$  to ground to provide some pull-down during overtemperature conditions. The protection is set to 150°C typical with a hysteresis of 18°C.



**FIGURE 4-1:** Cycle-by-Cycle Timing Diagram

# MCP1630

---

## 5.0 APPLICATION CIRCUITS/ ISSUES

### 5.1 Typical Applications

The MCP1630 high-speed PWM can be used for any circuit topology and power-train application when combined with a microcontroller. Intelligent, cost-effective power systems can be developed for applications that require multiple outputs, multiple phases, adjustable outputs, temperature monitoring and calibration.

### 5.2 NiMH Battery Charger Application

A typical NiMH battery charger application is shown in the “**Typical Application Circuit**” on page 3 of this data sheet. In that example, a Single-ended Primary Inductive Converter (SEPIC) is used to provide a constant charge current to the series-connected batteries. The MCP1630 is used to regulate the charge current by monitoring the current through the battery sense resistor and providing the proper pulse width.

The PIC16F818 monitors the battery voltage to provide a termination to the charge current. Additional features (trickle charge, fast charge, overvoltage protection, etc.) can be added to the system using the programmability of the microcontroller and the flexibility of the MCP1630.

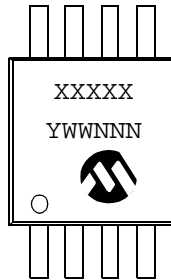
### 5.3 Multiple Output Converters

By using additional MCP1630 devices, multiple output converters can be developed using a single microcontroller. If a two-output converter is desired, the microcontroller can provide two PWM outputs that are phased 180° apart. This will reduce the input ripple current to the source and eliminate beat frequencies.

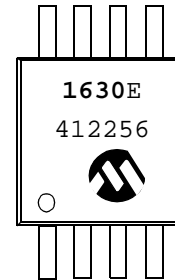
## 6.0 PACKAGING INFORMATION

### 6.1 Package Marking Information

8-Lead MSOP



Example:



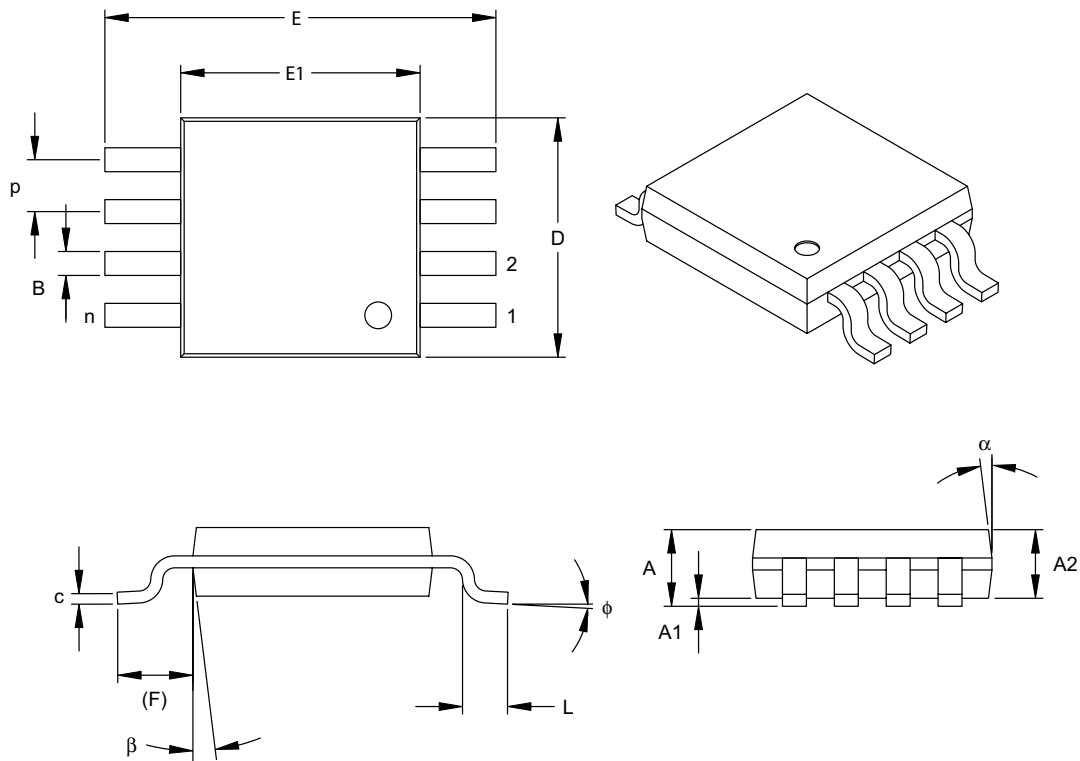
<b>Legend:</b>	XX...X	Customer specific information*
	YY	Year code (last 2 digits of calendar year)
	WW	Week code (week of January 1 is week '01')
	NNN	Alphanumeric traceability code

<b>Note:</b>	In the event the full Microchip part number cannot be marked on one line, it will be carried over to the next line thus limiting the number of available characters for customer specific information.
--------------	--

\* Standard marking consists of Microchip part number, year code, week code, and traceability code.

# MCP1630

## 8-Lead Plastic Micro Small Outline Package (MS) (MSOP)



Dimension Limits	Units	INCHES			MILLIMETERS*		
		MIN	NOM	MAX	MIN	NOM	MAX
Number of Pins	n	8			8		
Pitch	p	.026 BSC			0.65 BSC		
Overall Height	A	-	-	.043	-	-	1.10
Molded Package Thickness	A2	.030	.033	.037	0.75	0.85	0.95
Standoff	A1	.000	-	.006	0.00	-	0.15
Overall Width	E	.193 TYP.			4.90 BSC		
Molded Package Width	E1	.118 BSC			3.00 BSC		
Overall Length	D	.118 BSC			3.00 BSC		
Foot Length	L	.016	.024	.031	0.40	0.60	0.80
Footprint (Reference)	F	.037 REF			0.95 REF		
Foot Angle	$\phi$	0°	-	8°	0°	-	8°
Lead Thickness	c	.003	.006	.009	0.08	-	0.23
Lead Width	B	.009	.012	.016	0.22	-	0.40
Mold Draft Angle Top	$\alpha$	5°	-	15°	5°	-	15°
Mold Draft Angle Bottom	$\beta$	5°	-	15°	5°	-	15°

\*Controlling Parameter

Notes:

Dimensions D and E1 do not include mold flash or protrusions. Mold flash or protrusions shall not exceed .010" (0.254mm) per side.

JEDEC Equivalent: MO-187

Drawing No. C04-111

## PRODUCT IDENTIFICATION SYSTEM

To order or obtain information, e.g., on pricing or delivery, refer to the factory or the listed sales office.

<u>PART NO.</u>	X	/XX
Device	Temperature Range	Package
Device:	MCP1630: High-Speed PWM MCP1630T: High-Speed PWM (Tape and Reel)	
Temperature Range:	E = -40°C to +125°C	
Package:	MS = Plastic MSOP, 8-lead	

**Examples:**

- a) MCP1630-E/MS: Extended Temperature, 8LD MSOP package.
- b) MCP1630T-E/MS: Tape and Reel Extended Temperature, 8LD MSOP package.

## Sales and Support

### **Data Sheets**

Products supported by a preliminary Data Sheet may have an errata sheet describing minor operational differences and recommended workarounds. To determine if an errata sheet exists for a particular device, please contact one of the following:

1. Your local Microchip sales office
2. The Microchip Corporate Literature Center U.S. FAX: (480) 792-7277
3. The Microchip Worldwide Site ([www.microchip.com](http://www.microchip.com))

Please specify which device, revision of silicon and Data Sheet (include Literature #) you are using.

### **Customer Notification System**

Register on our web site ([www.microchip.com/cn](http://www.microchip.com/cn)) to receive the most current information on our products.

# MCP1630

---

NOTES:



---

---

**Note the following details of the code protection feature on Microchip devices:**

- Microchip products meet the specification contained in their particular Microchip Data Sheet.
- Microchip believes that its family of products is one of the most secure families of its kind on the market today, when used in the intended manner and under normal conditions.
- There are dishonest and possibly illegal methods used to breach the code protection feature. All of these methods, to our knowledge, require using the Microchip products in a manner outside the operating specifications contained in Microchip's Data Sheets. Most likely, the person doing so is engaged in theft of intellectual property.
- Microchip is willing to work with the customer who is concerned about the integrity of their code.
- Neither Microchip nor any other semiconductor manufacturer can guarantee the security of their code. Code protection does not mean that we are guaranteeing the product as "unbreakable."

Code protection is constantly evolving. We at Microchip are committed to continuously improving the code protection features of our products. Attempts to break Microchip's code protection feature may be a violation of the Digital Millennium Copyright Act. If such acts allow unauthorized access to your software or other copyrighted work, you may have a right to sue for relief under that Act.

---

Information contained in this publication regarding device applications and the like is intended through suggestion only and may be superseded by updates. It is your responsibility to ensure that your application meets with your specifications. No representation or warranty is given and no liability is assumed by Microchip Technology Incorporated with respect to the accuracy or use of such information, or infringement of patents or other intellectual property rights arising from such use or otherwise. Use of Microchip's products as critical components in life support systems is not authorized except with express written approval by Microchip. No licenses are conveyed, implicitly or otherwise, under any intellectual property rights.

**Trademarks**

The Microchip name and logo, the Microchip logo, Accuron, dsPIC, KEELOQ, microID, MPLAB, PIC, PICmicro, PICSTART, PRO MATE, PowerSmart, rfPIC, and SmartShunt are registered trademarks of Microchip Technology Incorporated in the U.S.A. and other countries.

AmpLab, FilterLab, MXDEV, MXLAB, PICMASTER, SEEVAL, SmartSensor and The Embedded Control Solutions Company are registered trademarks of Microchip Technology Incorporated in the U.S.A.

Analog-for-the-Digital Age, Application Maestro, dsPICDEM, dsPICDEM.net, dsPICworks, ECAN, ECONOMONITOR, FanSense, FlexROM, fuzzyLAB, In-Circuit Serial Programming, ICSP, ICEPIC, Migratable Memory, MPASM, MPLIB, MPLINK, MPSIM, PICkit, PICDEM, PICDEM.net, PICLAB, PICtail, PowerCal, PowerInfo, PowerMate, PowerTool, rLAB, rfPICDEM, Select Mode, Smart Serial, SmartTel and Total Endurance are trademarks of Microchip Technology Incorporated in the U.S.A. and other countries.

SQTP is a service mark of Microchip Technology Incorporated in the U.S.A.

All other trademarks mentioned herein are property of their respective companies.

© 2004, Microchip Technology Incorporated, Printed in the U.S.A., All Rights Reserved.

 Printed on recycled paper.

**QUALITY MANAGEMENT SYSTEM**  
**CERTIFIED BY DNV**  
**== ISO/TS 16949:2002 ==**

*Microchip received ISO/TS-16949:2002 quality system certification for its worldwide headquarters, design and wafer fabrication facilities in Chandler and Tempe, Arizona and Mountain View, California in October 2003. The Company's quality system processes and procedures are for its PICmicro® 8-bit MCUs, KEELOQ® code hopping devices, Serial EEPROMs, microperipherals, nonvolatile memory and analog products. In addition, Microchip's quality system for the design and manufacture of development systems is ISO 9001:2000 certified.*



## WORLDWIDE SALES AND SERVICE

### AMERICAS

#### Corporate Office

2355 West Chandler Blvd.  
Chandler, AZ 85224-6199  
Tel: 480-792-7200  
Fax: 480-792-7277  
Technical Support: 480-792-7627  
Web Address: www.microchip.com

#### Atlanta

3780 Mansell Road, Suite 130  
Alpharetta, GA 30022  
Tel: 770-640-0034  
Fax: 770-640-0307

#### Boston

2 Lan Drive, Suite 120  
Westford, MA 01886  
Tel: 978-692-3848  
Fax: 978-692-3821

#### Chicago

333 Pierce Road, Suite 180  
Itasca, IL 60143  
Tel: 630-285-0071  
Fax: 630-285-0075

#### Dallas

4570 Westgrove Drive, Suite 160  
Addison, TX 75001  
Tel: 972-818-7423  
Fax: 972-818-2924

#### Detroit

Tri-Atria Office Building  
32255 Northwestern Highway, Suite 190  
Farmington Hills, MI 48334  
Tel: 248-538-2250  
Fax: 248-538-2260

#### Kokomo

2767 S. Albright Road  
Kokomo, IN 46902  
Tel: 765-864-8360  
Fax: 765-864-8387

#### Los Angeles

18201 Von Karman, Suite 1090  
Irvine, CA 92612  
Tel: 949-263-1888  
Fax: 949-263-1338

#### San Jose

1300 Terra Bella Avenue  
Mountain View, CA 94043  
Tel: 650-215-1444  
Fax: 650-961-0286

#### Toronto

6285 Northam Drive, Suite 108  
Mississauga, Ontario L4V 1X5, Canada  
Tel: 905-673-0699  
Fax: 905-673-6509

### ASIA/PACIFIC

#### Australia

Suite 22, 41 Rawson Street  
Epping 2121, NSW  
Australia  
Tel: 61-2-9868-6733  
Fax: 61-2-9868-6755

#### China - Beijing

Unit 706B  
Wan Tai Bei Hai Bldg.  
No. 6 Chaoyangmen Bei Str.  
Beijing, 100027, China  
Tel: 86-10-85282100  
Fax: 86-10-85282104

#### China - Chengdu

Rm. 2401-2402, 24th Floor,  
Ming Xing Financial Tower  
No. 88 TIDU Street  
Chengdu 610016, China  
Tel: 86-28-86766200  
Fax: 86-28-86766599

#### China - Fuzhou

Unit 28F, World Trade Plaza  
No. 71 Wusi Road  
Fuzhou 350001, China  
Tel: 86-591-7503506  
Fax: 86-591-7503521

#### China - Hong Kong SAR

Unit 901-6, Tower 2, Metroplaza  
223 Hing Fong Road  
Kwai Fong, N.T., Hong Kong  
Tel: 852-2401-1200  
Fax: 852-2401-3431

#### China - Shanghai

Room 701, Bldg. B  
Far East International Plaza  
No. 317 Xian Xia Road  
Shanghai, 200051  
Tel: 86-21-6275-5700  
Fax: 86-21-6275-5060

#### China - Shenzhen

Rm. 1812, 18/F, Building A, United Plaza  
No. 5022 Binhe Road, Futian District  
Shenzhen 518033, China  
Tel: 86-755-82901380  
Fax: 86-755-8295-1393

#### China - Shunde

Room 401, Hongjian Building, No. 2  
Fengxiangnan Road, Ronggui Town, Shunde  
District, Foshan City, Guangdong 528303, China  
Tel: 86-757-28395507 Fax: 86-757-28395571

#### China - Qingdao

Rm. B505A, Fullhope Plaza,  
No. 12 Hong Kong Central Rd.  
Qingdao 266071, China  
Tel: 86-532-5027355 Fax: 86-532-5027205

#### India

Divyasree Chambers  
1 Floor, Wing A (A3/A4)  
No. 11, O'Shaughnessy Road  
Bangalore, 560 025, India  
Tel: 91-80-22290061 Fax: 91-80-22290062

#### Japan

Benex S-1 6F  
3-18-20, Shinyokohama  
Kohoku-Ku, Yokohama-shi  
Kanagawa, 222-0033, Japan  
Tel: 81-45-471- 6166 Fax: 81-45-471-6122

#### Korea

168-1, Youngbo Bldg. 3 Floor  
Samsung-Dong, Kangnam-Ku  
Seoul, Korea 135-882  
Tel: 82-2-554-7200 Fax: 82-2-558-5932 or  
82-2-558-5934

#### Singapore

200 Middle Road  
#07-02 Prime Centre  
Singapore, 188980  
Tel: 65-6334-8870 Fax: 65-6334-8850

#### Taiwan

Kaohsiung Branch  
30F - 1 No. 8  
Min Chuan 2nd Road  
Kaohsiung 806, Taiwan  
Tel: 886-7-536-4818  
Fax: 886-7-536-4803

#### Taiwan

Taiwan Branch  
11F-3, No. 207  
Tung Hua North Road  
Taipei, 105, Taiwan  
Tel: 886-2-2717-7175 Fax: 886-2-2545-0139

### EUROPE

#### Austria

Durisolstrasse 2  
A-4600 Wels  
Austria  
Tel: 43-7242-2244-399  
Fax: 43-7242-2244-393

#### Denmark

Regus Business Centre  
Lautrup høj 1-3  
Ballerup DK-2750 Denmark  
Tel: 45-4420-9895 Fax: 45-4420-9910

#### France

Parc d'Activite du Moulin de Massy  
43 Rue du Saule Trapu  
Batiment A - Ier Etage  
91300 Massy, France  
Tel: 33-1-69-53-63-20  
Fax: 33-1-69-30-90-79

#### Germany

Steinheilstrasse 10  
D-85737 Ismaning, Germany  
Tel: 49-89-627-144-0  
Fax: 49-89-627-144-44

#### Italy

Via Quasimodo, 12  
20025 Legnano (MI)  
Milan, Italy  
Tel: 39-0331-742611  
Fax: 39-0331-466781

#### Netherlands

Waegenburghtplein 4  
NL-5152 JR, Drunen, Netherlands  
Tel: 31-416-690399  
Fax: 31-416-690340

#### United Kingdom

505 Eskdale Road  
Widdersh Triangle  
Wokingham  
Berkshire, England RG41 5TU  
Tel: 44-118-921-5869  
Fax: 44-118-921-5820

05/28/04