

Powerex, Inc., Hillis Street, Youngwood, Pennsylvania 15697 (724) 925-7272

POW-R-BLOK™
Dual Diode Isolated Module
1100 Amperes / Up to 2400 Volts

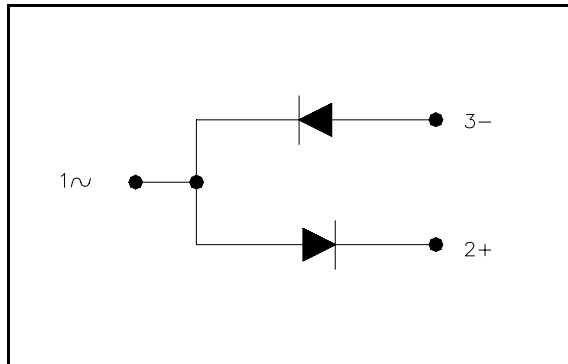

Ordering Information:

Select the complete eight-digit module part number from the table below.

Example: PD412411 is a 2400 Volt, 1100A Average Dual Diode Isolated POW-R-BLOK™ Module

Type	Voltage Volts (x100)	Current Amperes (x100)
PD41	18	11
	20	
	22	
	24	

Description:

Powerex Dual Diode Modules are designed for use in applications requiring rectification and isolated packaging. The modules are isolated for easy mounting with other components on a common heatsink.

Features:

- Electrically Isolated Heatsinking
- Compression Bonded Elements
- Metal Baseplate
- Low Thermal Impedance for Improved Current Capability

Benefits:

- No Additional Insulation Components Required
- Easy Installation
- No Clamping Components Required
- Reduce Engineering Time

Applications:

- Bridge Circuits
- AC & DC Motor Drives
- Battery Supplies
- Power Supplies
- Large IGBT Circuit Front Ends

Powerex, Inc., Hillis Street, Youngwood, Pennsylvania 15697 (724) 925-7272

POW-R-BLOK™
Dual Diode Isolated Module
1100 Amperes / Up to 2400 Volts

Absolute Maximum Ratings

Characteristics	Conditions	Symbol	Units
Repetitive Peak Reverse Blocking Voltage		V _{RRM}	Up to 2400 V
Non-Repetitive Peak Blocking Voltage (t < 5 msec)		V _{RSM}	V _{RRM} + 100V V
RMS Current Per Diode (180° Conduction)	180° Conduction, T _C =80° C	I _{F(RMS)}	1885 A
	180° Conduction, T_C=87° C	I _{F(RMS)}	1725 A
	180° Conduction, T _C =95° C	I _{F(RMS)}	1570 A
	180° Conduction, T _C =98° C	I _{F(RMS)}	1415 A
Average Forward Current Per Diode (180° Conduction)	180° Conduction, T _C =80° C	I _{F(AV)}	1200 A
	180° Conduction, T_C=87° C	I _{F(AV)}	1100 A
	180° Conduction, T _C =95° C	I _{F(AV)}	1000 A
	180° Conduction, T _C =98° C	I _{F(AV)}	900 A
Peak One Cycle Surge Current, Non-Repetitive T _j = 25C, V _r = 0	60 Hz	I _{FSM}	50,890 A
	50 Hz	I _{FSM}	46,400 A
Peak One Cycle Surge Current, Non-Repetitive T _j = 25C, V _r = V _{rrm}	60 Hz	I _{FSM}	33,925 A
	50 Hz	I _{FSM}	30,935 A
Peak One Cycle Surge Current, Non-Repetitive T _j = 125C, V _r = 0	60 Hz	I _{FSM}	44,250 A
	50 Hz	I _{FSM}	40,350 A
Peak One Cycle Surge Current, Non-Repetitive T _j = 125C, V _r = V _{rrm}	60 Hz	I _{FSM}	29,500 A
	50 Hz	I _{FSM}	26,900 A
Peak Three Cycle Surge Current, Non-Repetitive	60 Hz, T _j = 125C, V _r = V _{rrm}	I _{FSM}	23,690 A
Peak Ten Cycle Surge Current, Non-Repetitive	60 Hz, T _j = 125C, V _r = V _{rrm}	I _{FSM}	18,615 A
I ² t for Fusing for One Cycle T _j = 125C, V _r = V _{rrm}	8.3 milliseconds	I ² t	3.63 x 10 ⁶ A ² sec
	10 milliseconds	I ² t	3.62 x 10 ⁶ A ² sec
Operating Temperature		T _J	-40 to +150 °C
Storage Temperature		T _{stg}	-40 to +150 °C
Max. Mounting Torque, M6 Mounting Screw			132 in. – Lb.
			15 Nm
Max. Mounting Torque, M10 Terminal Screw			106 in. – Lb.
			12 Nm
Module Weight, Typical			455 g
			11.75 lb
V Isolation @ 25C		V _{rms}	3000 V

Electrical Characteristics, T_J=25° C unless otherwise specified

Characteristics	Symbol	Test Conditions	Min.	Max.	Units
Repetitive Peak Reverse Leakage Current	I _{RRM}	Up to 2400V, T _J =125° C		100	mA
Peak On-State Voltage	V _{FM}	I _{FM} =3000A, T _J =125° C		1.75	V
Threshold Voltage, Low-level	V _{(TO)1}	T _J = 125° C, I = 15%I _{T(AV)} to π I _{T(AV)}		0.869	V
Slope Resistance, Low-level	r _{T1}			0.237	mΩ
Threshold Voltage, High-level	V _{(TO)2}	T _J = 125° C, I = π I _{T(AV)} to I _{TSM}		1.055	V
Slope Resistance, High-level	r _{T2}			0.175	mΩ
V _{FM} Coefficients, Full Range		T _J = 125° C, I = 50A to 6kA V _{FM} = A+ B Ln I +C I + D Sqrt I	A = B = C = D =	0.93159 -4.51 E-02 9.95 E-05 1.29 E-02	
Typical Reverse Recovery Time	t _{rr}	T _J = 25° C, I _{fm} = 1500A. di _r /dt = 25 A/us, t _p = 190 us		22	us

Thermal Characteristics

Characteristics	Symbol	Max.	Units	
Thermal Resistance, Junction to Case	R _{θJ-C}	Per Module, both conducting Per Junction, both conducting	0.029 0.058	°C/W °C/W
Thermal Impedance Coefficients	Z _{θJ-C}	Z _{θJ-C} = K ₁ (1-exp(-t/τ ₁)) + K ₂ (1-exp(-t/τ ₂)) + K ₃ (1-exp(-t/τ ₃)) + K ₄ (1-exp(-t/τ ₄))	K ₁ = 5.04 E-04 K ₂ = 2.31 E-03 K ₃ = 2.83 E-03 K ₄ =5.24 E-02	τ ₁ = 2.47 E-03 τ ₂ = 4.42 E-02 τ ₃ = 1.370 τ ₄ = 9.668
Thermal Resistance, Case to Sink Lubricated	R _{θC-S}	Per Module	0.009	°C/W

Powerex, Inc., Hillis Street, Youngwood, Pennsylvania 15697 (724) 925-7272

Dual Diode Module 1100 Amperes / Up to 2400 Volts

Typical On-State Forward Voltage Drop
($T_j = 150^\circ\text{C}$)

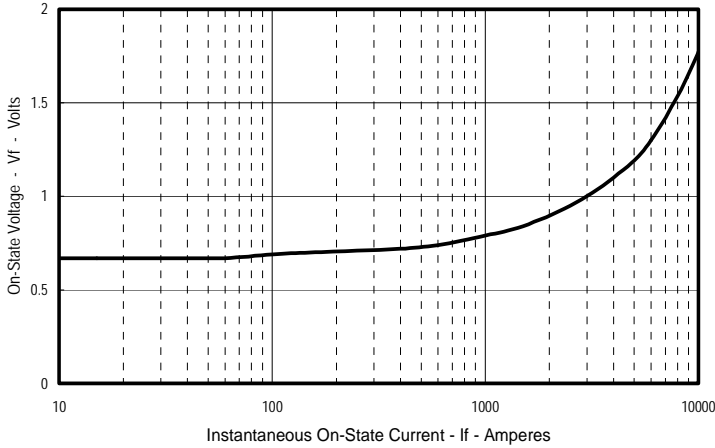

Maximum Transient Thermal Impedance
(Junction To Case)

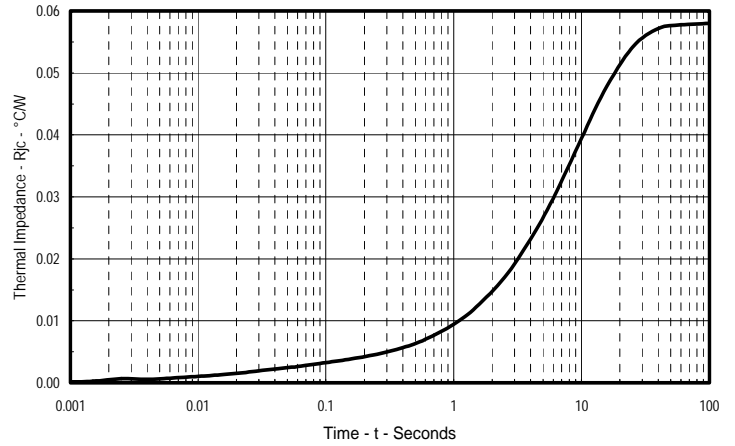

Maximum On-State Power Dissipation
(Sinusoidal Waveform)

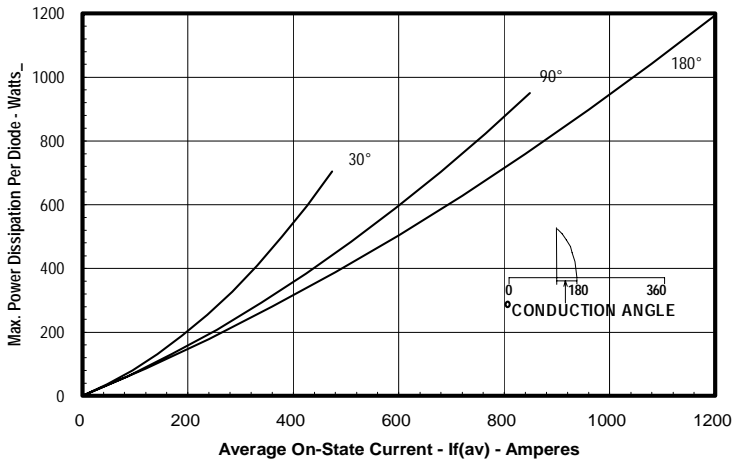

Maximum Allowable Case Temperature
(Sinusoidal Waveform)

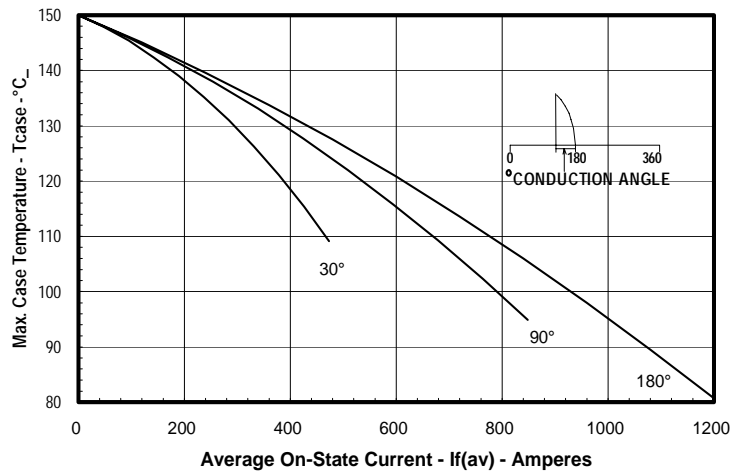

Maximum On-State Power Dissipation
(Rectangular Waveform)

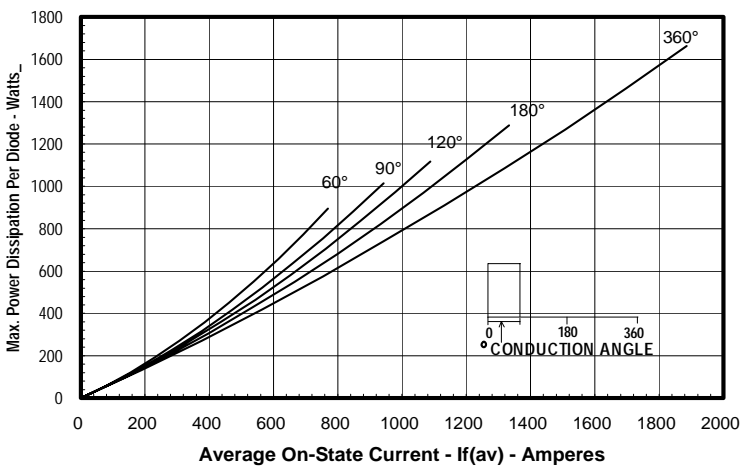

Maximum Allowable Case Temperature
(Rectangular Waveform)

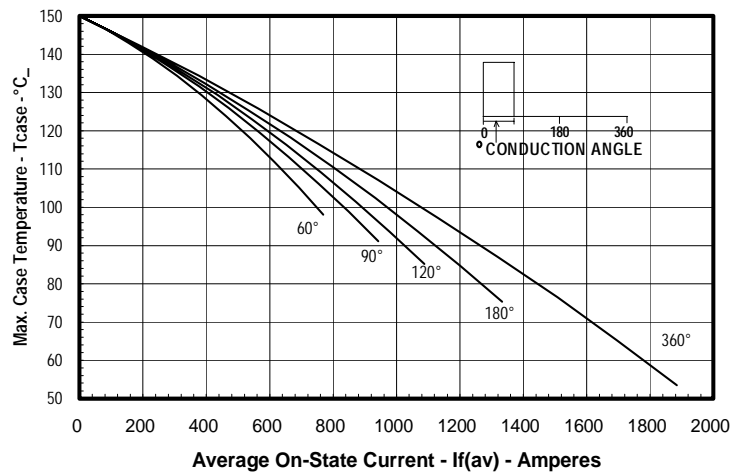

Powerex, Inc., Hillis Street, Youngwood, Pennsylvania 15697 (724) 925-7272

Dual Diode Module
1100 Amperes / Up to 2400 Volts

DIM.	INCHES	MILLIMETERS
A	7.80	198.1
B	4.00	101.6
C	2.68	68.1
D	6.44	163.6
E	3.44	87.4
F	.28	7.1
G	7.31	185.7
H	7.00	177.8
M	.281	7.1
N	.45	11.4
P	.54	13.7
Q	5.93	150.6
R	.19	4.8
T	.48	12.2
U	2.28	58
W	4.93	125.2
X	3.81	96.8
Z	2.00	50.8
AA	1.00	25.4
BB	.50	12.7
CC	1.00	25.4
DD	.406	10.3
EE	2.87	72.9
FF	.66	16.8

