

M52321SP

3-CHANNEL VIDEO PREAMPLIFIER WITH OSD MIXING FUNCTION FOR HIGH-DEFINITION COLOR DISPLAYS

DESCRIPTION

The M52321SP semiconductor integrated circuit is a video amplifier with OSD mixing function. It has three channels of 100-MHz amplifiers.

OSD blanking function, OSD mixing function, wide-band amplifier, main and sub contrast controls, main and sub brightness controls are provided for each channel. This semiconductor is optimal for high-definition displays with an OSD.

FEATURES

- Frequency band : RGB 100MHz (at 3V_{P-P})
OSD 50MHz
- Input : RGB 0.7V_{P-P} (standard)
OSD 4V_{P-P} or more (polarity : positive)
BLK 4V_{P-P} or more (polarity : positive)
- Output : RGB 4.0V_{P-P} (max)
OSD 4.0V_{P-P} (max)
- Both contrast and brightness can be adjusted with a main or sub control. The main control is used to change contrast or brightness for three channels at the same time. The sub control is used to change contrast or brightness for each channel independently. Each control pin can be controlled in a range between 0V and 5V.
- A feedback circuit is built in the IC, enabling stable DC supply at IC output pins.

APPLICATION

CRT displays

PIN CONFIGURATION (TOP VIEW)

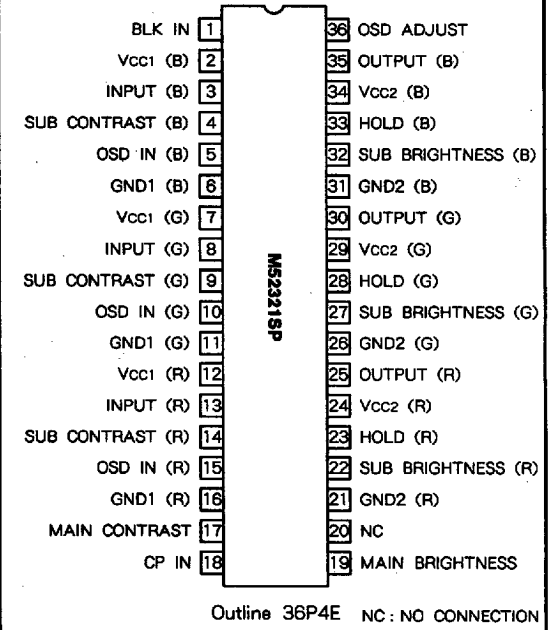

RECOMMENDED OPERATIONAL CONDITION

Supply voltage range..... 11.5~12.5V
Rated voltage range..... 12.0V

BLOCK DIAGRAM

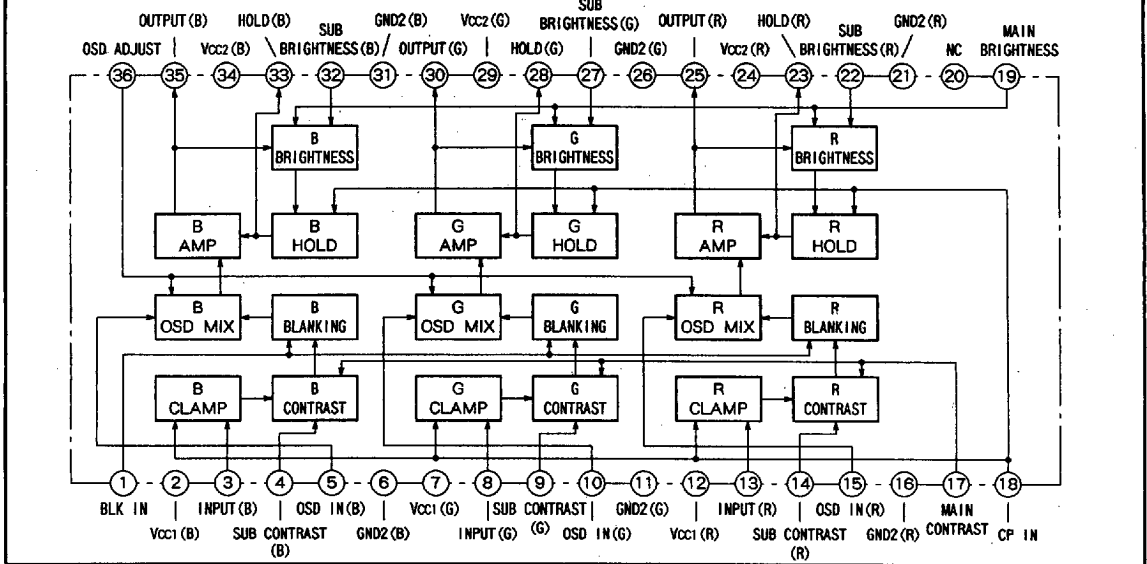

M52321SP

**3-CHANNEL VIDEO PREAMPLIFIER WITH OSD MIXING FUNCTION
FOR HIGH-DEFINITION COLOR DISPLAYS**

ABSOLUTE MAXIMUM RATINGS (Ta = 25 °C)

Symbol	Parameter	Rating	Unit
Vcc	Supply voltage	13.0	V
Pa	Power dissipation	2016	mW
Topr	Operating temperature	- 20 ~ + 85	°C
Tstg	Storage temperature	- 40 ~ + 150	°C
Vopr	Recommended operating voltage	12.0	V
Vopr'	Recommended operating voltage range	11.5 ~ 12.5	V
Sarge	Surge voltage resistance	± 200	V

M52321SP

3-CHANNEL VIDEO PREAMPLIFIER WITH OSD MIXING FUNCTION FOR HIGH-DEFINITION COLOR DISPLAYS

ELECTRICAL CHARACTERISTICS (Ta = 25°C, Vcc = 12V, unless otherwise specified)

Symbol	Parameter	Test point	Input			External power supply (V)					Pulse input			Limits		Unit		
			SW13 R-ch	SW8 G-ch	SW3 B-ch	V4	V17	V19	V32	V36	SW18	SW15,10,15	Min.	Typ.	Max.			
Icc	Circuit current	A	a	a	a	5	5	5	5	5	2	a	b	a	70	100	140	mA
Vomax	Output dynamic range	T.P35 T.P30 T.P25	b	b	b	5	5	Variable	5	5	-	a	a	a	5.8	6.8	9.0	Vp-p
Vimax	Maximum allowable input	T.P35 T.P30 T.P25	b	b	b	5	2.5	Variable	5	5	-	a	a	a	1.7	2.4	2.9	Vp-p
Gv	Maximum gain	T.P35 T.P30 T.P25	b	b	b	5	5	Vt	5	5	-	a	a	a	13	17	20	dB
ΔGv	Relative maximum gain		Calculate using the measured values.															
Vcr1	Contrast control characteristic (typical)	T.P35 T.P30 T.P25	b	b	b	5	2	Vt	5	5	-	a	a	a	5	8	11	dB
ΔVcr1	Relative contrast control characteristic (typical)		Calculate using the measured values.															
Vcr2	Contrast control characteristic (minimum)	T.P35 T.P30 T.P25	b	b	b	5	1	Vt	5	5	-	a	a	a	0.3	0.6	0.9	Vp-p
ΔVcr2	Relative contrast control characteristic (minimum)		Calculate using the measured values.															
Vscr1	Sub contrast control characteristic (typical)	T.P35 T.P30 T.P25	b	b	b	2	5	Vt	5	5	-	a	a	a	6	9	12	dB
ΔVscr1	Relative sub contrast control characteristic (typical)		Calculate using the measured values.															
Vscr2	Sub contrast control characteristic (minimum)	T.P35 T.P30 T.P25	b	b	b	1	5	Vt	5	5	-	a	a	a	0.5	0.9	1.3	Vp-p
ΔVscr2	Relative sub contrast control characteristic (minimum)		Calculate using the measured values.															
Vscr3	Main/Sub contrast control characteristic (typical for both main and sub controls)	T.P35 T.P30 T.P25	b	b	b	3	3	Vt	5	5	-	a	a	a	0.8	1.5	2.2	Vp-p
ΔVscr3	Relative main/sub contrast control characteristics (typical for both main and sub controls)		Calculate using the measured values.															

6249826 0020184 318



3-CHANNEL VIDEO PREAMPLIFIER WITH OSD MIXING FUNCTION FOR HIGH-DEFINITION COLOR DISPLAYS

ELECTRICAL CHARACTERISTICS (cont.) (Ta = 25°C, Vcc = 12V, unless otherwise specified)

Symbol	Parameter	Test point	Input				External power supply (V)				Pulse input			Limits		Unit			
			SW13 R-ch	SW8 G-ch	SW3 B-ch	V4	V17	V19	V32	V36	SW18	SW15	10,15	Min.	Typ.		Max.		
Vb1	Brightness control characteristic (maximum)	T.P35 T.P30 T.P25	a	a	a	5	5	4	5	-	-	b	a	3.0	3.6	4.2	V		
ΔVb1	Relative brightness characteristic (maximum)	Calculate using the measured values.														0	0.3	V	
Vaz	Brightness control characteristic (typical)	T.P35 T.P30 T.P25	a	a	a	5	5	2.5	5	-	-	b	a	1.7	2.3	2.9	V		
ΔVaz	Relative brightness characteristic (typical)	Calculate using the measured values.														-0.3	0	0.3	V
Vbs	Brightness control characteristic (minimum)	T.P35 T.P30 T.P25	a	a	a	5	5	1	5	-	-	b	a	0.5	0.9	1.3	Vcc		
ΔVbs	Relative brightness characteristic (minimum)	Calculate using the measured values.														-0.3	0	0.3	V
Vsb1	Sub brightness control characteristic (maximum)	T.P35 T.P30 T.P25	a	a	a	5	5	2	5	-	-	b	a	1.3	1.8	2.4	Vcc		
Vsb1	Sub brightness control characteristic (minimum)	T.P35 T.P30 T.P25	a	a	a	5	5	2	0	-	-	b	a	-	0	0.5	Vcc		
Fc1	Frequency characteristic 1 (f = 50MHz, maximum)	T.P35 T.P30 T.P25	b	b	b	5	2.5	Vt	-	-	-	a	a	-2.5	-1	3	dB		
ΔFc1	Relative frequency characteristic 1 (f = 50MHz, maximum)	Calculate using the measured values.														-1	0	1	dB
Fc1'	Frequency characteristic 1 (f = 100MHz, maximum)	T.P35 T.P30 T.P25	b	b	b	5	2.5	Vt	-	-	-	a	a	-3	-2	3	dB		
ΔFc1'	Relative frequency characteristic 1 (f = 100MHz, maximum)	Calculate using the measured values.														-1	0	1	dB
Fc2	Frequency characteristic 2 (f = 100MHz, typical)	T.P35 T.P30 T.P25	b	b	b	5	1.5	Vt	-	-	-	a	a	-3	0	3	dB		
ΔFc2	Relative frequency characteristic 2 (f = 100MHz, typical)	Calculate using the measured values.														-1	0	1	dB



6249826 0020185 254

M52321SP

3-CHANNEL VIDEO PREAMPLIFIER WITH OSD MIXING FUNCTION FOR HIGH-DEFINITION COLOR DISPLAYS

ELECTRICAL CHARACTERISTICS (cont.) (Ta = 25°C, Vcc = 12V, unless otherwise specified)

Symbol	Parameter	Test point	Input			External power supply (V)					Pulse input			Limits			Unit
			SW13 Rch	SW8 G-ch	SW3 B-ch	V4	V17	V19	V32	V36	SW18	SW15	SW10,15	Min.	Typ.	Max.	
Fc3	Frequency characteristic 3 (f = 100MHz, minimum)	T.P35 T.P30 T.P25	b SG4	b SG4	b SG4	5	0.5	Vr	-	-	-	a	a	-3	0	3	dB
ΔFc3	Relative frequency characteristic 3 (f = 100MHz, minimum)	Calculate using the measured values.															dB
C.T.1	Crosstalk 1 (f = 50MHz)	T.P35 T.P30 T.P25	b SG3	a	a	5	5	Vr	5	-	-	a	a	-	-30	-20	dB
C.T.1'	Crosstalk 1 (f = 100MHz)	T.P35 T.P30 T.P25	b SG4	a	a	5	5	Vr	5	-	-	a	a	-	-20	-15	dB
C.T.2	Crosstalk 2 (f = 50MHz)	T.P35 T.P30 T.P25	a	b SG3	a	5	5	Vr	5	-	-	a	a	-	-30	-20	dB
C.T.2'	Crosstalk 2 (f = 100MHz)	T.P35 T.P30 T.P25	a	b SG4	a	5	5	Vr	5	-	-	a	a	-	-20	-15	dB
C.T.3	Crosstalk 3 (f = 50MHz)	T.P35 T.P30 T.P25	a	a	b SG3	5	5	Vr	5	-	-	a	a	-	-30	-20	dB
C.T.3'	Crosstalk 3 (f = 100MHz)	T.P35 T.P30 T.P25	a	a	b SG4	5	5	Vr	5	-	-	a	a	-	-20	-15	dB
Tr	Pulse characteristic 1	T.P35 T.P30 T.P25	b SG5	b SG5	b SG5	5	2	5	5	-	-	b SG6	a	-	4	7	ns
Tf	Pulse characteristic 2	T.P35 T.P30 T.P25	b SG5	b SG5	b SG5	5	2	5	5	-	-	b SG6	a	-	4	7	ns
V14th	Clamp pulse threshold voltage	T.P35 T.P30 T.P25	a	a	a	5	5	2	5	-	-	b SG6	a	-0.7	1.5	2.5	Voc
W14	Clamp pulse operating minimum width	T.P35 T.P30 T.P25	a	a	a	5	5	2	5	-	-	b SG6	a	-	0.3	1.0	μs



3-CHANNEL VIDEO PREAMPLIFIER WITH OSD MIXING FUNCTION
FOR HIGH-DEFINITION COLOR DISPLAYS

ELECTRICAL CHARACTERISTICS (cont.) (Ta = 25°C, Vcc = 12V, unless otherwise specified)

Symbol	Parameter	Test point	Input			External power supply (V)							Pulse input			Limits		Unit		
			SW13 Rch	SW8 G-ch	SW3 B-ch	V4	V17	V19	V32	V36	SW18	SW15 10,15	Min.	Typ.	Max.					
Poch	Pedestal voltage temperature characteristic 1	T.P35 T.P30 T.P25	b SG7	b SG7	b SG7	5	5	2	5	-	-	b SG6		-0.3	0	0.3	V _{oc}			
Pocl	Pedestal voltage temperature characteristic 2	T.P35 T.P30 T.P25	b SG7	b SG7	b SG7	5	5	2	5	-	-	b SG6		-0.3	0	0.3	V _{oc}			
OTr	OSD pulse characteristic 1	T.P35 T.P30 T.P25	a -	a -	a -	5	5	2	5	1.7	-	a SG8		-	4	9	ns			
OTf	OSD pulse characteristic 2	T.P35 T.P30 T.P25	a -	a -	a -	5	5	2	5	1.7	-	a SG8		-	4	9	ns			
Oaj1	OSD adjusting control characteristic (maximum)	T.P35 T.P30 T.P25	a -	a -	a -	5	5	2	5	1.7	-	a SG8		3	3.6	4.2	V _{PP}			
ΔOaj1	Relative OSD adjusting control characteristic (maximum)		Calculate using the measured values.														0.8	1	1.2	-
Oaj2	OSD adjusting control characteristic (minimum)	T.P35 T.P30 T.P25	a -	a -	a -	5	5	2	5	0	-	a SG8		0.5	1	1.5	V _{PP}			
ΔOaj2	Relative OSD adjusting control characteristic (minimum)		Calculate using the measured values.														0.8	1	1.2	-
OSDth	OSD input threshold voltage	T.P35 T.P30 T.P25	a -	a -	a -	5	5	2	5	1.7	-	a SG8		1.7	2.5	3.5	V _{oc}			
V1th	BLK input threshold voltage	T.P35 T.P30 T.P25	b SG4	b SG4	b SG4	5	5	2	5	-	-	a SG8	SW only b SG8	1.7	2.5	3.5	V _{oc}			

M52321SP

3-CHANNEL VIDEO PREAMPLIFIER WITH OSD MIXING FUNCTION FOR HIGH-DEFINITION COLOR DISPLAYS

ELECTRICAL CHARACTERISTIC TESTING PROCEDURE

Because signal input pin switch numbers and pulse input pin switch numbers are shown in Table of ELECTRICAL CHARACTERISTIC, we omit them in these notes. Only the switch numbers of external power supplies are named in the notes.

Sub brightness voltages V32, V27 and V22 are set to the same value, therefore, we mention only V32 in Supplementary Table of ELECTRICAL CHARACTERISTIC. Sub contrast voltages V4, V9 and V14 are also set to the same value, therefore we mention only V4 in Supplementary Table of ELECTRICAL CHARACTERISTIC.

Icc

Test conditions are as specified in Table of ELECTRICAL CHARACTERISTIC. Measure with ammeter A while SW1 is set to "a".

Vomax

Set V19 as follows :

1. Input SG1 to pin 13 (pin 8 or pin 3). Increase V19 gradually, and read voltage V19 when the T.P25(T.P30 or T.P35) output waveform peak is distorted. This reading is called VTR1(VTG1 or VTB1).
Lower V19 gradually, and read voltage V19 when the T.P25(T.P30 or T.P35) output waveform bottom is distorted. This reading is called VTR2(VTG2 or VTB2).

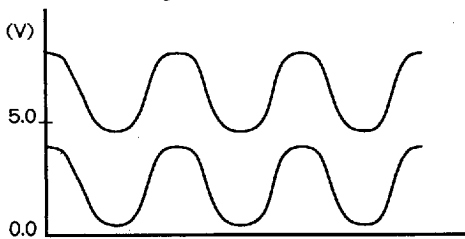

T.P25 OUTPUT WAVEFORM (T.P30 and T.P35 OUTPUT WAVEFORMS ARE THE SAME.)

2. With these readings, V_T(V_{TR}, V_{TG} and V_{TB}) can be calculated as follows :

$$V_{TR}(V_{TG}, V_{TB}) = \frac{V_{TR1}(V_{TG1}, V_{TB1}) + V_{TR2}(V_{TG1}, V_{TB1})}{2}$$

Select relevant readings, depending on the output pin. When T.P25 is measured, use V_{TR1}; when T.P30 is measured, use V_{TG1}; and when T.P35 is measured, use V_{TB1}.

3. After setting V_{TR}(V_{TG} or V_{TB}), increase SG1 amplitude gradually starting from 700mV, and read the output amplitude when T.P25(T.P30 and T.P35) output waveform peak and bottom start being distorted simultaneously.

Vimax

Starting from a condition as described in Vomax, adjust V17 to 25V as shown in Table of ELECTRICAL CHARACTERISTIC. Enlarge the input signal amplitude

gradually starting from 700mV_{P-P}, and read it when output signal starts being distorted.

Gv, ΔGv

1. Input SG1 to pin 13 (pin 8 or pin 3), and read the T.P25 (T.P30 or T.P35) output amplitude. This reading is called V_{OR1}(V_{OG1} and V_{OB1}).
2. Maximum gain Gv is :

$$Gv = 20 \log \frac{V_{OR1}(V_{OG1}, V_{OB1})}{0.7} \frac{[V_{P-P}]}{[V_{P-P}]}$$

3. Relative maximum gain ΔG can be calculated with the equation given below :

$$\Delta Gv = V_{OR1}/V_{OG1}, V_{OG1}/V_{OB1}, V_{OB1}/V_{OR1}$$

VCR1, ΔVCR1

1. The conditions are as specified in Table of ELECTRICAL CHARACTERISTIC, except that V17 is set to 2V.
2. Read the T.P25 (T.P30 or T.P35) output amplitude. This reading is called V_{OR2}(V_{OG2} or V_{OB2}).
3. Contrast control characteristic V_{CR1} and relative contrast control characteristic ΔV_{CR1} can be calculated as follows :

$$V_{CR1} = 20 \log \frac{V_{OR2}(V_{OG2}, V_{OB2})}{0.7} \frac{[V_{P-P}]}{[V_{P-P}]}$$

$$\Delta V_{CR1} = V_{OR2}/V_{OG2}, V_{OG2}/V_{OB2}, V_{OB2}/V_{OR2}$$

VCR2, ΔVCR2

1. The conditions are as specified in Table of ELECTRICAL CHARACTERISTIC, except that V17 is set to 1V.
2. Read the T.P25(T.P30 or T.P35) output amplitude. This reading is called V_{OR3}(V_{OG3} or V_{OB3}). Each voltage is called V_{CR2}.
3. Relative contrast control characteristic ΔV_{CR2} is calculated as follows :

$$\Delta V_{CR2} = V_{OR3}/V_{OG3}, V_{OG3}/V_{OB3}, V_{OB3}/V_{OR3}$$

VSCR1, ΔVSCR1

1. The conditions are as specified in Table of ELECTRICAL CHARACTERISTIC, except that V4, V9 and V14 are set to 2.0V.
2. Read the T.P25(T.P30 or T.P35) output amplitude. This reading is called V_{OR4}(V_{OG4} or V_{OB4}).
3. Sub contrast control characteristic V_{SCR1} and relative sub contrast control characteristic ΔV_{SCR1} are calculated as follows :

$$V_{SCR1} = 20 \log \frac{V_{OR4}(V_{OG4}, V_{OB4})}{0.7} \frac{[V_{P-P}]}{[V_{P-P}]}$$

$$\Delta V_{SCR1} = V_{OR4}/V_{OG4}, V_{OG4}/V_{OB4}, V_{OB4}/V_{OR4}$$



M52321SP

**3-CHANNEL VIDEO PREAMPLIFIER WITH OSD MIXING FUNCTION
FOR HIGH-DEFINITION COLOR DISPLAYS**

Vscr2, Δ Vscr2

1. The conditions are as specified in Table of ELECTRICAL CHARACTERISTIC, except that V4, V9 and V14 are set to 1.0V.
2. Read the T.P25(T.P30 or T.P35) output amplitude. This reading is called VOR5(VOG5 or VOB5).
3. Relative sub contrast characteristic Vcr2 is calculated as follows :

$$\Delta V_{CR2} = V_{OR5}/V_{OG5}, V_{OG5}/V_{OB5}, V_{OB5}/V_{OR5}$$

Vscr3, Δ Vscr3

1. The conditions are as shown in Table of ELECTRICAL CHARACTERISTIC, except that V17 is set to 3.0V, and that V4, V9 and V14 are set to 3.0V.
2. Read the T.P25(T.P30 or T.P35) output amplitude. This reading is called VOR6(VOG6 or VOB6).

$$V_{CR3} = 20 \log \frac{V_{OR6}(V_{OG6}, V_{OB6})}{0.7} \frac{[V_{P-P}]}{[V_{P-P}]}$$

$$\Delta V_{CR3} = V_{OR6}/V_{OG6}, V_{OG6}/V_{OB6}, V_{OB6}/V_{OR6}$$

Vb1, Δ Vb1

1. The conditions are as shown in Table of ELECTRICAL CHARACTERISTIC.
2. Read the T.P25(T.P30 or T.P35) output amplitude. This reading is called VOR7(VOG7 or VOB7), and is used as Vb1 at the same time.
3. The relative brightness control characteristic can be obtained by calculating the difference among channels, by using VOR7, VOG7 and VOB7.

$$\begin{aligned} \Delta V_{B1} &= V_{OR7} - V_{OG7} \quad [mV] \\ &= V_{OG7} - V_{OB7} \\ &= V_{OB7} - V_{OR7} \end{aligned}$$

Vb2, Δ Vb2

1. The conditions are as shown in Table of ELECTRICAL CHARACTERISTIC.
2. Read the T.P25(T.P30 or T.P35) output amplitude. This voltage is called VOR7'(VOG7' or VOB7'), and is Vb2 at the same time.
3. Relative brightness control characteristic Δ Vb2 can be obtained by calculating the difference among channels, by using VOR7', VOG7' and VOB7'.

$$\begin{aligned} \Delta V_{B2} &= V_{OR7'} - V_{OG7'} \quad [mV] \\ &= V_{OG7'} - V_{OB7'} \\ &= V_{OB7'} - V_{OR7'} \end{aligned}$$

Vb3, Δ Vb3

1. The conditions are as shown in Table of ELECTRICAL CHARACTERISTIC.
2. Read the T.P25(T.P30 or T.P35) output amplitude. This reading is called VOR7"(VOG7" or VOB7"), and is used as Vb3 at the same time.
3. Relative brightness control characteristic Δ Vb3 can be obtained by calculating the difference among channels, by using VOR7", VOG7" and VOB7".

$$\begin{aligned} \Delta V_{B3} &= V_{OR7''} - V_{OG7''} \quad [mV] \\ &= V_{OG7''} - V_{OB7''} \\ &= V_{OB7''} - V_{OR7''} \end{aligned}$$

Vsb1

The measuring procedure is the same as described in Vb1, Δ Vb1, except that sub brightness (V32, V27 and V22) is set to 5.0V or 0V. However, paragraph 3 of Vb1, Δ Vb1 does not apply.

Fc1, Fc1'

1. The conditions are as specified in Table of ELECTRICAL CHARACTERISTIC.
2. SG3 and SG4 are used. Measure the T.P25(T.P30 or T.P35) output waveform amplitude by the procedure as described in Gv, Δ Gv.
3. The readings are called as follows :
Output amplitude with SG1 input : VOR1(VOG1 or VOB1)
Output amplitude with SG3 input : VOR8(VOG8 or VOB8)
Output amplitude with SG4 input : VOR9(VOG9 or VOB9)
Frequency characteristics Fc1 and Fc1' can be calculated as follows :

$$F_{C1} = 20 \log \frac{V_{OR8}(V_{OG8}, V_{OB8})}{V_{OR1}(V_{OG1}, V_{OB1})} \frac{[V_{P-P}]}{[V_{P-P}]}$$

$$F_{C1'} = 20 \log \frac{V_{OR9}(V_{OG9}, V_{OB9})}{V_{OR1}(V_{OG1}, V_{OB1})} \frac{[V_{P-P}]}{[V_{P-P}]}$$

4. To obtain relative frequency bandwidths Δ Fc1 and Δ Fc1' calculate the difference between Fc1 and Fc1' for each channel.

Fc2, Δ Fc2

The measuring procedure is the same as described in Fc1, Fc1', except that CONTRAST(V17) is throttled to 1.5V.

Fc3, Δ Fc3

The measuring procedure is the same as described in Fc1, Fc1', except that CONTRAST(V17) is throttled to 0.5V.

C.T.1, C.T.1'

1. The conditions are as specified in Table of ELECTRICAL CHARACTERISTIC.
2. Input SG3 (or SG4) to pin 13 (R-ch), and measure the T.P25(T.P30 or T.P35) output waveform. The measured value is called VOR (VOG or VOB).
3. Crosstalk C.T.1 is calculated as follows :

$$C.T.1 (C.T.1') = 20 \log \frac{V_{OG} \text{ or } V_{OB}}{V_{OR}} \frac{[V_{P-P}]}{[V_{P-P}]} \quad [dB]$$

C.T.2, C.T.2'

1. Input SG2 (or SG4) to pin 8 (G-ch), and read the output in the same way as described in C.T.1, C.T.1'.
2. Crosstalk C.T.2 is calculated as follows :



M52321SP

3-CHANNEL VIDEO PREAMPLIFIER WITH OSD MIXING FUNCTION FOR HIGH-DEFINITION COLOR DISPLAYS

$$C.T.2 = 20 \log \frac{V_{OR} \text{ or } V_{OB}}{V_{OG}} \frac{[V_{P-P}]}{[V_{P-P}]} \text{ [dB]} \quad (C.T.2')$$

C.T.3, C.T.3'

1. Input SG2 (or SG4) to pin 3 (B-ch), and read the output in the same way as described in C.T.1, C.T.1'.
2. Crosstalk C.T.3 is:

$$C.T.3 = 20 \log \frac{V_{OR} \text{ or } V_{OG}}{V_{OB}} \frac{[V_{P-P}]}{[V_{P-P}]} \text{ [dB]} \quad (C.T.3')$$

Tr, Tf

1. The conditions are as specified in Table of ELECTRICAL CHARACTERISTIC.
2. Measure rise time T_{r1} , during which an input pulse rises from 10% to 90%. Also measure fall time T_{f1} , during which an input pulse falls from 90% to 10%. Use an active probe for this measurement.
3. Measure rise time T_{r2} , during which an output pulse rises from 10% to 90%, and measure fall time T_{f2} during which an output pulse falls from 90% to 10%. Use an active probe for this measurement.
4. Pulse characteristics T_r and T_f are calculated as follows:

$$T_r(ns) = \sqrt{(T_{r2})^2 - (T_{r1})^2}$$

$$T_f(ns) = \sqrt{(T_{f2})^2 - (T_{f1})^2}$$

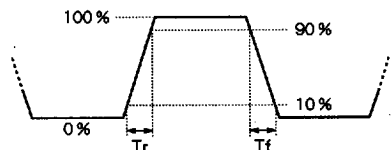

V14th

1. The conditions are as specified in Table of ELECTRICAL CHARACTERISTIC.
2. Monitoring output (approximately 2.0Vdc), lower the SG6 level gradually, and read the SG6 level when output is 0V.

W14

Under the same conditions as described in V14th, reduce the SG6 pulse width gradually, while monitoring output. Measure the SG6 pulse width when output is 0V.

PbcH, PbcL

1. The conditions are as specified in Table of ELECTRICAL CHARACTERISTIC.
2. Measure pedestal voltage at room temperature. The measurement is called Pbc1.
3. Measure pedestal voltage at -20°C and at 85°C. The measurements are called, respectively, Pbc2 and Pbc3.
4. $P_{bcH} = P_{bc1} - P_{bc2}$
 $P_{bcL} = P_{bc1} - P_{bc3}$

OTr, OTf

1. The conditions are as specified in Table of ELECTRICAL CHARACTERISTIC.
2. Measure rise time OT_r and fall time OT_f , during both of which an output pulse changes between 10% and 90%, using an active probe.

Oaj1, Δ Oaj1

1. The conditions are as specified in Table of ELECTRICAL CHARACTERISTIC.
2. Read the T.P25(T.P30 and T.P35) output amplitude. The reading is called V_{ORA} (V_{OGA} or V_{OBA}). Each reading is used as O_{aj1} .
3. Relative OSD adjusting control characteristic ΔO_{aj1} is calculated as follows:
 $\Delta O_{aj1} = V_{ORA}/V_{OGA}, V_{OGA}/V_{OBA}, V_{OBA}/V_{ORA}$

Oaj2, Δ Oaj2

1. The conditions are as specified in Table of ELECTRICAL CHARACTERISTIC, except that V36 is set to 0V.
2. Read the T.P25(T.P30 and T.P35) output amplitude. The reading is called V_{ORB} (V_{OGB} or V_{OBB}). Each reading is used as O_{aj2} .
3. Relative OSD adjusting control characteristic ΔO_{aj2} is calculated as follows:
 $\Delta O_{aj2} = V_{ORB}/V_{OGA}, V_{OGA}/V_{OBA}, V_{OBA}/V_{ORA}$

OSDth

1. The conditions are as specified in Table of ELECTRICAL CHARACTERISTIC.
2. Monitoring output, lower the SG8 level, and read the SG8 level when there is no output. The measurement is called OSDth.





V1th

1. The conditions are as specified in Table of ELECTRICAL CHARACTERISTIC.
2. Check that no signal is output synchronously with SG8. (Blanking period)
3. Monitoring output, lower the SG8 level, and measure the SG8 level when there is no blanking period. The measurement is called V1th.

M52321SP

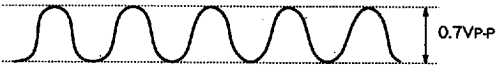
**3-CHANNEL VIDEO PREAMPLIFIER WITH OSD MIXING FUNCTION
FOR HIGH-DEFINITION COLOR DISPLAYS**

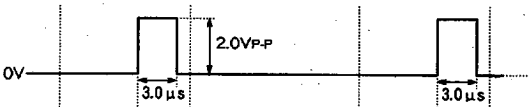
INPUT SIGNALS

SG No.	Signal connects
SG1	Sine wave of amplitude 0.7V _{P-P} (100kHz, amplitude variable partially*) 
SG2	Sine wave of amplitude 0.7V _{P-P} (f = 10MHz)
SG3	Sine wave of amplitude 0.7V _{P-P} (f = 50MHz)
SG4	Sine wave of amplitude 0.7V _{P-P} (f = 100MHz)
SG5	Pulse of amplitude 0.7V _{P-P} (f = 1MHz, duty = 50%) 
SG6	Pulse of 2.0V _{P-P} in amplitude and 3.0μs in width. This pulse is synchronous with a standard step form wave pedestal.(Pulse width : variable) 
SG7 standard video step form wave	
SG8 BLK signal and OSD signal	Pulse of 4.0V _{P-P} in amplitude and 50μs in width. This pulse is synchronous with standard step form wave video portions. 

M52321SP

3-CHANNEL VIDEO PREAMPLIFIER WITH OSD MIXING FUNCTION FOR HIGH-DEFINITION COLOR DISPLAYS

TYPICAL CHARACTERISTICS

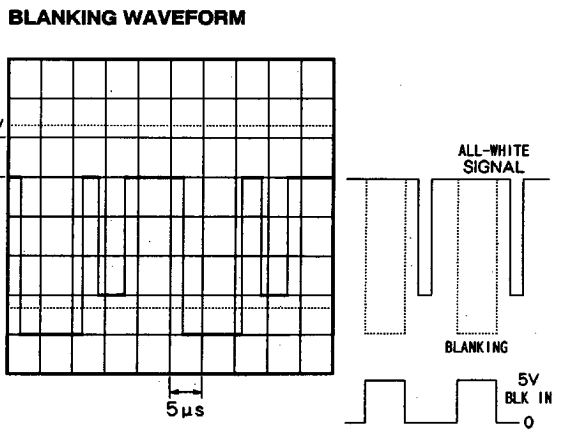
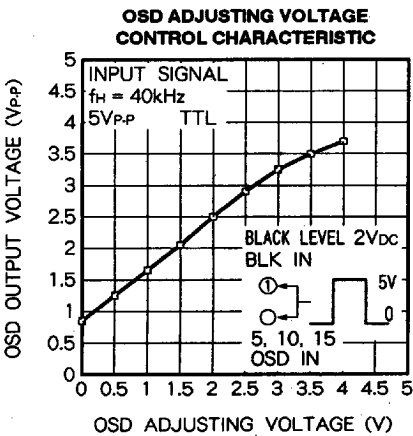
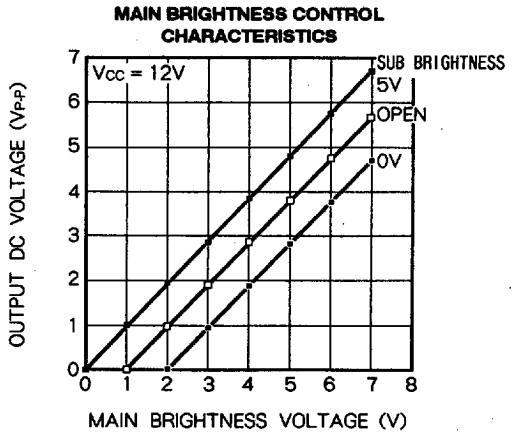
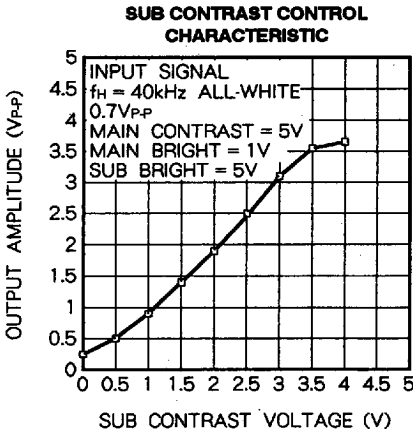
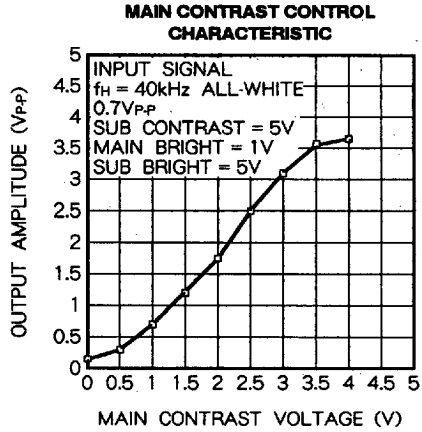
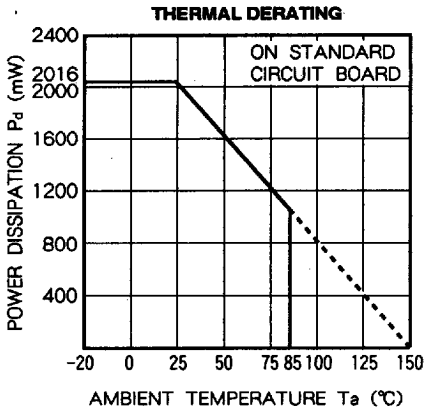

M52321SP

**3-CHANNEL VIDEO PREAMPLIFIER WITH OSD MIXING FUNCTION
FOR HIGH-DEFINITION COLOR DISPLAYS**

Pulse Response

1. Input signal $f_H = 40\text{kHz}$, all-white, $0.7V_{P-P}$ VG-819
 Oscilloscope Iwatsu SS6521 (up to 500MHz)
 Probe Tektronix P6202A

(a) T_r

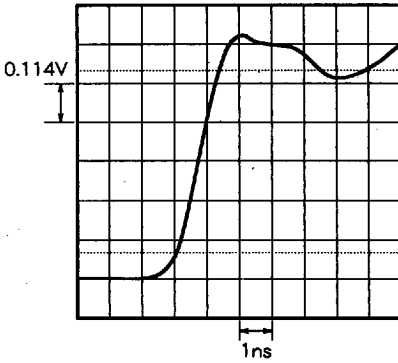

(b) T_f

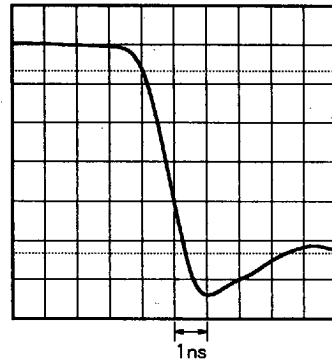

2. Output signal
 Output voltage = $3V_{P-P}$
 Black level $2V_{DC}$

(a) T_r

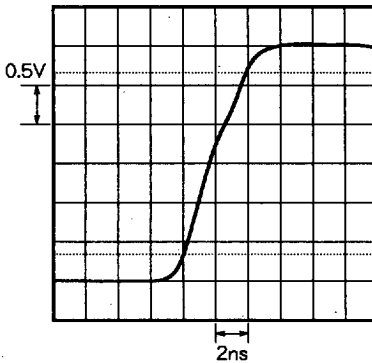

(b) T_f

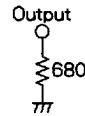
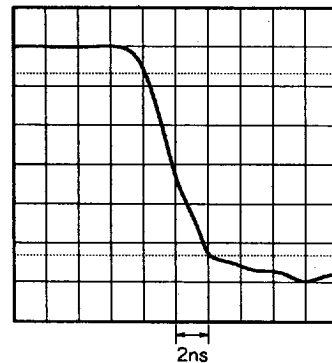

Pulse Response (BLK)

1. Input signal $f_H = 40\text{kHz}$, all-white, $0.7V_{P-P}$ VG-819
 Oscilloscope Iwatsu SS6521 (up to 500MHz)
 Probe Tektronix P6202A

(a) T_r

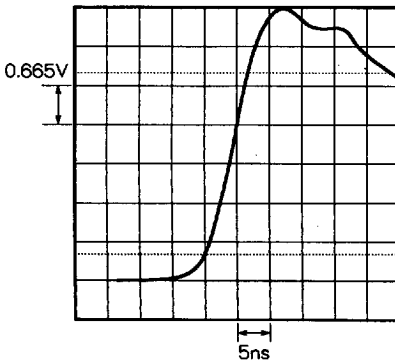

(b) T_f

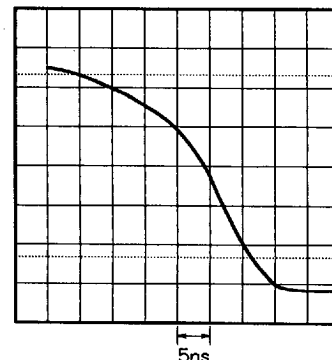

M52321SP

3-CHANNEL VIDEO PREAMPLIFIER WITH OSD MIXING FUNCTION FOR HIGH-DEFINITION COLOR DISPLAYS

2. Output signal
Black level 2V_{DC}

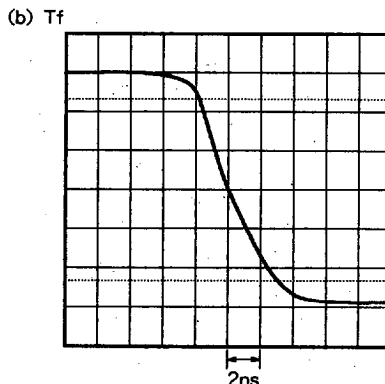
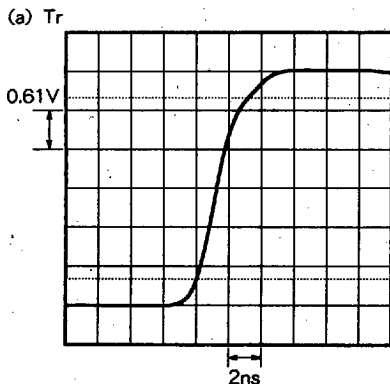
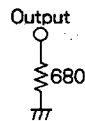

Pulse Response (OSD)

1. Input signal $f_H = 40\text{kHz}$, all-whites, 0.7V_{P-P} VG-819
Oscilloscope Iwatsu SS6521 (up to 500MHz)
Probe Tektronix P6202A

2. Output
(Black level = 2V_{DC})

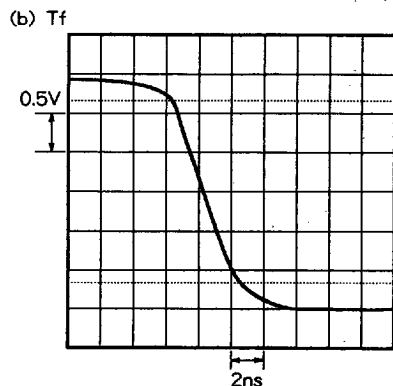
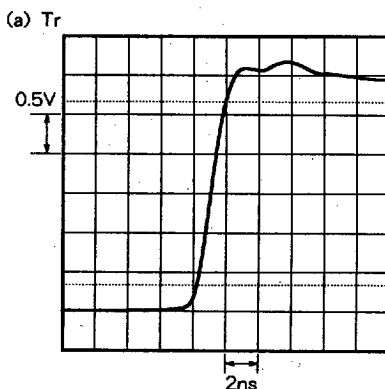
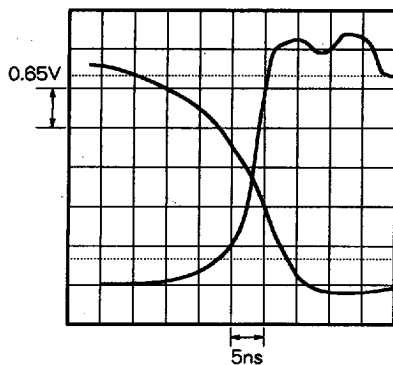
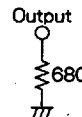

M52321SP

3-CHANNEL VIDEO PREAMPLIFIER WITH OSD MIXING FUNCTION FOR HIGH-DEFINITION COLOR DISPLAYS

APPLICATION EXAMPLE

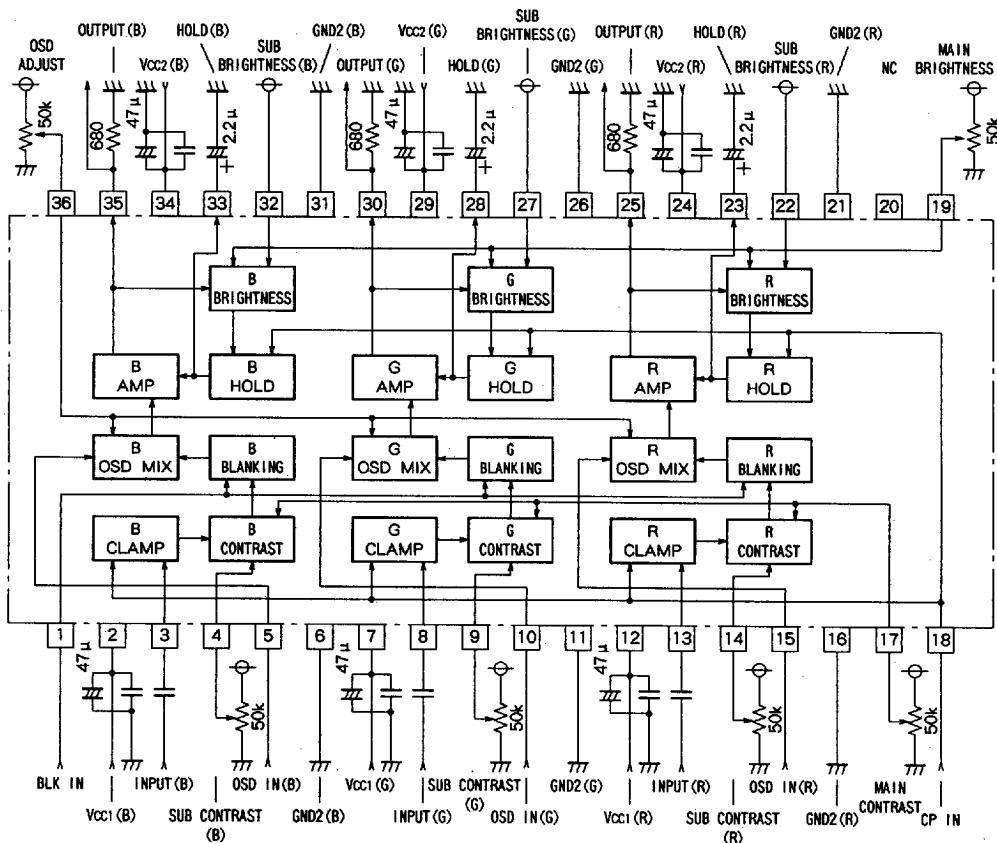

※ Capacitance is 0.01 μ F unless otherwise specified
 ⊕ : 5V

Units Resistance : Ω
 Capacitance : F

M52321SP

3-CHANNEL VIDEO PREAMPLIFIER WITH OSD MIXING FUNCTION FOR HIGH-DEFINITION COLOR DISPLAYS

DESCRIPTION OF PIN

Pin No.	Name	DC voltage(V)	Peripheral circuit	Remarks
①	BLK IN	-		<ul style="list-style-type: none"> ● Input pulse signals of no less than 3V. <ul style="list-style-type: none"> ● Earth to GND when this pin is not used.
② ⑦ ⑫	Vcc (B-ch) Vcc (G-ch) Vcc (R-ch)	12	-	<ul style="list-style-type: none"> ● Apply the same level of voltage to 3 channels.
③ ⑧ ⑬	INPUT (B) INPUT (G) INPUT (R)	2.5		<ul style="list-style-type: none"> ● Clamped to approximately 2.5V due to pin ⑩ clamp pulse signals. ● Input at low impedance.
④ ⑨ ⑭	SUB CONTRAST (B) SUB CONTRAST (G) SUB CONTRAST (R)	2.5		<ul style="list-style-type: none"> ● Apply 5V or less for stable operation.
⑤ ⑩ ⑮	OSD IN (B) OSD IN (G) OSD IN (R)	-		<ul style="list-style-type: none"> ● Apply pulse signals of between 3V and 5V. <ul style="list-style-type: none"> ● Earth to GND when this pin is not used.
⑥、⑪ ⑬、⑱ ⑮、⑳	GND (B-ch) GND (G-ch) GND (R-ch)	GND	-	

M52321SP

3-CHANNEL VIDEO PREAMPLIFIER WITH OSD MIXING FUNCTION FOR HIGH-DEFINITION COLOR DISPLAYS

DESCRIPTION OF PIN (cont.)

Pin No.	Name	DC voltage(V)	Peripheral circuit	Remarks
⑰	MAIN CONTRAST	2.5		<ul style="list-style-type: none"> ● Apply 5V or less for stable operation.
⑱	CP IN	-		<ul style="list-style-type: none"> ● Input pulse signals of no less than 2.2V <ul style="list-style-type: none"> ● Input at low impedance.
⑲	MAIN BRIGHTNESS	-		
⑳	NC	-	-	<ul style="list-style-type: none"> ● Earth to GND or set to OPEN normally.
㉑ ㉒ ㉓	SUB BRIGHTNESS (R) SUB BRIGHTNESS (G) SUB BRIGHTNESS (B)	2.8		<ul style="list-style-type: none"> ● Pull up to Vcc when this pin is not used.
㉔ ㉕ ㉖	HOLD (R) HOLD (G) HOLD (B)	Variable		

M52321SP

**3-CHANNEL VIDEO PREAMPLIFIER WITH OSD MIXING FUNCTION
FOR HIGH-DEFINITION COLOR DISPLAYS**

DESCRIPTION OF PIN (cont.)

Pin No.	Name	DC voltage (V)	Peripheral circuit	Remarks
② ③ ④	Vcc2 (R) Vcc2 (G) Vcc2 (B)	12 Apply		<ul style="list-style-type: none"> ● Used exclusively for output emitter follower. ● Apply the same level of voltage to 3 channels.
⑤ ⑥ ⑦	OUTPUT (R) OUTPUT (G) OUTPUT (B)	Variable		<ul style="list-style-type: none"> ● Connect resistance to GND such that the amperage will be no more than 15mA with necessary driving capacity.
⑧	OSD ADJUST	Apply		