

GaAs N-channel Dual Gate MES FET

Description

The 3SK165A is an N-channel dual gate GaAs MES FET for UHF band low-noise amplification. This FET is suitable for a wide range of applications including cellular, cordless phone.

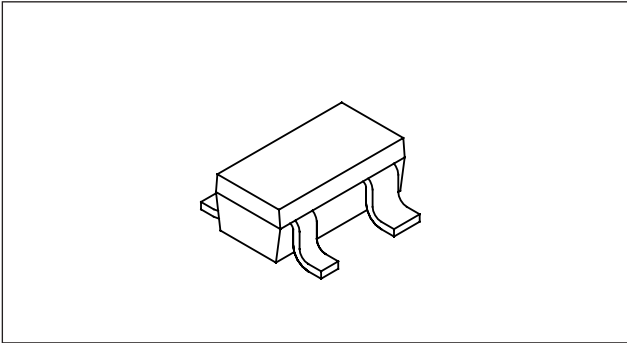

Features

- Low voltage operation
- Low noise: NF = 1.2dB (typ.) at 800MHz
- High gain: Ga = 20dB (typ) at 800MHz
- High stability

Application

UHF band amplifier, mixer and oscillator

Structure

GaAs N-channel dual-gate metal semiconductor field-effect transistor

Absolute Maximum Ratings (Ta = 25°C)

• Drain to source voltage	V _{DSX}	8	V
• Gate 1 to source voltage	V _{G1S}	-6	V
• Gate 2 to source voltage	V _{G2S}	-6	V
• Drain current	I _D	80	mA
• Allowable power dissipation	P _D	150	mW
• Channel temperature	T _{ch}	150	°C
• Storage temperature	T _{stg}	-55 to +150	°C

Sony reserves the right to change products and specifications without prior notice. This information does not convey any license by any implication or otherwise under any patents or other right. Application circuits shown, if any, are typical examples illustrating the operation of the devices. Sony cannot assume responsibility for any problems arising out of the use of these circuits.

Electrical Characteristics

(Ta = 25°C)

Item	Symbol	Condition	Min.	Typ.	Max.	Unit
Drain cut-off current	I _{DSX}	V _{DS} = 8V V _{G1S} = -4V V _{G2S} = 0V			100	μA
Gate 1 to source current	I _{G1SS}	V _{G1S} = -4V V _{G2S} = 0V V _{DS} = 0V			-20	μA
Gate 2 to source current	I _{G2SS}	V _{G2S} = -4V V _{G1S} = 0V V _{DS} = 0V			-20	μA
Drain saturation current	I _{DSS}	V _{DS} = 5V V _{G1S} = 0V V _{G2S} = 0V	20		55	mA
Gate 1 to source cut-off voltage	V _{G1S} (OFF)	V _{DS} = 5V I _D = 100μA V _{G2S} = 0V	-1		-4	V
Gate 2 to source cut-off voltage	V _{G2S} (OFF)	V _{DS} = 5V I _D = 100μA V _{G1S} = 0V	-1		-4	V
Forward transfer admittance	g _m	V _{DS} = 5V I _D = 10mA V _{G2S} = 1.5V f = 1kHz	15	22		ms
Input capacitance	C _{iss}	V _{DS} = 5V I _D = 10mA V _{G2S} = 1.5V f = 1MHz		0.5	1.0	pF
Feedback capacitance	C _{rss}			7.5	25	fF
Noise figure	NF	V _{DS} = 5V I _D = 10mA V _{G2S} = 1.5V f = 800MHz		1.2	2.5	dB
Associated gain	G _a		16	20		dB

* I_{DSS} classification

Product name classification	I _{DSS} RANK
3SK165A-0	20 to 55mA
3SK165A-1	20 to 35mA

Typical Characteristics (Ta = 25°C)

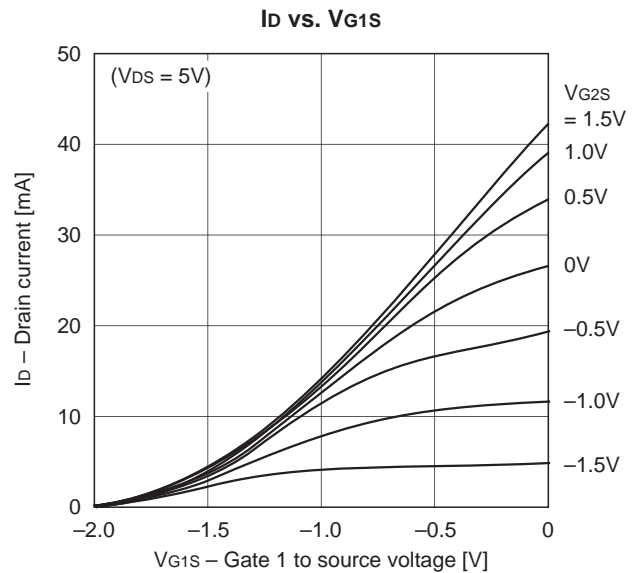
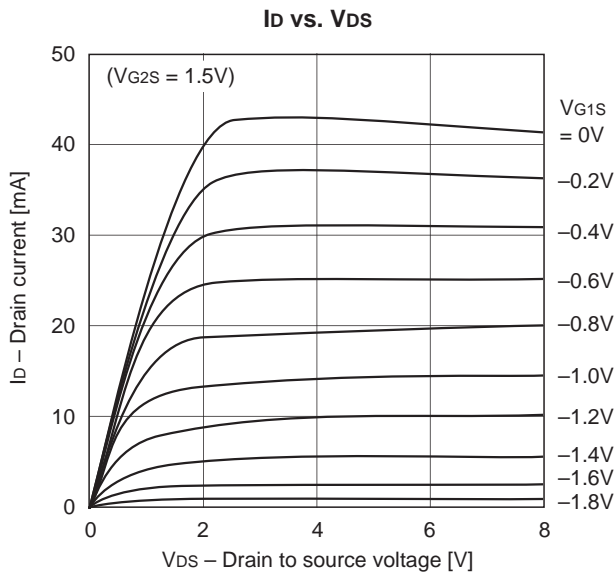

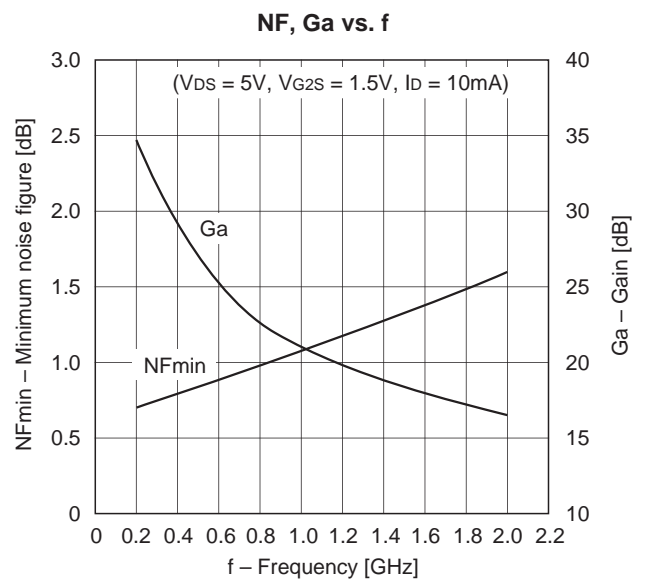
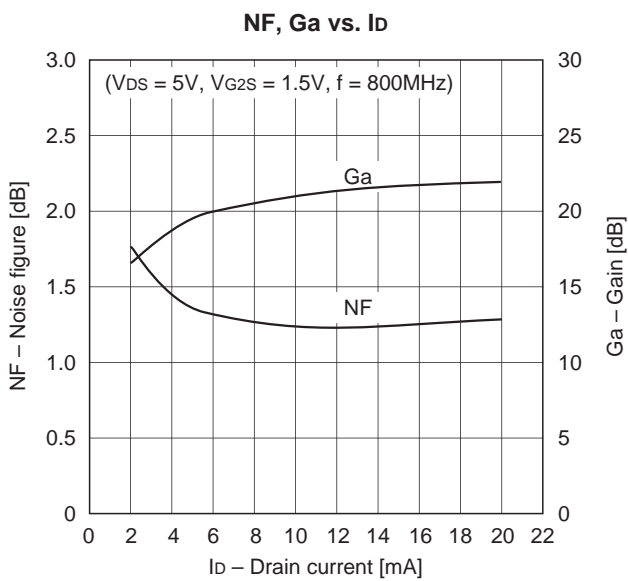
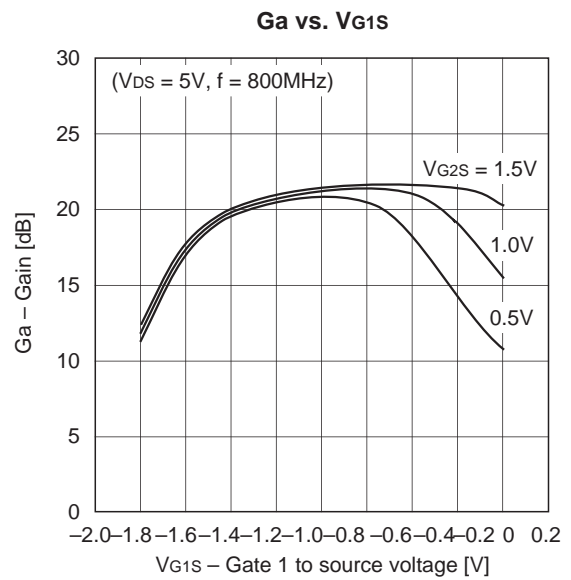
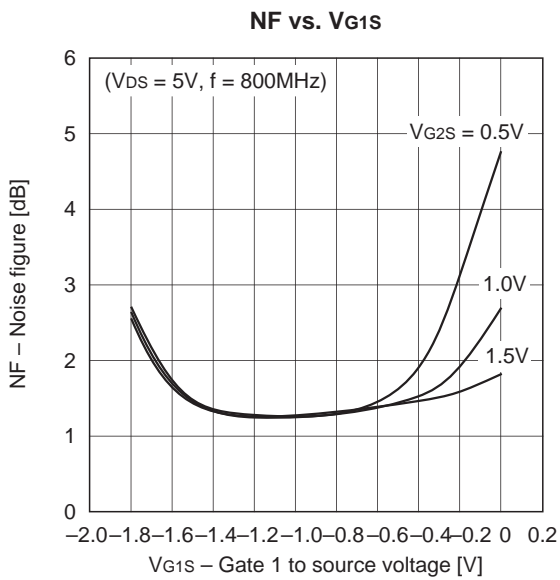
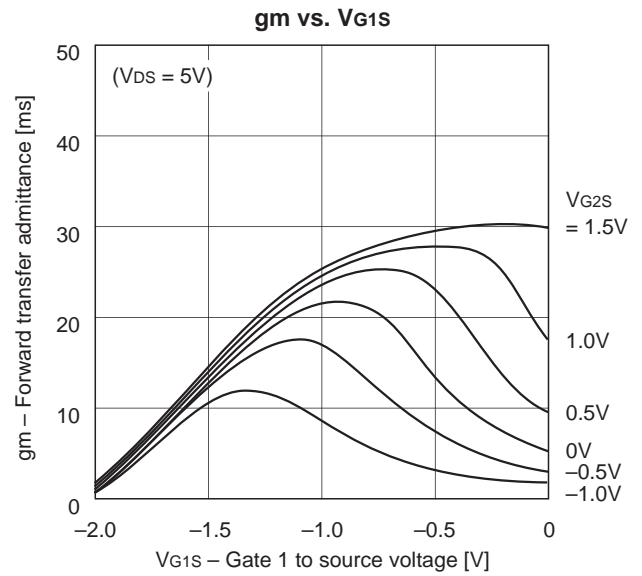
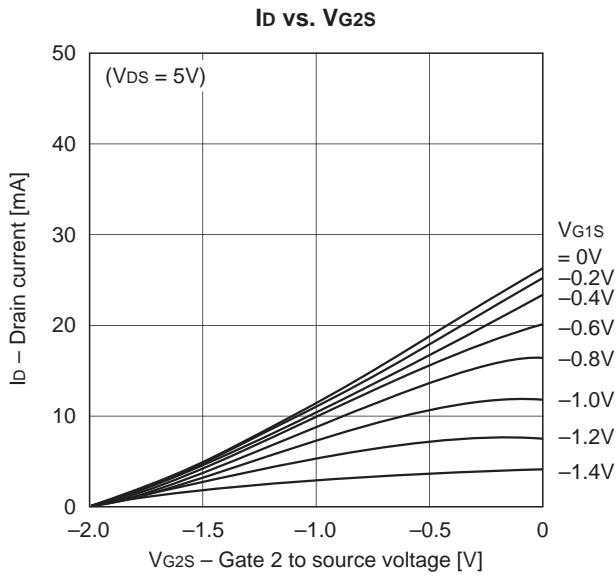

S-parameter vs. Frequency Characteristics ($V_{DS} = 5V$, $V_{G2S} = 1.5V$, $I_D = 10mA$)

($Z_0 = 50\Omega$)

f (MHz)	S11		S21		S12		S22	
	MAG	ANG	MAG	ANG	MAG	ANG	MAG	ANG
100	0.999	-1.8	2.110	176.7	0.001	73.3	0.970	-0.7
200	0.998	-3.7	2.105	173.0	0.002	91.6	0.968	-1.6
300	0.991	-5.7	2.097	169.7	0.004	80.5	0.965	-2.4
400	0.984	-7.8	2.094	166.4	0.004	85.0	0.963	-3.2
500	0.980	-10.0	2.083	162.7	0.005	84.9	0.961	-4.2
600	0.970	-12.2	2.070	159.5	0.006	84.7	0.958	-4.9
700	0.964	-14.1	2.058	156.1	0.007	83.2	0.958	-5.8
800	0.956	-16.1	2.048	152.8	0.007	82.5	0.958	-6.7
900	0.949	-17.9	2.039	149.4	0.008	82.0	0.958	-7.3
1000	0.938	-19.7	2.021	146.0	0.008	78.1	0.958	-8.3
1100	0.927	-21.3	2.008	142.8	0.009	84.4	0.954	-9.0
1200	0.911	-22.8	1.990	139.6	0.010	76.7	0.953	-9.6
1300	0.898	-24.4	1.973	136.3	0.011	77.8	0.950	-10.5
1400	0.882	-25.8	1.954	133.3	0.011	80.9	0.949	-11.2
1500	0.868	-27.4	1.941	130.0	0.011	80.0	0.947	-12.1
1600	0.856	-29.0	1.928	126.8	0.011	80.5	0.947	-12.9
1700	0.838	-30.2	1.901	123.7	0.012	74.3	0.946	-13.9
1800	0.824	-31.5	1.888	120.6	0.012	79.2	0.945	-14.5
1900	0.809	-32.9	1.865	117.3	0.013	80.6	0.942	-15.3
2000	0.792	-34.1	1.846	114.1	0.013	79.5	0.941	-15.9

Noise Figure Characteristics ($V_{DS} = 5V$, $V_{G2S} = 1.5V$, $I_D = 10mA$)

f (MHz)	NFmin (dB)	Gamma Optimum		Rn (Ω)
		ANG	MAG	
200	0.72	0.97	4.4	63.7
300	0.75	0.95	6.4	63.0
400	0.81	0.93	8.2	62.2
500	0.84	0.91	9.9	61.5
600	0.90	0.88	11.4	60.7
700	0.94	0.86	12.8	59.9
800	0.98	0.84	14.2	59.1
900	1.02	0.83	15.5	58.4
1000	1.07	0.81	16.7	57.6
1100	1.13	0.80	17.9	56.8
1200	1.17	0.79	19.1	56.0
1300	1.22	0.78	20.3	55.2
1400	1.26	0.78	21.5	54.3
1500	1.31	0.77	22.8	53.5
1600	1.38	0.77	24.2	52.7
1700	1.42	0.77	25.6	51.9
1800	1.48	0.76	27.1	51.0
1900	1.52	0.76	28.8	50.2
2000	1.57	0.75	30.6	49.3

Package Outline

Unit: mm

M-254

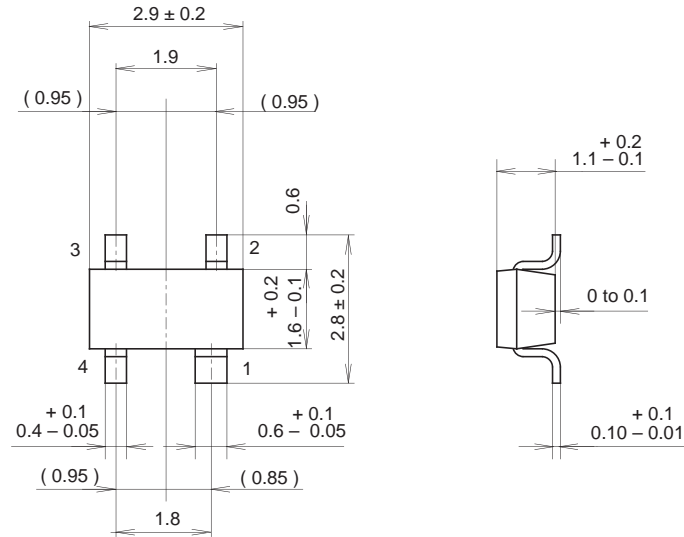

- 1. Source
- 2. Gate1
- 3. Gate2
- 4. Drain

SONY CODE	M-254
EIAJ CODE	_____
JEDEC CODE	_____

PACKAGE MASS	0.01g
--------------	-------