

200 Volt, 0.40Ω HEXFET

HEXFET technology is the key to International Rectifier's advanced line of power MOSFET transistors. The efficient geometry achieves very low on-state resistance combined with high transconductance.

HEXFET transistors also feature all of the well-established advantages of MOSFETs, such as voltage control, very fast switching, ease of paralleling and electrical parameter temperature stability. They are well-suited for applications such as switching power supplies, motor controls, inverters, choppers, audio amplifiers, and high energy pulse circuits, and virtually any application where high reliability is required.

Product Summary

Part Number	BV _{DSS}	R _{Ds(on)}	I _D
JANTX2N6758	200V	0.40Ω	9A
JANTXV2N6758			

Features:

- Avalanche Energy Rating
- Dynamic dv/dt Rating
- Simple Drive Requirements
- Ease of Paralleling
- Hermetically Sealed

Absolute Maximum Ratings

	Parameter	JANTX2N6758, JANTXV2N6758	Units
I _D @ V _{GS} = 10V, T _C = 25°C	Continuous Drain Current	9	A
I _D @ V _{GS} = 10V, T _C = 100°C	Continuous Drain Current	6	
I _{DM}	Pulsed Drain Current ①	36	
P _D @ T _C = 25°C	Max. Power Dissipation	75	W
	Linear Derating Factor	0.60	W/K ⑤
V _{GS}	Gate-to-Source Voltage	±20	V
E _{AS}	Single Pulse Avalanche Energy ②	54	mJ
I _{AR}	Avalanche Current ①	9	A
E _{AR}	Repetitive Avalanche Energy ①	7.5	mJ
dv/dt	Peak Diode Recovery dv/dt ③	5.0	V/ns
T _J	Operating Junction	-55 to 150	°C
T _{STG}	Storage Temperature Range		
	Lead Temperature	300 (0.063 in. (1.6mm) from case for 10.5 seconds)	
	Weight	11.5 (typical)	

JANTX2N6758, JANTXV2N6758 Device

Electrical Characteristics @ Tj = 25°C (Unless Otherwise Specified)

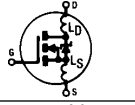
	Parameter	Min.	Typ.	Max.	Units	Test Conditions
BV_{DSS}	Drain-to-Source Breakdown Voltage	200	—	—	V	$V_{GS} = 0V, I_D = 1.0 \text{ mA}$
$\Delta BV_{DSS}/\Delta T_J$	Temperature Coefficient of Breakdown Voltage	—	0.29	—	V/°C	Reference to 25°C, $I_D = 1.0 \text{ mA}$
RDS(on)	Static Drain-to-Source	—	—	0.40	Ω	$V_{GS} = 10V, I_D = 6.0A \text{ ④}$
	On-State Resistance	—	—	0.49		$V_{GS} = 10V, I_D = 9.0A$
$V_{GS(th)}$	Gate Threshold Voltage	2.0	—	4.0	V	$V_{DS} = V_{GS}, I_D = 250\mu A$
g_{fs}	Forward Transconductance	3.0	—	—	S (r)	$V_{DS} > 15V, I_{DS} = 6.0A \text{ ④}$
IDSS	Zero Gate Voltage Drain Current	—	—	25	μA	$V_{DS} = 0.8 \times \text{Max Rating}, V_{GS} = 0V$
		—	—	250		$V_{DS} = 0.8 \times \text{Max Rating}, V_{GS} = 0V, T_J = 125^\circ C$
IGSS	Gate-to-Source Leakage Forward	—	—	100	nA	$V_{GS} = 20V$
IGSS	Gate-to-Source Leakage Reverse	—	—	-100	nA	$V_{GS} = -20V$
Qg	Total Gate Charge	16	—	39	nC	$V_{GS} = 10V, I_D = 9.0A$
Qgs	Gate-to-Source Charge	3.0	—	5.7		$V_{DS} = \text{Max. Rating} \times 0.5$
Qgd	Gate-to-Drain ("Miller") Charge	8.0	—	20		see figures 6 and 13
td(on)	Turn-On Delay Time	—	—	35	ns	$V_{DD} = 100V, I_D = 9.0A,$ $R_G = 7.5\Omega, V_{GS} = 10V$
tr	Rise Time	—	—	80		
td(off)	Turn-Off Delay Time	—	—	60		
tf	Fall Time	—	—	40		
LD	Internal Drain Inductance	—	5.0	—	nH	<p>Measured from the drain lead, 6mm (0.25 in.) from package to center of die.</p> <p>Modified MOSFET symbol showing the internal inductances.</p> 
LS	Internal Source Inductance	—	13.0	—		
Ciss	Input Capacitance	—	600	—	pF	$V_{GS} = 0V, V_{DS} = 25V$ $f = 1.0 \text{ MHz}$ see figure 5
Coss	Output Capacitance	—	250	—		
Crss	Reverse Transfer Capacitance	—	80	—		

Source-Drain Diode Ratings and Characteristics

	Parameter	Min.	Typ.	Max.	Units	Test Conditions
IS	Continuous Source Current (Body Diode)	—	—	9	A	Modified MOSFET symbol showing the integral reverse p-n junction rectifier.
ISM	Pulse Source Current (Body Diode) ①	—	—	36		
VSD	Diode Forward Voltage	—	—	1.4	V	$T_J = 25^\circ C, I_S = 9.0A, V_{GS} = 0V \text{ ④}$
trr	Reverse Recovery Time	—	—	500	ns	$T_J = 25^\circ C, I_F = 9.0A, di/dt \leq 100A/\mu s$ $V_{DD} \leq 50V \text{ ④}$
QRR	Reverse Recovery Charge	—	—	6.0	μC	
ton	Forward Turn-On Time	Intrinsic turn-on time is negligible. Turn-on speed is substantially controlled by LS + LD.				

Thermal Resistance

	Parameter	Min.	Typ.	Max.	Units	Test Conditions
RthJC	Junction-to-Case	—	—	1.67	K/W	Typical socket mount
RthJA	Junction-to-Ambient	—	—	30		

JANTX2N6758, JANTXV2N6758 Device

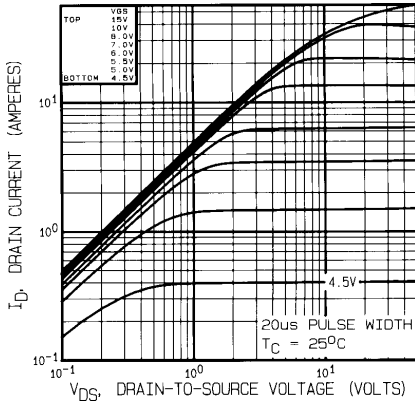

Fig. 1 — Typical Output Characteristics
 $T_C = 25^\circ\text{C}$

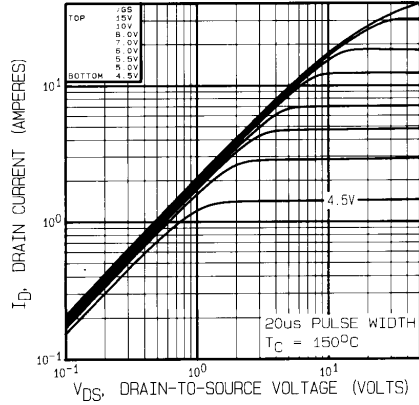

Fig. 2 — Typical Output Characteristics
 $T_C = 150^\circ\text{C}$

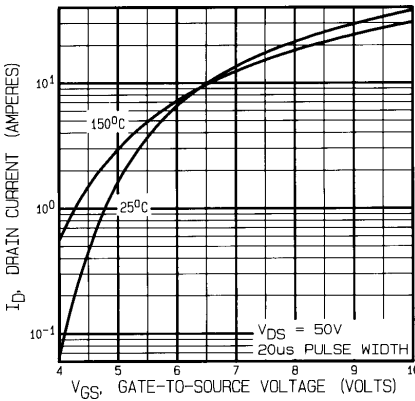

Fig. 3 — Typical Transfer Characteristics

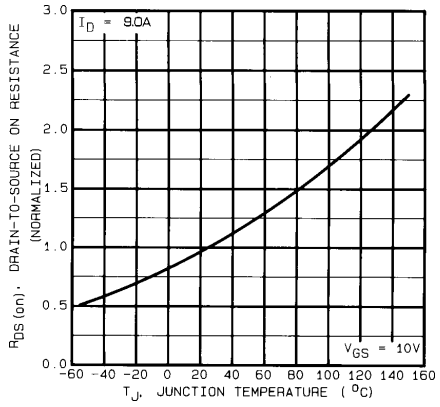

Fig. 4 — Normalized On-Resistance Vs. Temperature

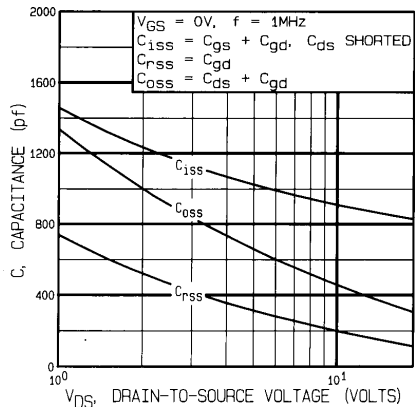

Fig. 5 — Typical Capacitance Vs. Drain-to-Source Voltage

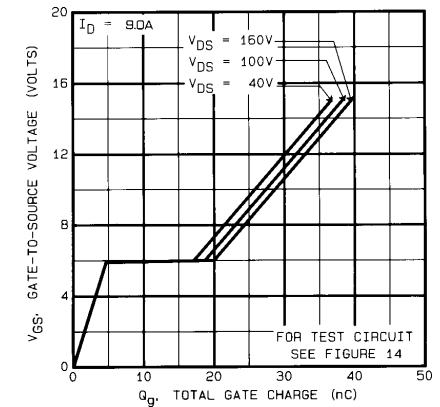

Fig. 6 — Typical Gate Charge Vs. Gate-to-Source Voltage

JANTX2N6758, JANTXV2N6758 Device

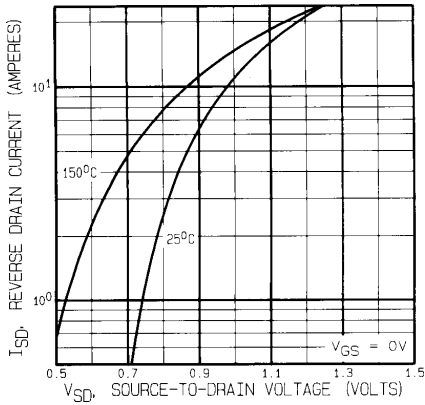

Fig. 7 — Typical Source-to-Drain Diode Forward Voltage

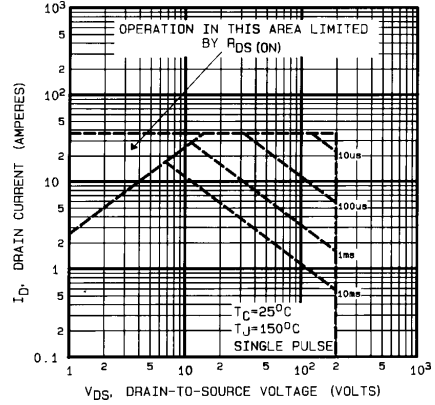

Fig. 8 — Maximum Safe Operating Area

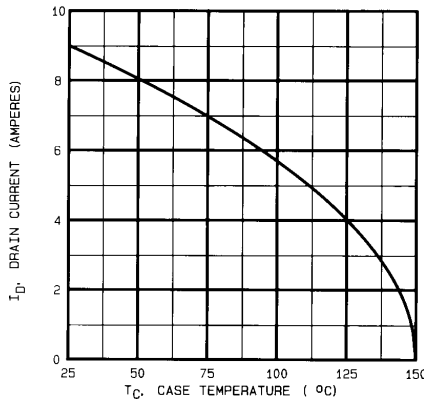

Fig. 9 — Maximum Drain Current Vs. Case Temperature

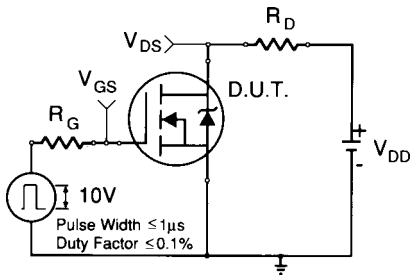

Fig. 10a — Switching Time Test Circuit

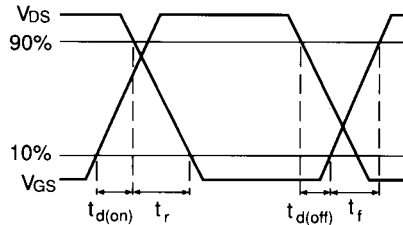

Fig. 10b — Switching Time Waveforms

JANTX2N6758, JANTXV2N6758 Device

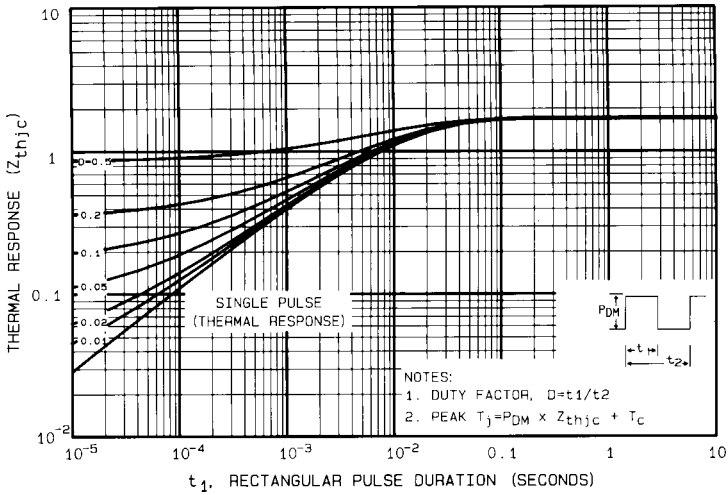

Fig. 11 — Maximum Effective Transient Thermal Impedance, Junction-to-Case Vs. Pulse Duration

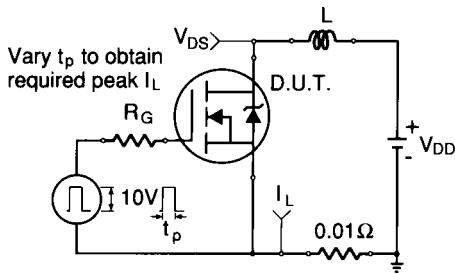

Fig. 12a — Unclamped Inductive Test Circuit

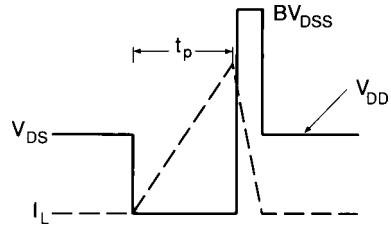

Fig. 12b — Unclamped Inductive Waveforms

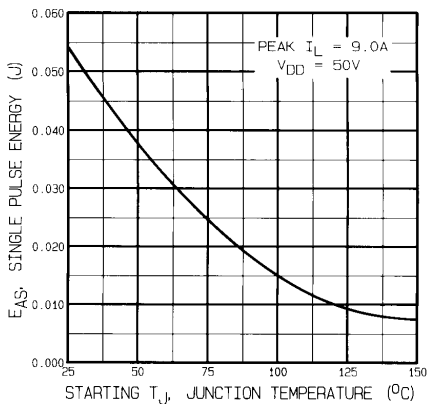

Fig. 12c — Max. Avalanche Energy vs. Current

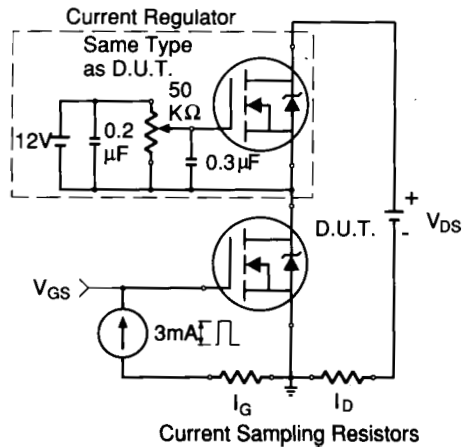

Fig. 13a — Gate Charge Test Circuit

JANTX2N6758, JANTXV2N6758 Device

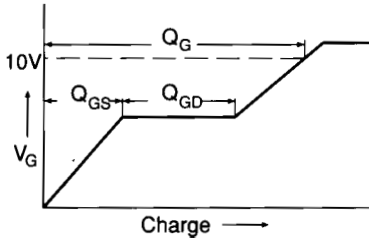
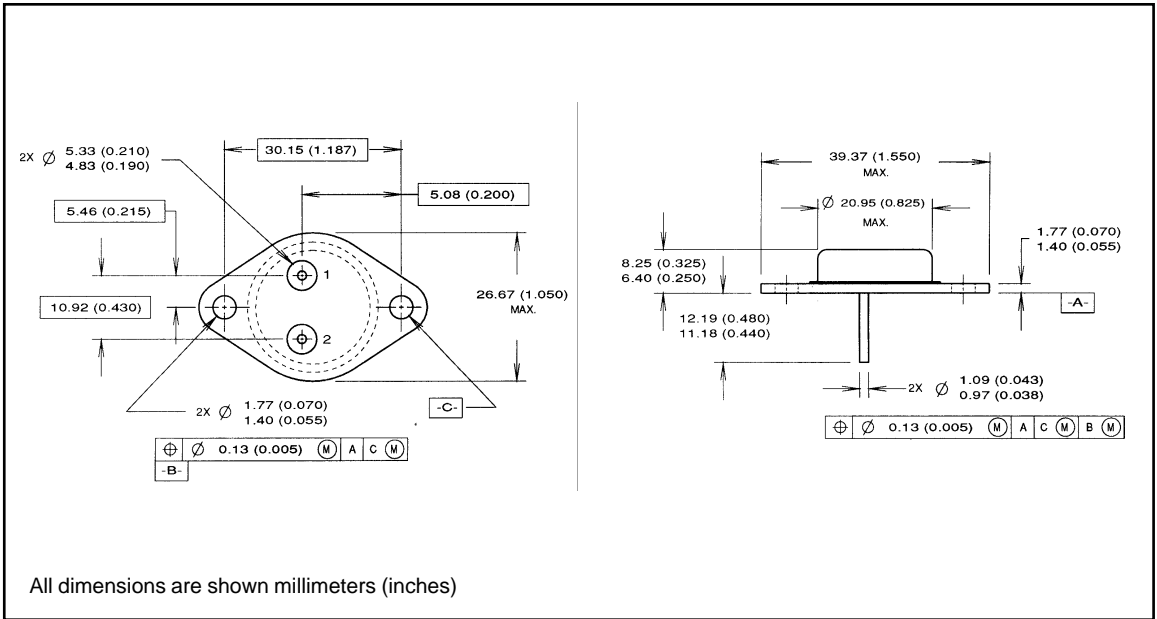

Fig. 13b — Basic Gate Charge Waveform

- ① Repetitive Rating; Pulse width limited by maximum junction temperature. (see figure 11)
- ② @ $V_{DD} = 50V$, Starting $T_J = 25^\circ C$,
 $EAS = [0.5 * L * (I_L^2) * [BV_{DSS}/(BV_{DSS}-V_{DD})]$
 Peak $I_L = 9A$, $V_{GS} = 10V$, $25 \leq R_G \leq 200\Omega$
- ③ $I_{SD} \leq 9A$, $di/dt \leq 120A/\mu s$,
 $V_{DD} \leq BV_{DSS}$, $T_J \leq 150^\circ C$
- ④ Pulse width $\leq 300 \mu s$; Duty Cycle $\leq 2\%$
- ⑤ $K/W = ^\circ C/W$
 $W/K = W/^\circ C$

Case Outline and Dimensions — TO-204AA (Modified TO-3)



International
IR Rectifier

WORLD HEADQUARTERS: 233 Kansas St., El Segundo, California 90245, Tel: (310) 322 3331
EUROPEAN HEADQUARTERS: Hurst Green, Oxted, Surrey RH8 9BB, UK Tel: ++ 44 1883 732020
IR CANADA: 7321 Victoria Park Ave., Suite 201, Markham, Ontario L3R 2Z8, Tel: (905) 475 1897
IR GERMANY: Saalburgstrasse 157, 61350 Bad Homburg Tel: ++ 49 6172 96590
IR ITALY: Via Liguria 49, 10071 Borgaro, Torino Tel: ++ 39 11 451 0111
IR FAR EAST: K&H Bldg., 2F, 3-30-4 Nishi-Ikeburo 3-Chome, Toshima-Ki, Tokyo Japan 171 Tel: 81 3 3983 0086
IR SOUTHEAST ASIA: 315 Outram Road, #10-02 Tan Boon Liat Building, Singapore 0316 Tel: 65 221 8371
<http://www.irf.com/> Data and specifications subject to change without notice. 10/96