

# DATA SHEET

## **TDA3561A** PAL decoder

Product specification  
File under Integrated Circuits, IC02

September 1982

**PAL decoder****TDA3561A****GENERAL DESCRIPTION**

The TDA3561A is a decoder for the PAL colour television standard. It combines all functions required for the identification and demodulation of PAL signals. Furthermore it contains a luminance amplifier, an RGB-matrix and amplifier. These amplifiers supply output signals up to 5 V peak-to-peak (picture information) enabling direct drive of the discrete output stages. The circuit also contains separate inputs for data insertion, analogue as well as digital, which can be used for text display systems (e.g. (Teletext/broadcast antiope), channel number display, etc. Additional to the TDA3560, the circuit includes the following features:

- The peak white limiter is only active during the time that the 9,3 V level at the output is exceeded. The start of the limiting function is delayed by one line period. This avoids peak white limiting by test patterns which have abrupt transitions from colour to white signals.
- The brightness control is obtained by inserting a variable pulse in the luminance channel. Therefore the ratio of brightness variation and signal amplitude at the three outputs will be identical and independent of the difference in gain of the three channels. Thus discolouring due to adjustment of contrast and brightness is avoided.
- Improved suppression of the internal RGB signals when the device is switched to external signals, and vice versa.
- Non-synchronized external RGB signals do not disturb the black level of the internal signals.
- Improved suppression of the residual 4,4 MHz signal in the RGB output stages.
- Cascoded stages in the demodulators and burst phase detector minimize the radiation of the colour demodulator inputs.
- High current capability of the RGB outputs and the chrominance output.

**QUICK REFERENCE DATA**

|   |                          |       |            |    |
|---|--------------------------|-------|------------|----|
| Supply voltage  | $V_{1-27}$               | type. | 12         | V  |
| Supply current  | $I_1$                    | typ.  | 85         | mA |
| Luminance input signal (peak-to-peak value)                                   | $V_{10-27(p-p)}$         | typ.  | 0,45       | V  |
| Chrominance input signal (peak-to-peak value)                                 | $V_{3-27(p-p)}$          |       | 55 to 1100 | mV |
| Data input signals (peak-to-peak value)                                       | $V_{13, 15, 17-27(p-p)}$ | typ.  | 1          | V  |
| RGB output signals at nominal contrast<br>and saturation (peak-to-peak value) | $V_{12, 14, 16-27(p-p)}$ | typ.  | 5,25       | V  |
| Contrast control range  |                          | typ.  | 20         | dB |
| Saturation control range  |                          | min.  | 50         | dB |
| Input voltage for data insertion  | $V_{9-27}$               | min.  | 0,9        | V  |
| Blanking input voltage  | $V_{8-27}$               | typ.  | 1,5        | V  |
| Burst gating and black-level gating input voltage                             | $V_{8-27}$               | typ.  | 7          | V  |

**PACKAGE OUTLINE**

28-lead DIL; plastic (SOT 117); SOT117-1; 1996 November 21.

PAL decoder

TDA3561A

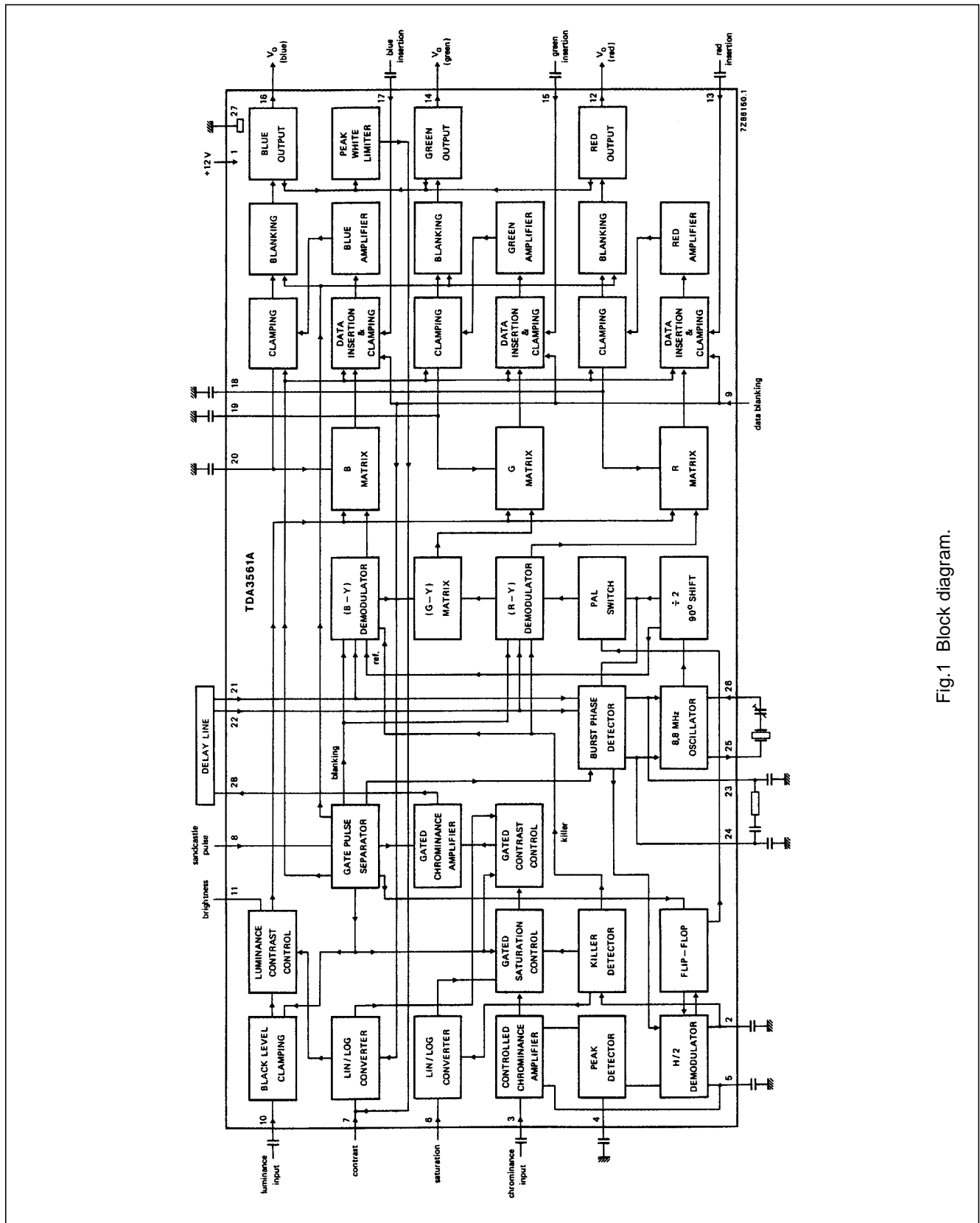

Fig.1 Block diagram.

## PAL decoder

## TDA3561A

**RATINGS**

Limiting values in accordance with the Absolute Maximum System (IEC 134)

|   |                  |      |              |    |
|---|------------------|------|--------------|----|
| Supply voltage                          | $V_P = V_{1-27}$ | max. | 13,2         | V  |
| Total power dissipation; see also Fig.2 | $P_{tot}$        | max. | 1,7          | W  |
| Storage temperature range               | $T_{stg}$        |      | -25 to + 150 | °C |
| Operating ambient temperature range     | $T_{amb}$        |      | -25 to + 65  | °C |

**THERMAL RESISTANCE**

|                          |               |   |    |     |
|--------------------------|---------------|---|----|-----|
| From junction to ambient | $R_{th\ j-a}$ | = | 50 | K/W |
|--------------------------|---------------|---|----|-----|

**CHARACTERISTICS** $V_P = V_{1-27} = 12\text{ V}$ ;  $T_{amb} = 25\text{ °C}$ ; unless otherwise specified

|   |                  |      |            |    |
|---|------------------|------|------------|----|
| Supply voltage  | $V_P = V_{1-27}$ | typ. | 12         | V  |
|   |                  |      | 8 to 13,2  | V  |
| Supply current  |                  | typ. | 85         | mA |
|   |                  | <    | 115        | mA |
| Total power dissipation                                   | $P_{tot}$        | typ. | 1,0        | W  |
|   |                  | <    | 1,4        | W  |
| <b>Luminance input (pin 10)</b>                           |                  |      |            |    |
| Input voltage (peak-to-peak value); note 1                | $V_{10-27(p-p)}$ | typ. | 0,45       | V  |
| Input level before clipping                               | $V_{10-27}$      | <    | 2          | V  |
| Input current; input level 2 V, clamp not active          | $I_{10}$         | typ. | 0,15       | μA |
|   |                  | <    | 1          | μA |
| Contrast control range (see Fig.3)                        |                  |      | -17 to + 3 | dB |
| Control voltage for 40 dB attenuation                     | $V_{7-27}$       | typ. | 1,2        | V  |
| Input current contrast control at $V_{7-27} = 3\text{ V}$ | $I_7$            | <    | 10         | μA |

**Chrominance amplifier**

|   |                   |      |            |    |
|---|-------------------|------|------------|----|
| Input voltage (peak-to-peak value); note 2  | $V_{3-27}\ (p-p)$ | typ. | 550        | mV |
|   |                   |      | 55 to 1100 | mV |
| Input impedance   | $ Z_{3-27} $      | typ. | 9          | kΩ |
|   |                   |      | 6 to 12    | kΩ |
| Input capacitance   | $C_{3-27}$        | typ. | 4          | pF |
|   |                   | <    | 6          | pF |
| A.C.C. control range  |                   | >    | 30         | dB |
| Change of the burst signal at the output<br>over the whole control range                                  |                   | <    | 1,5        | dB |
| Gain at nominal contrast/saturation<br>pin 3 to pin 28; note 3  |                   | >    | 32         | dB |
| Output signal (peak-to-peak value)<br>at nominal contrast/saturation;<br>burst signal: 0,5 V peak to peak | $V_{28-27(p-p)}$  | typ. | 1,7        | V  |

## PAL decoder

## TDA3561A

Maximum output voltage (peak-to-peak value)

|   |                  |      |               |               |
|---|------------------|------|---------------|---------------|
| $R_L = 2 \text{ k}\Omega$   | $V_{28-27(p-p)}$ | typ. | 4,0           | V             |
| Distortion of chrominance amplifier   |                  | typ. | 1,5           | %             |
| at $V_{28-27(p-p)} = 2 \text{ V}$ up to $V_{3-27(p-p)} = 1 \text{ V}$                     | d                | <    | 5             | %             |
| Frequency response between 0 and 5 MHz  |                  |      | -2            | dB            |
| Saturation control range (see Fig.4)  |                  | >    | 50            | dB            |
| Input current saturation control at $V_{6-27} = 3 \text{ V}$                              | $I_6$            | <    | 15            | $\mu\text{A}$ |
| Tracking between luminance and chrominance<br>with contrast control over a range of 10 dB |                  | <    | 2             | dB            |
| Cross-coupling between luminance<br>and chrominance amplifier; note 10                    |                  | <    | -46           | dB            |
| Signal-to-noise ratio<br>at nominal input signal; note 11                                 | S/N              | >    | 56            | dB            |
| Phase shift between burst and chrominance<br>at nominal contrast/saturation               | $\Delta \varphi$ | <    | $\pm 5^\circ$ |               |
| Output impedance of chrominance amplifier   | $ Z_{28-27} $    | typ. | 25            | $\Omega$      |
| Maximum output current  | $I_{28}$         | <    | 15            | mA            |

**Reference part**

Phase locked loop:

|                          |  |      |           |    |
|--------------------------|--|------|-----------|----|
| - catching range; note 4 |  | >    | 500       | Hz |
|                          |  | typ. | 700       | Hz |
| - phase shift; note 5    |  | <    | $5^\circ$ |    |

Oscillator:

|  |                  |      |            |          |
|--|------------------|------|------------|----------|
| - temperature coefficient of oscillator frequency; note 4          |                  | typ. | -1,5       | Hz/K     |
| - frequency deviation for $V_P$ changing from 10 to 13,2 V; note 4 |                  | typ. | 40         | Hz       |
| - input resistance (pin 26)  | $R_{26-27}$      | typ. | 340        | $\Omega$ |
|  |                  |      | 260 to 420 | $\Omega$ |
| - input capacitance (pin 26)                                       | $C_{26-27}$      | <    | 10         | pF       |
| - output resistance (pin 25)                                       | $R_{25-27}$      | typ. | 150        | $\Omega$ |
|  |                  |      | 100 to 200 | $\Omega$ |
| - output voltage (peak-to-peak value; pin 25)                      | $V_{25-27(p-p)}$ | typ. | 700        | mV       |
| A.C.C. generation:   |                  |      |            |          |
| - reference voltage (pin 4)  | $V_{4-27}$       | typ. | 4,9        | V        |
| - control voltage at nominal input signal (pin 2)                  | $V_{2-27}$       | typ. | 5,1        | V        |
| - control voltage without chrominance input (pin 2)                | $V_{2-27}$       | typ. | 2,65       | V        |
| - colour-off voltage (pin 2)                                       | $V_{2-27}$       | typ. | 3,15       | V        |
| - colour-on voltage (pin 2)  | $V_{2-27}$       | typ. | 3,4        | V        |
| - identification-on voltage (pin 2)                                | $V_{2-27}$       | typ. | 1,9        | V        |

## PAL decoder

## TDA3561A

|  |                               |              |                  |            |
|--|-------------------------------|--------------|------------------|------------|
| – change in burst amplitude with supply voltage ( $\pm 10\%$ )   |                               | proportional |                  |            |
| – change in burst amplitude with temperature   |                               | typ.         | 0,1              | %/K        |
|  |                               | <            | 0,25             | %/K        |
| – voltage at pin 5 at nominal input signal   | $V_{5-27}$                    | typ.         | 5                | V          |
| <b>Demodulator part</b>  |                               |              |                  |            |
| Input burst signal amplitude (peak-to-peak value)<br>between pins 21 and 22; note 6  | $V_{21-22(p-p)}$              | typ.         | 100              | mV         |
| Input impedance between pins 21 and 22   | $ Z_{21-22} $                 | typ.         | 2                | k $\Omega$ |
| Ratio of demodulated signals for equal input<br>signals at pins 21 and 22<br>(B-Y)/(R-Y)   | $\frac{V_{16-27}}{V_{12-27}}$ | typ.         | $1,78 \pm 10\%$  |            |
| (G-Y)/(R-Y); no (B-Y) signal   | $\frac{V_{14-27}}{V_{12-27}}$ | typ.         | $-0,51 \pm 10\%$ |            |
| (G-Y)/(B-Y); no (R-Y) signal   | $\frac{V_{14-27}}{V_{16-27}}$ | typ.         | $-0,19 \pm 25\%$ |            |
| Frequency response between 0 and 1 MHz   |                               |              | -3               | dB         |
| Cross talk between colour demodulated signals  |                               | >            | 40               | dB         |
| Phase difference between (R-Y) signal<br>and (R-Y) reference signal  |                               | <            | 5°               |            |
| Phase difference between (R-Y)<br>and (B-Y) reference signals  |                               | typ.         | 90°<br>85 to 95° |            |
| <b>R.G.B. matrix and amplifiers</b>  |                               |              |                  |            |
| Output voltage (peak-to-peak value)<br>at nominal luminance/contrast<br>(black to white); note 3   | $V_{12,14,16-27(p-p)}$        | typ.         | 5,4              | V          |
|  |                               |              | 4,5 to 6,3       | V          |
| Output voltage (peak-to-peak value) of the RED<br>channel at nominal contrast/saturation and<br>no luminance signal at the input, (R-Y) signal | $V_{12-27(p-p)}$              | typ.         | 5,25             | V          |
|  |                               |              | 3,7 to 6,7       | V          |
| Maximum peak white level; note 7   |                               | typ.         | 9,3              | V          |
|  |                               |              | 9,0 to 9,6       | V          |
| Maximum output current   | $I_{12,14,16}$                | <            | 15               | mA         |
| Black level at the output for a<br>brightness control voltage of 2 V   | $V_{12,14,16-27}$             | typ.         | 2,6              | V          |
| Difference in black level between the three<br>channels at an output level of 3 V; note 8  | $\Delta V$                    | <            | 200              | mV         |
| Black level shift with vision contents   |                               | <            | 40               | mV         |
| Brightness control voltage range   | see Fig.5                     |              |                  |            |

## PAL decoder

## TDA3561A

|   |  |      |             |               |
|---|--|------|-------------|---------------|
| Input current brightness control  | $I_{11}$   | <    | 50          | $\mu\text{A}$ |
| Variation of black level with temperature   | $\Delta V$   | typ. | 0,35        | mV/K          |
|   |  | <    | 1,0         | mV/K          |
| Variation of black level with contrast control  | $\Delta V$   | typ. | 10          | mV            |
|   |  | <    | 200         | mV            |
| Relative spread between the R, G and B output signals   |  | <    | 10          | %             |
| Relative black-level variation between the three channels during variation of contrast and supply voltage |  | typ. | 0           | mV            |
|   |  | <    | 20          | mV            |
| Differential black-level drift over a temperature range of 40 °C  |  | typ. | 0           | mV            |
|   |  | <    | 20          | mV            |
| Blanking level at the RGB outputs   |  | typ. | 2,1         | V             |
|   |  |      | 1,9 to 2,3  | V             |
| Difference in blanking level of the three channels  |  | typ. | 0           | mV            |
| Differential blanking level drift over a temperature range of 40 °C                                       |  | typ. | 0           | mV            |
| Tracking of output black level with supply voltage  | $\frac{\Delta V_{bl}}{V_{bl}} \times \frac{V_P}{\Delta V_P}$ | typ. | 1,1         |               |
| Signal-to-noise ratio of output signals; note 11  | S/N  | >    | 62          | dB            |
| Residual 4,4 MHz signal at RGB outputs (peak-to-peak value)   |  | typ. | 40          | mV            |
|   |  | <    | 150         | mV            |
| Residual 8,8 MHz signal and higher harmonics at the RGB outputs (peak-to-peak value)                      |  | typ. | 75          | mV            |
|   |  | <    | 150         | mV            |
| Output impedance of RGB outputs   | $ Z_{12,14,16-27} $  | typ. | 50          | $\Omega$      |
| Frequency response of total luminance and RGB amplifier circuits for $f = 0$ to 5 MHz                     |  | <    | -3          | dB            |
| <b>Signal insertion</b> (pins 13,15 and 17)   |  |      |             |               |
| Input signals (peak-to-peak value) for an RGB output voltage of 5 V peak-to-peak                          | $V_{13,15,17-27(p-p)}$                                       | typ. | 1           | V             |
|   |  |      | 0,85 to 1,1 | V             |
| Difference between the black levels of the RGB signals and the inserted signals at the output; note 9     | $\Delta V$   | <    | 260         | mV            |
| Output rise time  | $t_r$  | typ. | 40          | ns            |
|   |  | <    | 80          | ns            |
| Differential delay time for the three channels  | $t_d$  | typ. | 0           | ns            |
|   |  | <    | 40          | ns            |
| Input current   | $I_{13,15,17}$   | <    | 10          | $\mu\text{A}$ |

## PAL decoder

## TDA3561A

**Data blanking** (pin 9)

|   |              |      |     |               |
|---|--------------|------|-----|---------------|
| Input voltage for no data insertion                                       | $V_{9-27}$   | <    | 0,4 | V             |
| Input voltage for data insertion  | $V_{9-27}$   | >    | 0,9 | V             |
| Maximum input voltage   | $V_{9-27}$   | <    | 3   | V             |
| Delay of data blanking  | $t_d$        | <    | 20  | ns            |
| Input current   | $I_9$        | <    | 35  | $\mu\text{A}$ |
| Input impedance   | $ Z_{9-27} $ | typ. | 10  | k $\Omega$    |
| Suppression of the internal RGB signals<br>when $V_{9-27} > 0,9\text{ V}$ |              | >    | 46  | dB            |

**Sandcastle input** (pin 8)

|   |            |      |                    |               |
|---|------------|------|--------------------|---------------|
| Level at which the RGB blanking<br>is activated                 | $V_{8-27}$ | typ. | 1,5<br>1 to 2      | V<br>V        |
| Level at which burst gating and<br>clamping pulse are separated | $V_{8-27}$ | typ. | 7,0<br>6, 5 to 7,5 | V<br>V        |
| Delay between black level clamping and<br>burst gating pulse    | $t_d$      | typ. | 0,4                | $\mu\text{s}$ |
| Input current for:  |            |      |                    |               |
| $V_{8-27} = 0\text{ to }1\text{ V}$                             | $-I_8$     | <    | 1                  | mA            |
| $V_{8-27} = 1\text{ to }8,5\text{ V}$                           | $I_8$      | typ. | 20                 | $\mu\text{A}$ |
| $V_{8-27} = 8,5\text{ to }12\text{ V}$                          | $I_8$      | <    | 2                  | mA            |

**Notes to the characteristics**

- Signal with the negative-going sync; amplitude includes sync pulse amplitude.
- Indicated is a signal for a colour bar with 75% saturation, so chrominance to burst ratio is 2,2 : 1.
- Nominal contrast is specified as the maximum contrast  $-3\text{ dB}$  and nominal saturation as the maximum saturation  $-6\text{ dB}$ .
- All frequency variations are referred to the 4,4 MHz carrier frequency.
- For  $\pm 400\text{ Hz}$  deviation of the oscillator frequency.
- These signal amplitudes are determined by the a.c.c. circuit of the reference part.
- When this level is exceeded, the amplitude of the output signal is reduced via a discharge of the capacitor at pin 7 (contrast control). The start of the peak white limiting action has a delay of one line period.
- The variation of the black level depends directly on the gain of each channel during brightness control in the three channels. As a consequence, the black levels at the outputs (for output levels above or below 3 V) can have a difference which exceeds 200 mV. Because the amplitude and the black level change with brightness control have a direct relationship, no discolouring can occur, caused by adjustment of contrast and brightness.
- This difference occurs when the source impedance of the data signal inputs is 150  $\Omega$  and the black level clamp pulse duration is 4  $\mu\text{s}$  (sandcastle pulse). A lower difference is obtained when the impedance is lower.
- Cross-coupling is measured under the following condition. Input signals nominal, contrast and saturation such that nominal output signals are obtained. The signals at the output at which no signal should be available must be compared with the nominal output signal at that output.
- The signal-to-noise ratio is specified as peak-to-peak signal with respect to r.m.s. noise.



PAL decoder

TDA3561A

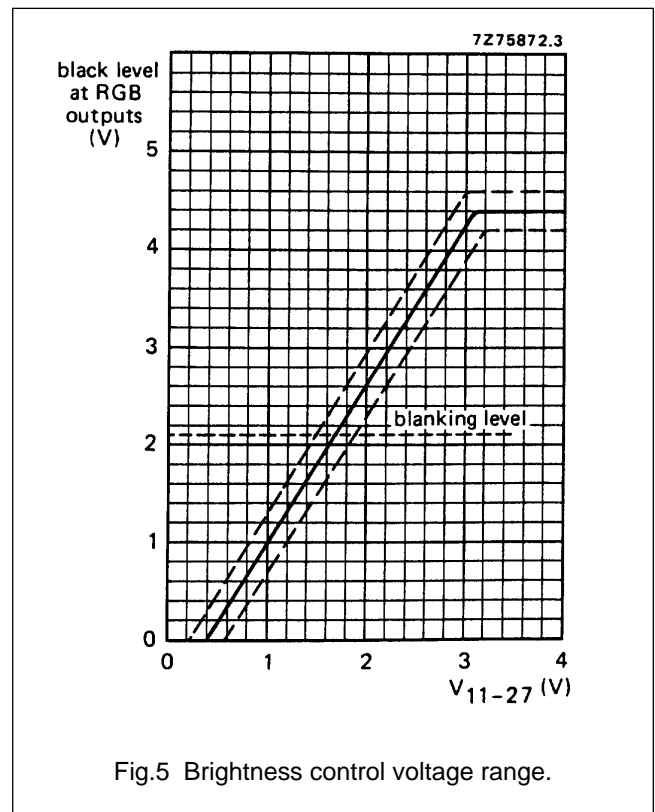
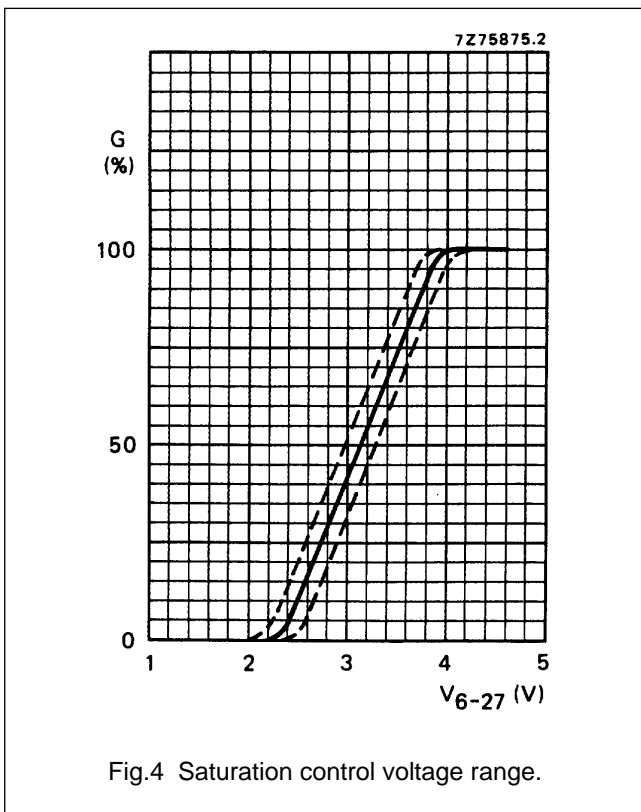
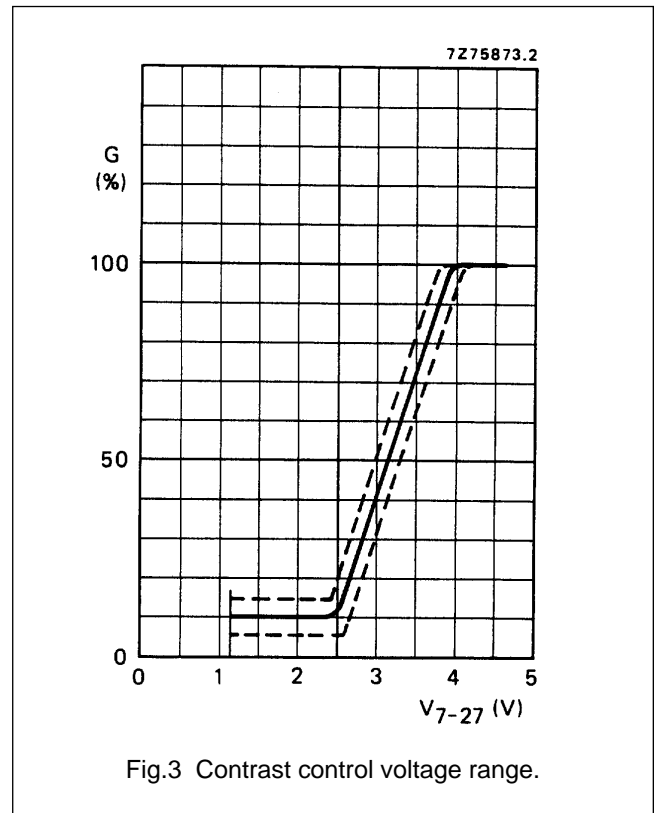
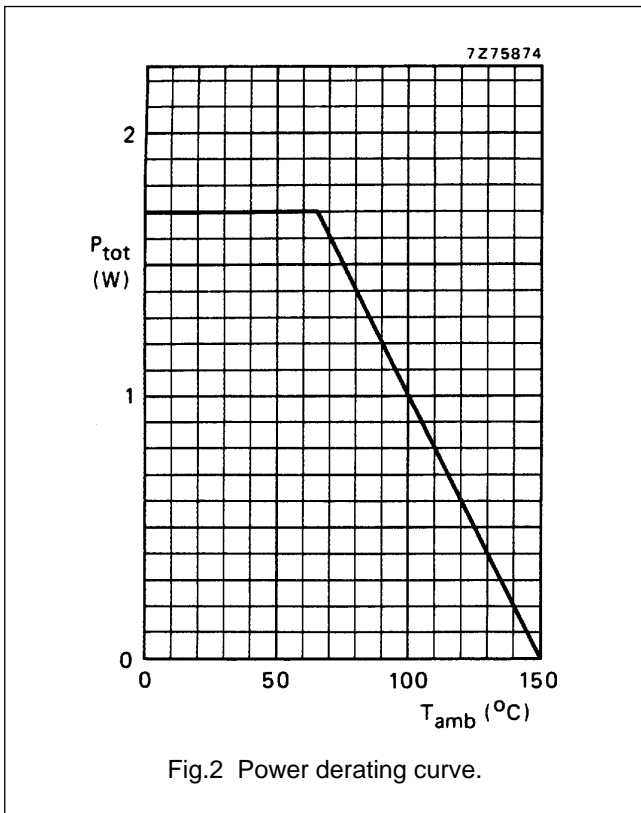

PAL decoder

TDA3561A

APPLICATION INFORMATION

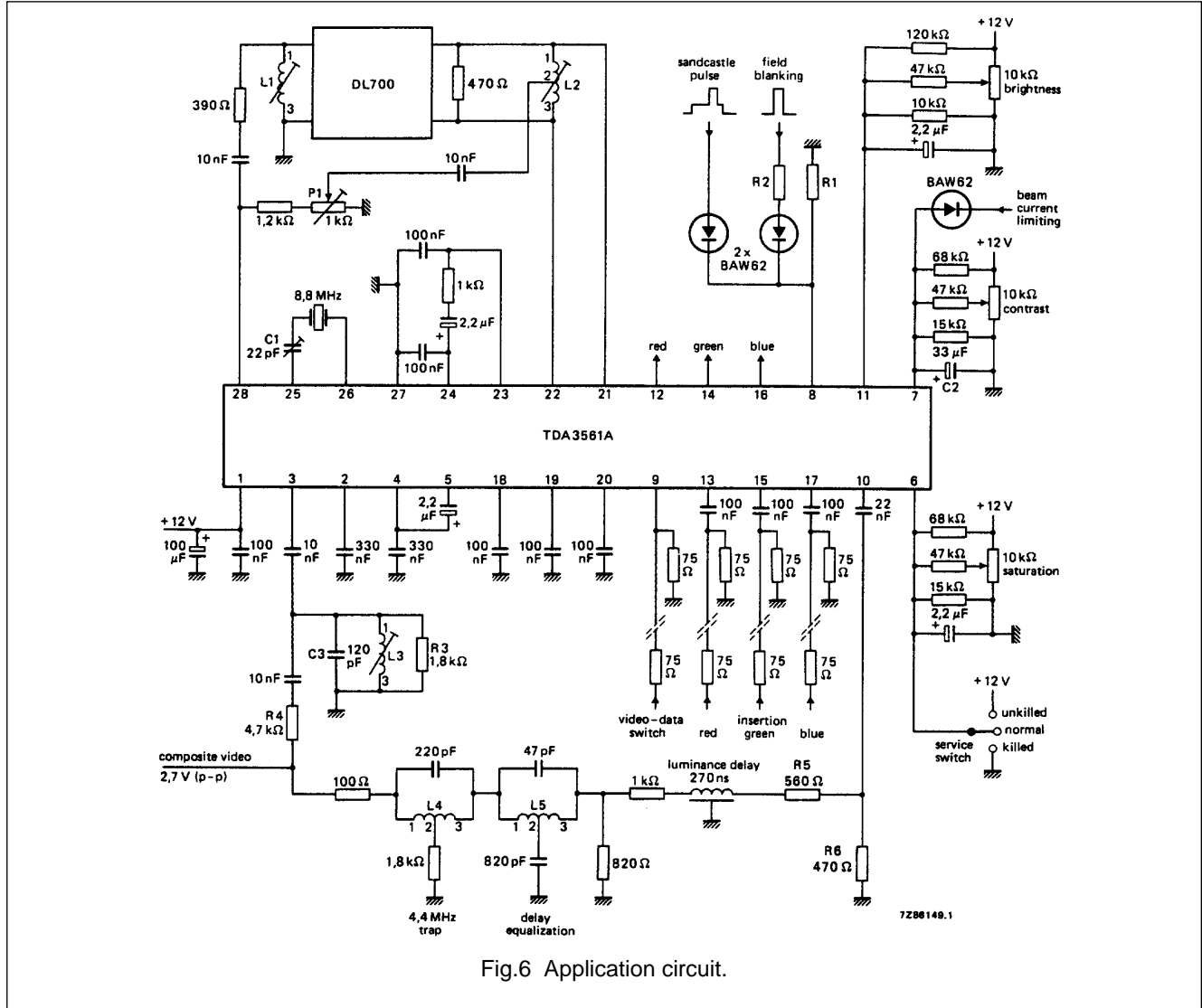

Fig.6 Application circuit.

Adjustments (see Fig.6)

- C1 8,8 MHz oscillator
- L1 phase delay line = 10,7 μH
- L2 nominal value = 10,7 μH
- L3 4,4 MHz chrominance input filter = 10,7 μH = L1
- L4 4,4 MHz trap in luminance signal line = 5,6 μH
- L5 delay equalization = 66,1 μH
- P1 amplitude of direct chroma signal
- R1 field blanking  $\frac{R1}{R1 + R2} \times \text{field blanking amplitude } 2,0 \text{ V to } 6,5 \text{ V.}$
- R2

For a video input voltage of 1 V peak-to-peak: R3 can be omitted; R4 = 1 kΩ; R5 must be short-circuited; R6 = 1 kΩ.

## PAL decoder

## TDA3561A

**APPLICATION INFORMATION**

The function is described against the corresponding pin number.

**1. + 12 V power supply**

The circuit gives good operation in a supply voltage range between 8 and 13,2 V provided that the supply voltage for the controls is equal to the supply voltage for the TDA3561A. All signal and control levels have a linear dependency on the supply voltage. The current taken by the device at 12 V is typically 85 mA. It is linearly dependent on the supply voltage.

**2. Control voltage for identification**

This pin requires a detection capacitor of about 330 nF for correct operation. The voltages available under various signal conditions are given in the specification.

**3. Chrominance input**

The chroma signal must be a.c.-coupled to the input. Its amplitude must be between 55 mV and 1100 mV peak-to-peak (25 mV to 500 mV peak-to-peak burst signal). All figures for the chroma signals are based on a colour bar signal with 75% saturation, that is the burst-to-chroma ratio of the input signal is 1 : 2,25.

**4. Reference voltage A.C.C. detector**

This pin must be decoupled by a capacitor of about 330 nF. The voltage at this pin is 4,9 V.

**5. Control voltage A.C.C.**

The A.C.C. is obtained by synchronous detection of the burst signal followed by a peak detector. A good noise immunity is obtained in this way and an increase of the colour for weak input signals is prevented. The recommended capacitor value at this pin is 2,2  $\mu$ F.

**6. Saturation control**

The saturation control range is in excess of 50 dB. The control voltage range is 2 to 4 V. Saturation control is a linear function of the control voltage.

When the colour killer is active, the saturation control voltage is reduced to a low level if the resistance of the external saturation control network is sufficiently high. Then the chroma amplifier supplies no signal to the demodulator. Colour switch-on can be delayed by proper choice of the time constant for the saturation control setting circuit.

When the saturation control pin is connected to the power supply the colour killer circuit is overruled so that the colour signal is visible on the screen. In this way it is possible to adjust the oscillator frequency without using a frequency counter (see also pins 25 and 26).

**7. Contrast control**

The contrast control range is 20 dB for a control voltage change from + 2 to + 4 V. Contrast control is a linear function of the control voltage. The output signal is suppressed when the control voltage is 1 V or less. If one or more output signals surpasses the level of 9 V the peak white limiter circuit becomes active and reduces the output signals via the contrast control by discharging C2 via an internal current sink.

**8. Sandcastle and field blanking input**

The output signals are blanked if the amplitude of the input pulse is between 2 and 6,5 V. The burst gate and clamping circuits are activated if the input pulse exceeds a level of 7,5 V.

The higher part of the sandcastle pulse should start just after the sync pulse to prevent clamping of video signal on the sync pulse. The width should be about 4  $\mu$ s for proper A.C.C. operation.

**9. Video-data switching**

The insertion circuit is activated by means of this input by an input pulse between 1 V and 2 V. In that condition, the internal RGB signals are switched off and the inserted signals are supplied to the output amplifiers. If only normal operation is wanted this pin should be connected to the negative supply. The switching times are very short (< 20 ns) to avoid coloured edges of the inserted signals on the screen.

**10. Luminance signal input**

The input signal should have a peak-to-peak amplitude of 0,45 V (peak white to sync) to obtain a black-white output signal to 5 V at nominal contrast. It must be a.c.-coupled to the input by a capacitor of about 22 nF. The signal is clamped at the input to an internal reference voltage. A 1 k $\Omega$  luminance delay line can be applied because the luminance input impedance is made very high. Consequently the charging and discharging currents of the coupling capacitor are very small and do not influence the signal level at the input noticeably. Additionally the coupling capacitor value may be small.

---

**PAL decoder****TDA3561A**

---

**11. Brightness control**

The black level of the RGB outputs can be set by the voltage on this pin (see Fig.5). The black level can be set higher than 4 V however the available output signal amplitude is reduced (see pin 7). Brightness control also operates on the black level of the inserted signals.

**12, 14, 16. RGB outputs**

The output circuits for red, green and blue are identical. Output signals are 5,25 V (R, G and B) at nominal input signals and control settings. The black levels of the three outputs have the same value. The blanking level at the outputs is 2,1 V. The peak white level is limited to 9,3 V. When this level exceeded the output signal amplitude is reduced via the contrast control (see pin 7).

**13, 15, 17. Inputs for external RGB signals**

The external signals must be a.c.-coupled to the inputs via a coupling capacitor of about 100 nF. Source impedance should not exceed 150  $\Omega$ . The input signal required for a 5 V peak-to-peak output signal is 1 V peak-to-peak. At the RGB outputs the black level of the inserted signal is identical to that of normal RGB signals. When these inputs are not used the coupling capacitors have to be connected to the negative supply.

**18, 19, 20. Black level clamp capacitors**

The black level clamp capacitors for the three channels are connected to these pins. The value of each capacitor should be about 100 nF.

**21, 22. Inputs (B-Y) and (R-Y) demodulators**

The input signal is automatically fixed to the required level by means of the burst phase detector and A.C.C. generator which are connected to pin 21 and pin 22. As the burst (applied differentially to those pins) is kept constant by the A.C.C., the colour difference signals automatically have the correct value.

**23, 24. Burst phase detector outputs**

At these pins the output of the burst phase detector is filtered and controls the reference oscillator. An adequate catching range is obtained with the time constants given in the application circuit (see Fig.6).

**25, 26. Reference oscillator**

The frequency of the oscillator is adjusted by the variable capacitor C1. For frequency adjustment interconnect pin 21 and pin 22. The frequency can be measured by connecting a suitable frequency counter to pin 25.

**28. Output of the chroma amplifier**

Both burst and chroma signals are available at the output. The burst-to-chroma ratio at the output is identical to that at the input for nominal control settings. The burst signal is not affected by the controls. The amplitude of the input signal to the demodulator is kept constant by the A.C.C. Therefore the output signal at pin 28 will depend on the signal loss in the delay line.

PAL decoder

TDA3561A

PACKAGE OUTLINE

DIP28: plastic dual in-line package; 28 leads (600 mil)

SOT117-1

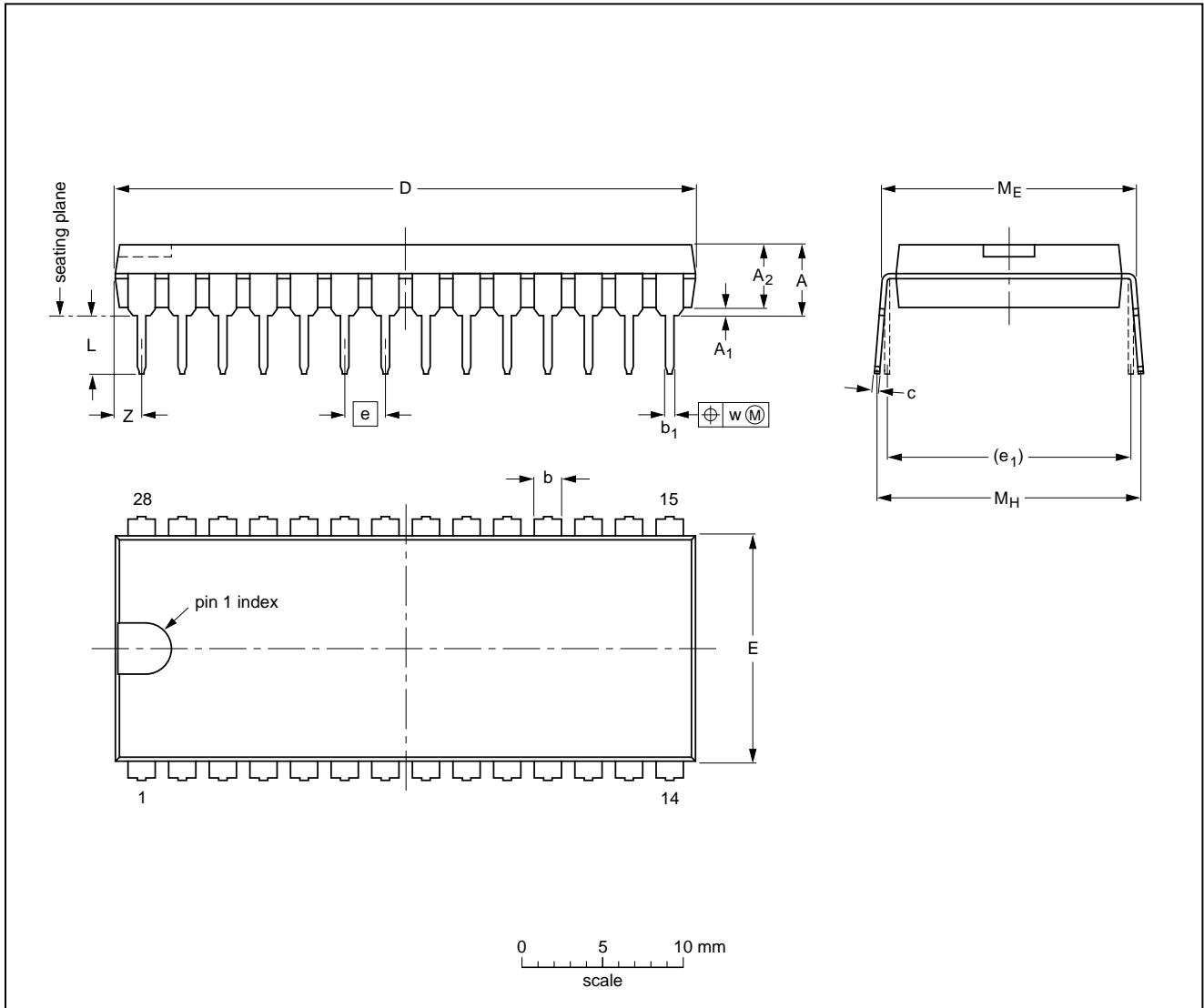

DIMENSIONS (inch dimensions are derived from the original mm dimensions)

| UNIT   | A max. | A <sub>1</sub> min. | A <sub>2</sub> max. | b              | b <sub>1</sub> | c              | D <sup>(1)</sup> | E <sup>(1)</sup> | e    | e <sub>1</sub> | L            | M <sub>E</sub> | M <sub>H</sub> | w    | Z <sup>(1)</sup> max. |
|--------|--------|---------------------|---------------------|----------------|----------------|----------------|------------------|------------------|------|----------------|--------------|----------------|----------------|------|-----------------------|
| mm     | 5.1    | 0.51                | 4.0                 | 1.7<br>1.3     | 0.53<br>0.38   | 0.32<br>0.23   | 36.0<br>35.0     | 14.1<br>13.7     | 2.54 | 15.24          | 3.9<br>3.4   | 15.80<br>15.24 | 17.15<br>15.90 | 0.25 | 1.7                   |
| inches | 0.20   | 0.020               | 0.16                | 0.066<br>0.051 | 0.020<br>0.014 | 0.013<br>0.009 | 1.41<br>1.34     | 0.56<br>0.54     | 0.10 | 0.60           | 0.15<br>0.13 | 0.62<br>0.60   | 0.68<br>0.63   | 0.01 | 0.067                 |

Note

1. Plastic or metal protrusions of 0.25 mm maximum per side are not included.

| OUTLINE VERSION | REFERENCES |          |      |  | EUROPEAN PROJECTION | ISSUE DATE           |
|-----------------|------------|----------|------|--|---------------------|----------------------|
|                 | IEC        | JEDEC    | EIAJ |  |                     |                      |
| SOT117-1        | 051G05     | MO-015AH |      |  |                     | 92-11-17<br>95-01-14 |

## PAL decoder

## TDA3561A

**SOLDERING****Introduction**

There is no soldering method that is ideal for all IC packages. Wave soldering is often preferred when through-hole and surface mounted components are mixed on one printed-circuit board. However, wave soldering is not always suitable for surface mounted ICs, or for printed-circuits with high population densities. In these situations reflow soldering is often used.

This text gives a very brief insight to a complex technology. A more in-depth account of soldering ICs can be found in our "IC Package Databook" (order code 9398 652 90011).

**Soldering by dipping or by wave**

The maximum permissible temperature of the solder is 260 °C; solder at this temperature must not be in contact with the joint for more than 5 seconds. The total contact time of successive solder waves must not exceed 5 seconds.

The device may be mounted up to the seating plane, but the temperature of the plastic body must not exceed the specified maximum storage temperature ( $T_{stg\ max}$ ). If the printed-circuit board has been pre-heated, forced cooling may be necessary immediately after soldering to keep the temperature within the permissible limit.

**Repairing soldered joints**

Apply a low voltage soldering iron (less than 24 V) to the lead(s) of the package, below the seating plane or not more than 2 mm above it. If the temperature of the soldering iron bit is less than 300 °C it may remain in contact for up to 10 seconds. If the bit temperature is between 300 and 400 °C, contact may be up to 5 seconds.

**DEFINITIONS**

| <b>Data sheet status</b>  |   |
|---|---|
| Objective specification   | This data sheet contains target or goal specifications for product development.       |
| Preliminary specification   | This data sheet contains preliminary data; supplementary data may be published later. |
| Product specification   | This data sheet contains final product specifications.                                |
| <b>Limiting values</b>  |   |
| Limiting values given are in accordance with the Absolute Maximum Rating System (IEC 134). Stress above one or more of the limiting values may cause permanent damage to the device. These are stress ratings only and operation of the device at these or at any other conditions above those given in the Characteristics sections of the specification is not implied. Exposure to limiting values for extended periods may affect device reliability. |   |
| <b>Application information</b>  |   |
| Where application information is given, it is advisory and does not form part of the specification.   |   |

**LIFE SUPPORT APPLICATIONS**

These products are not designed for use in life support appliances, devices, or systems where malfunction of these products can reasonably be expected to result in personal injury. Philips customers using or selling these products for use in such applications do so at their own risk and agree to fully indemnify Philips for any damages resulting from such improper use or sale.