

DATA SHEET

BLW898 UHF linear power transistor

Product specification
Supersedes data of 1995 Oct 04

1996 Jul 16

UHF linear power transistor

BLW898

FEATURES

- Internal input matching for wideband operation and high power gain
- Polysilicon emitter ballasting resistors for an optimum temperature profile
- Gold metallization ensures excellent reliability.

APPLICATION

- Common emitter class-A operation in linear transposers/transmitters (television) in the 470 to 860 MHz frequency band.

DESCRIPTION

NPN silicon planar transistor in a SOT171A 6-lead rectangular flange package, with a ceramic cap. The transistor delivers a $P_{o\ sync} = 3\text{ W}$ in class-A operation at 860 MHz and a supply voltage of 25 V.

PINNING SOT171A

PIN	DESCRIPTION
1	emitter
2	emitter
3	base
4	collector
5	emitter
6	emitter

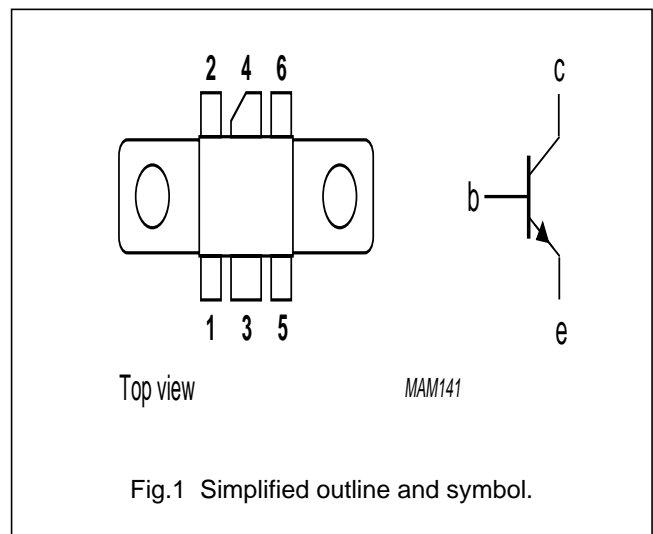

QUICK REFERENCE DATA

RF performance at $T_h = 25\text{ °C}$ in a common emitter test circuit.

MODE OF OPERATION	f (MHz)	V_{CE} (V)	I_{CQ} (A)	$P_{o\ sync}$ (W)	G_p (dB)
CW class-A	860	25	1.1	$\geq 3^{(1)}$	$\geq 9^{(1)}$

Note

1. Three-tone test signal (-8, -16, and -10 dB); $d_{im} = -63\text{ dB}$.

WARNING
Product and environmental safety - toxic materials
This product contains beryllium oxide. The product is entirely safe provided that the BeO disc is not damaged. All persons who handle, use or dispose of this product should be aware of its nature and of the necessary safety precautions. After use, dispose of as chemical or special waste according to the regulations applying at the location of the user. It must never be thrown out with the general or domestic waste.

UHF linear power transistor

BLW898

LIMITING VALUES

In accordance with the Absolute Maximum Rating System (IEC 134).

SYMBOL	PARAMETER	CONDITIONS	MIN.	MAX.	UNIT
V_{CBO}	collector-base voltage	open emitter	–	60	V
V_{CEO}	collector-emitter voltage	open base	–	28	V
V_{EBO}	emitter-base voltage	open collector	–	2.5	V
I_C	collector current (DC)		–	3.7	A
$I_{C(AV)}$	average collector current		–	3.7	A
P_{tot}	total power dissipation	up to $T_{mb} = 70\text{ °C}$	–	44	W
T_{stg}	storage temperature		–65	+150	°C
T_j	operating junction temperature		–	200	°C

THERMAL CHARACTERISTICS

SYMBOL	PARAMETER	CONDITIONS	VALUE	UNIT
$R_{th\ j-mb}$	thermal resistance from junction to mounting-base	$P_{tot} = 44\text{ W}; T_{mb} = 70\text{ °C}$	3	K/W
$R_{th\ mb-h}$	thermal resistance from mounting-base to heatsink		0.3	K/W

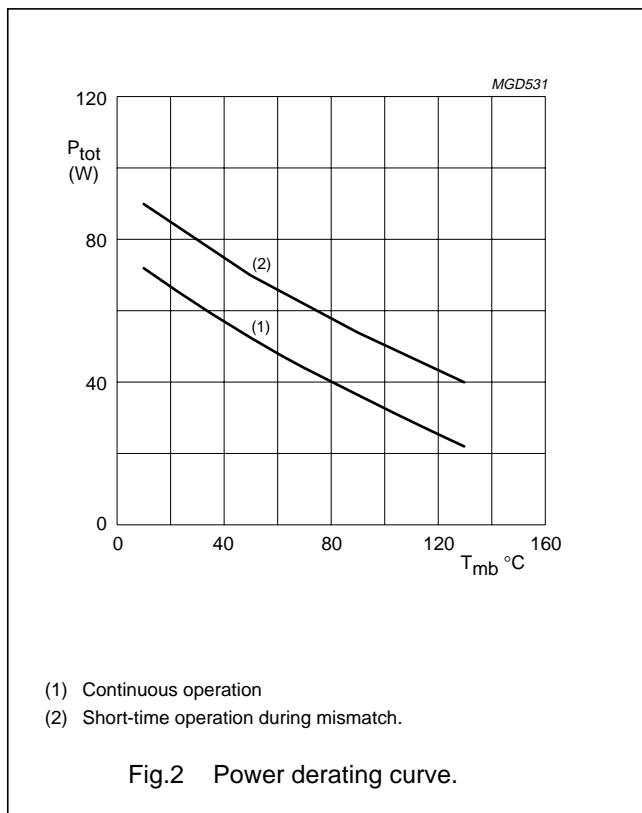

UHF linear power transistor

BLW898

CHARACTERISTICS

$T_j = 25\text{ }^\circ\text{C}$ unless otherwise specified.

SYMBOL	PARAMETER	CONDITIONS	MIN.	TYP.	MAX.	UNIT
$V_{(BR)CBO}$	collector-base breakdown voltage	$I_C = 15\text{ mA}; I_E = 0$	60	–	–	V
$V_{(BR)CEO}$	collector-emitter breakdown voltage	$I_C = 30\text{ mA}; I_B = 0$	28	–	–	V
$V_{(BR)EBO}$	emitter-base breakdown voltage	$I_E = 0.6\text{ mA}; I_C = 0$	2.5	–	–	V
I_{CBO}	collector-base leakage current	$V_{BE} = 0; V_{CB} = 28\text{ V}$	–	–	1.5	mA
I_{CEO}	collector-emitter leakage current	$V_{CE} = 20\text{ V}$	–	–	3	mA
h_{FE}	DC current gain	$V_{CE} = 25\text{ V}; I_C = 1.1\text{ A}$	30	–	140	
C_c	collector capacitance	$V_{CB} = 25\text{ V}; I_E = i_e = 0;$ $f = 1\text{ MHz}$	–	18	–	pF
C_{re}	feedback capacitance	$V_{CB} = 25\text{ V}; I_C = 0; f = 1\text{ MHz}$	–	11	–	pF

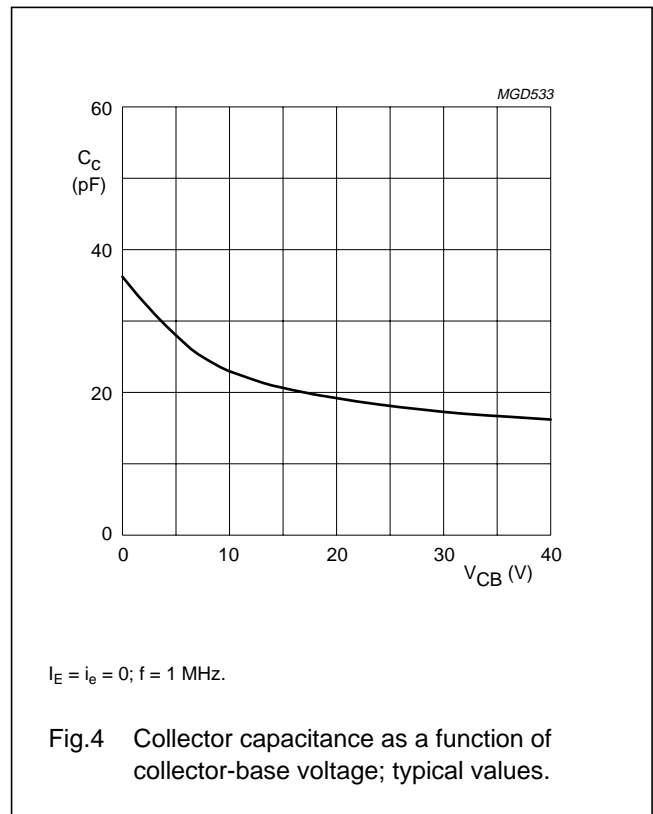
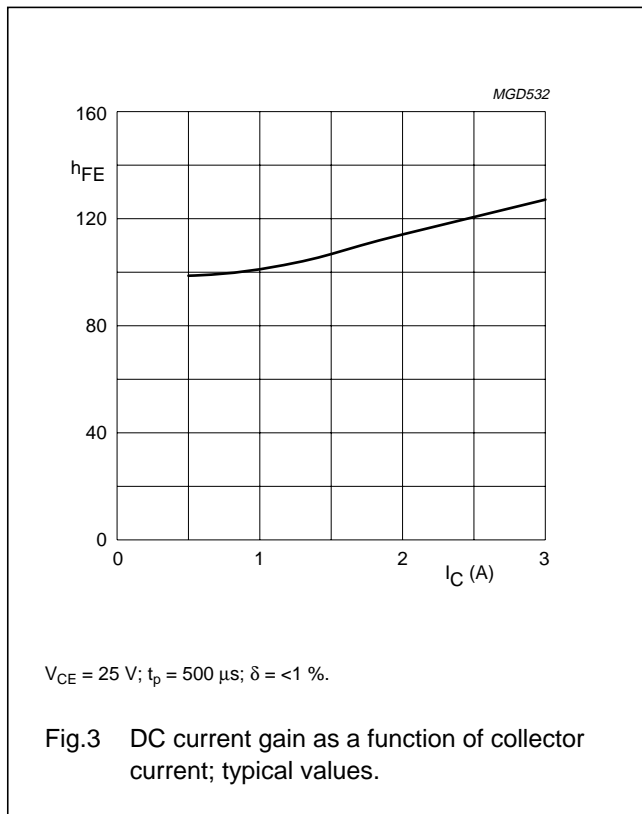

UHF linear power transistor

BLW898

APPLICATION INFORMATION

RF performance at $T_h = 25\text{ }^\circ\text{C}$ in a common emitter class-A test circuit.

MODE OF OPERATION	f (MHz)	V _{CE} (V)	I _{CQ} (A)	P _{O sync} (W)	G _p (dB)	d _{im} (dB)
CW class-A	860	25	1.1	≥3 ⁽¹⁾	≥9 ⁽¹⁾	<-63 ⁽¹⁾
CW class-A	860	25	1.1	≥3 ⁽²⁾	≥9 ⁽²⁾	<-60 ⁽²⁾

Notes

- Three-tone test method (vision carrier -8 dB, sound carrier -10 dB, sideband signal -16 dB), 0 dB corresponds to peak sync level.
- Three-tone test method (vision carrier -8 dB, sound carrier -7 dB, sideband signal -16 dB), 0 dB corresponds to peak sync level.

Ruggedness in class-A operation

The BLW898 is capable of withstanding a load mismatch corresponding to VSWR = 50 : 1 through all phases, under the conditions: V_{CE} = 25 V; I_{CQ} = 1.1 A; T_h = 25 °C; f = 860 MHz; P_{O sync} = 3 W.

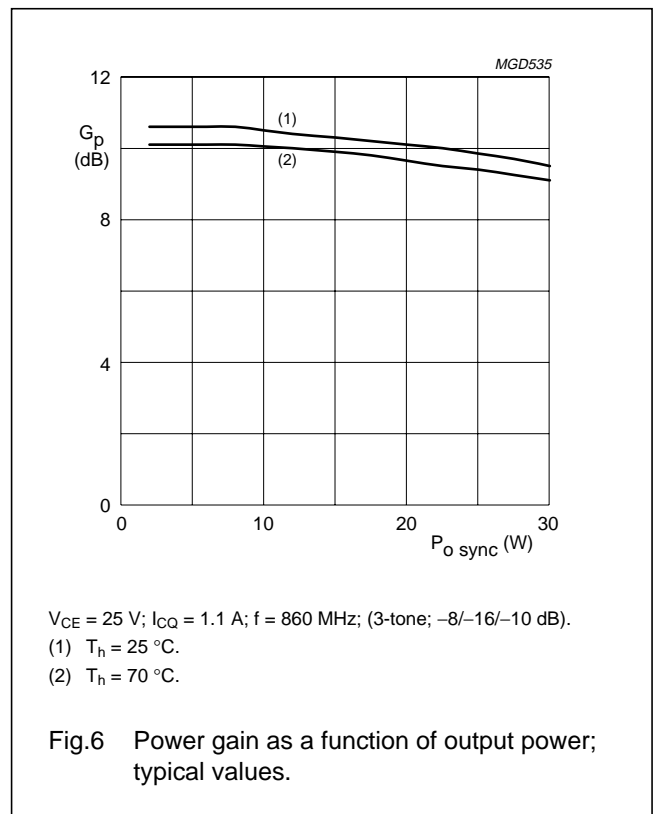
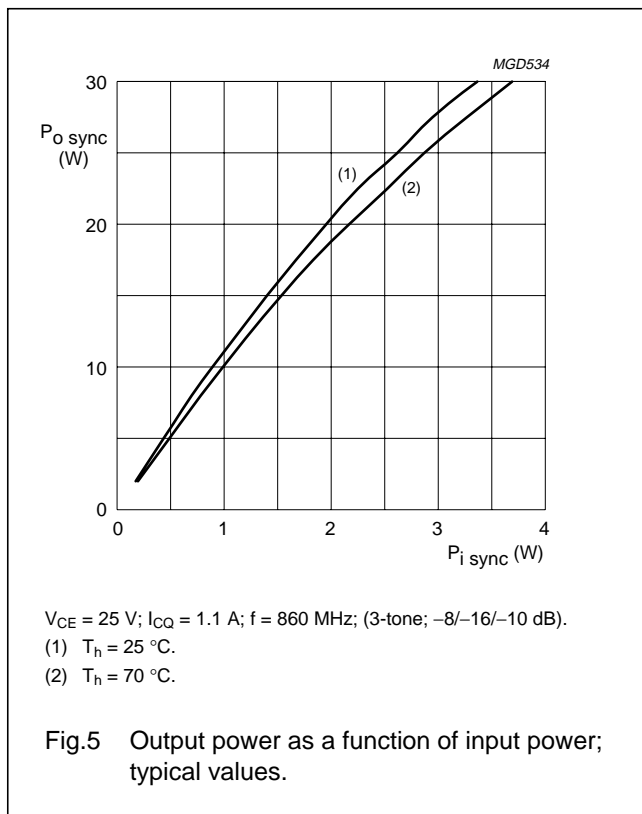

UHF linear power transistor

BLW898

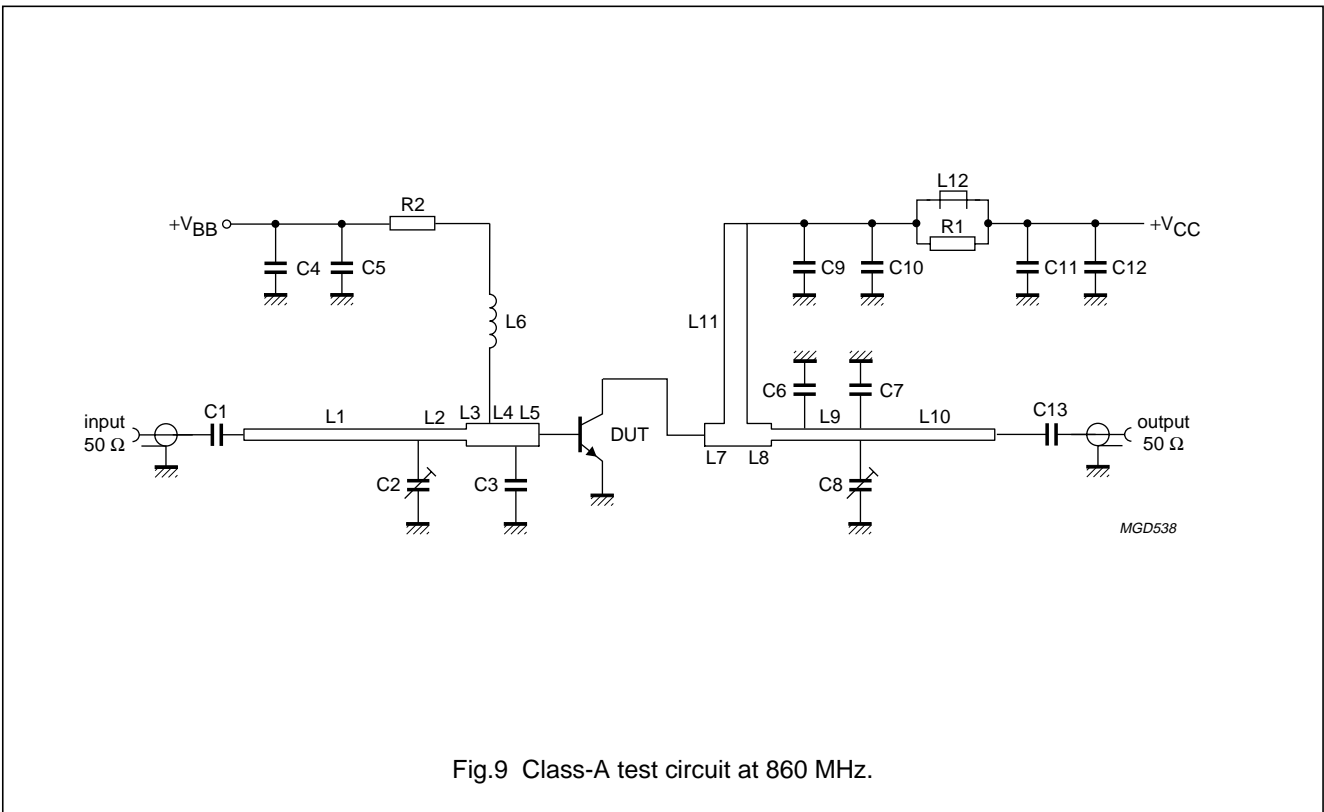
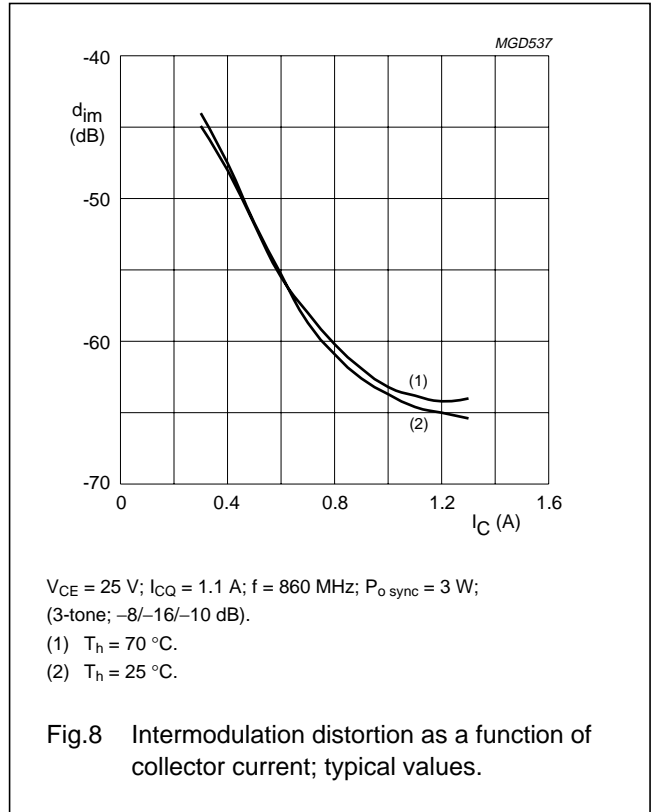
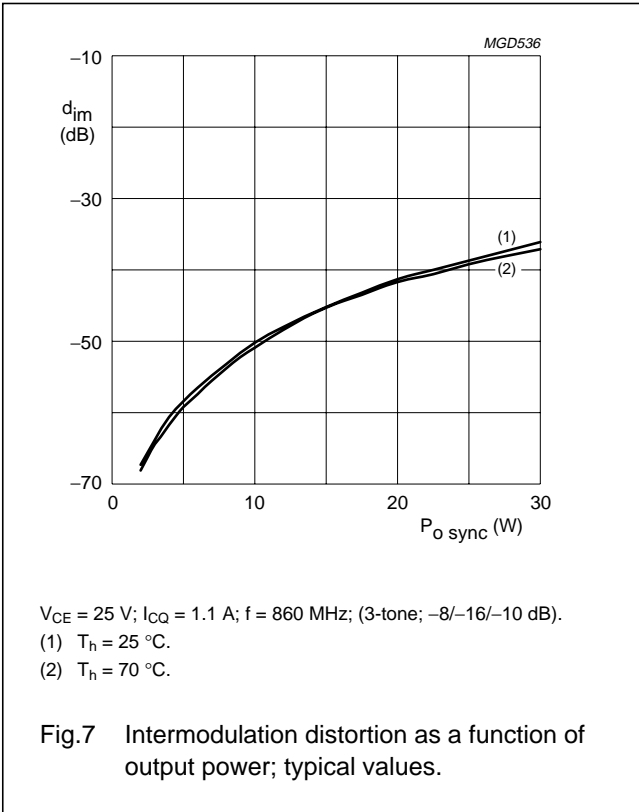

UHF linear power transistor

BLW898

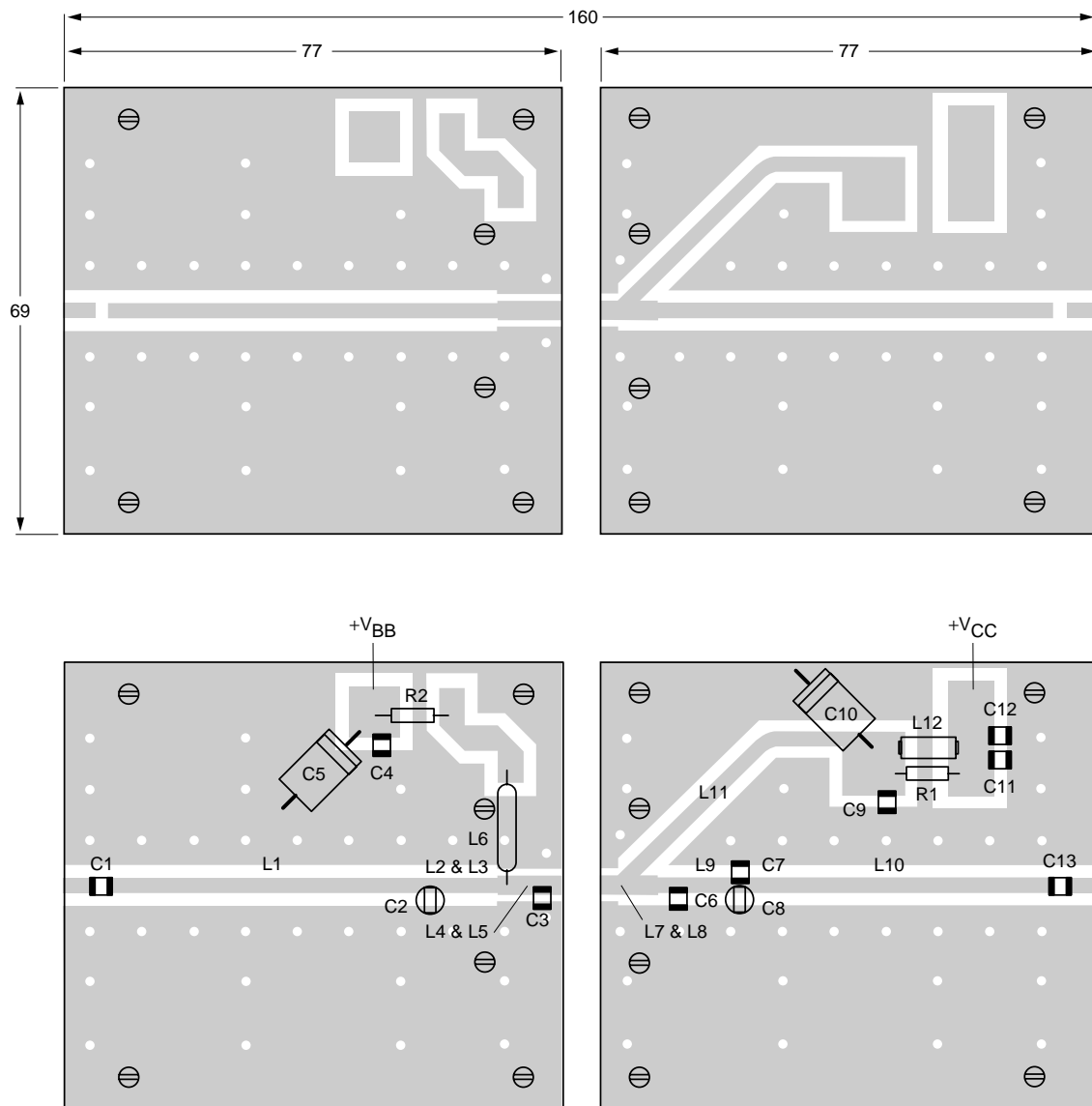

MGD539

Dimensions in mm.

Fig.10 Printed-circuit board and component lay-out for 860 MHz class-A test circuit.

UHF linear power transistor

BLW898

List of components

COMPONENT	DESCRIPTION	VALUE	DIMENSIONS	CATALOGUE No.
C1	multilayer ceramic chip capacitor; note 1	8.2 pF		
C2, C8	Tekelec Giga trim 37271	0.6 to 4.5 pF		
C3	multilayer ceramic chip capacitor; note 1	15 pF		
C4, C12	multilayer ceramic chip capacitor	10 nF; 63 V		2222 592 16627
C5	solid aluminium capacitor	10 μ F; 63 V		2222 030 38109
C6	multilayer ceramic chip capacitor; note 2	10 pF		
C7	multilayer ceramic chip capacitor; note 2	2.4 pF		
C9	multilayer ceramic chip capacitor; note 2	500 pF		
C10	solid aluminium capacitor	47 μ F; 63 V		2222 031 38479
C11	multilayer ceramic chip capacitor; note 2	330 pF		
C13	multilayer ceramic chip capacitor; note 1	5.1 pF		
L1	stripline; note 3	50 Ω	50 \times 2.3 mm	
L2	stripline; note 3	50 Ω	10 \times 2.3 mm	
L3	stripline; note 3	40 Ω	2 \times 3.25 mm	
L4, L5	stripline; note 3	40 Ω	4 \times 3.25 mm	
L6	RF choke	220 nH		
L7	stripline; note 3	40 Ω	9 \times 3.25 mm	
L8	stripline; note 3	40 Ω	3.5 \times 3.25 mm	
L9	stripline; note 3	50 Ω	9 \times 2.3 mm	
L10	stripline; note 3	50 Ω	48.5 \times 2.3 mm	
L11	stripline; note 3	40 Ω	41.5 \times 3.25 mm	
L12	grade 4S2 ferroxcube wideband RF choke			4330 030 36301
R1	metal film resistor	50 Ω ; 0.6 W		2322 156 14999
R2	metal film resistor	10 Ω ; 0.6 W		2322 156 11009

Notes

1. American Technical Ceramics type 100A or capacitor of same quality.
2. American Technical Ceramics type 100B or capacitor of same quality.
3. The striplines are on a double copper-clad PCB with PTFE fibre-glass dielectric ($\epsilon_r = 2.2$); thickness 0.79 mm.

UHF linear power transistor

BLW898

Table 1 Common emitter scattering parameter, $I_{CQ} = 1.1$ A; $V_{CE} = 25$ V.

f (MHZ)	S ₁₁		S ₂₁		S ₁₂		S ₂₂		G _{UM} (dB)
	MAG. (RAT)	ANG. (DEG)	MAG. (RAT)	ANG. (DEG)	MAG. (RAT)	ANG. (DEG)	MAG. (ANG)	ANG. (DEG)	
470	0.962	176.1	1.002	68.3	0.017	32.6	0.802	-178.2	15.7
495	0.961	175.9	0.961	66.9	0.017	32.8	0.803	-178.2	15.2
520	0.959	175.7	0.923	65.7	0.017	33.6	0.804	-178.2	14.7
545	0.958	175.5	0.891	64.4	0.018	34.9	0.803	-178.3	14.3
570	0.957	175.3	0.861	63.2	0.018	35.8	0.804	-178.2	14.0
595	0.955	175.0	0.835	62.0	0.018	36.1	0.805	-178.2	13.5
620	0.953	174.8	0.815	61.0	0.019	36.8	0.804	-178.2	13.0
645	0.951	174.5	0.795	59.7	0.019	37.3	0.805	-178.1	12.7
670	0.950	174.2	0.775	58.6	0.019	37.4	0.807	-178.0	12.5
695	0.947	173.9	0.757	57.7	0.020	37.8	0.806	-178.0	12.0
720	0.943	173.7	0.744	56.6	0.021	38.5	0.805	-178.1	11.5
745	0.942	173.4	0.732	55.4	0.021	38.6	0.807	-177.9	11.3
770	0.941	173.1	0.724	54.4	0.021	39.8	0.808	-177.8	11.1
795	0.938	172.8	0.716	53.3	0.021	40.1	0.807	-177.8	10.8
820	0.935	172.5	0.707	51.8	0.022	39.1	0.808	-177.8	10.6
845	0.933	172.1	0.701	50.9	0.021	39.3	0.810	-177.6	10.4
860	0.932	171.9	0.700	50.2	0.022	39.4	0.809	-177.5	10.3

UHF linear power transistor

BLW898

PACKAGE OUTLINE

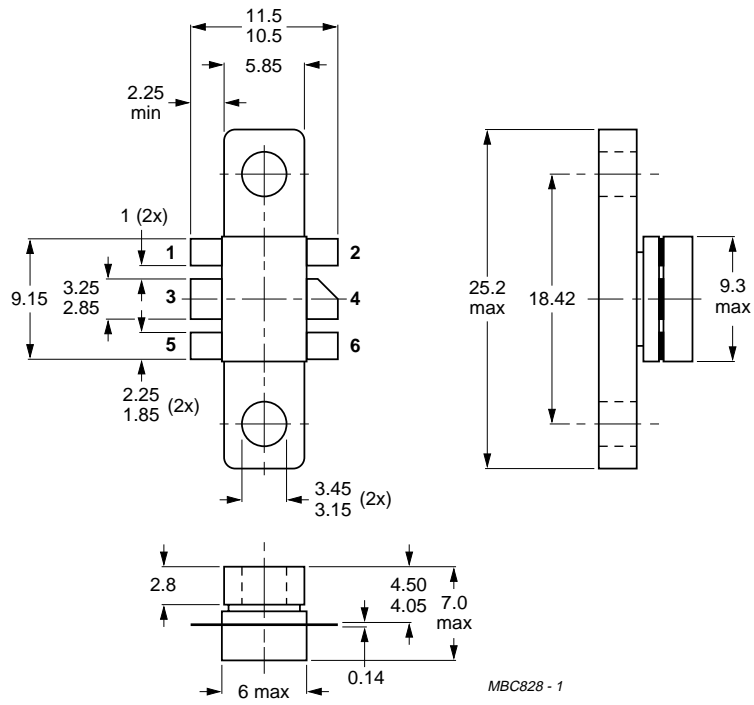

MBC828 - 1

Dimensions in mm.

Fig.11 SOT171A.

UHF linear power transistor

BLW898

DEFINITIONS

Data Sheet Status	
Objective specification	This data sheet contains target or goal specifications for product development.
Preliminary specification	This data sheet contains preliminary data; supplementary data may be published later.
Product specification	This data sheet contains final product specifications.
Limiting values	
Limiting values given are in accordance with the Absolute Maximum Rating System (IEC 134). Stress above one or more of the limiting values may cause permanent damage to the device. These are stress ratings only and operation of the device at these or at any other conditions above those given in the Characteristics sections of the specification is not implied. Exposure to limiting values for extended periods may affect device reliability.	
Application information	
Where application information is given, it is advisory and does not form part of the specification.	

LIFE SUPPORT APPLICATIONS

These products are not designed for use in life support appliances, devices, or systems where malfunction of these products can reasonably be expected to result in personal injury. Philips customers using or selling these products for use in such applications do so at their own risk and agree to fully indemnify Philips for any damages resulting from such improper use or sale.

Philips Semiconductors – a worldwide company

Argentina: see South America

Australia: 34 Waterloo Road, NORTH RYDE, NSW 2113,
Tel. +61 2 9805 4455, Fax. +61 2 9805 4466

Austria: Computerstr. 6, A-1101 WIEN, P.O. Box 213,
Tel. +43 1 60 101, Fax. +43 1 60 101 1210

Belarus: Hotel Minsk Business Center, Bld. 3, r. 1211, Volodarski Str. 6,
220050 MINSK, Tel. +375 172 200 733, Fax. +375 172 200 773

Belgium: see The Netherlands

Brazil: see South America

Bulgaria: Philips Bulgaria Ltd., Energoproject, 15th floor,
51 James Bourchier Blvd., 1407 SOFIA,
Tel. +359 2 689 211, Fax. +359 2 689 102

Canada: PHILIPS SEMICONDUCTORS/COMPONENTS,
Tel. +1 800 234 7381, Fax. +1 708 296 8556

China/Hong Kong: 501 Hong Kong Industrial Technology Centre,
72 Tat Chee Avenue, Kowloon Tong, HONG KONG,
Tel. +852 2319 7888, Fax. +852 2319 7700

Colombia: see South America

Czech Republic: see Austria

Denmark: Prags Boulevard 80, PB 1919, DK-2300 COPENHAGEN S,
Tel. +45 32 88 2636, Fax. +45 31 57 1949

Finland: Sinikalliontie 3, FIN-02630 ESPOO,
Tel. +358 615 800, Fax. +358 615 80920

France: 4 Rue du Port-aux-Vins, BP317, 92156 SURESNES Cedex,
Tel. +33 1 40 99 6161, Fax. +33 1 40 99 6427

Germany: Hammerbrookstraße 69, D-20097 HAMBURG,
Tel. +49 40 23 52 60, Fax. +49 40 23 536 300

Greece: No. 15, 25th March Street, GR 17778 TAVROS,
Tel. +30 1 4894 339/911, Fax. +30 1 4814 240

Hungary: see Austria

India: Philips INDIA Ltd, Shivsagar Estate, A Block, Dr. Annie Besant Rd.
Worli, MUMBAI 400 018, Tel. +91 22 4938 541, Fax. +91 22 4938 722

Indonesia: see Singapore

Ireland: Newstead, Clonskeagh, DUBLIN 14,
Tel. +353 1 7640 000, Fax. +353 1 7640 200

Israel: RAPAC Electronics, 7 Kehilat Saloniki St, TEL AVIV 61180,
Tel. +972 3 645 0444, Fax. +972 3 648 1007

Italy: PHILIPS SEMICONDUCTORS, Piazza IV Novembre 3,
20124 MILANO, Tel. +39 2 6752 2531, Fax. +39 2 6752 2557

Japan: Philips Bldg 13-37, Kohnan 2-chome, Minato-ku, TOKYO 108,
Tel. +81 3 3740 5130, Fax. +81 3 3740 5077

Korea: Philips House, 260-199 Itaewon-dong, Yongsan-ku, SEOUL,
Tel. +82 2 709 1412, Fax. +82 2 709 1415

Malaysia: No. 76 Jalan Universiti, 46200 PETALING JAYA, SELANGOR,
Tel. +60 3 750 5214, Fax. +60 3 757 4880

Mexico: 5900 Gateway East, Suite 200, EL PASO, TEXAS 79905,
Tel. +1 800 234 7381, Fax. +1 708 296 8556

Middle East: see Italy

Netherlands: Postbus 90050, 5600 PB EINDHOVEN, Bldg. VB,
Tel. +31 40 27 83749, Fax. +31 40 27 88399

New Zealand: 2 Wagener Place, C.P.O. Box 1041, AUCKLAND,
Tel. +64 9 849 4160, Fax. +64 9 849 7811

Norway: Box 1, Manglerud 0612, OSLO,
Tel. +47 22 74 8000, Fax. +47 22 74 8341

Philippines: Philips Semiconductors Philippines Inc.,
106 Valero St. Salcedo Village, P.O. Box 2108 MCC, MAKATI,
Metro MANILA, Tel. +63 2 816 6380, Fax. +63 2 817 3474

Poland: Ul. Lukiska 10, PL 04-123 WARSZAWA,
Tel. +48 22 612 2831, Fax. +48 22 612 2327

Portugal: see Spain

Romania: see Italy

Russia: Philips Russia, Ul. Usatcheva 35A, 119048 MOSCOW,
Tel. +7 095 926 5361, Fax. +7 095 564 8323

Singapore: Lorong 1, Toa Payoh, SINGAPORE 1231,
Tel. +65 350 2538, Fax. +65 251 6500

Slovakia: see Austria

Slovenia: see Italy

South Africa: S.A. PHILIPS Pty Ltd., 195-215 Main Road Martindale,
2092 JOHANNESBURG, P.O. Box 7430 Johannesburg 2000,
Tel. +27 11 470 5911, Fax. +27 11 470 5494

South America: Rua do Rocio 220, 5th floor, Suite 51,
04552-903 São Paulo, SÃO PAULO - SP, Brazil,
Tel. +55 11 821 2333, Fax. +55 11 829 1849

Spain: Balmes 22, 08007 BARCELONA,
Tel. +34 3 301 6312, Fax. +34 3 301 4107

Sweden: Kottbygatan 7, Akalla, S-16485 STOCKHOLM,
Tel. +46 8 632 2000, Fax. +46 8 632 2745

Switzerland: Allmendstrasse 140, CH-8027 ZÜRICH,
Tel. +41 1 488 2686, Fax. +41 1 481 7730

Taiwan: PHILIPS TAIWAN Ltd., 23-30F, 66,
Chung Hsiao West Road, Sec. 1, P.O. Box 22978,
TAIPEI 100, Tel. +886 2 382 4443, Fax. +886 2 382 4444

Thailand: PHILIPS ELECTRONICS (THAILAND) Ltd.,
209/2 Sanpavuth-Bangna Road Prakanong, BANGKOK 10260,
Tel. +66 2 745 4090, Fax. +66 2 398 0793

Turkey: Talatpasa Cad. No. 5, 80640 GÜLTEPE/ISTANBUL,
Tel. +90 212 279 2770, Fax. +90 212 282 6707

Ukraine: PHILIPS UKRAINE, 2A Akademika Koroleva str., Office 165,
252148 KIEV, Tel. +380 44 476 0297/1642, Fax. +380 44 476 6991

United Kingdom: Philips Semiconductors Ltd., 276 Bath Road, Hayes,
MIDDLESEX UB3 5BX, Tel. +44 181 730 5000, Fax. +44 181 754 8421

United States: 811 East Arques Avenue, SUNNYVALE, CA 94088-3409,
Tel. +1 800 234 7381, Fax. +1 708 296 8556

Uruguay: see South America

Vietnam: see Singapore

Yugoslavia: PHILIPS, Trg N. Pasica 5/v, 11000 BEOGRAD,
Tel. +381 11 825 344, Fax. +381 11 635 777

For all other countries apply to: Philips Semiconductors, Marketing & Sales Communications, Building BE-p, P.O. Box 218, 5600 MD EINDHOVEN, The Netherlands, Fax. +31 40 27 24825

Internet: <http://www.semiconductors.philips.com/ps/>

© Philips Electronics N.V. 1996

SCA50

All rights are reserved. Reproduction in whole or in part is prohibited without the prior written consent of the copyright owner.

The information presented in this document does not form part of any quotation or contract, is believed to be accurate and reliable and may be changed without notice. No liability will be accepted by the publisher for any consequence of its use. Publication thereof does not convey nor imply any license under patent- or other industrial or intellectual property rights.

Printed in The Netherlands

127041/1200/02/pp12

Date of release: 1996 Jul 16

Document order number: 9397 750 00966

Let's make things better.

**Philips
Semiconductors**



PHILIPS